

VERSION 5

NetWare Print Services

for UNIX

NetWare 5[™]
NETWORK SOFTWARE



Novell[®]

disclaimer

Novell, Inc. makes no representations or warranties with respect to the contents or use of this documentation, and specifically disclaims any express or implied warranties of merchantability or fitness for any particular purpose. Further, Novell, Inc. reserves the right to revise this publication and to make changes to its content, at any time, without obligation to notify any person or entity of such revisions or changes.

Further, Novell, Inc. makes no representations or warranties with respect to any software, and specifically disclaims any express or implied warranties of merchantability or fitness for any particular purpose. Further, Novell, Inc. reserves the right to make changes to any and all parts of Novell software, at any time, without any obligation to notify any person or entity of such changes.

export notice

This product may require export authorization from the U.S. Department of Commerce prior to exporting from the U.S. or Canada.

trademarks

Novell and NetWare are registered trademarks of Novell, Inc. in the United States and other countries.

A complete list of trademarks and their respective owners appears in "Trademarks" on page 509.

Copyright © 1993–1999 Novell, Inc. All rights reserved. No part of this publication may be reproduced, photocopied, stored on a retrieval system, or transmitted without the express written consent of the publisher.

U.S. Patent Nos. 5,157,663; 5,349,642; 5,455,932; 5,553,139; 5,553,143; 5,594,863; 5,608,903; 5,633,931; 5,652,854; 5,671,414; 5,677,851; 5,692,129.
U.S. and Foreign Patents Pending.

Novell, Inc.
122 East 1700 South
Provo, UT 84606
U.S.A.

NetWare Print Services for UNIX
July 1998
104-000034-001

Contents

Introduction

1 Understanding

Core Services	2
Product Kernel	2
Dispatcher	3
Administration Services	3
UNICON Utility	3
XConsole Utility	4
Other Services	5
Name Services	5
Print Services	5
File Transfer Services	6
Reverse Address Resolution Protocol Service	6
Simple Network Management Protocol Error Reporting Service	6
Name Services	7
NDS	8
Domain Name System (DNS)	9
Network Information Service (NIS)	9
How the Services Use the Information Stored in NIS	13
Setting Up Additional Servers as NIS Clients	14
Using NIS on an Existing Name Server	16
Initializing NIS on the NetWare Master Server	16
NIS Source File Updates	21
Global Objects	22
Host Information	22
Hostgroup Information	22
User and Group Information	23

Print Services	31
Print Services Overview	31
Print Service Installation	31
Print Service Access	32
NetWare-to-UNIX Print Service	32
UNIX-to-NetWare Print Service	36
FTP File Transfer Service	44
FTP Service Startup	44
FTP Service Configuration	44
NetWare NDS Access Through FTP	45
FTP Conventions	49
Name Space and File Links	52
SITE and STAT Commands	55
FTP Security Considerations	55

2 Planning

Using the Planning Worksheet	59
Understanding the Sample Planning Information	59
Sample Network Configuration	60
Installation Worksheet	61
Information Worksheet Example	62
Host Information Worksheet	64
Host Information Worksheet Example	64
User Information Worksheet	66
User Information Worksheet Example	66
Group Information Worksheet	68
Group Information Worksheet Example	68
UNIX-to-NetWare Print Worksheet	70
UNIX-to-NetWare Print Worksheet Example	70
NetWare-to-UNIX Print Worksheet	73
NetWare-to-UNIX Print Worksheet Example	73
Planning Worksheets	76
Installation Worksheet Definition Page	77
Host Information Worksheet Definition Page	79
User Information Worksheet Definition Page	81
Group Information Worksheet Definition Page	83
UNIX-to-NetWare Print Services Information Worksheet Definition Page	85
NetWare-to-UNIX Print Service Information Worksheet Definition Page	87

3 Setting Up

Installing NetWare Print Services for UNIX	89
Meeting the Installation Prerequisites	90
Preparing for Installation	90
Defining the Default NDS Context	91
Using Other TCP/IP Products	92
Reinstalling or Upgrading the Software	93
Installing the Software on a NetWare Server	94
Configuring for the First Time	98
Configuring the Name Service Database	98
Specifying Users, Groups, and Hosts	99
Adding Information with UNICON	99
Transferring UNIX Configuration Files from Another Host	99
Initializing Local Name Services	102
Initializing NIS	102
Initializing DNS	103
Mapping UNIX Accounts to NetWare Accounts	103
Converting UNIX User Accounts to NetWare User Accounts	103
Converting UNIX Groups to NetWare Groups	105
Planning Checklist	107
Configuring Global Resources	107
Configuring the NetWare-to-UNIX Print Service	108
Configuring the UNIX-to-NetWare Print Service	108
Configuring NIS	109
Configuring FTP (File Transfer Protocol) Service	109

4 Managing

Managing with the UNICON Administration Utility	111
Using the UNICON Utility	112
Authorizing UNICON Access	112
Starting the UNICON Utility	113
Using UNICON Within a Procedure	114
Using the Object Browser	115
Learning to Use the Browser	115
Using the Browser in a Procedure	116
Starting and Stopping Services	117
Services that Require Configuration	117
Services that Require No Configuration	118
Starting a Service	118

Binding the RARP Service	119
Binding RARP to a Single Media Type	119
Binding RARP to the Same Media Type at Startup	120
Binding RARP to an Unspecified Media Type.	120
Stopping a Service	121
Managing Host Information.	121
Identifying the NetWare Server as a Known Host.	122
Determining Your Host Update Rights	122
Displaying the Host Status Inset	123
Understanding the Host Status Inset	123
Using the Host Management Screens	124
Hosts List	124
Host Information Form.	125
Hostgroups List	127
Hostgroup Information List	127
Hostgroup Element Menu	128
Adding a Host in NIS	130
Displaying or Modifying Host Information in NIS	131
Deleting a Host in NIS.	132
Managing Host Group Information	133
Adding a Hostgroup	133
Adding Hosts to a Hostgroup	134
Removing Hosts from a Hostgroup	135
Deleting a Hostgroup	136
Managing User and Group Information	137
Creating User Accounts and Groups on a UNIX System	137
Determining Your User and Group Update Rights	138
Displaying the Status Inset	138
Understanding the Status Inset	138
Filtering User and Group Information	139
Displaying the Filtering Options	139
Understanding the Filtering Options.	140
Using the User Management Screens	140
User List	141
UNIX User Information Form	142
User Information Form	143
Group Membership List	145
UNIX Detailed Information Form	146
Creating User Accounts.	148
Creating a Single User Account	149
Converting UNIX Accounts to NetWare Accounts.	150

Changing Information about Users	152
Renaming a User	152
Adding a User to a Group	153
Deleting a User from a Group	154
Mapping User Accounts.	156
Deleting User Accounts	157
Using the Group Management Screens.	159
Group List	159
Group Information Form	160
User Membership List	162
Creating Groups.	163
Creating a Single Group.	164
Converting UNIX Groups to NetWare Groups.	165
Changing Information about Groups	167
Renaming a Group	167
Adding a User to a Group	168
Deleting a User From a Group	169
Mapping Groups	170
Deleting a Group	171
Managing Print Services	172
Managing the Common Print Spool Directory.	173
Using the Print Spool Directory Form	173
Moving the Print Spool Directory	174
Managing NetWare-to-UNIX Printing	175
Using the NetWare-to-UNIX Print Management Screens	175
Configuring NetWare-to-UNIX Printing.	180
Authorizing the NetWare Server to Access the UNIX Host	181
Selecting a Default Print Server.	181
Configuring the UNIX Printer	182
Identifying the Default UNIX User Account	183
Modifying a UNIX Printer	184
Deleting UNIX Printers	185
Using NPRINT.	186
Managing UNIX-to-NetWare Printing	187
Using the UNIX-to-NetWare Print Management Screens	187
Configuring UNIX-to-NetWare Printing.	196
Authorizing the UNIX Host to Access the NetWare Queue	197
Setting Up Print Job Configurations	198
Defining the Default Exported Queue Configuration	199
Exporting a NetWare Queue	200
Assigning a Default NetWare User Account.	201
Printing to Remote Print Queues	202
Modifying Exported Queue Entries	204
Deleting Exported Queues	205

Using UNIX Commands to Print	205
Slow Printing	207
Managing the Network Information Service (NIS).	208
Using the NetWare Server as the NIS Master	208
Using the NIS Administration Screens	208
Initializing the Master NIS Database	211
Managing NIS Maps.	213
Maintaining the List of Known NIS Servers	218
Backing Up the Master NIS Database.	219
Disabling the NIS Master Server	220
Enabling the Master NIS Server.	221
Setting up an NIS Master Server	222
Using a NetWare Server as the NIS Master.	222
Using a Non-NetWare Server as the NIS Master	222
Using the Server Profile Configuration Form	223
Identifying a Different NIS Server as the Master	224
Creating a Replica of the NIS Database	225
Using the Replica NIS Database Screens.	225
Creating the Replica Database	228
Deleting a Replica Database	229
Querying NIS Servers	230
Displaying the Query NIS Server Form	230
Understanding the Query NIS Server Form	230
Querying a Remote NIS Nameserver	231
Managing Shared Files and Using File Functions	232
Copying Files	232
Entering Directory Paths and Filenames	232
Using the FTP Screens	233
Connecting to One or More FTP Servers	238
Listing Remote Directories	238
Selecting the Transfer Type	239
Copying a File from a Remote Host.	240
Copying a File to a Remote Host	241
Logging Out of an FTP Server	241
Managing Directory and File Information	242
Using the Directory and File Information Screens.	242
Viewing Directory or File Information	247
Editing Files	253
Backing Up and Restoring Files.	254
Using NetWare	254
Using UNIX	254
Managing the File Transfer Protocol (FTP) Service	255

Displaying Information About Open FTP Sessions	256
Displaying the Detailed Session Statistics Form	256
Understanding the Detailed Session Statistics Form	257
Displaying Statistics for an FTP Session	258
Deleting an Open FTP Session	258
Managing User Accounts	259
Anonymous User's Home Directory Form	259
Default User's Home Directory Form	260
Setting up the Anonymous User's Home Directory	261
Disabling the Anonymous User Account	263
Setting up the Default Home Directory	263
Setting the FTP Server Parameters	264
FTP Server Parameters Form	264
Modifying the FTP Server Parameters	266
Restricting Access to FTP	267
FTP Access File	267
Defining FTP Access	270
Using the FTP Log Files	270
FTP Log File	270
Intruder Log File	271
Determining FTP Service Usage	273
Enabling Intruder Detection	273
Disabling Intruder Detection	274
Determining Unauthorized Access	275
Clearing the Log Files	275
NetWare FTP Client Usage	276
Recording the FTP Client's Address Using NetWare Auditing	276
Accessing a Remote Server	277
Accessing a Remote IBM Host	278
Using the STAT and SITE Commands	279
Changing the Server Synchronization Interval	284
Using the Server Profile Screens	285
Server Profile Form	285
Server Profile Configuration Form	287
Modifying the Synchronization Interval	288
Managing Error Reporting and SNMP Alerts	288
Managing Error Reporting	289
Using the Error Reporting Management Screens	289
Configuring Error Reporting	293
Viewing the AUDIT.LOG File	294
Backing Up the AUDIT.LOG File	295
Deleting the Contents of the AUDIT.LOG File	295
Clearing the Product Kernel Message Screen	296

Managing SNMP Reporting	296
Using the SNMP Management Screens.	297
Setting Up SNMP Alarm Reporting	301
Setting Alert Thresholds.	304
Managing Remotely	305
Managing a NetWare Server Using RCONSOLE	305
Managing a Different NetWare Server Using UNICON	305
Using the Server Login Form	305
Logging in to Another Server	307
Managing a Netware Server Using XConsole	308
Using XConsole	308
Starting and Ending an XConsole Session Using X Windows	311
Troubleshooting an X Session	313
Starting and Ending a VT100/VT220 XConsole Session	313
Using Keyboard Functions	315
Using the Control Key for Special Key Substitution	315
Using the Modifier Keys to Substitute for Function Keys	317
Removing the NetWare Print Services for UNIX Software	319
Stopping the NetWare Print Services	319
Unloading NLM Files	320
Removing the Print Services Software	320

A Administration Procedures

AIX Administration Procedures	324
Determining if NIS Is in Use on AIX.	325
Obtaining User, Group, and Host Information from NIS on AIX.	325
Determining if DNS is in Use on AIX	326
Logging in as Root on AIX	326
Identifying Your NetWare Server for AIX	327
Finding Information About a User on AIX	327
Displaying User Information	328
Compiling a List of User Names with UIDs and Primary GIDs	328
Creating a User Account and Setting a Password on AIX	329
Create User Form	329
Creating a User Account	329
Setting the New User's Password.	330
Finding Information About Groups on AIX	331
Creating an AIX Group	331
Using SMIT to Create a Group	332
Adding a Member to a Group	332

Exporting a File System from an NFS Server	333
Add a Directory to Exports List Form	333
Exporting the File System to AIX	334
Mounting a File System from AIX Machine	334
Adding a Directory to the Mount Form	335
Mounting the File System	335
Printing on AIX	336
UNIX-to-NetWare Printing	336
Troubleshooting	338
NetWare-to-UNIX Printing	340
Troubleshooting	341
HP-UX Administration Procedures	343
Determining if NIS is in Use on HP-UX	344
Obtaining User, Group, and Host Information from NIS on HP-UX	344
Determining if DNS is in Use on HP-UX	345
Logging in as Root on HP-UX	345
Identifying Your NetWare Server for HP-UX	346
Finding Information About a User on HP-UX	347
Displaying User Information	347
Compiling a List of User Names with UIDs and Primary GIDs on HP-UX	348
Creating a User Account and Setting a Password on HP-UX	348
Create User Form on HP-UX	349
Creating a User Account on HP-UX	349
Setting the New User's Password on HP-UX	350
Finding Information About Groups on HP-UX	351
Creating a Group on HP-UX	352
Adding a Member to a Group on HP-UX	353
Exporting a File System in HP-UX	354
Add a Directory to the Exports List Form	354
Exporting the File System	354
Mounting a File System on HP-UX Machine	356
Adding a Directory to the Mount Form	356
Mounting the File System	356
Printing on HP-UX	358
UNIX-to-NetWare Printing	358
NetWare-to-UNIX Printing	360
NeXT Administration Procedures	362
Determining if NIS is in Use on NeXT	363
Obtaining User, Group, and Host Information from NIS on NeXT	363
Determining if DNS is in Use on NeXT	364
Logging in as Root on NeXT	364
Accessing the NeXT Administration Tools	365

Identifying Your NetWare Server for NeXT	365
Finding Information About a User on NeXT	366
Finding Information about a User with a NeXT Account Name	366
Compiling a List of User Names with UIDs and Primary GIDs in NeXT.	368
Compiling Local User, Group, and Hosts Files from the NeXT Database	368
Creating a User Account and Setting a Password on NeXT	369
Finding Information About Groups on NeXT	370
Finding Information about a Group Name	370
Compiling a List of Group Names and GIDs in NeXT.	371
Creating a NeXT Group	372
Exporting a File System in NeXT	373
Mounting a Remote File System from NeXT Machine	374
Printing on NeXT	375
Printcap File Format	375
UNIX-to-NetWare Printing	376
NetWare-to-UNIX Printing	378
SCO Administration Procedures	383
Determining if NIS is in Use on SCO	384
Obtaining User, Group, and Host Information From NIS on SCO.	384
Determining if DNS is in Use on SCO.	385
Logging In as Root on SCO	385
Identifying Your NetWare Server for SCO	385
Finding Information About a User on SCO	386
Finding User Information with a UNIX Account Name	386
Finding User Information with a User's Full Name	387
Compiling a List of User Names with UIDs and Primary GIDs	387
Creating a User Account and Setting a Password on SCO	388
Creating a User Account	388
Setting a User's Password	390
Modifying Existing User Information.	390
Finding Information About Groups on SCO	391
Creating a SCO Group	392
Setting Up the /etc/group File	392
Adding a Member to a Group	393
Exporting a File System in SCO	394
Setting Up the /etc/exports File	394
Examples	395
Mounting a Remote File System	396

Printing on SCO	396
Notice About TCP/IP Versions Older than 1.2	396
Printcap File Format	397
Prerequisites	398
UNIX-to-NetWare Printing	398
NetWare-to-UNIX Printing	400
Solaris Administration Procedures	403
Determining if NIS Is in Use on Solaris	404
Obtaining User, Group, and Host Information from NIS on Solaris	404
Determining if DNS is in Use on Solaris.	405
Logging In as Root on Solaris.	405
Identifying Your NetWare Server for Solaris	406
Finding Information About a User on Solaris	407
Displaying a List of Users and UIDs.	407
Finding User Information with a UNIX Account Name	408
Finding User Information with a User's Full Name	409
Compiling a List of User Names with UIDs and Primary GIDs	409
Creating a User Account and Setting a Password on Solaris.	410
Creating a User Account	410
Setting a Password for the New Account	411
Finding Information About Groups on Solaris.	412
Creating a Solaris Group	412
Creating a Group	413
Adding a Member to a Group	414
Exporting a File System on Solaris	415
Using the share Command to Export a File System	415
Examples	416
Mounting a File System from a Solaris Machine	416
Setting Up the /etc/fstab File	417
Using the mount Command	417
Printing on Solaris.	418
UNIX-to-NetWare Printing	418
NetWare-to-UNIX Printing	420
Troubleshooting	422
SunOS Administration Procedures	423
Determining if NIS is in Use on SunOS	424
Obtaining User, Group, and Host Information from NIS on SunOS.	424
Determining if DNS is in Use on SunOS	425
Logging in as Root on SunOS	425
Identifying Your NetWare Server for SunOS	426

Finding Information About a User on SunOS	427
Finding User Information with a UNIX Account Name	427
Finding User Information with a User's Full Name	428
Compiling a List of User Names with UIDs and Primary GIDs	428
Creating a User Account and Setting a Password on SunOS	429
Creating a User Account	429
Setting a Password for the New Account	430
Finding Information About Groups on SunOS	430
Compiling a List of Groups and GIDs	430
Creating a SunOS Group	431
Setting Up the /etc/group File	431
Adding a Member to a Group	432
Exporting a File System on SunOS	433
Setting Up the /etc/exports File.	433
Examples	434
Effecting Changes to exports File	435
Mounting a File System from a SunOS Machine.	435
Setting Up the /etc/fstab File	435
Using the mount Command	436
Printing on SunOS	436
Prerequisites	436
Printcap File Format	437
UNIX-to-NetWare Printing.	438
NetWare-to-UNIX Printing.	439
System V Administration Procedures	440
Determining if NIS is in Use on System V	441
Obtaining User, Group, and Host Information from NIS on System V	441
Determining if DNS is in Use on System V.	442
Logging In as Root on System V.	442
Identifying Your NetWare Server for System V	443
Finding Information About a User on System V	444
Finding User Information Using the Administration Tool	444
Finding User Information with an Account Name	445
Finding User Information with a User's Full Name	446
Compiling a List of User Names with UIDs and Primary GIDs	446
Creating a User Account and Setting a Password on System V.	447
Creating a User Account	447
Setting a Password for the New Account	448
Finding Information About Groups on System V.	449
Compiling a List of Groups and GIDs	449
Displaying a List of Groups and GIDs	450

Creating a System V Group	450
Creating a Group	451
Adding a Member to a Group	451
Exporting a File System on System V	452
Mounting a File System from a System V Machine	453
Printing on System V	454
UNIX-to-NetWare Printing	454
NetWare-to-UNIX Printing	457
ULTRIX Administration Procedures	458
Determining if NIS is in Use on ULTRIX	459
Obtaining User, Group, and Host Information from NIS on ULTRIX	459
Determining if DNS is in Use on ULTRIX	460
Logging In as Root on ULTRIX	460
Identifying Your NetWare Server for ULTRIX	461
Finding Information About a User on ULTRIX	461
Finding User Information with an Account Name	462
Finding User Information with a User's Full Name	463
Compiling a List of User Names with UIDs and Primary GIDs	463
Creating a User Account and Setting a Password on ULTRIX	464
Creating a User Account	464
Setting a Password for the New Account on ULTRIX	465
Finding Information About Groups on ULTRIX	465
Creating an ULTRIX Group	466
Setting Up the /etc/group File	466
Adding a Member to a Group	467
Exporting a File System on ULTRIX	468
Setting Up the /etc/exports File	468
Examples	469
Mounting a File System from an ULTRIX Machine	470
Setting Up the /etc/fstab File	470
Using the mount Command	470
Printing on ULTRIX	471
Prerequisites	471
Printcap File Format	472
UNIX-to-NetWare Printing	473
NetWare-to-UNIX Printing	474
UnixWare Administration Procedures	475
Determining if NIS is in Use on UnixWare	476
Obtaining User, Group, and Host Information from NIS on UnixWare	476
Determining if DNS is In Use on UnixWare	477
Logging in as Root on UnixWare	477
Accessing the UnixWare Administration Tools	478

Identifying Your NetWare Server for UnixWare	478
Finding Information About a User on UnixWare	479
Finding User Information Using the Administration Tool	479
Finding User Information with a UNIX Account Name	480
Finding User Information with a User's Full Name	481
Compiling a List of User Names with UIDs and Primary GIDs on UnixWare.	481
Creating a User Account and Setting a Password on UnixWare.	482
Finding Information About Groups on UnixWare.	483
Finding Group Information with a UnixWare Group Name	483
Compiling a List of Groups and GIDs	484
Creating a UnixWare Group	485
Creating a Group	485
Adding a Member to a Group	486
Exporting a File System on UnixWare	487
Mounting a File System from a UnixWare Machine	488
Printing on UnixWare	490
UNIX-to-NetWare Printing.	490
NetWare-to-UNIX Printing.	491
Troubleshooting	493

B Parameters

LPR_GWY	495
FTP Server.	500
NetDB	504
NIS	505
PLPD.	508

Trademarks

Novell Trademarks	509
Third-Party Trademarks	516

Introduction

Welcome to NetWare® Print Services for UNIX*. The NetWare Print Services product extends NetWare print services to the UNIX environment and vice versa. Using this product, UNIX clients can access NetWare printers and NetWare clients can access UNIX printers transparently. The NetWare Print Services for UNIX product provides the same services as the NetWare Communication Services product, with the exception of file sharing.

Understanding

The print services product includes a number of different modules that work together to provide the print services. Each service is identified and described in the following sections.

This product provides the following network services:

- ◆ Administration
- ◆ Name management
- ◆ Printing
- ◆ File transfer
- ◆ Reverse address resolution
- ◆ Simple Network Management Protocol (SNMP) error reporting

Core Services

Core services provide the essential communication between the modules that work together to provide the print services. Two core services are essential to the operation of this product:

- ◆ Product kernel
- ◆ Dispatcher

These services are described in the following sections.

Product Kernel

The product kernel (pkernel) provides communication routing between services and access to the network. The product kernel also integrates all UXPS products running on the same server.

During installation, the installation program copies the PKERNEL NetWare Loadable Module™ (NLM) software to the SYS:/SYSTEM directory on the NetWare server. After installation, PKERNEL.NLM loads automatically when the server starts.

The product kernel provides the following functions:

- ◆ Product communication
The product kernel integrates network and product communication for all NFS products.
- ◆ Registration
The product kernel registers newly installed NFS products with the system for identification purposes. The system also uses this registration process for license administration.
- ◆ Error message audit logging
The product kernel can send messages to a file, to the product message screen, or to both. The product message screen is one of the displays on the server console.

Dispatcher

The dispatcher routes requests from the UNICON administration utility to the services that do the actual work.

Administration Services

Administration services enable you to manage all of the NetWare Print Services using two utilities, the UNICON utility and the XConsole utility.

- ◆ UNICON utility—a menu-driven utility that provides NetWare Print Services administration.
- ◆ XConsole utility—a connection utility that provides access to the NetWare server console from remote workstations.

These utilities are described in the following sections.

UNICON Utility

The UNICON utility provides menu-driven administration. This utility enables you to do the following:

- ◆ Manage specific NetWare Print Services products
- ◆ Start and stop services running on the NetWare server
- ◆ Manage the NIS database
- ◆ Manage and map the accounts of NetWare users and NFS users that need access to shared files and print services
- ◆ Control access to other computers on the network through host address management
- ◆ Configure system error reporting and view and clear error logs
- ◆ Monitor performance statistics
- ◆ Log in to the current server or another NetWare Print Services server without leaving the UNICON utility

- ◆ Copy files to and from a remote server
- ◆ View file permissions from both the NetWare and NFS name spaces
- ◆ Edit text files on the NetWare Print Services server
- ◆ Delegate management tasks by assigning persons to management groups that allow access to related UNICON menu options

For more information on using the utility and delegating management tasks, see “Managing with the UNICON Administration Utility” on page 111.

XConsole Utility

The XConsole utility provides remote access to the NetWare server console from any workstation running the X Window System*, from any VT100*/220 terminal, or from a terminal that emulates a VT100/220. NetWare provides the keyboard functions, basing the key assignments on the IBM Enhanced PC keyboard (101 keys). However, XConsole can accommodate other types of keyboards.

XConsole supports all of the operations that the server console can perform. The display for an XConsole session looks exactly like the NetWare console display. When XConsole operates in an environment that permits multiple sessions (such as an environment that includes X Windows), you can open multiple XConsole sessions, either to a single NetWare server or to multiple servers.

XConsole uses the TELNET protocol both to connect to the NetWare server and, if your session is a VT100/220 session, to maintain the connection. The X Window System* maintains X Window connections.

For more information on using XConsole, see “Managing Remotely” on page 305.

Other Services

The NetWare™ Print Services product can provide a number of other services. Some services are required, while others are optional.

Name Services

Name services provide a centralized database that maintains and manages configuration information. This product uses three name services:

- ◆ Network Information Service (NIS)—a centralized database that stores user, group, host, hostgroup, and mapping information.
- ◆ Domain Name System (DNS)—a centralized database that stores host information.
- ◆ NDS™—a database that provides access to all objects defined in the NDS tree.

This product requires both the NIS and DNS name services. If your network includes machines running NIS and DNS, you can choose to use those machines to provide the service. Together with NIS and DNS, this product also uses the existing NDS provided with NetWare.

For more information on the name services, see “Name Services” on page 7.

Print Services

Print services provide users with access to remote printers. This product provides the following print services:

- ◆ UNIX*-to-NetWare Print Service—enables UNIX users to print to a NetWare printer.
- ◆ NetWare-to-UNIX Print Service—enables NetWare users to print to a UNIX printer.

For more information on using print services, see “Print Services” on page 31.

File Transfer Services

File transfer services enable users to transfer files between file systems. This product provides the following file transfer services:

- ◆ **FTP Server**—enables UNIX users to transfer files to and from the NetWare FTP server. Users can also transfer files to and from a NetWare server that is not running FTP.
- ◆ **TFTP Server**—enables UNIX users to transfer files to and from the NetWare server without username authentication. Because the TFTP server requires no password or account information, the TFTP client can only access files that are readable by all users on the system.

For more information on using the FTP service, see “FTP File Transfer Service” on page 44.

Reverse Address Resolution Protocol Service

The Reverse Address Resolution Protocol (RARP) service provides IP address to physical address mapping by maintaining a mapping table. The RARP service uses this mapping table to do the following:

- ◆ Provide IP address to physical address mapping
- ◆ Provide a workstation with an IP address when booted

This service requires no configuration or management. For more information on starting the RARP service, see “Starting and Stopping Services” on page 117.

Simple Network Management Protocol Error Reporting Service

The Simple Network Management Protocol (SNMP) error reporting service notifies the network manager when system problems occur. The level of SNMP reporting and the level of messages sent to SNMP management stations is set using the UNICON utility.

The SNMP error reporting service sends SNMP alerts to configured SNMP management stations. The service also incorporates all SNMP events into the UXPS error reporting system so that the events display as local system error messages. The system automatically converts SNMP events to system error messages even if the SNMP reporting level is set to None.

For more information on setting up SNMP error reporting, see “Managing Error Reporting and SNMP Alerts” on page 288.

Name Services

Name services provide other computers on a network with a way to access database information that exists on a central server. Using the name services, each computer can locate the other computers on the network and obtain configuration information about users, groups, and hosts.

Databases are categorized into two primary types, distributed and local. A *distributed database* maintains information on one server and shares the information with the other computers that request it. A *local database* does not share information with other computers. It consists of individual files, known as local files, that each computer maintains for itself. Both database types can contain the same configuration information, such as users, groups, and hosts.

Distributed computing systems commonly use a distributed database and a name service that functions as a centralized management facility. This product uses the following distributed name service databases:

- ◆ NDS™
- ◆ Domain Name System (DNS)
- ◆ Network Information Service (NIS)

Important: This product requires each of these name services to obtain the information that enables the print services to operate. This product cannot operate without the name services.

This section describes each name service and explains how this product uses the information the name services provide.

NDS

NDS is the distributed database built into NetWare®. Using NDS, the print services can access relevant objects in the NDS tree.

Overview of NDS

NDS is a global, distributed database that maintains information about, and provides access to, every resource in the network. Using NDS, NetWare users and services can access any NDS object from one location.

For a more detailed description of NDS, refer to the NetWare 5 documentation.

Information Stored in NDS

Although NDS provides access to all the objects in the NDS tree, this product uses NDS to access only the following objects:

- ◆ Users
- ◆ Groups
- ◆ Computers
- ◆ Print queues
- ◆ Printers

The UNICON utility enables you to manage all of these objects without returning to the NetWare Administrator utility.

How the Print Services Use the Information Stored in NDS

During configuration, the print services can use existing NDS objects or create new NDS objects. If one of the print services creates a new object, the service adds the new object to the NDS tree automatically. The UNICON utility enables you to manage NDS objects during configuration and management using a tool called the *object browser*.

The UNICON object browser enables you to navigate the NDS tree so that you can view, select, create, and delete NDS objects. For more information on the object browser, which functions similarly to the NETADMIN (a NetWare 4 utility) browse screen, see “Using the Object Browser” on page 115.

Domain Name System (DNS)

DNS is a distributed database that provides host information. Using DNS, the print services can locate other computers on the network. The DNS service this product uses can run on the NetWare server or on another machine running DNS.

For information on DNS, refer to *Novell DNS/DHCP Services Administrator's Guide*.

Network Information Service (NIS)

NIS is a distributed database that provides common information such as information about users and groups. Using NIS, the print services obtain information about users and groups from a central location. The NIS service this product uses can run on the NetWare server or on another machine running NIS.

Before installing the software, you must choose whether to run NIS on the NetWare server or use an existing NIS service running on another machine in your network. If an NIS service that contains all of your user and group information exists, you can use it by entering the appropriate information during installation. If you choose to use the NetWare NIS service, it can provide service for other NetWare servers running this product and for UNIX workstations.

Important: If you choose to use an existing NIS service, you must manage all database information on the master name server. For more information on using an existing name service, see “Using NIS on an Existing Name Server” on page 16.

Overview of NIS

NIS is a naming system that provides common information such as user and group mappings, which the system uses to validate users who want to use the print services. NIS stores this common configuration information in keyword and value pair tables called *NIS maps*. NIS maintains all maps in a single location, called the *master NIS server*.

The master NIS server contains all the authoritative maps for an administrative segment called an *NIS domain*. An NIS domain consists of a set of NIS maps and the hosts using the information contained in the maps. Each domain maintains all map information on the master NIS server and then makes the information available to the other machines within the domain through a client-server relationship.

The following sections provide more detailed descriptions of the NIS components.

NIS Domains

The NIS system organizes nodes into administrative segments called domains. An NIS domain is different from a DNS domain because it is a flat, rather than hierarchical, structure. An NIS domain exists only in the local environment and usually covers a single network. NIS does not impose any strict rules on domain naming; however, each domain must have a unique name. Many administrators using DNS choose to relate their NIS domain name to their DNS domain name.

Note: An administrative NIS domain could be a company or a division of a company. It could be the same as a DNS domain, but this is not necessary.

NIS Master Server

One NIS server maintains an authoritative database of NIS maps for an NIS domain. The domain administrator updates this NIS server, referred to as the *master NIS server*, as configuration information changes within the domain. The administrator must make all modifications on the master.

NIS Replica Servers

For reliability and load balancing, NIS enables the administrator to set up read-only copies of the NIS database on secondary servers. The NetWare NIS service calls the secondary servers *replicas*. (Standard NIS services call the secondary servers “slaves.”) When the replica NIS server starts up, it contacts the master server and requests a complete copy of the NIS maps on that server.

Once the replica server is set up, it is not necessary to manage the update process manually. The replica servers periodically query the master and request an update when the replica detects a more recent time stamp on the master. If you make a number of changes to the master, the UNICON utility enables you to update the replica servers immediately. This process is called *propagating the replica domains*.

Propagating the replica domains is effective only when the master contains a current list of the replica servers within the domain. NIS maintains this list in the NIS map named *ypservers*. Each time you add a replica server to the domain, you must also update the *ypservers* map on the master using the UNICON utility. This process is called *maintaining the list of NIS servers*.

It is important to set up at least one replica server for each NIS domain. The replica can then function as a backup if the master server goes down. Although it may not be necessary in all networks, a master NIS server for one domain can also function as a replica NIS server for another domain.

Information Stored in NIS

NIS stores common configuration information in keyword and value pair tables called *NIS maps*. The NetWare NIS server creates the NIS maps from specific configuration files during installation or when you reinitialize the NIS database. After the master server creates the maps, it updates them automatically each time you modify the configuration information using the UNICON utility.

The NetWare NIS server supports both standard NIS maps and custom maps.

Standard NIS Maps

The NIS server automatically creates a number of standard NIS maps from a few standard configuration files. The NIS master may create more than one map from each standard configuration file. For example, the NIS master converts the information from the group file into two different maps: one that looks up a group according to name, and one that looks it up according to Group Identification Number (GID).

Each time you update user, group, or hostgroup information using the UNICON utility, the NIS server updates the NIS maps automatically. It is also possible to modify the NIS map text files manually using a text editor. If you want to modify a map manually, you must save it to a text file, edit it with a text editor, and then use the UNICON utility to convert it back into an NIS map within the master database. You must use the same process if you decide to create custom NIS maps as described in the following section.

Custom NIS Maps

You can use NIS to store any common configuration information that is valuable to NIS clients. Maps you create in addition to the standard NIS maps are called custom maps. You create custom maps by creating a text file that contains the relevant configuration information. After you create the text file, you convert it into an NIS map using the UNICON utility. For example, you might want to create an NIS map that provides employee mailstop addresses.

To create a mailstop map, you would begin by creating a text file containing each employee's name and mailstop address. An NIS map text file must conform to the following rules:

- ◆ Each data line begins a new entry key.
- ◆ The backslash character (\) at the end of line appends the next line to the current line.
- ◆ The pound sign (#) at the beginning of a line tells the converter to ignore the line.

- ◆ Blanks separate the key and the value. Therefore, you must use underscores to replace all other blanks within the key, such as the space between an employee's first and last name. Blanks are acceptable within the key values such as the mailstop.

The following is an example of the mailstop text file:

```
# This is the text file for the mailstop map.
```

```
Janice_SmithMS F1 42-C2
```

```
Bob_SpillerMS F3 43-G2
```

```
Jim_Miller MS F3 51-J3
```

After you create the map, you use the UNICON utility to convert it into an NIS map.

NIS Management Using the UNICON Utility

The NetWare NIS service provides all the functionality of a standard NIS service without complex configuration and management. Using the UNICON utility, you can accomplish all NetWare NIS tasks by selecting options from a series of menus instead of editing configuration files.

How the Services Use the Information Stored in NIS

The NIS database stores the user and group information for clients that need access to the print services. The NIS database also stores hostgroup information. The NetWare Print Services use this information to allow access to the services as well as to grant permissions to specific files and directories. User, group, and hostgroup information consists of a number of different facts. For detailed information about user, group, and hostgroup information, see "Global Objects" on page 22.

Figure 1-1 on page 14 shows the specific NIS information used by the NetWare Print Services product.

Figure 1-1
NIS Information Used by the Services

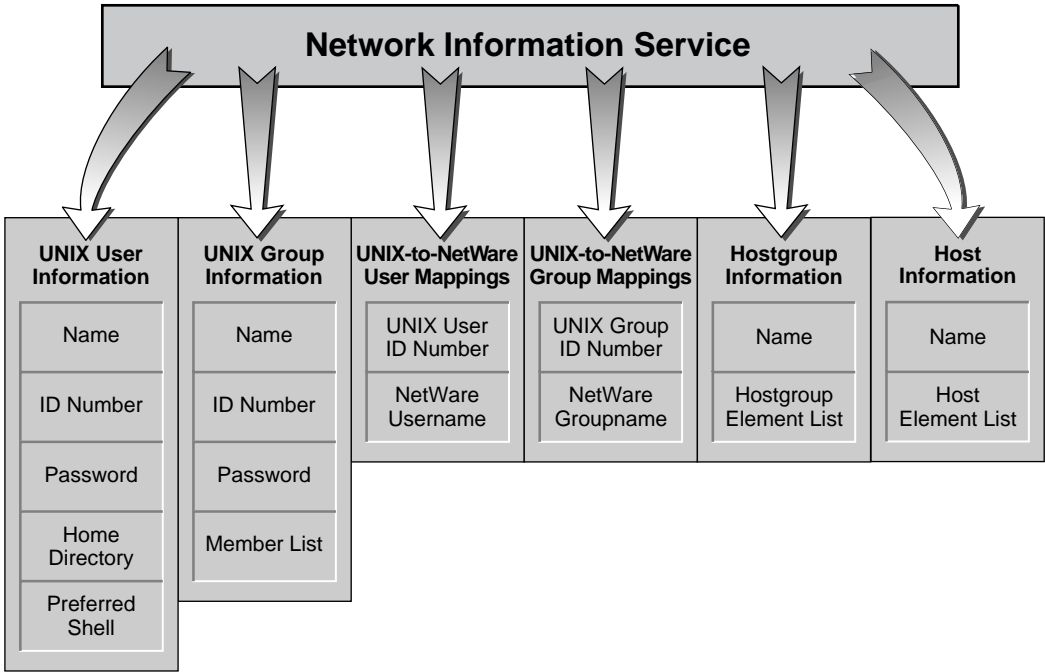

Setting Up Additional Servers as NIS Clients

If you run additional NetWare Print Services servers in the same domain, only one of them should be set up as the NIS master. You can then set the additional servers to access the information located on the master, as shown in Figure 1-2 on page 15. This provides all the NetWare Print Services servers with the same configuration information. You can also set up other UXPS servers and UNIX machines to use the NetWare master.

During installation, you can choose to use or *point to* existing NIS name server. The installation program does not create the NIS database on the local machine if you indicate that a different machine is running the NIS service.

You can modify a NetWare master database remotely from another NetWare Print Services server by logging in to the master server using the UNICON utility. The utility then transfers management control to the master server running the NIS service.

Figure 1-2
Additional Servers Accessing One Database as Clients

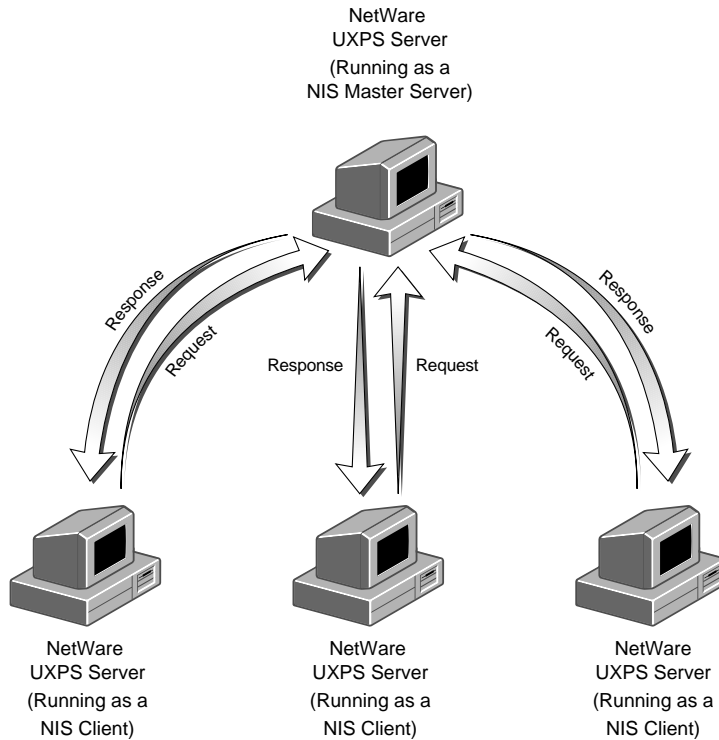

Using NIS on an Existing Name Server

The NetWare Print Services server can obtain NIS information from another NetWare server or a non-NetWare server functioning as a master name server. You can choose the existing NIS server during the name service portion of the installation or choose it after installation using the UNICON utility. The following configurations are possible:

- ◆ Local NIS on the NetWare server

This configuration allows you to update and manage the NIS database using the UNICON utility. Once you configure one NetWare server as the master, it can provide information to any additional UXPS servers.

- ◆ Remote NIS

This configuration does not allow you to update or manage the NIS database using the UNICON utility, unless the remote services run on a NetWare server. The UNICON utility displays the user, group, and host information stored on the master, but does not allow modification. You must manage all user, group, and host information on the master.

Initializing NIS on the NetWare Master Server

By default, the installation program sets up the NetWare Print Services server as the master NIS server of its own domain. The default NIS domain name is the hostname of the NetWare Print Services server on which the software is running.

The NetWare Print Services server creates the standard NIS database from local files. On UXPS systems, these local files are in the `/etc` directory. On the NetWare Print Services server, the system copies the local files to a special directory and creates the NIS database from these transferred files. You do not need to update the local files under `SYS:ETC` after creating the NIS database, unless you want to use the local files to override an entry in one of the databases.

Note: Local files override a database entry only on the local server where the files exist.

Using Local Configuration Files During Initialization

The installation process creates the NIS database automatically from the local configuration files. If these files do not exist, the installation program creates them. The newly created files are either empty or they contain a few default entries. You must then use the UNICON utility to add additional entries after the installation program creates the databases.

If you install the software on a NetWare server that has no local configuration files in the SYS:ETC directory, or if you want to create the database from source files on another server, you can obtain these files after installation using the UNICON utility. For the step-by-step process for transferring the configuration files from another server, see “Configuring for the First Time” on page 98.

Transferring Configuration Files from a Remote Server

Transferring the configuration files from a remote NFS/UXPS server is the most efficient method for creating a populated NIS database. Before you transfer the files, you must identify the correct source files on your UXPS server. Most NFS UNIX-based systems make use of the standard configuration files listed in this section, but the implementation of NFS at your site may be different. If the following source files do not exist, refer to your operating system manuals for the names of the configuration files that contain the appropriate configuration information.

You copy the following database source files from the UXPS server’s /etc directory to the NetWare SYS:ETC\DBSOURCE directory under \NIS:

- ◆ hosts—lists the IP address and hostname for each host computer.
- ◆ passwd—contains each user’s login name, user identification number (UID), and primary group identification number (GID) as well as the user’s full name and the user’s home directory.
- ◆ group—contains groupnames and the GID and user list for each group.

Figure 1-3 on page 18 illustrates this process.

Figure 1-3
Source Files Used to Create the NIS
Database

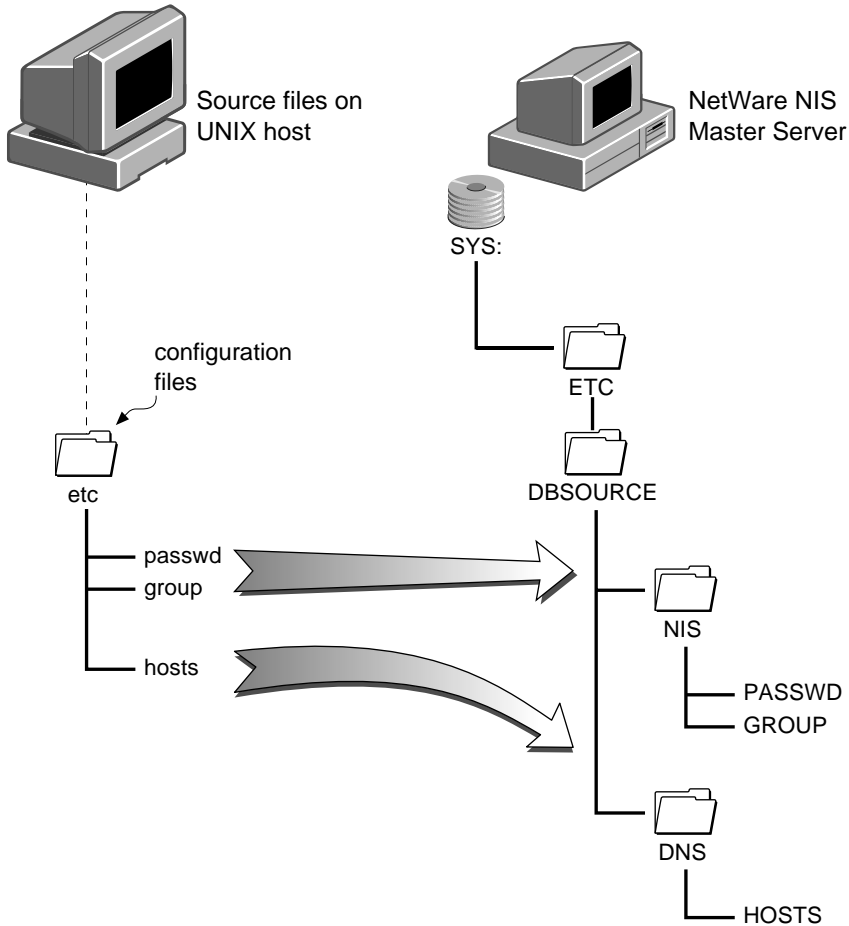

If a file is less than 64 KB, you can use the UNICON utility to edit out unnecessary entries in the files after you copy them to the NetWare Print Services server. You must edit larger files with a text editor. After you transfer and edit the files, you must convert them into the NIS databases.

Conversion Process

The process for converting the source files into databases is shown in Figure 1-4 on page 20. First, the system searches for the source files under the subdirectory SYS:ETC\DBSOURCE. If the system does not find the files, the system searches for the files in the SYS:ETC directory.

If the conversion process copies the source files from the SYS:ETC directory to the DBSOURCE subdirectory, the local files and the databases would then contain the same information. The conversion process deletes the contents of the local files in the ETC directory to remove redundancy unless you set the compatibility mode before you install the product. You set the compatibility mode when the server runs other TCP/IP products that use local configuration files. For more information on the compatibility mode, see “Using Other TCP/IP Products” on page 92.

If an older version of the software also runs on the server, two other source files should exist in the ETC directory that map NFS users and NetWare users and groups. These files are named NFSUSERS and NFSGROUP. The UXPS server takes advantage of this source information and adds the same mappings to the NetWare NIS database. These files are also copied to the DBSOURCE directory so that you can edit them before conversion.

Figure 1-4
Conversion of Source Files to the NIS Database

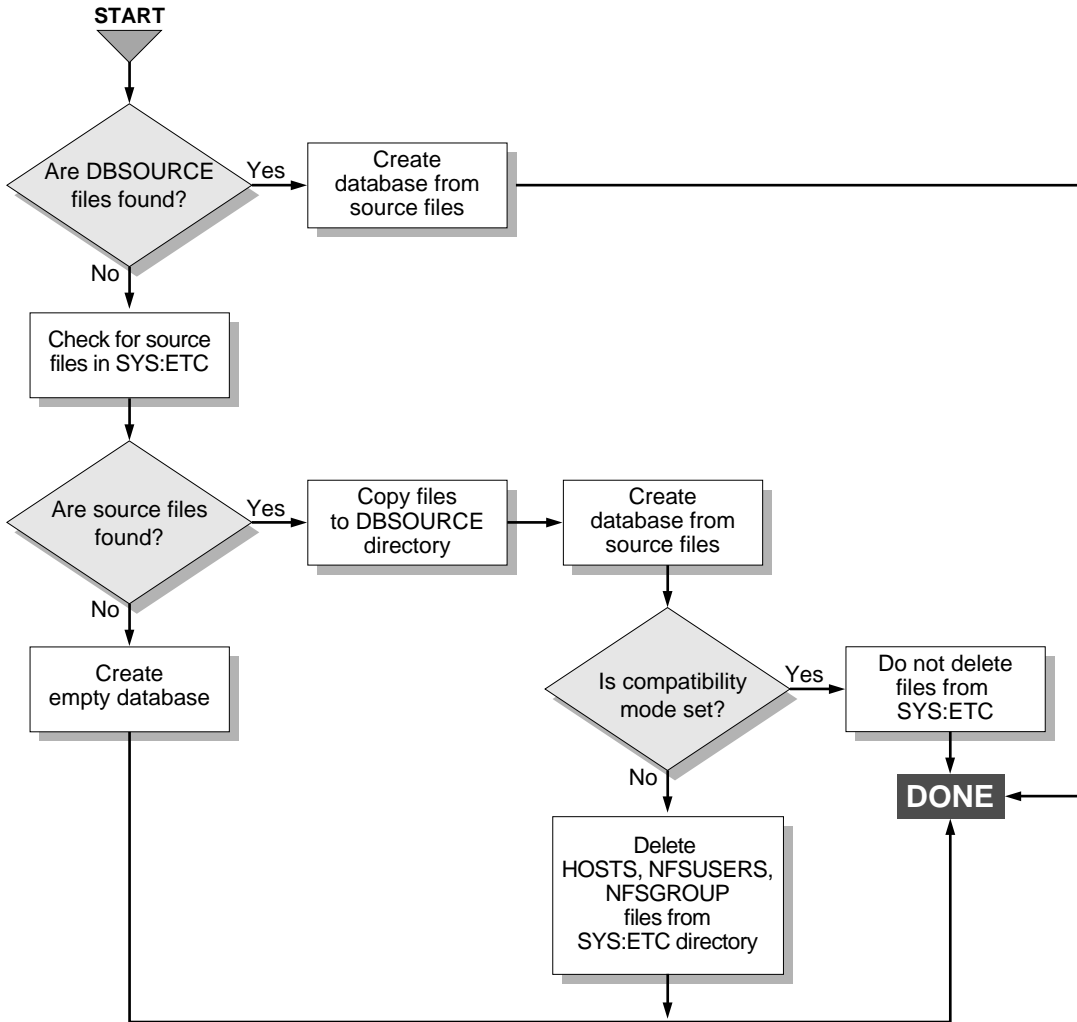

NIS Source File Updates

You use the UNICON utility to update the database source files. To back up the database itself, you should use the NetWare SBACKUP utility.

Updating Source Files

The source files the system uses to create the NIS databases are located in the `SYS:ETC\DBSOURCE\NIS` directory. When you change the configuration of users, groups, or hosts, the UNICON utility automatically updates the database, but these changes are not reflected in the source files. Therefore, you may want to update the source files manually, using the UNICON utility, so that the file content matches the database content. This is particularly important if you need to reinitialize the databases as described in the next section. When you reinitialize the NIS databases, the system obtains its information from the source files.

Converting the Databases Into Text Files

You update the local source files by converting the databases into text files. When you use the UNICON utility to convert the databases to text files, the utility reproduces the database information in its original source form by writing it back to the source files in the `DBSOURCE` directory. You may want to do this for one of the following reasons:

- ◆ You want to use the updated source files to build an NIS database on another server. You can then transfer the source files to another server using the File Operations option of the UNICON utility.
- ◆ You want to recreate a corrupt NIS database. You can then recreate the databases using the Reinitialize Database option of the UNICON utility.
- ◆ You want to create a backup copy of the databases.

Global Objects

The name service databases store the following global objects, which are essential to the operation of this product:

- ◆ Hosts
- ◆ Hostgroups
- ◆ Users
- ◆ Groups

This section describes each global object and how the NFS services use the object.

Host Information

For documentation on Host Information, refer to *Novell DNS/DHCP Services Administrator's Guide*.

Hostgroup Information

A *hostgroup* is a collection of hosts, or an administrative group. The UNICON utility enables you to specify a hostgroup in place of an individual host when it is appropriate. Specifying a hostgroup saves you the time involved in listing each host individually. For example, you can create a hostgroup that includes all the hosts in the marketing group. Then, when you specify which UNIX hosts can access an exported NetWare volume or print queue, you can specify the hostgroup instead of listing each host in the marketing group separately.

Hostgroups exist in the NIS database and can include one or more of the following elements:

IP address—the Internet address, which identifies a host on an IP network.

DNS domain—a group of computers sharing the same DNS master.

Host—the hostname of a computer.

Hostgroup—a group of hosts, which can consist of hosts, hostgroups, IP addresses, and DNS domains.

The UNICON utility enables you to view and modify hostgroups.

Note: This product maintains hostgroups in an NIS map, which is supported by the NetWare NIS server only. Therefore, if you use a non-NetWare NIS server, the software maintains hostgroup information in a local file.

User and Group Information

The NetWare system identifies users by the username that exists in the NIS database. NIS contains all the user information necessary for managing access to the UXPS services. If you create a NetWare user account or group using the UNICON utility, the utility automatically adds the new NetWare account or group to NDS™ as well as to NIS. If you create a UNIX user account, the utility automatically adds the new account or group to NIS, but does not create the UNIX user on the remote UNIX machine unless the UNIX machine uses the NetWare server as its NIS master.

When a user makes a request to access one of the UXPS services, the NetWare Print Services server checks to see that the user has an account on both the remote UXPS server and the local NetWare server. Therefore, both NetWare and UXPS users need to have a NetWare and UXPS account on the NetWare Print Services server. The same requirement applies to users who access services as members of a group.

Information About NetWare Users and Groups

When you first install this product, all user accounts and groups that exist in the current NDS context exist as valid users and groups in the NIS database. You can view these users and groups in the user or group list using the UNICON utility. If you do not accept the default installation, your NIS database will contain different user and group information.

If you point to an existing NIS database during installation, the user and group lists within the UNICON utility will reflect the contents of the remote NIS master along with the NetWare users and groups that exist in the default context.

If you select the default installation (local NIS and DNS) and then copy over existing UNIX configuration files from another server (as described in “Transferring UNIX Configuration Files from Another Host” on page 99), the user and group lists within the UNICON utility will reflect both the NetWare context information and the UNIX information.

In either case, you should end up with a complete user and group list that contains a NetWare account and a corresponding UNIX account for each user and group needing access to the NFS services. The correspondence between the NetWare and UNIX account is called a *mapping*. A mapped account must exist for each user and group accessing the NFS services.

Information About NetWare Users

Although all NetWare users within the default NDS context are valid users and visible in the user list after you install the product, other NetWare users located within another context are not available by default. You can add a NetWare user from a different context to the list of valid NFS services users by using the object browser provided with the UNICON utility. After you add or *import* the user from another context, you must create a corresponding UNIX user account and then map the accounts as described in “Mapping User Accounts between NetWare and NFS” on page 29. If you do not create the corresponding UNIX user account, the new user will not have access to the NetWare Print Services.

Note: When you import a user from another context, the user’s complete NDS username appears in the user list relative to the default NDS context.

In addition to the existing NetWare user accounts, two other usernames already exist in NDS:

- ◆ ADMIN (or admin equivalent)—username for the network administrator or system administrator. If the ADMIN account resides in a different organizational unit (OU), you must import the account to access it from UNICON.
- ◆ GUEST—username for anyone requiring temporary and limited access. You can use the guest account within specific services, such as printing, when you want all users to have access to a service.

Information About NetWare Groups

As with NetWare user objects, NetWare groups within the default NDS context are valid and visible in the group list after you install the product. However, other NetWare groups located within another context are not available by default. You can add a NetWare group to the list of valid NFS services groups by using the object browser provided with the UNICON utility. After you add or *import* a group from another context, you must create a corresponding UNIX group that contains the same users as the NetWare group as described in “Mapping Groups between NetWare and NFS” on page 30. (These users must also appear in the user list with valid mapped accounts). After you create the UNIX group, you must map it to the existing NetWare group. If you do not create the corresponding UNIX group, the new group will not have access to the NetWare Print Services.

Note: When you import a group from another context, the group's complete NDS name appears in the user list relative to the default NDS context.

In addition to importing group objects from another context, you can also import an entire container, usually an organization (O) or organizational unit (OU). After you import the container, it appears as and is treated like any other valid group. This is useful if you want to associate an entire O or OU with a specific UNIX group.

The installation program also adds empty management groups to NDS. The installation program adds these groups strictly for the purpose of administration. You can add users to these management groups to grant them access to certain UNICON utility options. For detailed information about these groups, see “Authorizing UNICON Access” on page 112.

Information About NFS Users and Groups

All users who access NFS services must have accounts on the remote NFS system that correspond to their account on the local machine. If the NFS account is on a UNIX system, the information includes the following:

- ◆ UNIX username
- ◆ User identification number (UID)
- ◆ Home directory

- ◆ Preferred shell
- ◆ UNIX groupname
- ◆ Primary Group Identification Number (GID)

A typical UNIX system stores user account information in the `/etc/passwd` file and stores group information in the `/etc/group` file. You can copy this information directly to the NIS database on the NetWare server using the UNICON utility as described in “Transferring UNIX Configuration Files from Another Host” on page 99.

NFS Usernames, Groupnames, and ID Numbers

Each user uses a username to log in to the system. On NFS systems, the system assigns an identification number to the username. This number identifies file and directory ownership information. The user’s user identification number, or *UID*, can be a number between 0 and 65,535, with the numbers 0 through 99 usually reserved (0 is usually assigned to the Superuser). When the name of the NetWare user is mapped to an NFS account, the NetWare username is mapped to the NFS user’s UID.

NFS groupnames also have identification numbers. The range of numbers is between 0 and 65,535, with the numbers 0 through 99 reserved. The group identification number, or *GID*, identifies the user as a member of the primary group identified by that GID. The user’s NetWare groupname is mapped to the GID number for a UNIX group.

User Home Directories

The home directory is the absolute pathname of the user’s home directory on the NFS server. The NetWare Print Services server does not use this information, but displays it for information purposes. You can set the user’s home directory using the UNICON utility only if the remote NFS server uses the NetWare server as its NIS master.

User Preferred Shells

The shell information identifies the path of the shell program that runs when the NFS user logs in to the system. You can set the login account to run any program when a user logs in to the system, but the program typically creates an operating system working environment. The NetWare Print Services server does not use this information, but displays it for information purposes. You can set the user's preferred shell using the UNICON utility only if the remote NFS server uses the NetWare server as its NIS master.

Accessing a Service as a User or Member of a Group

When a user attempts to access one of the NetWare Print Services, the server first checks to see if the user has a valid mapped user account. If the user does not have a valid mapped user account, access is denied.

When a user attempts to access a remote printer using one of the NetWare Print Services, the local server sends the print request to the remote server where the print queue resides. If the user sending the print job does not have a mapped account on the NetWare or NFS server, the print job processes under the default user account, which you set during print service configuration. When a user attempts to access a remote file system, the requirements for access are more complex.

When a user attempts to access a remote file system using the NetWare Print Services, the local server sends the user's request to the remote server where the file resides. Before the user can access the file, the remote server checks to see that the user has the necessary permissions. To gain access, the user must have the necessary permissions and be recognized as one the following:

- ◆ The owner of the file.
- ◆ A member of the file owner's group.
- ◆ Any user able to log in to the server. (This category type is often referred to as "world" or "other" on NFS systems. The NetWare Print Services product uses the term WORLD.)

Before the user can belong to any one of these user types, the user must have an account on the system. Therefore, all users who need to access a remote file must have accounts on both the NetWare and NFS servers. These accounts must also be mapped together so that the servers know that the user on the NFS server is the same user on the NetWare server. The following sections describe creating user accounts, mapping users between NetWare and NFS accounts, and setting file access rights for users.

Creating NFS and NetWare User Accounts

Although established users probably already exist on both the NetWare Print Services server and the remote UNIX machine, you must still do the following:

- ◆ Create user accounts for the UNIX users on the NetWare Print Services server.
- ◆ Create user accounts for the NetWare users on the remote UNIX machine.

This process ensures that each user has a corresponding account on both systems.

You can transfer the configuration files from the remote UNIX machine to the NetWare server to add the UNIX users to the NetWare Print Services users list automatically, or you can add each UNIX user manually. You must also add each NetWare user to the remote UNIX machine.

Another alternative is to use the NetWare NIS server to manage your UNIX machines. This enables the UNIX machine to obtain the same user configuration information as the NetWare server.

Mapping User Accounts between NetWare and NFS

The last step in creating the user list consists of mapping each NetWare user account to the corresponding UNIX account. You map user accounts using the UNICON utility. The UNICON utility shows the NetWare user list and the UNIX user list in side-by-side columns. Mapped usernames appear on the same line (see Figure 1-5 on page 29). You can use the UNICON utility to create user accounts and map them together automatically as long as you use the same username for the NetWare user and the NFS user. You should use the automatic process when you have a long list of unmapped users; for example, after you transfer configuration files from another server.

You can also use the UNICON utility to map usernames manually. You should use this technique to map a single user or to map unlike usernames.

Figure 1-5
Mapping of User Accounts

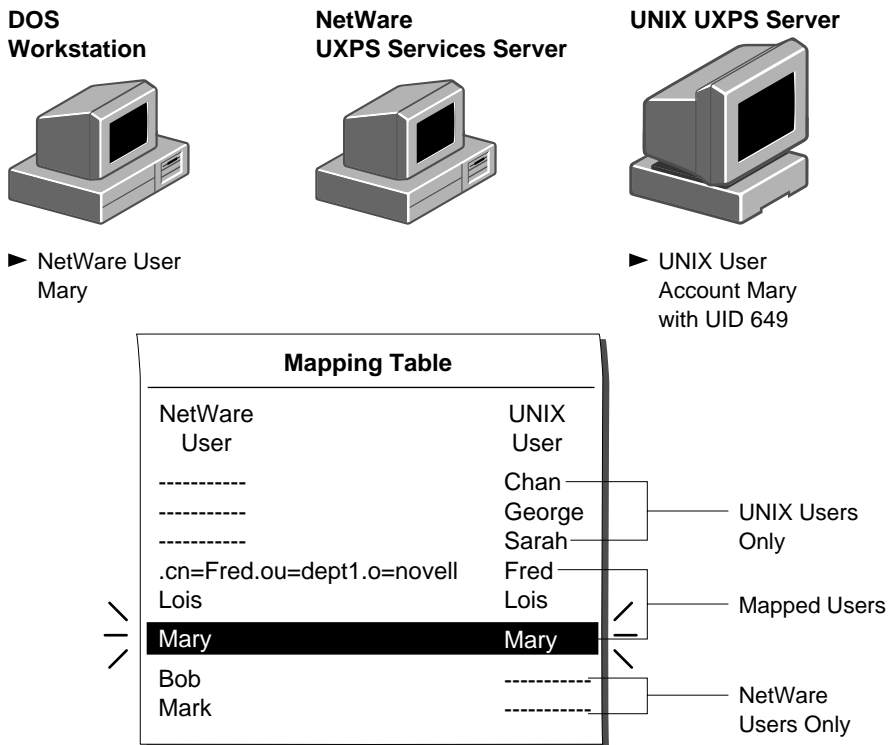

Mapping Groups between NetWare and NFS

The concept and process for mapping groups is the same as for users except that the group mapping process has a prerequisite. The prerequisite for mapping groups is that you complete the user mapping before you begin the group mapping. If you do not complete the user mapping before beginning the group mapping, the group membership is not complete.

Purpose of Server Object Mapping

To identify those UNIX users and groups on the system without a recognized account, the server maps these accounts to the server object. The server object maps to the NFS UID 0 (root). This allows the NetWare Print Server to identify nonmapped usernames and set special restrictions.

Purpose of -2 Mapping

To identify those NetWare users and groups on the system without a recognized account, the server maps these accounts to nobody (UID -2) and nogroup (GID -2). This allows the NFS Gateway to identify nonmapped usernames and set special restrictions.

Print Services

The NetWare® Print Services for UNIX* provides users with access to remote printers. The product provides the following print services:

- ◆ NetWare-to-UNIX
- ◆ UNIX-to-NetWare

This section provides an overview and a component-level description of the print services.

Print Services Overview

Print services enable users to access remote printers just as if they were local printers. After you install and configure the print services, users can print their work on remote printers without taking any special action. They use their operating system's standard commands and utilities. The print services transparently route the print job to the appropriate queue and printer.

Print Service Installation

The installation program installs the print services automatically. The UNICON utility enables you to configure and start the print services after installation. Although the installation program provides the option of starting any of the UXPS services at the end of the installation procedure, you cannot start the print services until configuration is complete.

Print Service Access

Users access print services based on user account, group membership, and host identification. Therefore, you must configure global objects as well as configuring the print services. Configuring global objects for print services consists of the following:

- ◆ Creating a host entry for each UNIX and NetWare host involved in printing
- ◆ Creating a user or group entry for each user and group that need access to the print services

Note: Both print services process print jobs sent by users and groups without mapped accounts by using the default user account as described in “Default UNIX User Account” on page 35 and “Default NetWare User Account” on page 42.

For more information on configuring global objects, see “Global Objects” on page 22.

NetWare-to-UNIX Print Service

The NetWare-to-UNIX print service takes print jobs from NetWare print queues and sends them to remote computers. After a print job reaches a remote print queue, the remote computer sends the print job to the appropriate printer. Figure 1-6 on page 33 shows how print jobs flow from a NetWare print queue to a remote computer’s print queue.

Figure 1-6
NetWare-to-UNIX Printing Process

The user issues a print command to print the file **README.TXT** to the NetWare queue named **NW2UNIX**.

The print command deposits the job in the **NW2UNIX** print queue, which is configured to service the UNIX NDS printer object.

The NetWare UXPS print server removes **README.TXT** from the queue and hands it to the NetWare-to-UNIX Print Gateway.

The NetWare-to-UNIX Print Gateway establishes a TCP/IP connection with MADRID's LPD server whose IP address is listed in the host list, and transmits **README.TXT** to MADRID's LPD daemon.

If the printer is busy when MADRID's LPD daemon receives **README.TXT**, the daemon temporarily stores the job in the **/usr/spool/sparky** spool directory, as specified in the **/etc/printcap** file.

When the printer becomes available, MADRID'S LPD server sends **README.TXT** to the printer **sparky**.

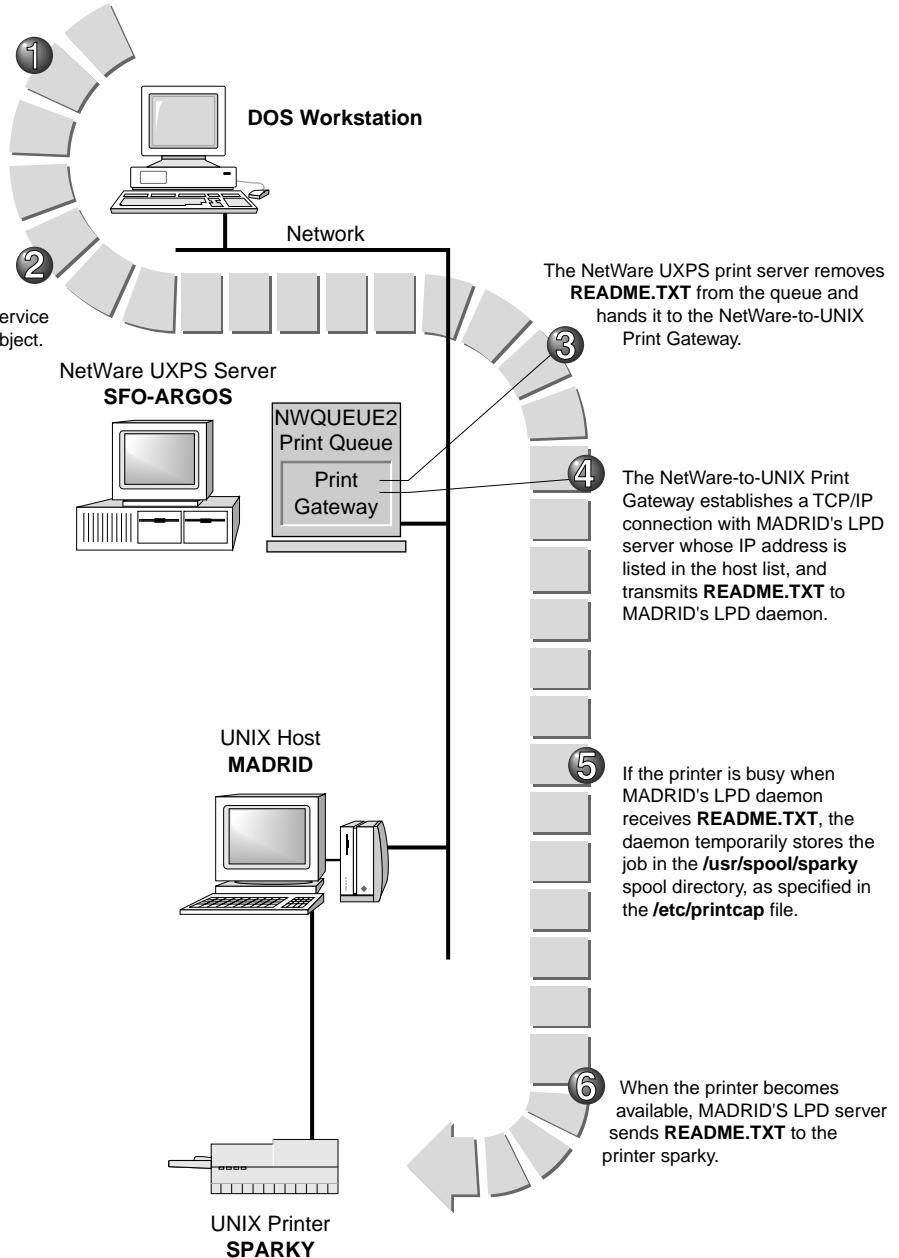

NetWare-to-UNIX Print Service Management Using the UNICON Utility

The UNICON utility enables you to manage all aspects of the NetWare-to-UNIX print service. The UNICON utility also enables you to view and modify NDS™ objects you create using other NetWare 4 print utilities such as PCONSOLE and PRINTCON. These utilities are not provided with NetWare 5. You will have to use the NetWare Administrator utility for this purpose.

NetWare-to-UNIX Print Service Components

The NetWare-to-UNIX print service consists of the following components:

- ◆ Default print server
- ◆ UNIX printer objects
- ◆ Default UNIX user account (optional)
- ◆ UNIX host

The following sections provide information about the NetWare-to-UNIX print service components, which you should understand before you configure the print service.

Default Print Server

The print server takes jobs from the print queue and passes them to the NetWare-to-UNIX print gateway. The print gateway then sends the print job to the remote UNIX host.

You must select a default print server before configuring any of the other NetWare-to-UNIX print components. The print server can exist in the same OU as the NetWare server running the NetWare-to-UNIX print service, or it can exist in another location in the NDS tree.

UNIX Printer Objects

UNIX printer objects represent remote UNIX printers. There must be an NDS printer object for each remote UNIX printer that accepts print jobs from the NetWare-to-UNIX print service.

Creating a new UNIX NDS printer object consists of identifying the following:

- ◆ Which UNIX host is attached to the printer
- ◆ Which NetWare queues can send print jobs to the UNIX printer

Once the NDS UNIX printer object exists, NetWare users can select the UNIX printer just as they would select any other NDS printer.

Default UNIX User Account

The default UNIX user account enables NetWare users who are not listed in the OU or who do not have mapped UNIX accounts to access UNIX printers. When a user sends a print job to the UNIX printer, the print service checks to see whether the user has a valid mapped user account. When a user does not have a valid mapped user account, the print service submits the print job under the default UNIX user account. Many administrators select an account such as GUEST as the default UNIX user account.

The NetWare-to-UNIX print service also includes an option that specifies using the default user account for all users who use the print service. By selecting this option, you can avoid having to create a mapped account for every user who wants to use the print service.

UNIX Host Configuration

Each UNIX printer associated with an NDS printer object attaches to a UNIX host. Each UNIX host requires a method for receiving and processing a print job, information about the NetWare queue sending the print job, and a place to store the print job before sending it to the printer. To meet all of these requirements, each UNIX host must be set up as follows:

- ◆ Line Printer Daemon (LPD)

The UNIX host uses the LPD protocol to receive print commands and print jobs from the NetWare server. Therefore, each UNIX host that receives print jobs from the NetWare-to-UNIX print service must support and run the lpd daemon.

- ◆ **printcap file**

Most UNIX operating systems use a printcap file to control local and remote printing. Each entry in the printcap file specifies a printer, the queues associated with the printer, and some additional configuration parameters. Each printer to which the host sends print jobs must have an entry in the printcap file.

If you use a currently configured UNIX printer, it probably already has an entry in the printcap file. However, you may want to create an additional printcap entry that specifies a different spool directory for incoming NetWare print jobs.

- ◆ **Spool directory**

The UNIX host temporarily stores the print jobs it receives from the NetWare server in the print spool directory specified in the printcap entry. If you use a currently configured UNIX printer, there is probably already a printcap entry that specifies a spool directory. If you create a printcap entry that specifies a new spool directory, you must create the spool directory manually.

The Managing section provides step-by-step instructions for setting up a UNIX printer host.

UNIX-to-NetWare Print Service

The UNIX-to-NetWare print service accepts print jobs from remote computers and places them into NetWare print queues. After a job reaches a NetWare print queue, NetWare sends the job to the appropriate printer. Figure 1-7 on page 37 shows how print jobs flow from a remote computer's print queue to a NetWare print queue.

Although this product refers to the print service as the UNIX-to-NetWare print service, the service is accessible to any remote computer that supports the LPD protocol. If your remote computers do not support the LPD protocol, these computers may still be able to access the print service using the rsh command. For more information on using the rsh command, see "Using the rsh Command" on page 207.

Figure 1-7 UNIX-to-NetWare Printing Process

The UNIX user issues the `lpr` command to print the file `report.txt` to the NetWare printer. The `/etc/printcap` file contains an entry for this printer that points to the exported NetWare queue `UNIX2NW` with a local spool directory `/usr/spool/unix2nw`.

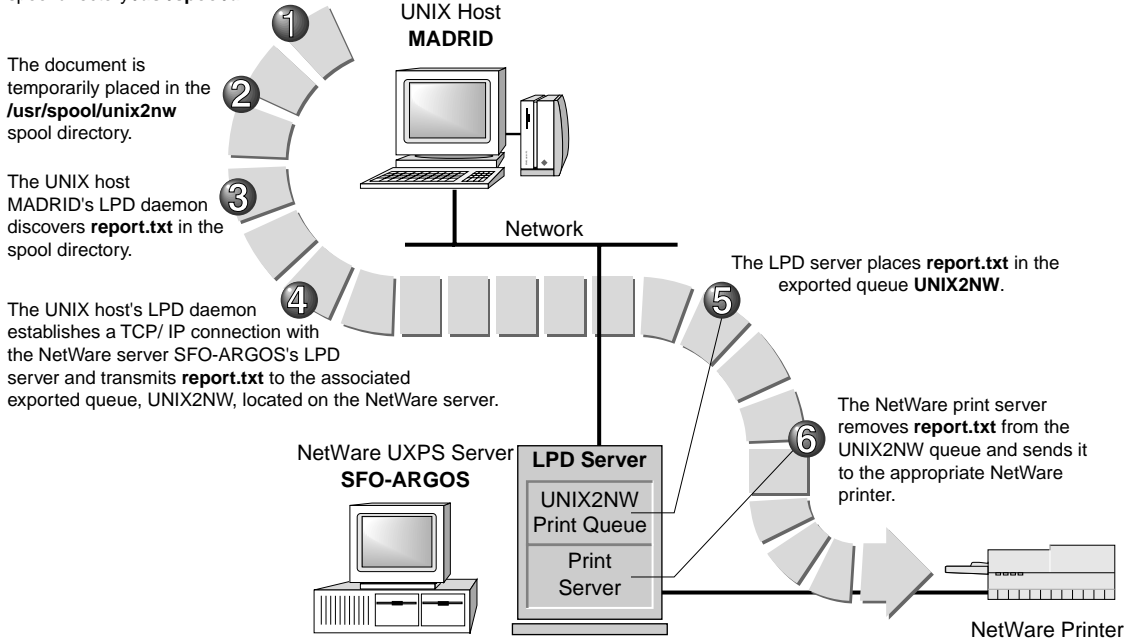

UNIX-to-NetWare Print Service Management

The UNICON utility enables you to manage all aspects of the UNIX-to-NetWare print service. The UNICON utility also enables you to view and modify NDS objects you create using other NetWare 4 print utilities such as PCONSOLE and PRINTCON. These utilities are not provided with NetWare 5. You will have to use the NetWare Administrator utility for this purpose.

UNIX-to-NetWare Print Service Components

The UNIX-to-NetWare print service consists of the following components:

- ◆ Exported NetWare queues
- ◆ Print job configurations (optional)
- ◆ Default NetWare user account (optional)
- ◆ Default exported queue configuration (optional)
- ◆ UNIX host

The following sections provide information about the UNIX-to-NetWare print service components, which you should understand before you configure the print service.

Exported NetWare Queues

Before a UNIX user can access a NetWare printer, the NetWare queue associated with the printer must be made available to accept UNIX print jobs from UNIX hosts. This process is called *exporting* the NetWare queue. Exporting a NetWare queue consists of the following:

- ◆ Identifying which UNIX hosts can access the exported queue
You can allow access to all hosts or to specific trusted hosts or hostgroups.
- ◆ Selecting a filter type
You can select a filter type of None, Line Printer, or Postscript.
- ◆ Selecting a print job configuration
The print service applies the specified print job configuration to all print jobs it receives from UNIX hosts. For information on print job configurations, see “Print Job Configuration Entries” on page 41.

Remote Exported NetWare Queues

The UNIX-to-NetWare print service also enables UNIX users to send print jobs to remote print queues on both NetWare 3.x and NetWare 4 / NetWare 5 servers, as shown in Figure 1-8 on page 39. You can export remote print queues from

- ◆ A NetWare 4 / NetWare 5 server in the same NDS tree
- ◆ A NetWare 3.x server or a NetWare 4 / NetWare 5 server in a different NDS tree

Figure 1-8
Printing to a Remote Queue

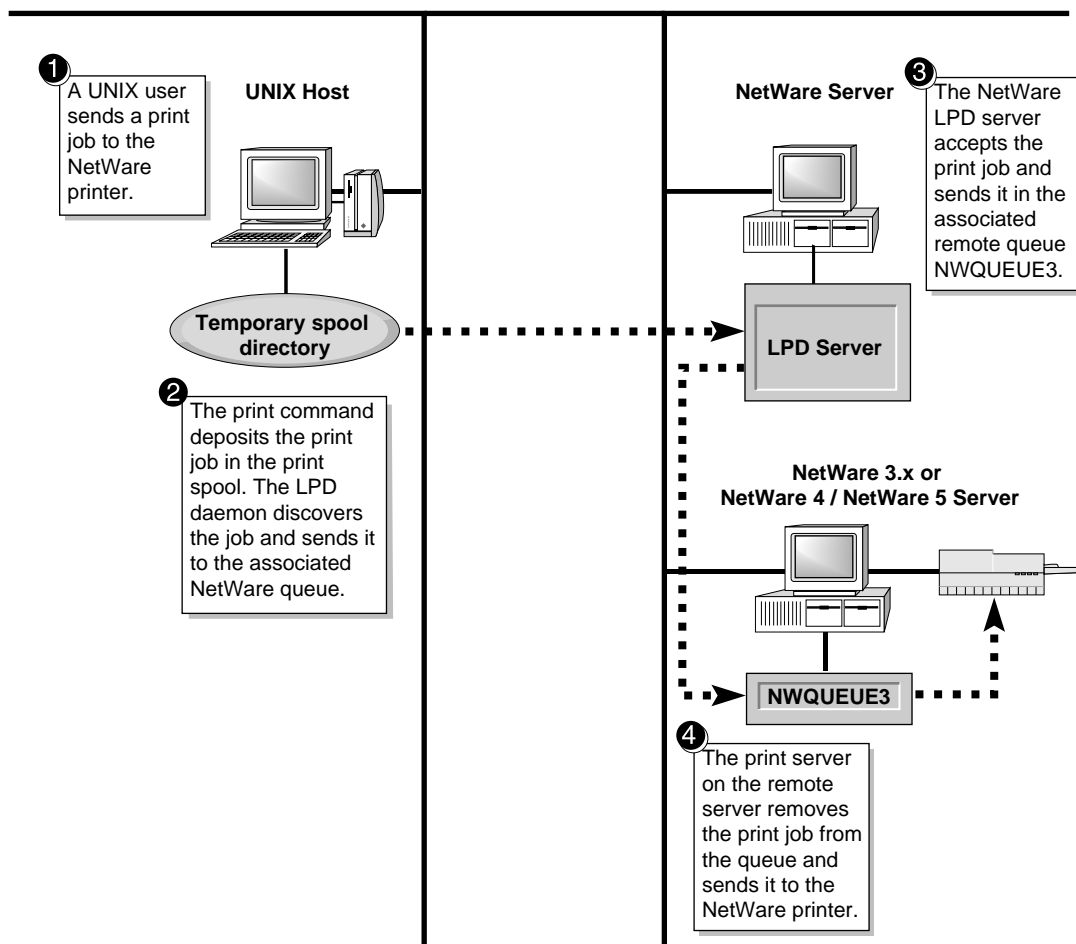

Exporting Queues from a NetWare Server in the Same NDS Tree

The UNIX-to-NetWare print service enables UNIX users to submit print jobs to a remote queue located on a NetWare server in the same NDS tree as the server running the print service. Using the object browser, you can select the remote queue from any location within the NDS tree. After selecting the remote queue, you export it as you would any other local queue.

When the print service receives a print job from a UNIX host, it submits the print job to the remote NetWare queue as the user named IP Service Handler. Therefore, the print service requires you to make IP Service Handler a queue user of the remote print queue using the PCONSOLE or NetWare Administrator utility.

Exporting Queues from a NetWare 3.x Server or a NetWare 4 / Netware 5 Server in a Different NDS Tree

The UNIX-to-NetWare print service enables UNIX users to submit print jobs to a queue located on a NetWare 3.x server or a NetWare 4 / NetWare 5 server in a different NDS tree. Configuring this type of remote queue consists of the following:

- ◆ Specifying a default username for logging in to the remote server

The UNIX-to-NetWare print service cannot submit print jobs to the remote print queue if the remote user account has a password. Therefore, the appropriate entry in the /ETC/NWPARAMS file must specify a valid bindery user with no password. The remote user must also be a queue user of the remote print queue.

- ◆ Creating a local NDS print queue that is linked to the remote print queue

The object browser can access only the print queues in the NDS tree where the server running the service resides. Therefore, the print service enables you to create a new queue and link it to a remote queue.

- ◆ Exporting the local queue that corresponds to the remote queue

The UNICON utility enables you to export the local queue that corresponds to the remote queue. When the print service receives a print job within the local queue, it forwards the job to the remote queue automatically.

For step-by-step instructions on printing to remote queues, see “Printing to Remote Print Queues” on page 202.

Print Job Configuration Entries

A print job configuration entry consists of a group of characteristics that define how the print service prints a print job. The print service applies the default print job configuration entry assigned to an exported NetWare print queue to all print jobs the queue receives from remote computers. The UNICON utility enables you to select an existing print configuration entry or create a new entry.

A user can override the default print job configuration assigned to an exported NetWare queue by specifying a different configuration in the `lpr` command line. The print service applies print job configuration entries in the following order of precedence.

1. Print job configuration entries specified on the `lpr` command line (for example, `lpr -J /printcon_name`).
2. Print job configuration entries associated with the exported queue through the UNICON utility.
3. The default print job configuration entry for the NetWare user account mapped to the remote user account.
4. The default print job configuration entry for the NDS OU where the mapped NetWare user account resides.

Note: Default print job configuration entries are set from a workstation using the PRINTCON or NetWare Administrator utility.

Default NetWare User Account

The default NetWare user account enables UNIX users who do not have mapped NetWare accounts to access NetWare printers. When a user sends a print job to the NetWare printer, the print service checks to see whether the user has a valid mapped user account. When a valid mapped user account does not exist for the user, the print service submits the print job under the default NetWare user account. Many administrators select an account such as GUEST as the default NetWare user account.

The UNIX-to-NetWare print service also includes an option that specifies using the default user account for all users who use the print service. By selecting this option, you can avoid having to create a mapped account for every user who wants to use the print service.

Default Exported Queue Configuration

The default exported queue configuration specifies default configuration values for exported NetWare queues. The UNICON utility uses these values when exporting a NetWare queue for access by UNIX print jobs. After exporting the NetWare queue, you can change the default values for the queue as needed.

NetWare Print Spool Directory

The UNIX-to-NetWare print service uses the print spool directory as a temporary storage area for incoming print jobs before sending the jobs to the appropriate print queue.

By default, the print service creates the print spool directory on the SYS: volume. However, the directory can reside on another volume if necessary.

UNIX Host Configuration

Each UNIX host that sends print jobs to a NetWare queue requires a method for transmitting a print job, information about the NetWare queue receiving the print job, and a place to store the print job before sending it to the NetWare server. To meet all of these requirements, each UNIX host must be set up as follows:

- ◆ Line Printer Daemon (LPD)

The UNIX host uses the LPD protocol to transmit print commands and print jobs to the NetWare server. Therefore, each UNIX host that sends print jobs to an exported NetWare queue must support and run the lpd daemon.

- ◆ printcap file

Most UNIX operating systems use a printcap file to control local and remote printing. Each entry in the printcap file specifies a printer, the queues associated with the printer, and some additional configuration parameters. A printcap entry must exist for each printer to which the UNIX host sends print jobs.

Before the UNIX host can send print jobs to a NetWare printer, you must create a printcap entry that associates a printer name with the exported NetWare queue.

- ◆ Spool directory

The UNIX host temporarily stores print jobs in the print spool directory before sending them the NetWare server. If the lpd daemon is already running, there is probably already a spool directory. If you create a printcap entry that specifies a different spool directory, you must create the new directory manually.

The “Managing” on page 111 section provides step-by-step instructions for setting up a UNIX printer host.

FTP File Transfer Service

The NetWare® FTP server program enables FTP users to access and transfer NetWare files. Before an FTP client can access files using the NetWare FTP service, the client must be running an FTP client program.

Using NetWare's FTP service, users can use the ftp command from a workstation with FTP access to log in to the NDS™ tree. Using the FTP server as a connector, users can also “ftp” to a remote NetWare server (including 3.x) that is not running the FTP service.

The FTP server process is based on the standard ARPANET File Transfer Protocol that runs on top of TCP/IP. The NetWare FTP implementation conforms to RFC-959.

This section provides an overview of the NetWare FTP service and conventions.

FTP Service Startup

The installation program installs the FTP service automatically. After the installation program installs the FTP service, you must start it. You can start the service at the end of installation or after installation, using the UNICON utility. The FTP service then starts automatically each time it receives an FTP client login. This allows the FTP service to remain unloaded until there is an active FTP session. By using this approach, the NetWare server saves memory and other resources by unloading the FTP service when it is not in use. The amount of time the FTP server remains loaded with no connections is configurable.

Note: The FTP service cannot load from the console.

FTP Service Configuration

When the FTP service starts, its configuration is based on the FTP parameters set within the UNICON utility. The FTP parameters enable you to specify session limitations, activate security options, and set logging levels. If the configuration remains unchanged, the FTP service software uses the default values. For a detailed description of the FTP parameters along with the default values, see “FTP Server Parameters Form” on page 264.

NetWare NDS Access Through FTP

This section describes how users can use FTP to access the NetWare NDS™ tree and then how they can access remote NetWare servers.

Note: The FTP service tracks and records all FTP access in the FTP log file. For more information on the log file, “FTP Log File” on page 57.

Default Server Access

Users can log in to the NetWare FTP server from a workstation running FTP client software using the following command:

```
ftp SERVER_NAME
```

Users replace *SERVER_NAME* with the hostname of the NetWare server running the FTP service.

The FTP server then prompts the user for a username and password if required.

After the user logs in, the FTP server places the user in to the user’s NDS home directory (if defined) and attaches to the server where the home directory resides. If the NDS home directory is not defined, the FTP server places the user in to the user’s home directory on the NetWare server running the FTP service. If the FTP server cannot locate a home directory for the user, the user is placed in to the FTP default user directory defined by the FTP server parameters.

As with any NDS™ login, the server must assign an NDS context to each user that logs in to the FTP server. After determining the user’s home directory, the FTP server sets the default context to the same context as the server where the home directory resides. Users maintain the default context throughout the FTP session, unless they choose to change it. Users can change their default context using the FTP SITE CX command. Changing the default context determines whether a user must use a relative or complete NDS username when logging in to additional NetWare servers through the server running the FTP service.

Remote Server Access Through the FTP Server

After logging in to the NDS tree, users can access files and directories on a remote NetWare server that is not running either the FTP service or TCP/IP, as illustrated in Figure 1-9 on page 47. When accessing remote files, the user is known as the same user object that logged in to the home server.

After logging in to the server running the FTP service, users must use the following format to represent files and directories on the remote server:

```
//remote_server_name/volume/directory_pathname
```

The double slash (//) indicates that the user wants to access a remote server. The name of the remote server must be the first entry after the double slash. Users must enter *volume* and *directory_pathname* in UNIX* format, as in the following example:

```
//joe-server/sys/public
```

After logging in to the FTP server, users can use the FTP SITE SERVER command to display the available NetWare servers under the current NDS context. Users can also use the FTP SITE SLIST command to display all available NetWare servers, including bindery servers.

When a user accesses a directory on a remote server, the NDS context for that user changes if the remote server is in a different NDS location. If the user accesses a NetWare 3.x or earlier server, the user's context is set to the bindery context. If the user accesses a NetWare 4 / NetWare 5 server, the user's context is set to the default context of the remote server.

If users do not want their context changed when accessing remote servers, they can explicitly set their context using the FTP SITE CX command.

Using the FTP service to access remote servers imposes the following limitations:

- ◆ Does not grant remote access to anonymous users.
- ◆ Does not allow users to rename files and move them between servers.

- ◆ Supports the DOS namespace only.
- ◆ Does not support the use of the slash(/) for root and tilde(~) for login directory. For example, if a user changes to a remote server and then enters the command `cd /`, the user switches to the root directory on the home server, not the remote server.
- ◆ Does not support the bindery user Supervisor unless the bindery context is set on the server. This is true for all servers. The supervisor account password initially sets to the ADMIN password when you place the server into the NDS tree, but the password is not maintained if the ADMIN password changes. To change between servers as Supervisor, the passwords must remain the same.

Figure 1-9
Accessing a Remote Server Using the FTP Service

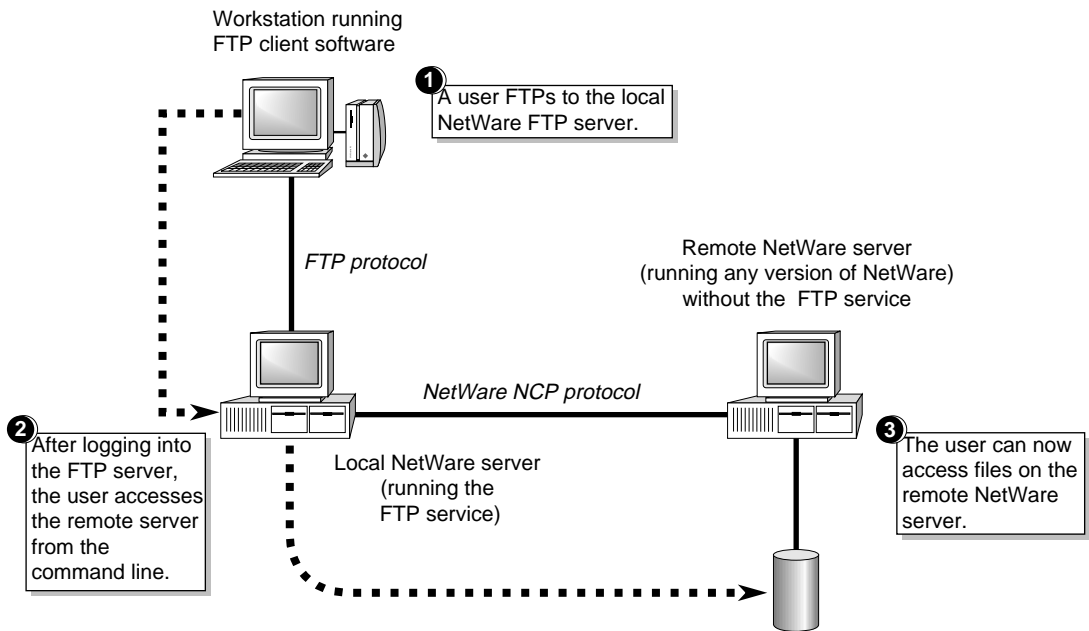

Remote Server Access to Another NDS Tree through the FTP Server

The following restrictions apply when accessing a remote server that is not in the NDS tree:

- ◆ NetWare NDS servers must have bindery services set up, and the user must exist by the same name and password.
- ◆ For NetWare non-NDS servers, the user must exist by the same name and have the same password.

Remote Server Logins

Users can log in directly to remote NetWare servers. This allows a user to log in as a user that does not exist in the NDS tree or have the same password. Users must use the following syntax for the username when logging in directly to a remote NetWare Server:

```
remote_server_name/username
```

Users do not need to use a double slash for a remote login. The FTP service determines the NDS context for login relative to the remote server, unless the user has set the context explicitly.

FTP Server Access through LAN WorkPlace Products

The Rapid Filer™ utility (MS* Windows-based FTP client) in LAN WorkPlace® products does not provide a way to change which name space the NetWare FTP server uses. Therefore, Rapid Filer users always use the preconfigured name spaces. Novell suggests that users always select UNIX as the remote operating system when using Rapid Filer to access the NetWare FTP server. Setting the remote operating system to DOS does not change the current name space.

FTP Conventions

The FTP service uses a specific set of conventions. The following sections describe these conventions and provide examples of how an FTP user should use them when accessing files through FTP.

Directory Access Using Pathnames

FTP users see complete pathnames in UNIX-like format regardless of the volume or the name spaces the volume supports. For example, users must construct a pathname as follows:

/volume/pathname

The FTP service can process absolute pathnames of up to 255 characters.

FTP supports UNIX special characters in filenames, known as wildcard characters (such as * and ?), with the following restrictions:

- ◆ The FTP service supports the UNIX method of using a substitute name containing special characters to refer to a group of files with similar names (*globbing*). For example, the two files AUTO1.TXT and AUTO2.TXT can both be represented by the single substitute filename AUTO?.TXT by using the special character “?” to stand for any one character. This support is limited to FTP commands that list directories and files.
- ◆ The FTP server supports the tilde (~) character as used in UNIX. The tilde character expands into the pathname of the user’s home directory.
- ◆ The FTP service supports using two periods (..) to reference the parent directory; for example, the command “cd..” makes the directory above the current directory the new current directory.
- ◆ FTP supports the root (/) directory as a virtual directory. Users on client machines can move (cd) to this directory and view all of the mounted volumes (using the ls or dir command), but cannot transfer files from this directory. Also, users cannot log in to the root directory by default.

Directory Access Using Directory Maps

The FTP service supports the use of NDS directory maps to access directories anywhere in the NDS tree. NDS directory maps are executed based on the FTP user's NDS context. FTP users can display available directory maps using the FTP SITE PATH command. This command displays the name of the maps, along with a corresponding description if available. This enables users to access files and directories without having to know where they reside. The directory map must be the first portion of the filename within the FTP command.

For more information on directory maps, refer to the NetWare 5 documentation.

Name Space and Filenames

The FTP service uses both the DOS and NFS name spaces on the FTP server but supports only the DOS name space on remote servers. Regardless of the name space, users view the response to the ls command (FTP NLIST command) or dir command (FTP LIST command) in the UNIX format.

The UNICON utility enables you to set the default configured name space. After setting the default name space, FTP users can change it using the QUOTE SITE DOS command or the QUOTE SITE NFS command.

If the FTP service configuration specifies the NFS name space, file operations on volumes that do not support the NFS name space take place in the DOS name space. Files and directories that users create on volumes that do not support the NFS name space must use the restricted DOS file naming conventions, such as no more than eight characters for the name plus no more than three additional characters for the suffix following the period.

The server displays the response to a dir command in the following format for DOS name space:

```
<type> <rights> <owner> <size> <time> <name>
```

The system replaces the variables as follows:

type—the type of file, where *-* indicates a file and *d* indicates a directory.

rights— the effective NetWare rights of the user to this file or directory.

owner—the NetWare user who created this file or directory.

size—the size, in bytes, of the file or directory.

time—the date and time the file or directory was last modified.

name—the name of the file or directory in the current name space.

The server displays a response to a *dir* command in the following format for NFS name space:

<type> <rights> <#links> <owner> <group> <size> <time> <name>

The system replaces the variables as follows:

type—the type of file, where *-* indicates a file and *d* indicates a directory.

rights— the NFS permissions of the user to this file or directory.

of links—number of file links to the file.

owner—the NFS user who created this file or directory.

group—the associated NFS group with rights to this file or directory.

size—the size, in bytes, of the file or directory.

time—the date and time the file or directory was last modified.

name—the name of the file or directory in the current name space.

The following examples show how FTP processes filenames in the NFS and DOS name spaces. The first example is a response to the dir command using the NFS name space. Note the file named 123456789.123456, which is truncated in the second (DOS) example:

```
-rw----- 2 root wheel    512  Oct 14, 99 8:45 pm
deleted.sav
-rw----- 1 root wheel    3166 Oct 14, 99 9:45 pm
  vol$log.err
-rw----- 1 bill support 1285 Oct 14, 99 9:55 pm
  123456789.123456
drw----- 2 mary support  512  Oct 14, 99 7:33 pm
  locktst
drwxr-xr-x 2 root wheel    512  Oct 14, 99 4:33 pm brief
```

Second example:

```
-[RWCEAFMS] server1          3166    Sept 14, 99 2:30
pm vol$log.err
-[RWCEAFMS] bill            1285    Sept 14, 99 3:39
  pm 1234567.123
d[RWCEAFMS] supervisor      512     Sept 14, 99 4:20
  pm deleted.sav
d[RWCEAFMS] mary            512     Sept 14, 99 8:50
  pm locktst
d[RWCEAFMS] root            512     Sept 14, 99 8:55
  pm brief
```

Name Space and File Links

The FTP server fully supports file and directory modification using hard links and symbolic links. Therefore, the FTP service also supports file linking when the current name space is NFS.

Links in the NFS Name Space

The following directory listing (created using the FTP LIST command) shows examples of file links:

```
-rw----- 1 root wheel  349  Oct 20, 99 10:39 pm file
-rw----- 2 root wheel  349  Oct 21, 99 12:45 pm
  hardlink
-rw----- 1 bill support  4    Oct 21, 99 12:45 pm
  symlink -> file
drw----- 1 mary support  3    Oct 21, 99 12:45 pm
  symdir -> dir
drw----- 2 mary support 512  Oct 20, 99 10:31 am dir
drwxr-xr-x 3 root wheel  512  Oct 21, 99 12:45 am
  harddir
```

This example shows an original file and a directory with both hard links and symbolic links. The file named file is a regular file with the hard link named hardlink linked to it. The name dir identifies a regular directory with the hardlink harddir pointing to it. The name symlink identifies a symbolic link to the file named file, and symdir is a symbolic link to the directory named dir.

The symbol -> means “pointed to.” The name before it is the symbolic link, and the name after it is the regular file or directory. The letter “l” in the first field indicates that the entry is a symbolic link.

A symbolic link consists of the name of the file or directory to which the link points and its file size is the name length of the pointed-to file or directory name. In the above example, symdir points to dir, which has a 3-byte name length.

The DELE command removes a hard link to a file. However, you cannot delete a hard link to a directory unless you use the appropriate operating system command. The DELE command also removes symbolic links.

When users use FTP commands such as RETR and STOR, the link is traced and operations are performed on the pointed-to entry. For example, RETR symlink retrieves the contents of the file named file.

The FTP command CWD changes the current directory to the pointed-to directory. For example, after a user uses CWD to change to symdir created above, a PWD command shows dir. This applies to both symbolic and hard links.

Links in the DOS Name Space

Hard links are invisible in the DOS name space. Also, the DOS name space does not support symbolic links. An equivalent directory listing from DOS for the above example shows the following:

```
-[RWCEAFMS] supervisor 349 Oct 20, 99 10:31 pm file
-[RWCEAFMS] supervisor 3 Oct 21, 99 12:45 pm symdir
-[RWCEAFMS] supervisor 4 Oct 21, 99 12:45 pm
  symlink
d[RWCEAFMS] supervisor 512 Oct 20, 99 10:31 pm dir
```

Note that the listing does not show hard links, and because the name space does not support symbolic links, the listing displays them as regular files. The l symbol used to identify symbolic links in the NFS name space is replaced by - and the symbol -> does not appear. This means that the DOS name space treats a symbolic link as a regular file. Therefore, RETR symlink retrieves the 4-byte name content named file, instead of the content of the file named file.

Name Space and Text Files

Transferring some ASCII files to or from the FTP server may sometimes result in translation of data.

NFS and DOS handle text files in slightly different ways. NFS applies a line feed (LF) as the line terminator in text files. DOS uses a carriage return and a line feed (CRLF).

When a user transfers ASCII files, the FTP protocol requires each line of the file to be terminated by a CRLF. Therefore, when FTP sends an existing file from the NetWare NFS name space, it replaces line feeds with CRLFs in the outgoing data. Files in the DOS name space already have the carriage return, so FTP sends them unaltered.

The FTP service stores incoming files in the text format applicable to the volume's current name space. If the file is put in the NFS name space, the FTP service stores it with line feeds as line terminators. If the file is put in the DOS name space, the FTP service stores it with a carriage return and a line feed at the end of each line.

To prevent translation, users can set the FTP connection to BINARY.

SITE and STAT Commands

The NetWare FTP server also supports two site-specific commands:

- ◆ STAT inquires about the status of the current connection or the status of a file or directory.
- ◆ SITE provides special file transfer services specific to your system.

For a detailed description of the two commands, including syntax, see "Using the STAT and SITE Commands" on page 279.

Note: These commands are unique to the NetWare FTP service and are not standard FTP commands.

FTP Security Considerations

The FTP service provides the following security options:

- ◆ Limiting guest account access
- ◆ Restricting FTP access
- ◆ Monitoring FTP access

The FTP service utilizes grace logins to protect further against unauthorized access.

Guest Accounts

The FTP service enables you to create an account for general FTP use. This NetWare user account is named ANONYMOUS. FTP users can enter the ANONYMOUS user account name when the FTP server prompts for a username. Users can then enter any password because the FTP service does not validate the password; however, the user must enter a password before the FTP service permits access.

The FTP service specifies the login directory for the guest user as the Anonymous User's Home Directory parameter. By default, the login directory is /sys (the entry in UNIX format equivalent to NetWare volume SYS:); however, the UNICON utility enables you to change the login directory.

A user who logs in to a directory can also access subdirectories. If security is a concern, it is better to specify an isolated subdirectory as the login directory.

Grace Logins

If a user with an expired NetWare password attempts to log in to the FTP server, a message stating that the password has expired is returned after the user logs in. Logging in with an expired password uses a grace login. If all of a user's grace logins expire, the user cannot log in and receives an error message.

Restrict FTP Access File

The FTP service enables you to limit FTP access to a user, a client host, and the IP address of a client host. You limit access by editing the RESTRICT.FTP file using the UNICON utility.

Important: If the RESTRICT.FTP file is empty or does not exist, the FTP service does not allow any FTP access.

The RESTRICT.FTP file uses keywords in the following format to specify types of access:

```
username  
[ ACCESS=GUEST | READONLY | NOREMOTE , DENY , NORMAL ]  
  [ ADDRESS=hostname , IP_Address , * ]
```

where:

username specifies the NetWare user account.

ACCESS designates how the user can access the file system.

ADDRESS specifies the client address from which login is attempted. The address can be a hostname or an IP address.

For a detailed description of how to set up the RESTRICT.FTP file, see “Restricting Access to FTP” on page 267.

FTP Access Logs

The FTP service provides two ways to monitor FTP usage:

- ◆ The FTP log file, which maintains an activity record of FTP sessions.
- ◆ The intruder log file, which maintains a record of failed login attempts.

Both of these files can identify potential security problems.

FTP Log File

The UNICON utility enables you to view the FTP log file. The FTP log file provides information on FTP logins and activity, depending on the reporting level you select. The FTP service records information for each successful login.

Intruder Log File

The UNICON utility also enables you to view the intruder log file, which provides information about unsuccessful login attempts. The intruder log provides the following information:

- ◆ Address of the machine where the login originated
- ◆ The time of attempted access
- ◆ Login name of the user
- ◆ Incorrect password

Using this information, you can determine which machine the unauthorized user is using. You can also determine the number of times a specific unauthorized user has attempted to access the system.

chapter **2** *Planning*

Planning is an important step and should be completed prior to installing and configuring this product. Prepare for installation and configuration by completing the planning worksheets.

Using the Planning Worksheet

Complete the “Planning Worksheets” on page 76 before beginning installation. You might not need to fill in every worksheet, but to ensure a smooth installation and configuration, it is recommended that you fill in all that apply.

After completing the worksheets, you will have all the information you need to install and configure your NetWare Print Services for UNIX server. The completed worksheets are also a valuable written record of your configuration.

For examples of completed planning worksheets, see “Planning Worksheets” on page 76. The worksheet entries are also defined in that section.

Note: These worksheets are examples only. You must fill in the applicable worksheet(s) with the information that applies to your specific network configuration.

Understanding the Sample Planning Information

The sample worksheets in this section use hypothetical information from a company called Argos. Each worksheet is explained using the Argos company as an example.

The sample configuration is a network with one NetWare® Print Services for UNIX server, a Novell DOS client (represented by one PC), and a UNIX host. The UNIX host also serves as a print server.

Sample Network Configuration

Figure 2-1 on page 61 illustrates a simple configuration used by the Argos company. The Argos company has a small publications group. This group has documentation files to which people in the Marketing group need access. The Marketing group, in domain Marketingnet, can access these files using the NetWare Print services for UNIX server running on the NetWare server SFO-ARGOS, which is in the Pubsnet domain.

To provide documentation for the marketing group, a user at the DOS workstation can use the Netware-to-UNIX Print Services to send jobs to the UNIX printer called Sparky. A UNIX user in the marketing group can send jobs to the NetWare printer attached to the NetWare server SFO-ARGOS. This is accomplished using the UNIX-to-NetWare Print Services.

The NetWare server SFO-ARGOS is running as an NIS and DNS master.

Figure 2-1
Sample Configuration

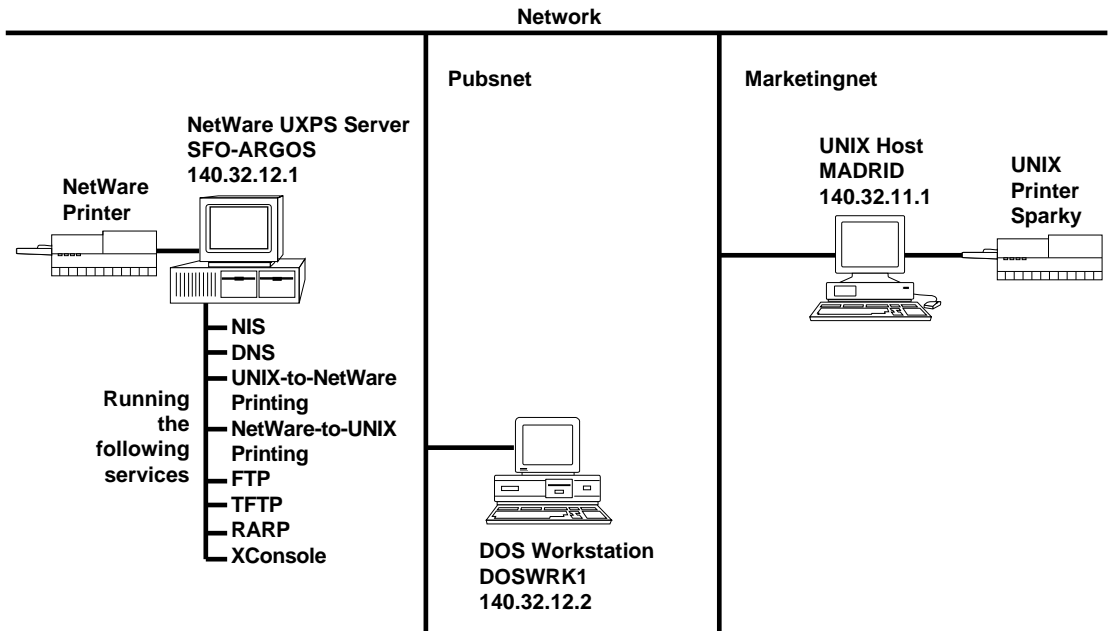

Installation Worksheet

Section 1 of the Installation Worksheet lists the prerequisites your system must meet before you can install the NetWare Print Services software. For more information on the prerequisites listed in this portion of this worksheet, see “Meeting the Installation Prerequisites” on page 90.

Section 2 lists installation information for the server. This section also contains information about configuring DNS and NIS.

The NetWare Print Services server can be set up as the NIS and DNS master name server, or it can obtain information from an existing NIS or DNS master name server.

If the NetWare Print Services server is the DNS master name server, it can optionally be configured to master selected subnets in the form of in-addr.arpa domains (if the network supports subnetworks). This is in addition to mastering the DNS domain.

There are two choices on the Available Name Services Options menu:

- ◆ Local NIS and DNS
- ◆ Remote NIS and DNS

Local NIS and DNS—Allows you to update and manage the NIS master database using UNICON. Once you configure a NetWare server as the master, it can provide information to any additional NFS/NetWare Print Services servers. The DNS database should be managed using the client based DNS/DHCP utility.

Remote NIS and DNS—Does not allow you to update or manage the NIS database using UNICON, unless the remote services run on a NetWare server. UNICON displays the user, group, and host information stored on the master, but does not allow modification. You must manage all user, group, and host information on the master. The DNS database should be managed using the client based DNS/DHCP utility.

See “Information Worksheet Example” on page 62 for a sample of how to use this worksheet.

Information Worksheet Example

The Argos company has chosen to install the NetWare NIS and DNS databases on the server on which the NetWare Print Services software is being installed (SFO_ARGOS). Therefore, the NetWare server IP address is also the NIS and DNS master server’s address. This is the Local NIS and DNS option during installation.

Installation Worksheet

Date March 1, 1999

Prepared by Franklin Thomas

1

▼ Prerequisites ▼

NetWare Server SFO-ARGOS

Minimum Setup Requirements:

- Server running NetWare 4 version 4.1 (or later)
- 12 megabytes (MB) of RAM on the server to run all services and an additional 4 MB to run the DynaText viewer (in addition to the RAM requirement for NetWare 4)
- 5 MB of free disk space on SYS: volume for the software
- Correct frame encapsulation?
- DOS resident in memory?
- TCP/IP loaded and configured?

2

▼ Installation Information ▼

Drive or Path for Source Files A:

Hostname SFO-ARGOS

Boot Drive C:

Do you want to install online documentation? Yes No

NIS Domain Name argos

NIS Server (IP Address) 140.32.12.1

DNS Domain Name argos.com

DNS Server (IP Address) 140.32.12.1

Host Information Worksheet

The Host Information worksheet lists the name of each host in the network and the associated IP address. This list should also contain the NetWare server's hostname and IP address.

For more information on administering hosts and hostgroups, see *Novell DNS/DHCP Services Administrator's Guide*.

See "Host Information Worksheet Example" on page 64 for a sample of how to use this worksheet.

Host Information Worksheet Example

The sample worksheet contains the host IP address for the Argos NetWare server running NetWare Print Services and the host IP address of a workstation located in the publications department. The worksheet also contains the IP address of the UNIX host in the marketing department.

Host Information Worksheet

Date March 1, 1999
Prepared by Franklin Thomas

Hostname	IP Address
sfo-argos	140.32.12.1
doswrk1	140.32.12.2
madrid	140.32.11.1

User Information Worksheet

The User Information worksheet contains the NetWare usernames and the UNIX usernames of the users sharing files and print services through the NetWare Print Services server. Each user must have a NetWare user account and a UNIX user account. Enter a user ID (UID) number and primary group ID (GID) number for each UNIX user account.

The NetWare users do not have a UID or GID until you assign them one on the UNIX system.

If you plan to import the UNIX user information from another server, use this worksheet only to keep a record of your user list or the NetWare account passwords that you enter. For more information on importing the UNIX user information, see “Configuring the Name Service Database” on page 98.

For more information on administering user accounts, see “Managing User and Group Information” on page 137.

See “User Information Worksheet Example” on page 66 for a sample of how to use this worksheet.

User Information Worksheet Example

The sample worksheet contains the names of the NetWare users in the Argos publications department and the UNIX users in the marketing department. It is recommended that you use the same username for both the NetWare and UNIX accounts.

Figure 2-3
Worksheet Example

User Information Worksheet

Date March 1, 1999

Prepared by Franklin Thomas

NetWare Username	UNIX Username	UID	Primary GID
bobd	bobd	<div style="border: 1px solid black; padding: 5px; text-align: center;"> Fill in the UID for the NetWare user after assigning a UID on the UNIX system. </div>	<div style="border: 1px solid black; padding: 5px; text-align: center;"> Fill in the GID for the NetWare user after assigning a GID to their group on the UNIX system. </div>
leslief	leslief		
harryb	harryb		
frankf	frankf		
chrish	chrish		
tienw	tienw		
bdoover	bdoover	556	889
mbrown	mbrown	557	889
breynolds	breynolds	1242	889
thogue	thogue	559	889
drakers	drakers	600	889

Group Information Worksheet

The Group Information worksheet contains the NetWare groupname and the UNIX groupname of each group sharing files and print services through the NetWare Print Services server.

If you plan to import the UNIX group information from another server, use this worksheet only to keep a record of your group list. For more information on importing the UNIX group information, refer to “Specifying Users, Groups, and Hosts” on page 99.

For more information on administering groups, see “Managing User and Group Information” on page 137 under “Managing.”

See “Group Information Worksheet Example” on page 68 for a sample of how to use this worksheet.

Group Information Worksheet Example

The sample worksheet contains the names of the NetWare groups in the Argos publications department, the names of the UNIX groups in the marketing department, and a GID number for each UNIX group.

Figure 2-4
Example Worksheet

Group Information Worksheet

Date March 1, 1999
Prepared by Franklin Thomas

NetWare Groupname	UNIX Groupname	GID
		<div style="border: 1px solid black; padding: 5px; width: fit-content;">Fill in this number for the NetWare groups after assigning them a GID on the UNIX system.</div>
pubstaff	pubstaff	889
mktstaff	mktstaff	890

UNIX-to-NetWare Print Worksheet

The UNIX-to-NetWare Print worksheet lists the information required to configure the UNIX-to-NetWare Print Services.

Section 1 identifies the default NetWare user account.

Section 2 identifies the print queue, the type of filter, the name of the print-job configuration, and all trusted hosts.

For more information on UNIX-to-NetWare printing, see “Managing Print Services” on page 172.

See “UNIX-to-NetWare Print Worksheet Example” on page 70 for a sample of how to use this worksheet.

UNIX-to-NetWare Print Worksheet Example

The NetWare printer at the Argos company is capable of high-resolution printing on both sides of the page. This capability is often needed by the UNIX users in Marketing. The UNIX-to-NetWare Print Service permits them to use the printer, as is shown in Figure 2-5 on page 71.

Figure 2-5
UNIX-to-NetWare Print Service

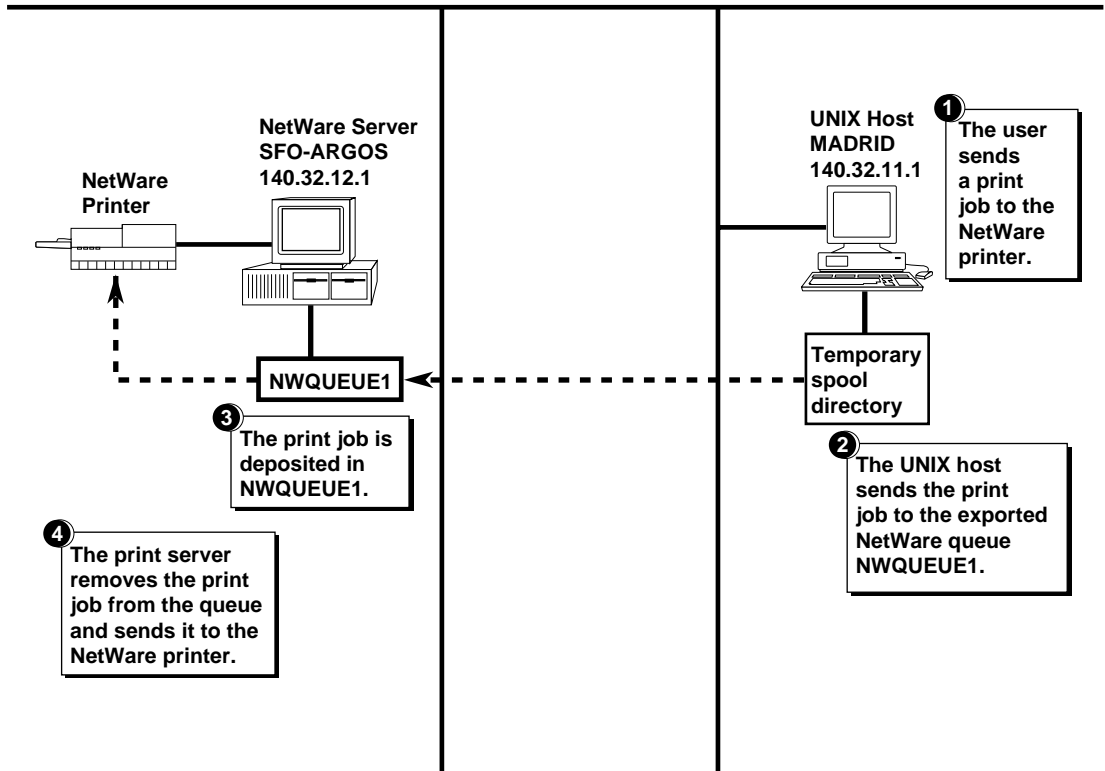

As the sample worksheet illustrates, the Publications department chooses not to use the default account. (The Yes option assigns the default NetWare user account to all users.) The Publications department does not want everyone to have the same access. The Print Spool Volume and Print Spool Directory are also listed in this section of the worksheet. The Publications department chooses to use the defaults for the Print Spool Volume (SYS:) and for the Print Spool Directory (ETC/LPDSPPOOL).

UNIX-to-NetWare Printing Worksheet

Date March 1, 1999
 Prepared by Franklin Thomas

1

▼ Default Account and Print Spool ▼

Default NetWare User Account GUEST
 Always Use the Default NetWare Account (Default: No) Yes No
 Print Spool Volume SYS:
 Print Spool Directory ETC/LPDSPool

▼ Exported Queue Configuration ▼

2

Exported NetWare Queue	Filter	NetWare Print Job Configuration (optional)	Trust All Hosts	Trusted Hosts and Hostgroups
NWQUEUE1	Lineprinter	PUBCON	✓	

List names here if "Trust All Hosts" column is not checked.

NetWare-to-UNIX Print Worksheet

The NetWare-to-UNIX Print worksheet lists the information required to configure the NetWare-to-UNIX Print Service. For each UNIX printer, you need the name of the UNIX host attached to the printer and the corresponding NetWare name and queue.

Section 1 identifies the default NetWare print server, UNIX user account, and print spool.

Section 2 identifies the UNIX printer and the printer host. Because NDS™ needs an object name to identify the UNIX printer, you must provide an NDS printer name for the UNIX printer. You must also identify at least one NetWare queue in Section 2.

For more information on NetWare-to-UNIX printing, see “Managing Print Services” on page 172.

See “NetWare-to-UNIX Print Worksheet Example” on page 73 for a sample of how to use this worksheet.

NetWare-to-UNIX Print Worksheet Example

The Argos company wants a user on the DOS workstation to be able to send a print job to the UNIX printer Sparky. Figure 2-7 on page 74 shows how the NetWare-to-UNIX print service can be configured to send the job via the NetWare queue named NWQUEUE2.

Figure 2-7
NetWare-to-UNIX Print Services

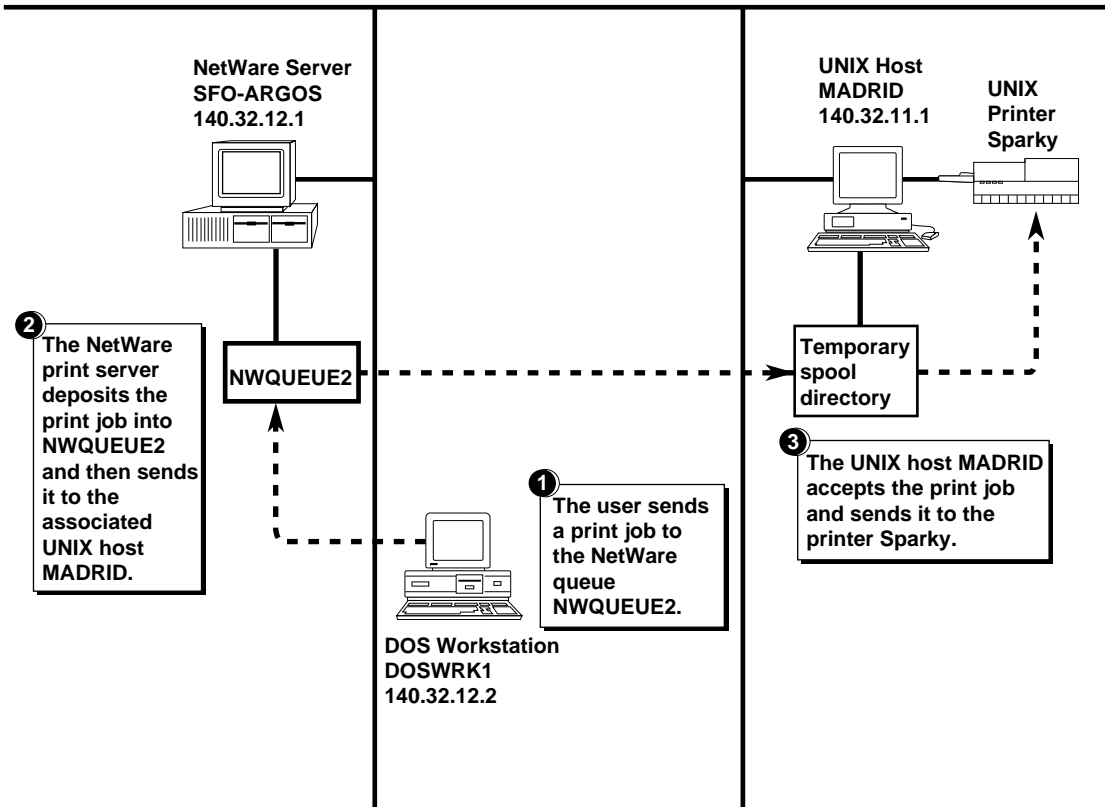

As the sample worksheet illustrates, the Publications department chooses not to use the default UNIX user account. (The Yes option would assign the default UNIX user account to all users.) The Publications department does not want everyone to have the same access.

NetWare-to-UNIX Printing Worksheet

Date March 1, 1999
Prepared by Franklin Thomas

▼ Default Account, Print Server, and Print Spool ▼

1

Default NetWare Print Server Name SFO-ARGOS
Default UNIX User Account GUEST
Always Use the Default UNIX Account (Default: No) Yes No
Print Spool Volume SYS:
Print Spool Directory ETC/LPDSPPOOL

▼ UNIX Printer Setup ▼

2

UNIX Printer Name SPARKY
UNIX Hostname MADRID
NDS Printer Name SPARKY
NetWare Queues Serviced NWQUEUE2

Planning Worksheets

This section provides the planning worksheets you must complete before installing and configuring the NetWare Print Services product. The worksheets are:

- ◆ “Installation Worksheet Definition Page” on page 77
- ◆ “Host Information Worksheet Definition Page” on page 79 (one copy for every 17 hosts)
- ◆ “User Information Worksheet Definition Page” on page 81 (one copy for every 17 users)
- ◆ “Group Information Worksheet Definition Page” on page 83 (one copy for every 17 groups)
- ◆ “UNIX-to-NetWare Print Services Information Worksheet Definition Page” on page 85
- ◆ “NetWare-to-UNIX Print Service Information Worksheet Definition Page” on page 87

Make a copy of each worksheet prior to beginning the installation and configuration process. Make multiple copies of each worksheet as required.

You will find a definition page and a worksheet page for each of the eight worksheets. The definition page contains information explaining each field on the corresponding worksheet.

Installation Worksheet Definition Page

Minimum Setup Requirements—the minimums needed to run NetWare Print Services. If you do not meet the minimum requirements, you may experience problems with NetWare Print Services. Check each box as you verify each item.

Installation Information—information required prior to installing NetWare Print Services. Write the information on the line adjacent to each item.

Drive or Path for Source Files—the disk drive or path from which you will be installing the NetWare Print Services product. For example, if you are installing from floppy diskettes and using your A:\ drive, write “A:\” on the adjacent line.

Hostname—the name of the host system where you will be installing NetWare Print Services. For example, if your NetWare server is SFO-ARGOS, write “SFO-ARGOS” on the adjacent line.

Boot Drive—the name of the boot drive for the NetWare Print Services. For example, if your boot drive is the C:\ drive, write “C:” on the adjacent line.

Install Online Documentation?—Installing the online documentation is optional. However, some documentation is available online only.

NIS Domain Name—the name of the NIS Domain where you are installing NetWare Print Services. For example, if the name of your NIS Domain is argos, write “argos” on the adjacent line.

NIS Server (IP Address)—the IP address of the NIS Server. For example, if your NIS Server has an IP address of 140.32.12.1, write “140.32.12.1” on the adjacent line.

DNS Domain Name—the name of the DNS Domain where you are installing NetWare Print Services. For example, if your DNS Domain name is argos.com, write “argos.com” on the adjacent line.

DNS Server (IP Address)—the IP address of the DNS Server. If you are using the same server for NIS and DNS, the IP address will be the same. If NIS and DNS are using different servers, enter the IP address of the DNS Server on the adjacent line.

Installation Worksheet

Date _____

Prepared by _____

▼ Prerequisites ▼

NetWare Server _____

Minimum Setup Requirements:

- Server running NetWare 4 version 4.1 (or later)
- 12 megabytes of RAM on the server to run all services and an additional 4 megabytes to run the DynaText viewer (in addition to the RAM requirement for NetWare 4)
- 5 megabytes of free disk space on SYS: volume for the software
- Correct frame encapsulation?
- DOS resident in memory?
- TCP/IP loaded and configured?

1

▼ Installation Information ▼

Drive or Path for Source Files _____

Hostname _____

Boot Drive _____

Do you want to install online documentation? Yes No

NIS Domain Name _____

NIS Server (IP Address) _____

DNS Domain Name _____

DNS Server (IP Address) _____

2

Host Information Worksheet Definition Page

This worksheet has two categories: Hostname and IP Address.

Hostname—list the hostnames for all machines that will use NetWare Print Services. For example, if you have three hosts named sfo-argos, doswk1, and madrid for use with NetWare Print Services, write “sfo-argos” “doswk1” and “madrid” in the Hostname column.

IP Address—list the IP address for each hostname. For example, the IP addresses for sfo-argos, doswk1, and madrid are 140.32.12.1, 140.32.12.2, and 140.32.11.1, respectively.

User Information Worksheet Definition Page

NetWare Username—the username the user types when logging in to the NetWare server. The username can contain up to 31 characters. Normally, this username is the same as the UNIX username.

UNIX Username—the username of the UNIX user. List each username that you want to have NetWare Print Services access. Normally, this username is the same as the NetWare username.

UID—the UNIX user ID number. UNIX systems use the UID number to identify files and directories owned by a user. Valid UID numbers are integers between 0 and 65,535. Each user should have a unique UID.

Primary GID—the group ID for the group to which the user belongs. UNIX systems use the GID number to identify groups associated with UNIX files that the user creates. Valid GID numbers are integers between 0 and 65,535.

Group Information Worksheet Definition Page

This worksheet has three categories: NetWare Groupname, UNIX Groupname, and GID.

NetWare Groupname—the name of the NetWare group. This name corresponds to the UNIX Groupname.

UNIX Groupname—the name of the UNIX group. This name corresponds to the NetWare Groupname.

GID—the UNIX group ID number. This number corresponds to the UNIX primary group identification. The GID number identifies the group associated with UNIX files that the user creates. Valid GID numbers are integers between 0 and 65,535.

UNIX-to-NetWare Print Services Information Worksheet

Definition Page

This worksheet has two sections: Default Account and Print Spool, and Exported Queue Configuration.

The Default Account and Print Spool section contains the following fields:

Default NetWare User Account—the NetWare user account that you want to use as a default.

Always Use the Default NetWare Account—whether to use the default account for all users accessing the print service.

Print Spool Volume—the volume on which the spool directory resides. The default volume is SYS:.

Print Spool Directory—the path to the print spool directory. The default path is ETC/LPDSPOOL.

The Exported Queue Configuration section contains the following fields:

Exported NetWare Queue—the names of all exported NetWare queues.

Filter Field—the type of filter associated with each exported queue. The three choices are Line Printer, PostScript, and None.

Print Job Configuration—the print job configuration used for all print jobs spooled to this exported queue.

Trust All Hosts and Hostgroups—whether all UNIX hosts are authorized to send print jobs to the queue. Yes authorizes all UNIX hosts to send print jobs. No means you must list each UNIX host and hostgroup explicitly in the Trusted Hosts and Hostgroup field.

Trusted Hosts and Hostgroups—the UNIX hosts and hostgroups that can access the UNIX-to-NetWare print service using the specified exported queue.

UNIX-to-NetWare Printing Worksheet

Date _____

Prepared by _____

▼ Default Account and Print Spool ▼

1

Default NetWare User Account _____

Always Use the Default NetWare Account (Default: No) Yes No

Print Spool Volume _____

Print Spool Directory _____

▼ Exported Queue Configuration ▼

2

Exported NetWare Queue	Filter	NetWare Print Job Configuration (optional)	Trust All Host	Trusted Hosts and Hostgroups

NetWare-to-UNIX Print Service Information Worksheet

Definition Page

This worksheet has two sections: Default Account, Print Server, and Print Spool, and UNIX Printer Setup.

The Default Account, Print Server, and Print Spool section contains the following fields:

Default NetWare Print Server Name—the name of the default print server used for NetWare-to-UNIX printing.

Default UNIX User Account—the username for the default UNIX user account. This default account is used if a user who does not have a mapped UNIX account attempts to use the print service.

Always Use the Default UNIX Account—whether to use the default UNIX account for all users that use the print service.

Print Spool Volume—the volume on which the spool directory resides. The default volume is SYS:.

Print Spool Directory—the path to the print spool directory. The default path is ETC/LPDSPOOL.

The Exported Queue Configuration section contains the following fields:

UNIX Printer Name—the UNIX name for the printer.

UNIX Hostname—the UNIX host to which the printer is attached.

NDS Printer Name—the NetWare NDS object name for the UNIX printer.

NetWare Queues Serviced—the NetWare queues that can send print jobs to the specified UNIX printer. You must specify at least one queue to configure the printer.

NetWare-to-UNIX Printing Worksheet

Date March 1, 1999
Prepared by Franklin Thomas

▼ Default Account, Print Server, and Print Spool ▼

1

Default NetWare Print Server Name SFO-ARGOS
Default UNIX User Account GUEST
Always Use the Default UNIX Account (Default: No) Yes No
Print Spool Volume SYS:
Print Spool Directory ETC/LPDSPPOOL

▼ UNIX Printer Setup ▼

2

UNIX Printer Name SPARKY
UNIX Hostname MADRID
NDS Printer Name SPARKY
NetWare Queues Served NWQUEUE2

Before you begin the installation procedure, make sure that you meet the installation prerequisites. After installing, you have to configure the software before you can use it.

Note that the procedure for reinstalling or upgrading your NetWare® Print Services for UNIX* is different from the procedure used for a first-time installation.

Installing NetWare Print Services for UNIX

This section describes how to install the NetWare Print Services for UNIX software. This section contains the following:

- ◆ “Meeting the Installation Prerequisites” on page 90
- ◆ “Preparing for Installation” on page 90
- ◆ “Using Other TCP/IP Products” on page 92
- ◆ “Reinstalling or Upgrading the Software” on page 93
- ◆ “Installing the Software on a NetWare Server” on page 94

For last-minute information that is not included in this documentation, please refer to the README.TXT file included on the product CD-ROM.

Meeting the Installation Prerequisites

Before you install the NetWare Print Services software, your system must meet the following prerequisites:

- The NetWare® server must be running NetWare software, version 4.1 or later.
- A total of 12 MB of RAM, in addition to the RAM requirements for NetWare, is needed to run UXPS.
- The SYS: volume requires free disk space of 8 MB for the software.
- TCP/IP must be loaded and configured (refer to the documentation about TCP/IP in *Novell Internet Access Server 4.1 Routing Concepts*).

Preparing for Installation

Before you install the NetWare Print Services for UNIX software, the following must be true:

- ◆ The NetWare TCP/IP stack on the NetWare file server must be bound to the Ethernet_II frame type. (Refer to the NetWare 5 documentation for complete details on specifying multiple frame types and binding multiple protocols.)
- ◆ DOS must be running during installation. If you have used the REMOVE DOS command, you must bring down and restart the server and leave DOS running while installing this product. If the console command REMOVE DOS has been added to the AUTOEXEC.NCF file, you must remove this line before you reboot. DOS is not necessary during normal operation; only during installation.
- ◆ You must specify the NDS™ context for NetWare Print Services (see “Defining the Default NDS Context” on page 91 for details).
- ◆ If you already run other TCP/IP-based software on your NetWare server, you should edit the file SYS:\ETC\NWPARAMS as described in “Using Other TCP/IP Products” on page 92.

Defining the Default NDS Context

The NetWare Print Services product incorporates the idea of a default NDS context. This represents the UXPS “current working directory” of the NetWare Print Services software in terms of NDS access. The default NDS context simplifies the location where most of your NetWare objects such as users, groups, and printers may reside.

The default NDS context is determined as follows:

- ◆ If the bindery context is set on the server, this context is used.

When you install NetWare 5 on your server, the Server object is created in a container object. In addition, the bindery context is set for this container object level. The bindery context can be reset with the SET command.

To view the server’s current bindery emulation context, type the following:

```
SET BINDERY CONTEXT <Enter>
```

- ◆ If the bindery context is not set, the NetWare server’s location in the NDS tree is used.

For example, if your server has a complete name of .CN=NWserver.OU=pubs.O=acme, the default NDS context will be OU=pubs.O=acme.

- ◆ You can force the default NDS context for NFS services to be any explicit container object, independent of the bindery context.

To set the default NDS context, modify the NDS_CONTEXT parameter in the SYS:ETC\NWPARAMS file by typing the following command at the console prompt:

```
LOAD EDIT SYS:ETC\NWPARAMS <Enter>
```

Note: If this file does not exist on the server, copy it manually from the product CD-ROM to the SYS:ETC directory. On the NetWare Print Services for UNIX CD-ROM it will be in the directory \NWUXPS\ETC.

Using the Down-arrow key, scroll to the [NETDB] section of the file and change the value for the NDS_CONTEXT parameter.

For example, if the server volumes are located in OU=Department.O=Company, the line for this parameter would be changed to

```
NDS_CONTEXT      OU=Department.O=Company
```

If you change the location of the default NDS context (either by resetting the bindery context or modifying NWPARAMS as described above), reinitialize the NetWare Print Services software by issuing the following commands from the console:

```
UNISTOP
```

```
LOAD UNICON /L PRTS <Enter>
```

At the login prompt, be sure to specify the ADMIN user or a user with sufficient rights (for these rights, see “Installing the Software on a NetWare Server” on page 94). This reinitializes NetWare Print Services for UNIX to work correctly using the new default NDS context. After NetWare Print Services for UNIX is reinitialized, UNICON will unload. At the console, issue the following command:

```
UNISTART
```

Using Other TCP/IP Products

This product maintains its hosts database under a centralized name service called DNS. Other TCP/IP products running on the server may rely on a local file called SYS:ETC/HOSTS for host information. If you have such products on your server, you can set the WRITELOCALFILES parameter in the SYS:ETC/NWPARAMS file to prevent the local file from being deleted. This condition is called compatibility mode.

To set the flag, type the following command at the console prompt:

```
LOAD EDIT SYS:ETC\NWPARAMS <Enter>
```

Note: If this file does not exist on the server, copy it manually from the product CD-ROM to the SYS:ETC directory. On the NetWare Print Services for UNIX CD-ROM it will be in the directory \NWUXPS\ETC.

Using the Down-arrow key, scroll to the [NETDB] section of the NWPARAMS file. Set the value for the WRITELOCALFILES parameter to 1. If you do not find this parameter in the NWPARAMS file, add the following entry to the [NETDB] section:

```
WRITELOCALFILES 1
```

Reinstalling or Upgrading the Software

Reinstalling or upgrading your NetWare Print Services for UNIX requires different procedures than a first-time installation. To reinstall or upgrade your NetWare Print Services for UNIX software, do the following:

1. **Remove the current NFS/UXPS software as described in “Removing the NetWare Print Services for UNIX Software” on page 319.**

Do not remove any of the files that remain on the server.

2. **Complete Steps 1 through 12 of “Installing the Software on a NetWare Server” on page 94.**

The installation program displays the Available Name Service Options menu.

3. **Select the same name service option that you selected during the first installation and press <Enter>.**

4. **To continue, press <Esc>.**

The installation program prompts you to enter NIS and DNS name server IP address information.

5. **Accept the default information provided and press <Esc>.**

Accepting the default information preserves your current configuration.

A confirmation box is displayed.

6. **Select Yes and press <Enter>.**

The program displays a confirmation box about initializing NIS database.

7. Select No and press <Esc>.

Selecting No preserves your current configuration. Detailed status messages are displayed. The utility displays the Running Services Menu. Complete Steps 23 through 29 of “Installing the Software on a NetWare Server” on page 94 to complete the reinstallation or upgrade.

Installing the Software on a NetWare Server

To install the NetWare Print Services or NetWare Print Services for UNIX software for the first time, do the following:

- 1. Mount the product CD-ROM as a volume, either on the NetWare server where you will install the product or on a remote NetWare server.**

To mount a CD-ROM on a NetWare server, do the following:

- 1a. Insert the CD-ROM into a CD-ROM drive attached to the file server where the volume will be mounted.**

- 1b. At that server's console, type:**

LOAD CDROM

- 1c. At that server's console, type:**

CD DEVICE LIST

The console displays the available CD-ROM devices.

- 1d. At that server's console, type:**

CD MOUNT #

where # is the device number displayed by the “CD DEVICE LIST” command.

- 2. Start the NetWare installation program from the file server console by typing:**

NWCONFIG <Enter>

Note: You can get help at any time during the installation procedure by pressing <F1>. You can exit the installation program by pressing <F10>.

- 3. Select Product Options, and then select Install a Product Not Listed.**

The installation program prompts you for a path to the installation files.

- 4. Press <F3> and enter the correct path of the source software when prompted.**

Correct path is <CD-ROM>:\NWUXPS for print services. Here <CD-ROM> is the volume name if the product CD-ROM is mounted as a volume on this server, or the remote server name and volume name if the CD-ROM is mounted as a volume on another server.

- 5. If there is a README.TXT file, press <Esc> to continue.**

The program displays a confirmation box asking if you want to stop the installation and exit.

- 6. To continue, press <Enter>.**

If there is a README file, the program displays a message informing you that there is a README.TXT file.

- 7. Select Yes if you want to stop the installation to read the README.TXT file or No to continue the installation process.**

If you select Yes, the program brings up the README file in a text window. When you have finished reading, press <Esc> and then <Enter> to return to installation.

If you select No, the installation continues.

- 8. The installation program prompts you for the name of the host on which the product is being installed. Accept the displayed name, or type in the correct name and press <Enter>.**

The program checks for TCP/IP configuration and copies the product configuration files to the server. An Installation Status Messages screen describes what the installation program is doing.

If the installation program finds that TCP/IP is not configured, it displays a message indicating that you must configure TCP/IP before the installation can continue. The installation program waits at this point until you configure TCP/IP. Refer to *Novell Internet Access Server 4.1 Routing Concepts* for information.

- 9. The program prompts you for the location from which you boot the server. This is the location from which you enter the NetWare SERVER command to bring up the NetWare server. Accept the default drive C: as the boot drive or change it if appropriate, and press <Enter>.**

- 10. Enter the ADMIN username and password and press <Enter>.**

The installation program displays the Available Name Service Options menu.

For more information on the Name Service options, refer to “Installation Worksheet” on page 61.

Note: If this is not a new installation (you are reinstalling or upgrading an existing installation of NetWare Print Services for UNIX), do not continue with this procedure. Go to “Reinstalling or Upgrading the Software” on page 93 and follow that procedure.

- 11. Select the appropriate Name Service Option.**

The installation program displays the Setup Name Services form.

- 12. Modify the entries as necessary and press <Esc>.**

The default server address for each local database is the IP address of the server on which you are installing the product.

The utility asks if you want to continue to install name services.

- 13. Select Yes to continue installing.**

- 14. If you chose your local NetWare server as the master NIS server, the installation process creates your zone and database, and then starts your name services. Press <Esc> to continue.**

The installation program displays the Product Initialization Status screen. The installation process displays a message describing its progress and creates a UNIX Service Handler object in the NDS tree and grants appropriate NDS rights to that object.

- 15. When initialization is complete, the installation program prompts you to continue. To continue, press <Esc>.**

The installation program displays the Running Services menu.

Some services require configuration prior to use. See “Starting and Stopping Services” on page 117 for a list of services that require prior configuration.

- 16. To start a service now, press <Insert>.**

The installation program displays the Available Services screen.

- 17. Select a service that you want to start now.**

The installation program returns to the Running Services menu. If you selected a service, it appears in the Running Services list.

- 18. Repeat Step 16 and Step 17 to start each service that you want running.**

- 19. To exit the Running Services menu, press <Esc> twice.**

The installation program displays the Currently Installed Products list. The NetWare Print Services for UNIX product is now listed.

- 20. To exit the installation program, press <Esc> three times.**

The installation program displays a confirmation box.

- 21. Select Yes to exit the installation program or No to select another installation option.**

If you select Yes, the program exits, and you return to the console prompt.

- 22. If you were prompted to reboot your computer at the end of the installation, properly bring down and restart the server before you continue.**

The NetWare Print Services for UNIX software is now installed and running. Before it can be used, you must complete the configuration procedures described in “Configuring for the First Time” on page 98.

Configuring for the First Time

This section describes how to configure your NetWare Print Services for the first time. Before NetWare Print Services can be used, the software must be configured. This section describes the following:

- ◆ Incorporating UNIX users and hosts into your NetWare® network
- ◆ Converting the source information into your NIS database
- ◆ Planning checklists

Note: After you add UNIX users and hosts, use the information provided in the “Managing” on page 111 section to configure your NetWare Print Services. The “Planning Checklist” on page 107 identifies the tasks you must complete. Each task references procedures given in the “Managing” on page 111 section.

If you do not convert source files to set up your databases, you must manually add the data. See the “Planning Checklist” on page 107 for additional information regarding setting up your databases manually.

Configuring the Name Service Database

Importing the UNIX host, user, and group files is a quick way to load the data into the name service databases. If you did not select Local NIS and DNS during the name service portion of the installation, you do not need to complete all of the configuration procedures contained in this section.

Configuring the name service databases consists of different tasks depending on the name service option you selected during installation.

The following table lists the required tasks for each name service option.

Name Service Option	Required Configuration
Local NIS and DNS	Requires all configuration tasks: <ul style="list-style-type: none">◆ “Specifying Users, Groups, and Hosts” on page 99◆ “Initializing NIS” on page 102◆ “Mapping UNIX Accounts to NetWare Accounts” on page 103

Name Service Option	Required Configuration
Remote NIS and DNS	Requires the following configuration task: <ul style="list-style-type: none">◆ “Mapping UNIX Accounts to NetWare Accounts” on page 103

Specifying Users, Groups, and Hosts

If you select the Local NIS and DNS option, the NetWare server needs to have local access to information about the users and groups that will be accessing the NFS Services and the hosts they will be accessing.

If the user, group and host information is already available on a UNIX machine or another NetWare Print Services server, you can transfer those files as described in “Transferring UNIX Configuration Files from Another Host” on page 99. Alternatively, you can directly enter user, group and host information using the UNICON utility. If there is a lot of information, however, and it already exists on another machine, it will probably be much faster to transfer the files.

Adding Information with UNICON

The Manage Global Objects option in the UNICON main menu allows you to work with users, groups and hosts (as well as other information). To enter information, select the appropriate option from the Manage Global Objects menu (Manage Groups, Manage Hosts, or Manage Users) and follow the prompts from there. Press <F1> at any time for help information about a screen. For complete details, see “Managing Host Information” on page 121, “Managing Host Group Information” on page 133 and “Managing User and Group Information” on page 137 under “Managing.”

Transferring UNIX Configuration Files from Another Host

The NetWare file that controls UNIX user information is named `PASSWD`, the file that controls UNIX group information is named `GROUP`, and the file that controls host information is named `HOSTS`. All three files reside in the `SYS:ETC\DBSOURCE` directory on the NetWare server.

If you selected “Local NIS and DNS” during installation, you can transfer these files from your UNIX system to the NetWare server using the UNICON Copy Files Using FTP function.

Note: You can transfer the configuration files from a UNIX machine or from another NetWare server that uses NetWare NIS and DNS. To copy the files from another NetWare server, convert the database on the other server to a text file as described in “Backing Up the Master NIS Database” on page 219. NetWare source files are located in SYS:ETC\DBSOURCE.

Editing the Configuration Files

Configuration files may require editing to delete entries for users, groups, and hosts that will not have access to the NetWare Print Services. Deleting these entries ensures that NetWare entries are not created for them.

When the configuration files are edited depends on the size of the file.

If the files contain less than 64,000 bytes, you can use the UNICON Edit File function to edit them after you transfer them to the NetWare server. The UNICON Edit File function can only edit files with less than 64,000 bytes.

If the files contain more than 64,000 bytes, you can either use a UNIX text editor (such as vi) to edit them before you transfer them to the NetWare server, or you can use a DOS editor (such as EDIT) to edit them after the transfer.

Important: When you edit the hosts file, make sure it contains an entry for the NetWare Print Services server.

Transferring the Configuration Files

1. **Start at the UNICON Main Menu and make the following selections:**

- ☞ **Perform File Operation**
- ☞ **Copy Files Using FTP**

The utility displays the Server Login form.

If you have already used the Copy Files Using FTP option, UNICON displays a list of active FTP sessions from which you can choose. To log in to a new server from this list, press <Insert>.

2. **Enter the information for the machine that contains the files you want to transfer to the NetWare server.**

The utility displays the File Operations menu.

3. **Select Get File from the File Operations menu.**

The utility displays the Get File form.

4. **Type the passwd file path (usually /etc/passwd) into the Source filename field and press <Enter>. (If you created the passwd file from a database, the file may be located in a different directory, such as /tmp/passwd.)**

The utility moves the cursor to the Destination filename field.

5. **Type sys:etc/dbsource/nis/passwd into the Destination filename field and press <Enter>.**

The utility transfers the passwd file to the NetWare server.

6. **Type the group file path (usually /etc/group) into the Source filename field and press <Enter>. (If you created the group file from a database, the file may be located in a different directory, such as /tmp/group.)**

The utility moves the cursor to the Destination filename field.

7. **Type sys:etc/dbsource/nis/group into the Destination filename field and press <Enter>.**

The utility transfers the group file to the NetWare server. If you selected a remote DNS name server, continue with Step 8.

8. **Press <Esc>.**

The utility displays the Main Menu.

Initializing Local Name Services

After copying the hosts, passwd, and group files to the NetWare server, you must convert them into databases for use by the two name services: NIS and DNS. Both services must also be initialized.

Initializing NIS

Use the following procedure to create the NIS master database on your NetWare server. Initializing the database automatically starts the NIS server. Do not initialize NIS if you selected a remote NIS server during installation.

1. **Start at the UNICON Main Menu and make the following selections:**

- ↳ **Manage Services**

- ↳ **NIS**

- ↳ **Initialize Master NIS Maps**

The utility displays the name of the current NIS domain. By default, the name of the domain is the same as the name of the NetWare server.

2. **Accept the default domain name, and press <Esc>.**

The utility displays a confirmation box.

3. **Select Yes to convert the local files or No to cancel the operation.**

If you select Yes, the utility displays status messages as the database is created. Then a message is displayed stating whether the conversion was successful.

If you select Yes but currently have an existing NIS database, the utility displays a message informing you that the old database must be removed before a new one can be created.

4. **If you are prompted to remove an old database, press <Enter>. Select Yes to remove the old database or No to cancel the operation.**

If you select Yes, the utility displays status messages as the old database is removed and the new database is created.

Warning: If you select Yes, the old database is removed and all data is lost.

5. **To continue, press <Esc>.**

The utility displays the NIS menu.

6. **To return to the Main Menu, press <Esc> as many times as needed.**

Initializing DNS

For information on initializing DNS, refer to *Novell DNS/DHCP Services Administrator's Guide*.

Mapping UNIX Accounts to NetWare Accounts

After you create the NIS databases, you must match the NetWare user accounts and groups with the UNIX user accounts and groups. Creating this match is called mapping.

Converting UNIX User Accounts to NetWare User Accounts

Use this conversion process to map UNIX user accounts to NetWare user accounts. The conversion process maps each UNIX user account to an existing NetWare user account by the same name. If there is no NetWare user account by the same name, the utility creates one.

If a user has a NetWare account and a UNIX account with different account names, use the procedure described in “Mapping User Accounts” on page 156 to map the accounts manually.

If you do not understand the concept of mapping, refer to “Mapping User Accounts between NetWare and NFS” on page 29.

Important: UNIX user account conversion must be completed before you begin the group conversion. If you convert UNIX groups to NetWare groups before converting the user accounts, the NetWare groups that you create will not contain any members.

1. **Start at the UNICON *Main Menu* and make the following selections:**

- ↳ **Manage Global Objects**

- ↳ **Manage Users**

- ↳ **All Entries**

The utility displays the User list.

The user accounts listed in the UNIX User column are the user accounts you transferred from the UNIX host. An asterisk next to a UNIX user account means that there is a NetWare user account by the same name. The conversion process assumes that accounts with the same name belong to the same person.

2. **Mark all UNIX user accounts using <Shift+F7> and unmark all NetWare accounts using <F5>.**

Because this process only converts UNIX accounts, you must unmark all NetWare accounts before you proceed. If you attempt to continue without unmarking the NetWare accounts, you will receive an error message.

3. **To convert the UNIX user accounts, press <Enter>.**

The utility displays a confirmation box.

4. **Select Yes to confirm the conversion or No to cancel the conversion and return to the User list.**

If you select Yes, the utility displays a prompt asking you whether to use the existing user template when creating the NetWare user accounts.

5. **Select Yes to use the existing user template or No if you do not want to use the existing user template.**

The utility displays a prompt asking you whether to use the default password for all the NetWare user accounts.

6. **Select Yes to use a default password or No if you want to enter a different password for each new NetWare user account.**

If you select Yes, the utility begins the conversion and the process continues with Step 10. If you select No, the utility prompts you for a password as it creates each NetWare user.

7. **Type a password for each user when the utility prompts you and press <Enter>.**

The utility prompts you to re-enter the password.

8. **Retype the password and press <Enter>.**

The utility continues to convert UNIX users until all marked users are converted.

9. **To continue, press <Esc>.**

The utility redisplay the User list. The NetWare user accounts and the UNIX user accounts are mapped and appear in columns.

10. **To return to the Main Menu, press <Esc> twice.**

Converting UNIX Groups to NetWare Groups

This conversion process maps UNIX groups to existing NetWare groups of the same name, along with the mapped users within that group. If there is no NetWare group by the same name, the utility creates one.

If you have groups that have NetWare and UNIX accounts with different account names, use the procedure described in “Mapping Groups” on page 170 to map the accounts manually.

If you are not familiar with the concept of mapping, refer to “Mapping Groups between NetWare and NFS” on page 30.

Important: Complete the UNIX user account conversion process before you begin the group conversion. If you convert UNIX groups to NetWare groups before converting the user accounts, the NetWare groups that you create will not contain any members.

1. **Start at the UNICON *Main Menu* and make the following selections:**

- ↳ **Manage Global Objects**
- ↳ **Manage Groups**
- ↳ **All Entries**

The utility displays the Group list.

The groups listed in the UNIX Group column are the groups you transferred from the UNIX host. An asterisk next to a UNIX group means that there is a NetWare group by the same name.

- 2. Mark all UNIX groups using <Shift+F7> and unmark all NetWare groups using <F5>.**

Because this process only converts UNIX groups, you must unmark all NetWare groups before you proceed. If you attempt to continue without unmarking the NetWare groups, you will receive an error message.

- 3. To convert the UNIX groups, press <Enter>.**

The utility displays a confirmation box.

- 4. Select Yes to confirm the conversion or No to cancel the conversion and return to the Group list.**

If you select Yes, the utility displays a confirmation message as it converts the UNIX groups to NetWare groups.

- 5. To continue, press <Esc>.**

The utility returns to the Group list. The NetWare groups and the UNIX groups are mapped and appear in columns.

- 6. To return to the Main Menu, press <Esc> as many times as needed.**

Planning Checklist

Use the following checklist to determine which tasks you must perform to configure NetWare Print Services. You may not need to do all of them. Each task references applicable procedures in the “Managing” on page 111 section. Refer to that section for additional information.

- “Configuring Global Resources” on page 107
- “Configuring the NetWare-to-UNIX Print Service” on page 108
- “Configuring the UNIX-to-NetWare Print Service” on page 108
- “Configuring NIS” on page 109
- “Configuring FTP (File Transfer Protocol) Service” on page 109

Configuring Global Resources

If you did not set up the databases for your name services by copying the UNIX source files for hosts, users, and groups as explained in this section, you must do this manually. The following checklist items identify what to do.

- Add host entries
Refer to the procedures in “Managing Host Information” on page 121 and “Managing Host Group Information” on page 133.
- Create new NetWare user accounts and groups for each NetWare and NFS user and group that will access the NetWare Print Services
Refer to “Managing User and Group Information” for more information.

Configuring the NetWare-to-UNIX Print Service

Complete the following tasks to enable NetWare users to print to remote UNIX printers:

- Set up the remote host
- Select a default print server
- Configure the NDS™ UNIX printer object
- Assign a default UNIX user account (optional)
- Start the NetWare-to-UNIX print service

Refer to “Managing NetWare–to–UNIX Printing” on page 175.

Configuring the UNIX-to-NetWare Print Service

Complete the following tasks to enable remote UNIX users to print to NetWare printers:

- Set up the remote UNIX host
- Set up print job configurations (optional)
- Define the default exported queue configuration (optional)
- Export a NetWare queue
- Assign a default NetWare user account (optional)
- Start the UNIX-to-NetWare print service

Refer to “Managing UNIX–to–NetWare Printing” on page 187.

Configuring NIS

NIS databases are created during installation. Complete the following tasks if you need to add secondary name servers and replica databases:

- Create a replica database on a secondary NIS server

Refer to “Managing the Network Information Service (NIS)” for more information.

Configuring FTP (File Transfer Protocol) Service

If you would rather use the TFTP Service, which provides a trivial file transfer service (without authentication), you need only to start the service. Refer to “Starting and Stopping Services” on page 117 for more information.

Complete the following tasks to configure your FTP service:

- Set the FTP parameters and restrict FTP access.

For details, refer to “Setting the FTP Server Parameters” on page 264.

4 *Managing*

You can manage the NetWare® Print Services for UNIX* product by using the UNICON Administration utility.

Using this utility, you can manage information about hosts, host groups, user accounts and groups. Other tasks that can be performed include managing bidirectional print services, shared files, NIS, FTP and error reporting.

Managing with the UNICON Administration Utility

The UNICON administration utility allows you to administer various NetWare® products, including this one. This section introduces the utility and describes the configuration and management tasks it can perform.

- ◆ “Using the UNICON Utility” on page 112
- ◆ “Authorizing UNICON Access” on page 112
- ◆ “Starting the UNICON Utility” on page 113
- ◆ “Using UNICON Within a Procedure” on page 114
- ◆ “Using the Object Browser” on page 115

You can use UNICON to manage other NetWare products you may have installed on your server. The utility detects the presence of these products and displays the menu options that pertain to them. This section only describes how to use the UNICON options for this product.

Using the UNICON Utility

You can perform the following tasks using UNICON:

- ◆ Change to another server to configure and manage a different NetWare® server running UNICON
- ◆ Configure the server's global parameters
- ◆ Start and stop services
- ◆ Configure and manage services
- ◆ Configure error reporting
- ◆ Monitor the status of specific services
- ◆ Monitor operation and performance and adjust parameters affecting performance
- ◆ Configure user, group, host, and hostgroup information

Authorizing UNICON Access

Anyone with a NetWare® account and access to the server console can run UNICON. However, only users with the proper rights to the files and rights to configure the objects in the NDS™ tree can access and use all features.

As the NetWare administrator, you can delegate management tasks by providing some individuals with rights to allow them wider use of UNICON. NetWare includes groups that were established to give group members the rights they need to perform management tasks using UNICON. To delegate management tasks to a user, make the user a member of the group that has the rights that are required to perform the tasks you want to delegate.

The table Table 4-1 on page 113 shows how management tasks are divided by NetWare group name. The second column shows the specified group's area of responsibility. The third column shows the menu selections that can be accessed to perform the specified tasks.

Table 4-1
NetWare Accounts for Management Tasks

Group Name	Area of Responsibility	Authorized UNICON Menu Options
UNICON MANAGER	Full use of the UNICON utility	Access to all menu options
UNICON SERVICES MANAGER	Start, stop, and manage services	Start/Stop Services Manage Services
UNICON USER/GROUP MANAGER	Create, modify, and map users and groups	Manage Global Objects Manage Users (Groups)
UNICON HOST MANAGER	Modify host and hostgroup entries	Manage Global Objects Manage Hosts Manage Hostgroups

Starting the UNICON Utility

Use UNICON to complete the procedures in this section.

1. **Start the utility from the console prompt by typing**

```
LOAD UNICON <Enter>
```

The utility displays a login form with the server name filled in.

```

Server Login
-----
Server Name: sffomnyas
Username: admin,admin
Password:
  
```

2. **Type your authorized username in the Username field and press <Enter>.**
3. **Type your password in the Password field and press <Enter>.**

If the username and password are valid, the utility displays the Main Menu.

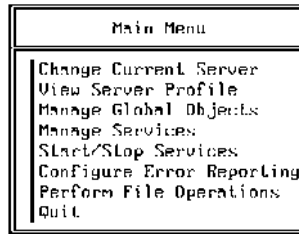

The header at the top of the screen shows the hostname or IP address of the NetWare server, the user login name, and the current NDS context.



If the username and password are not valid, you are denied access to the utility.

Using UNICON Within a Procedure

The remainder of this section assumes that you know how to access the server console and load UNICON.

All procedures begin with a graphic that shows you how to display the first UNICON screen you must use. For example, to display the Configure Error Logging Levels form, the first step would be presented as in the following example:

1. **Open the UNICON Main Menu.**
2. **Select Configure Error Reporting.**
3. **Select Configure Error Logging Levels.**
4. **Complete procedure and exit.**

Using the Object Browser

The UNICON utility's object browser allows you to navigate the NDS™ tree so that you can view, select, create, and delete objects anywhere in the tree. The browser enables you to manage product-specific objects throughout the NDS tree without returning to the NETADMIN (if you are using NetWare® 4) or NetWare Administrator (if you are using NetWare 5) utility. For example, if you are configuring UNIX*-to-NetWare printing using the UNICON utility and you need to designate a NetWare queue, you can use the browser to select a queue or create one anywhere in the directory tree.

Learning to Use the Browser

The browse screen appears when you press <Insert> within a prompt box or whenever you are provided with a list of available NDS objects. The following figure is an example of the UNICON utility's browse screen. This screen functions similarly to the browse screen provided with the NETADMIN utility of NetWare 4.



The + means that the object is a container. Objects without a + are leaf objects and cannot contain other objects. The +[...] marks the current container. This item appears only when it is appropriate to select an entire organizational unit (OU), such as when you are defining groups.

To browse up the directory tree to the parent container, choose +[...]. To browse down the directory tree, select objects with a + in front of them. When you select a container object, you can see all objects in that container.

To create an object, press <Insert>. To delete an object, highlight the object and press <Delete>. To select an object, highlight the object and press <Enter>. Where applicable, you can also use <F5> to select multiple objects.

Note: You cannot browse above the root level of the directory tree.

Using the Browser in a Procedure

Many UNICON options display a list of available NetWare objects from which you choose. When this type of list appears during a procedure, you can:

- ◆ Select an existing object from the current context by highlighting the object and pressing <Enter>.
- ◆ Create a new object of the same type in the current context by pressing <Insert> and providing appropriate identifying information (such as username if you are creating a new user).
- ◆ Use the browser to move to a different container and select an existing object by highlighting the object and pressing <Enter>.
- ◆ Use the browser to move to a different container and create a new object of the same type by pressing <Insert> and providing identifying information (such as a username if you are creating a new user).

The remainder of this section assumes that you understand how to use the browser.

Starting and Stopping Services

This section describes how to start and stop services. Some services require configuration before you can start them. Other services can be started but require configuration before they are functional. There are also services that only need to be started and require no configuration or management.

Important: You must create the appropriate global objects such as users, groups, and hosts to make these services functional.

See the following information to manage services:

- ◆ “Services that Require Configuration” on page 117
- ◆ “Services that Require No Configuration” on page 118
- ◆ “Starting a Service” on page 118
- ◆ “Binding the RARP Service” on page 119
- ◆ “Stopping a Service” on page 121

Services that Require Configuration

You must configure the following service before you can start it:

- ◆ NetWare®-to-UNIX* printing. You must select a default print server and configure the UNIX printers before starting this service.

If you try to start NetWare-to-UNIX printing before you configure it, you receive an error message. For more information on print service configuration, see “Managing Print Services” on page 172.

- ◆ FTP Server. You can configure the FTP service to suit your specific needs. If you start this service without changing any of the FTP parameters, the service uses the default configuration.
- ◆ NIS Server. You start the NIS server automatically during the installation process, unless you choose to use an existing NIS server on a different machine.

- ◆ UNIX-to-NetWare Printing. You must export the NetWare queues before UNIX hosts can submit print jobs.

Services that Require No Configuration

The following services require no configuration:

- ◆ RARP Server. You can start the RARP service from the command line if you need to use specific startup options. See “Binding the RARP Service” on page 119 for additional information.
- ◆ TFTP Server. Once you start this service, it loads automatically whenever the server receives a connection request.
- ◆ XConsole. You can start XConsole from the command line if you need to use specific startup options. See “Managing Remotely” on page 305 for additional information.

Starting a Service

Use this procedure to start a service.

1. **Start at the UNICON Main Menu and make the following selection:**

⇒ **Start/Stop Services**

The utility displays the Running Services list.

2. **Press <Insert>.**

The utility displays the Available Services list.

3. **Select the service that you want to start and press <Enter>.**

The service appears in the Running Services list.

4. **To return to the Main Menu, press <Esc>.**

The utility returns to the Main Menu.

Binding the RARP Service

RARP Service is a link-level protocol that maps physical addresses to IP addresses. When you use UNICON to start the RARP service, the RARP protocol binds to all boards that use one of the supported media types:

- ◆ ETHERNET_II
- ◆ ETHERNET_SNAP
- ◆ TOKEN-RING_SNAP
- ◆ IBM_TOKEN-RING_SNAP
- ◆ FDDI_SNAP
- ◆ IBM_PCN2_SNAP
- ◆ NOVELL_RX-NET

Starting RARP from the command line allows you to bind to a single media type, as described in the following section.

Binding RARP to a Single Media Type

Use the following procedure if you want to bind RARP to a single media type only.

1. **To start the RARP service from the command line, type**

```
LOAD RARPSERV DONT_BIND <Enter>
```

This command causes RARP to start without binding to any media types.

2. **To bind RARP to the appropriate media type, type**

```
BIND RARP TO LAN_DRIVER <Enter>
```

Binding RARP to the Same Media Type at Startup

Use the following procedure if you want RARP to bind to the same media type every time the server starts.

1. **Edit the UNISTART file and remove the following line:**

```
LOAD RARPSERV
```

2. **Edit the AUTOEXEC.NCF file and add the following lines after the line that reads “UNISTART”:**

```
LOAD RARPSERV DONT_BIND  
BIND RARP TO LAN_DRIVER
```

Important: You must add the preceding lines *after* the line that reads “UNISTART” or the RARP service will not load properly.

Binding RARP to an Unspecified Media Type

To bind RARP to an unknown media type, edit the AUTOEXEC.NCF file and add the following lines:

```
PROTOCOL ADD PROTOCOL_ID LAN_DRIVER  
BIND RARP TO LAN_DRIVER
```

Note: The AUTOEXEC.NCF file should already contain a line that loads the LAN driver supporting the media type.

For more information on adding and binding protocols in the AUTOEXEC.NCF file, refer to the NetWare® documentation.

Stopping a Service

Use this procedure to stop a service.

1. **Start at the UNICON Main Menu and make the following selection:**

↳ **Start/Stop Services**

The utility displays the Running Services list.

2. **Highlight the service you want to stop and press <Delete>.**

A confirmation box appears.

3. **Select Yes.**

The utility stops the service and removes it from the Running Services list.

4. **To return to the Main Menu, press <Esc>.**

The utility displays the Main Menu.

Managing Host Information

This section describes how to manage information about hosts. You should already be familiar with the concepts of hosts and IP addresses and understand how the NetWare® server keeps track of this information. If you are not familiar with hosts, refer to “Global Objects” on page 22.

This section discusses the following topics:

- ◆ “Identifying the NetWare Server as a Known Host” on page 122
- ◆ “Determining Your Host Update Rights” on page 122
- ◆ “Using the Host Management Screens” on page 124
- ◆ “Adding a Host in NIS” on page 130

- ◆ “Displaying or Modifying Host Information in NIS” on page 131
- ◆ “Deleting a Host in NIS” on page 132

Identifying the NetWare Server as a Known Host

Each remote machine that requires access to the NetWare® server (for file sharing or printing, for example) requires the following information in the `/etc/hosts` file.

- ◆ The NetWare server's hostname
- ◆ The IP address of the NetWare server

This identifies the NetWare server as a known host. For more information on adding a host entry, refer to the information in “Administration Procedures” on page 323.

Determining Your Host Update Rights

The Host Status inset enables you to determine whether you can update host information in the NIS database.

For updating host information in DNS, the master DNS Server database has to be updated using the appropriate administration utilities. Please refer to the client-based DNS/DHCP utilities documentation if you are using NetWare® DNS Server.

Displaying the Host Status Inset

1. To display the host status inset, start at the UNICON Main Menu and make the following selections:

- ↳ Manage Global Objects
 - ↳ Manage Hosts
 - ↳ Hosts

Update Rights: Granted	+ - Host is mapped to an NDS object.
------------------------	--------------------------------------

The inset also displays at the bottom of your screen during host administration.

2. Complete procedure and exit.

Understanding the Host Status Inset

The status inset contains the following field:

Update Rights—your right to update host information in the NIS database. If this field reads Granted, you have the right to update host information in NIS. If this field reads Denied, you do not have the right to update host information.

Note: If you are managing all host information through DNS, please do not use this option as this updates only the NIS database. Instead make use of the client-based DNS/DHCP utilities documentation for managing host information in DNS.

If you are denied the right to update host information, it may be for the following reasons:

- ◆ You do not have supervisory rights on this server.
- ◆ Your server is set up to use the DNS or NIS database on another server for host information. In this case, all host administration must be performed on the master DNS or NIS server.

Note: You can view information about the master servers by selecting the View Server Profile option from the UNICON Main Menu.

Using the Host Management Screens

Manage host information using the following UNICON screens:

- ◆ Hosts list
- ◆ Host information form
- ◆ Hostgroups list
- ◆ Hostgroup information list
- ◆ Hostgroup element menu

If you need information about a specific field on one of these screens, position the cursor in the field and press <F1>.

Hosts List

The hosts list displays all hosts in the DNS database. All host configuration procedures begin on this screen.

1. **To display the hosts list, start at the UNICON Main Menu and make the following selections:**
 - ↳ **Manage Global Objects**
 - ↳ **Manage Hosts**
 - ↳ **Hosts**



2. **Complete procedure and exit.**

Host Information Form

The Host Information form displays information about a specific host. Use this form to add a host or modify information about a host in NIS only.

Displaying the Host Information Form

To display the Host Information form, do the following.

1. **Start at the UNICON Main Menu and make the following selections:**

- ↳ **Manage Global Objects**
- ↳ **Manage Hosts**
- ↳ **Hosts**

The utility displays the hosts list.

2. **Select a host entry from the list.**

The utility displays the Host Information form.

Host Information	
Hostname:	juniper
Primary IP Address:	123.125.7.32
Primary Physical Address:	(not defined)
Aliases:	(see list)
Other IP Addresses:	(see list)
Machine Type:	(not defined)
Operating System:	(not defined)
NIS Object:	(not defined)

Understanding the Host Information Form

This form contains the following fields:

Hostname—the name of the host. The hostname can contain up to 46 characters.

Primary IP Address—the IP address that identifies the host. The information in this field must be in standard IP address format (for example, 123.26.9.31).

Primary Physical Address—the unique address assigned to each machine by the vendor who produces the machine. This address is a 6-byte hexadecimal number, such as 0x08 0x00 0x14 0x57 0x69 0x69.

Aliases—other names for the host. If the host has any aliases, these names are listed in the /etc/hosts file or in the NIS or DNS database. Select this field to display a list of known aliases for the host. You can add and delete known aliases using <Insert> and <Delete>.

Other IP Addresses—other host addresses. Select this field to display a list of alternate IP addresses for the host. You can add and delete other IP addresses using <Insert> and <Delete>.

Machine Type—the type of machine (for example, Sun* workstation).

Operating System—the operating system running on the machine (for example, SunOS*).

NDS Object—the name of the NDS™ object mapped to this host entry. The UNICON utility allows you to map a host entry to a corresponding NDS object so that you can manage all host entries using the NetWare® Administrator utility.

Hostgroups List

The hostgroups list shows all hostgroups in the NIS database. All hostgroup configuration procedures begin on this screen.

1. **To display the Hostgroups list, start at the UNICON Main Menu and make the following selections:**

- ↳ **Manage Global Objects**
- ↳ **Manage Hosts**
- ↳ **Hostgroups**



2. **Complete step and exit.**

Hostgroup Information List

The hostgroup information list shows all elements in a specific hostgroup. A hostgroup consists of one or more of these elements (described in the next section). Use this list to add and delete elements from a hostgroup.

Displaying the Hostgroup Information List

To display the hostgroup information list,

1. **Start at the UNICON Main Menu and make the following selections:**

- ↳ **Manage Global Objects**

- ↳ **Manage Hosts**

- ↳ **Hostgroups**

The utility displays the hostgroups list.

2. **Select a hostgroup.**

The utility displays the hostgroup information list.

Understanding the Hostgroup Information List

The left column lists the hostgroup *element*. An element can be the IP address of a host, a domain, a hostname, or the name of another hostgroup. The right column identifies the element type.

You can add and delete hostgroup elements using <Insert> and <Delete>.

Hostgroup Element Menu

The hostgroup element menu lists the elements you can add to a hostgroup. Use this menu to add an element to a hostgroup.

Displaying the Hostgroup Element Menu

To display the hostgroup element menu,

1. **Start at the UNICON Main Menu and make the following selections:**

- ↳ **Manage Global Objects**

- ↳ **Manage Hosts**

- ↳ **Hostgroups**

The utility displays the hostgroups list described in “Hostgroups List” on page 127.

2. Select a hostgroup.

The utility displays the hostgroup information list described in “Hostgroup Information List” on page 127.

3. Press <Insert>.

The utility displays the hostgroup element menu.

Element to Add
Address
DNS Domain
Host
Hostgroup

Understanding the Hostgroup Element Menu

This menu lists the following choices:

Address—the IP address for a host. The address entered in this field must be in standard IP address format (for example, 123.26.9.31).

DNS Domain—the name of a DNS domain. This element identifies all computers sharing the same DNS master as members of the hostgroup. The domain name entered in this field must be in standard domain name format (for example, argos.com).

Host—the hostname of a host. Select this field to display a list of hosts.

Hostgroup—a group of hosts, which can include hosts, hostgroups, IP addresses, and DNS domains. This element identifies all elements in the named hostgroup as members of the hostgroup. Select this field to display a list of hostgroups.

Adding a Host in NIS

Host information consists of a hostname and an IP address that the NetWare® server uses to locate other machines on the network. The host database must contain an entry for the server and an entry for each machine involved in file sharing or printing services.

If you are configuring the database for the first time, complete the Hosts worksheet found under “Planning.”

Use this procedure to add a host entry in NIS. If you are using DNS for managing hosts, please use the client-based DNS/DHCP administration utility to update hosts in your Master DNS server.

1. **Start at the UNICON Main Menu and make the following selections:**

- ↳ **Manage Global Objects**
- ↳ **Manage Hosts**
- ↳ **Hosts**

The utility displays the hosts list described in “Hosts List” on page 124.

2. **Press <Insert>.**

The utility prompts for the host’s name.

3. **Type the host’s name and press <Enter>.**

The utility prompts for the host’s IP address.

4. **Type the host’s IP address and press <Enter>.**

The utility displays the Host Information form described in “Host Information Form” on page 125.

5. **Fill in the form with the appropriate information and press <Esc>.**

The utility displays the hosts list. The new host appears on the list and is added to the NIS database.

6. **To return to the Main Menu, press <Esc> as many times as needed.**

The utility displays the Main Menu.

Displaying or Modifying Host Information in NIS

Warning: The local hostname is the name assigned to the NetWare® server. This name is used by the NIS and DNS name services. You should not delete or modify the local host name.

Use this procedure to display or modify host information in the NIS database only. To modify the hosts managed by DNS server, use the client-based DNS/DHCP administration utility.

1. **Start at the UNICON Main Menu and make the following selections:**

- ↳ **Manage Global Objects**
- ↳ **Manage Hosts**
- ↳ **Hosts**

The utility displays the hosts list described in “Hosts List” on page 124.

2. **Select a host.**

The utility displays the Host Information form described in “Host Information Form” on page 125.

3. **Select and modify the appropriate fields.**

You can add or delete an alias or other IP address by highlighting the appropriate field and pressing <Insert> or <Delete>.

4. **To exit the Hostname Information form, press <Esc>.**

The utility displays the hosts list.

5. **To return to the Main Menu, press <Esc> as many times as needed.**

The utility displays the Main Menu.

Deleting a Host in NIS

Warning: The local hostname is the name assigned to the NetWare® server. This name is used by the NIS and DNS name services. You should not delete or modify the local host name.

Use this procedure to delete a host entry from NIS. If you are using DNS for managing host information, please use the client-based DNS/DHCP utility for deleting hosts from DNS.

1. **Start at the UNICON utility's Main Menu and make the following selections:**

- ↳ **Manage Global Objects**
- ↳ **Manage Hosts**
- ↳ **Hosts**

The utility displays the hosts list described in “Hosts List” on page 124.

2. **Highlight the host to be removed and press <Delete>.**

The utility displays a confirmation box.

3. **Select Yes to delete the host or No to cancel the operation and redisplay the hosts list.**

If you select Yes, the utility deletes the host and redisplay the hosts list. The specified host no longer appears on the list.

4. **To return to the Main Menu, press <Esc> as many times as needed.**

The utility displays the Main Menu.

Managing Host Group Information

This section describes how to manage information about hostgroups. You should already be familiar with the concepts of hostgroups and IP addresses and understand how the NetWare® server keeps track of this information. If you are not familiar with hostgroups, refer to “Global Objects” on page 22.

This section discusses the following topics:

- ◆ “Adding a Hostgroup” on page 133
- ◆ “Adding Hosts to a Hostgroup” on page 134
- ◆ “Removing Hosts from a Hostgroup” on page 135
- ◆ “Deleting a Hostgroup” on page 136

Adding a Hostgroup

Use this procedure to add a hostgroup:

1. **Start at the UNICON Main Menu and make the following selections:**

- ↳ **Manage Global Objects**
- ↳ **Manage Hosts**
- ↳ **Hostgroups**

The utility displays the Hostgroups list described in “Hostgroups List” on page 127.

2. **Press <Insert>.**

The utility prompts for the hostgroup name.

3. **Type a name for the new hostgroup and press <Enter>.**

The utility displays an entry box for the new hostgroup. The list of hostgroup elements is empty.

4. **To add the first element to the hostgroup, press <Insert>.**

The utility displays the hostgroup element menu described in “Hostgroup Element Menu” on page 128.

5. **Select the type of element you want to add.**

The utility either prompts for additional information or lists the names of available elements of this type.

6. **Enter the appropriate information or select an element.**

The utility redisplay the list of available elements.

7. **Continue to add hostgroup elements until the hostgroup is complete.**

8. **To see the new hostgroup, press <Esc>.**

The utility displays the new hostgroup.

9. **To display the list of hostgroups, press <Esc>.**

The utility displays the Hostgroups list. The new hostgroup is listed.

10. **To return to the Main Menu, press <Esc> as many times as needed.**

The utility displays the Main Menu.

Adding Hosts to a Hostgroup

Use this procedure to add an element to a hostgroup:

1. **Start at the UNICON Main Menu and make the following selections:**

↳ **Manage Global Objects**

↳ **Manage Hosts**

↳ **Hostgroups**

The utility displays the Hostgroups list described in “Hostgroups List” on page 127.

2. Select a hostgroup.

The utility displays the hostgroup information list described in “Hostgroup Information List” on page 127.

3. Press <Insert>.

The utility displays the hostgroup element menu described in “Hostgroup Element Menu” on page 128.

4. Select the type of element you want to add.

The utility either prompts you for additional information or lists the names of available elements of this type.

5. Enter the appropriate information or select an element.

The utility redisplay the list of available elements.

6. To return to the Main Menu, press <Esc> as many times as needed.

The utility displays the Main Menu.

Removing Hosts from a Hostgroup

Use this procedure to remove an element from a hostgroup:

1. Start at the UNICON Main Menu and make the following selections:

↳ **Manage Global Objects**

↳ **Manage Hosts**

↳ **Hostgroups**

The utility displays the Hostgroups list described in “Hostgroups List” on page 127.

2. Select a hostgroup.

The utility displays a list of the elements in the hostgroup.

3. Highlight the element you want to delete and press <Delete>.

The utility displays a confirmation box.

4. **Select Yes to delete the element or No to cancel the operation and redisplay the hostgroup information list.**

If you select Yes, the utility deletes the element and displays the hostgroup information list. The specified element no longer appears on the list.

5. **To return to the Hostgroups list, press <Esc>.**

The utility displays the Hostgroups list.

6. **To return to the Main Menu, press <Esc> as many times as needed.**

The utility displays the Main Menu.

Deleting a Hostgroup

Use this procedure to delete a hostgroup:

1. **Start at the UNICON Main Menu and make the following selections:**

↳ **Manage Global Objects**

↳ **Manage Hosts**

↳ **Hostgroups**

The utility displays the Hostgroups list described in “Hostgroups List” on page 127.

2. **Highlight the hostgroup and press <Delete>.**

The utility displays a confirmation box.

3. **Select Yes to delete the hostgroup or No to cancel the operation and redisplay the Hostgroups list.**

If you select Yes, the utility deletes the hostgroup and redisplay the Hostgroups list. The specified hostgroup no longer appears in the list.

4. **To return to the Main Menu, press <Esc> as many times as needed.**

The utility displays the Main Menu.

Managing User and Group Information

This section describes how to manage NetWare® and UNIX* user accounts and groups. You should already be familiar with the concept of a user account and groups and understand how the NetWare server keeps track of user and group information. If you are not familiar with user accounts and groups, see “Global Objects” on page 22.

This section discusses the following topics:

- ◆ “Creating User Accounts and Groups on a UNIX System” on page 137
- ◆ “Determining Your User and Group Update Rights” on page 138
- ◆ “Filtering User and Group Information” on page 139
- ◆ “Using the User Management Screens” on page 140
- ◆ “Creating Groups” on page 163
- ◆ “Changing Information about Groups” on page 167
- ◆ “Mapping Groups” on page 170
- ◆ “Deleting a Group” on page 171

Creating User Accounts and Groups on a UNIX System

Users who want to share files or printers must have UNIX* user accounts and belong to a UNIX user group. To create UNIX user accounts and groups, follow the instructions included in your UNIX operating system documentation or refer to the procedures under “Administration Procedures” on page 323.

Hint: Using the NetWare® names to identify the UNIX user accounts and groups simplifies the task of mapping NetWare and UNIX user accounts and groups.

Determining Your User and Group Update Rights

The user and group status inset enables you to determine whether you can update user and group information.

Displaying the Status Inset

1. To display the status inset, start at the UNICON Main Menu and make the following selections:

- Manage Global Objects
 - Manage Users (Groups)

```
Update Rights: NetWare:Granted UNIX:Granted Mapping:Granted
```

The inset also displays at the bottom of your screen during user and group administration.

2. Complete procedure and exit.

Understanding the Status Inset

The user and group status inset contains the following fields:

Update Rights: NetWare—your right to update NetWare information. If this field reads **Granted**, you have the right to create and update NetWare user and group information. If this field reads **Denied**, you do not have the right to update NetWare user and group information.

If you are denied the right to update NetWare user and group information, it may be because you do not have supervisory rights.

Update Rights: UNIX—your right to update UNIX information. If this field reads **Granted**, you have the right to update UNIX user and group information. If this field reads **Denied**, you do not have the right to update UNIX user and group information.

If you are denied the right to update UNIX user and group information, it may be for the following reasons:

- ◆ You do not have supervisory rights on this server.
- ◆ Your server is set up to use an NIS master on another server. In this case, all UNIX administration must be performed on the master NIS server.

Update Rights: Mapping—your right to update mapping information. If this field reads Granted, you have the right to map NetWare user accounts and groups to UNIX user accounts and groups. If this field reads Denied, you do not have the right to map Netware and UNIX users and groups.

If you are denied the right to update NetWare user and group information, it may be because you do not have supervisory rights.

Filtering User and Group Information

UNICON includes options that enable you to filter the user and group lists.

Displaying the Filtering Options

1. To display the filtering options, start at the UNICON Main Menu and make the following selections:
 - ↳ Manage Global Objects
 - ↳ Manage Users (Groups)



2. Complete procedure and exit.

Understanding the Filtering Options

UNICON includes the following filtering options:

All Entries—shows all information. This default option provides no filtering.

By NetWare® Name—filters the user list by NetWare username and the group list by NetWare groupname. When you select this option, the utility prompts you to enter the filter. This option supports UNIX* wildcards (such as * and ?). For example, to view all NetWare user accounts starting with the letter A, type A* as the filter.

By UNIX Name—filters the user list by UNIX username and the group list by UNIX groupname. When you select this option, the utility prompts you to enter the filter. This option supports UNIX wildcards (such as * and ?). For example, to view all UNIX user accounts ending in SMITH, type *SMITH as the filter.

By UNIX UID (or UNIX GID)—filters the user list by UNIX UID and the group list by UNIX GID. When you select this option, the utility prompts you to enter the upper and lower boundaries of the filter. For example, you can list all UNIX user accounts that have UIDs between 0 and 200.

Using the User Management Screens

Manage user information using the following UNICON screens:

- ◆ User list
- ◆ UNIX* User Information form
- ◆ User Information form
- ◆ Group Membership list
- ◆ UNIX Detailed Information form

If you need information about a specific field on one of these screens, position the cursor in the field and press <F1>.

User List

The user list displays all current users in the NIS database. All user management procedures begin on this screen.

Displaying the User List

1. To display the user list, start at the UNICON Main Menu and make the following selections:
 - ↳ Manage Global Objects
 - ↳ Manage Users
 - ↳ All Entries

NetWare User	UNIX User
-----	newuser *
arnolds	arnolds
blower	blower
bold	bold
braynolds	braynolds
chrish	chrish
drakers	drakers
frankf	frankf
guzal	-----
harryb	harryb
lestief	lestief
sbroun	sbroun
newuser	----- *
supervisor	-----
lhogue	lhogue

2. Complete procedure and exit.

Understanding the User List

The left column lists NetWare user accounts. The right column lists UNIX user accounts.

Accounts that appear side by side are mapped. A dashed line next to an account means there is no corresponding mapped account. An asterisk to the right of both accounts means that a UNIX account and a NetWare account have the same name but are not mapped.

UNIX User Information Form

The UNIX User Information form displays UID and GID information for a single UNIX user account. Use this form to assign a UID and GID to a new UNIX user account.

Displaying the UNIX User Information Form

To display the UNIX User Information form,

1. **Start at the UNICON Main Menu and make the following selections:**

- ↳ **Manage Global Objects**
- ↳ **Manage Users**
- ↳ **All Entries**

The utility displays the user list described in “User List” on page 141.

2. **Press <Insert> and select either Create UNIX User or Create Both Users and Mapping.**

The utility prompts for the username.

3. **Enter the user’s username.**

The utility displays the UNIX User Information form.

UNIX User Information			
Username:	arnolds		
UID:	792	GID:	982

Understanding the UNIX User Information Form

This form contains the following fields:

Username—the username the user types to log in to the NetWare server or the UNIX host. A username can contain up to 31 characters. This field is informational only and cannot be edited.

UID—the user’s UID number. UNIX systems use the UID number to label files and directories owned by a user. Valid UID numbers are integers between 0 and 65,535. Each user should have a unique UID. When UNICON displays this form, it fills in the next available UID number automatically. You can override the utility’s choice by typing a number in this field.

GID—the user’s GID number. UNIX systems use the GID number to identify groups associated with UNIX files the user creates. Valid GID numbers are integers between 0 and 65,535. When the utility displays this form, it automatically displays the most recent GID number. You can override the utility’s choice by typing a number in this field.

User Information Form

The User Information form displays information about a single user. Use this form to modify user information.

Displaying the User Information Form

To display the User Information form,

1. **Start at the UNICON Main Menu and make the following selections:**
 - ↳ **Manage Global Objects**
 - ↳ **Manage Users**
 - ↳ **All Entries**

The utility displays the user list described in “User List” on page 141.

2. **Select a user.**

The utility displays the User Information form.

User Information			
NetWare User Information			
Username:	ARNOLDS		
Primary Groupname:	srnketstaff		
UNIX User Information			
Username:	arnolds	UID:	792
Primary Groupname:	srnketstaff	GID:	392
Detailed Info:	<see form>		
Group Membership:	<see list>		
Real Name:	Arnold Smith		
Change Password:	<not assigned>		

Understanding the User Information Form

This form contains the following fields:

NetWare User Information

Username—the user’s NetWare username. If no username is assigned, select this field to display a list of available NetWare users. Use this field to map an existing NetWare user account to an existing UNIX user account.

Primary Groupname—the NetWare group, which corresponds to the UNIX primary group.

UNIX User Information

Username—the user’s UNIX username. If no username is assigned, select this field to display a list of available UNIX users. Use this field to map an existing UNIX account to an existing NetWare account.

UID—the user’s UID number. UNIX systems use the UID number to label files and directories owned by a user. Valid UID numbers are integers between 0 and 65,535. You can change this value by typing a new UID.

Primary Groupname—the UNIX primary group to which the user is assigned. Select this field to view a list of UNIX groups. You can change this value by selecting a UNIX group from the list and pressing <Enter>.

GID—the user’s GID number. The GID number identifies the group associated with UNIX files the user creates. Valid GID numbers are integers between 0 and 65,535. You can change this value by typing a new GID.

Detailed Info—the user’s home directory and default shell. Select this field to display the information. You can change these values by typing in new ones.

Other Information

Group Membership—the groups to which the user belongs. Select this field to display a list of these groups. (This list is described in the next section.) You can add and delete groups using <Insert> and <Delete>.

Real Name—the user’s name.

Change Password—the field used to set or change the password for a user. The password changes on the UNIX side as well only if you are using NetWare NIS to manage your UNIX machines.

Group Membership List

The group membership list displays the groups to which a user belongs. Use this list to add the user to a group or remove the user from a group.

Displaying the Group Membership List

To display the group membership list,

1. **Start at the UNICON Main Menu and make the following selections:**

- ↳ **Manage Global Objects**

- ↳ **Manage Users**

- ↳ **All Entries**

The utility displays the user list described in “User List” on page 141.

2. **Select a user.**

The utility displays the User Information form described in “User Information Form” on page 143.

3. Select the group membership field.

The utility displays the group membership list.

NetWare Group	UNIX Group
everyone	-----
srnketstaff	srnketstaff
<<newgroup>>	newgroup

Understanding the Group Membership List

The left column lists the NetWare groups of which the user is a member. The right column lists the UNIX groups of which the user is a member.

Groups that appear side by side are mapped. A dashed line next to a group means there is no corresponding mapped group. Double brackets around a group means there is a corresponding mapped group, but the user is not a member.

Add or delete a group by using <Insert> or <Delete>.

UNIX Detailed Information Form

The UNIX Detailed Information form displays default UNIX information for a user. Use this form to change information about a UNIX user.

Displaying the UNIX Detailed Information Form

To display the UNIX Detailed Information form,

1. **Start at the UNICON Main Menu and make the following selections:**
 - ↳ **Manage Global Objects**
 - ↳ **Manage Users**
 - ↳ **All Entries**

The utility displays the user list described in “User List” on page 141.

2. **Select a user.**

The utility displays the User Information form described in “User Information Form” on page 143.

3. **Select the UNIX Detailed Information field.**

The utility displays the UNIX Detailed Information form.



UNIX Detailed Information	
Home Directory:	/home/arnolds
Default Shell:	/bin/csh

Understanding the UNIX Detailed Information Form

This form contains the following fields:

Home Directory—the user’s home directory.

Default Shell—the path of the user’s default shell. The default shell is the UNIX shell that is invoked when the user logs in to the UNIX host.

Creating User Accounts

To allow users to access remote files and use bidirectional printing, you must create corresponding UNIX* and NetWare® user accounts on the NetWare server.

The information you need to create these accounts is included in the User Worksheet under “Planning” on page 59.

Hint: Identifying a new NetWare user account with the same name as the UNIX user account simplifies the task of mapping the accounts.

Choose one of the following methods to create user accounts:

- ◆ Create a single user account. This method allows you to create each user account individually. You can create the NetWare account, the UNIX account, and the mapping between the accounts at the same time. You will usually use this method to add a user account after the initial configuration is complete.
- ◆ Convert UNIX user accounts. This method allows you to create multiple user accounts by converting existing UNIX accounts to NetWare accounts. You will usually use this method during the initial configuration.

Note: The following procedures assume you have the right to update both NetWare and UNIX information. If you do not have the right to update UNIX information, some of the prompts you receive may differ from the prompts in the procedures. For example, if you are creating a user account and you do not have the right to update UNIX information, you are not offered the option of creating a UNIX account.

Creating a Single User Account

Note: This procedure creates the UNIX user information stored in the PASSWD file or in the equivalent NIS database. You must also create the user accounts on the UNIX system unless you are using the NetWare NIS server to manage your UNIX machines and the accounts already exist.

Use this procedure to create a single user account:

1. **Start at the UNICON Main Menu and make the following selections:**

- ↳ **Manage Global Objects**

- ↳ **Manage Users**

- ↳ **All Entries**

The utility displays the user list described in “User List” on page 141.

2. **Press <Insert>.**

The utility displays a menu from which you can choose whether to create a NetWare account, a UNIX account, or both accounts and the mapping between them.

3. **Select an option.**

If you are creating a UNIX user only, the utility prompts for the new user’s name. Otherwise, the utility displays a list of available user objects and the process continues with Step 5.

4. **If you are creating a new UNIX user, type the new user’s name and press <Enter>.**

The utility displays the UNIX User Information form described in “UNIX User Information Form” on page 142 and the process continues with Step 6.

5. **Select a user object from the list or create a new user by pressing <Insert>. If you create a new user, be sure to select the new user object before you continue.**

If you are creating a NetWare user only, continue with the response to Step 6. If you are creating a UNIX user account as well, the utility displays the UNIX User Information form described in “UNIX User Information Form” on page 142.

- 6. Fill in the information on the UNIX User Information form and press <Esc>.**

The utility prompts you to indicate whether a user template exists. If there is a user template, the utility uses default information from the template such as password restrictions. For information on user templates, refer to the documentation for NetWare 5.

- 7. Select Yes if the user template exists and you want the defaults assigned to the new user. Otherwise, select No.**

The utility prompts for the new user's password.

- 8. Type the new user's password and press <Enter>.**

The utility creates the user account(s) and displays the user list. The new user appears in the list. If you created both NetWare and UNIX accounts for the user, the two accounts are mapped and appear side by side in the list.

- 9. To return to the Main Menu, press <Esc> as many times as needed.**

The utility displays the Main Menu.

Converting UNIX Accounts to NetWare Accounts

This procedure allows you to convert one or more UNIX* user accounts to NetWare® accounts in a single operation.

Use this method when your user list includes many UNIX user accounts without corresponding NetWare accounts (for example, if you transferred the UNIX passwd file from another machine). If corresponding NetWare and UNIX accounts have different names, map the accounts individually (see "Mapping User Accounts" on page 156).

If any of the UNIX user accounts you select for conversion already exist as NetWare user accounts, the utility maps the existing accounts. Accounts that are already mapped cannot be converted.

A number of events occur when you convert UNIX user accounts to NetWare user accounts. See "Mapping User Accounts between NetWare and NFS" on page 29 for more information.

Note: You must convert all UNIX user accounts before you begin converting groups. If you convert UNIX groups to NetWare groups before you convert the user accounts, the NetWare groups will not contain any members.

Use this procedure to convert UNIX accounts:

- 1. Start at the UNICON Main Menu and make the following selections:**

- ↳ **Manage Global Objects**

- ↳ **Manage Users**

- ↳ **All Entries**

The utility displays the user list described in “User List” on page 141.

An asterisk next to a UNIX user account means there is a NetWare user account by the same name. The conversion process assumes that accounts with the same name belong to the same person.

- 2. Mark all UNIX user accounts using <Shift-F7> and unmark all NetWare accounts using <F5>.**

Because this process only converts UNIX accounts, you must unmark all NetWare accounts before you proceed. If you attempt to continue without unmarking the NetWare accounts, you will receive an error message.

- 3. To convert the accounts, press <Enter>.**

The utility prompts you to confirm the conversion.

- 4. Select Yes to confirm the conversion or No to cancel the conversion and redisplay the user list.**

The utility prompts you to indicate whether a user template exists. If there is a user template, the utility uses default information from the template such as password restrictions. For information on user templates, refer to the documentation on NetWare 5.

- 5. Select Yes if the user template exists and you want the defaults assigned to the new users. Otherwise, select No.**

The utility prompts you for passwords for the NetWare users.

6. **Type a single password for all users or a password for each user as you are prompted and press <Enter>.**

7. **Retype the password and press <Enter>.**

The utility continues to convert UNIX users until all marked users have been converted.

8. **Press <Esc> to continue.**

The utility displays the user list. The NetWare user accounts and the UNIX user accounts are mapped and appear side by side in the list.

9. **To return to the Main Menu, press <Esc> as many times as needed.**

The utility displays the Main Menu.

Changing Information about Users

The procedures in this section provide instructions for modifying existing user information in various ways. You can combine these procedures.

Note: These procedures assume you do not want to use any of the available filtering options. Therefore, the procedures instruct you to select All Entries from the filtering menu to display the user list. To use one of the filtering options instead, select the filtering option rather than All Entries. For more information on using the filtering options, see “Filtering User and Group Information” on page 139.

Renaming a User

Use this procedure to change a user name:

1. **Start at the UNICON Main Menu and make the following selections:**

↳ **Manage Global Objects**

↳ **Manage Users**

↳ **All Entries**

The utility displays the user list described in “User List” on page 141.

2. **To rename a user's account, highlight the account and press <F3>.**

If the user does not have a mapped account, proceed to Step 4. Otherwise, the utility displays a menu from which you can choose whether to rename the NetWare user account or the UNIX user account.

3. **Select either NetWare user or UNIX user.**

The utility prompts for the new name.

4. **Type the new name and press <Enter>.**

The utility displays the user list, which reflects the name change.

5. **To return to the Main Menu, press <Esc> as many times as needed.**

The utility displays the Main Menu.

Adding a User to a Group

Note: You can also add a user to a group by editing the group list, described in "Adding a User to a Group" on page 153.

Use this procedure to add a user to a group:

1. **Start at the UNICON Main Menu and make the following selections:**

- ↳ **Manage Global Objects**
- ↳ **Manage Users**
- ↳ **All Entries**

The utility displays the user list described in "User List" on page 141.

2. **Select a user account.**

The utility displays the User Information form described in "User Information Form" on page 143.

3. **Select the Group Membership field.**

The utility displays a list of the groups to which the user belongs.

4. Press <Insert>.

The utility displays a menu from which you can choose whether to add the user to a NetWare group, a UNIX group, or both groups.

5. Select the appropriate option.

The utility displays a list of available groups.

6. Mark all groups to which to add the user by using <F5>. Then press <Enter>.

The utility displays an informational message as it adds the user to all selected groups.

7. To display the amended list of groups, press <Esc>.

The utility displays the new groups in the group list.

8. To exit the group list, press <Esc>.

The utility redisplay the User Information form.

9. To return to the Main Menu, press <Esc> as many times as needed.

The utility displays the Main Menu.

Deleting a User from a Group

Note: You can also delete a user from a group by editing the group list, described in “Deleting a User from a Group” on page 154.

Use this procedure to delete a user from a group:

1. Start at the UNICON Main Menu and make the following selections:

↳ **Manage Global Objects**

↳ **Manage Users**

↳ **All Entries**

The utility displays the user list described in “User List” on page 141.

2. Select a user account.

The utility displays the User Information form described in “User Information Form” on page 143.

3. Select the Group Membership field.

The utility displays a list of the groups to which the user belongs.

4. Mark all groups from which you want to delete the user by using <F5>. Then press <Delete>.

The utility displays a menu from which you can choose whether to delete the user from a NetWare group, a UNIX group, or both groups.

5. Select the appropriate option.

The utility displays an informational message as it deletes the user from all selected groups.

6. To display the amended list of groups, press <Esc>.

The utility displays the group list.

7. To exit the group list, press <Esc>.

The utility redisplay the User Information form.

8. To return to the Main Menu, press <Esc> as many times as needed.

The utility displays the Main Menu.

Mapping User Accounts

Once you have established both NetWare® and UNIX* user accounts for the same person, you must create a correspondence between the accounts so that the system registers both accounts as belonging to the same person. This process is called *mapping*. Mapping is done automatically when

- ◆ You create both the NetWare user account and the UNIX user account at the same time (for example, using the Create Both Users option from the user list)
- ◆ You convert multiple UNIX user accounts to NetWare accounts

Otherwise, use the following procedure to map a new user account to an existing account. For more information about mapping users, refer to “Mapping User Accounts between NetWare and NFS” on page 29.

Note: Even if you are using another NFS product that maintains a file containing NetWare-to-UNIX mappings, you must still map the user accounts as described in the following sections. If you do not, NFS clients may not be able to access file sharing or printing services.

Use this procedure to map user accounts:

1. **Start at the UNICON Main Menu and make the following selections:**

- ⇒ **Manage Global Objects**
- ⇒ **Manage Users**
- ⇒ **All Entries**

The utility displays the user list described in “User List” on page 141.

2. **Select the NetWare user account you want to map.**

The utility displays the User Information form described in “User Information Form” on page 143.

3. **Select the UNIX Username field.**

The utility displays a list of UNIX user accounts.

4. Select the corresponding UNIX user account.

The utility displays the selected UNIX user account in the UNIX Username field.

5. To map the accounts, press <Esc>.

The utility maps the selected accounts and displays them side by side on the user list.

6. To return to the Main Menu, press <Esc> as many times as needed.

The utility displays the Main Menu.

Deleting User Accounts

Note: This procedure deletes the UNIX* user information stored in the PASSWD file or in the equivalent NIS database. It does not delete the UNIX user account from the UNIX system unless you are using the NetWare® NIS server to manage your UNIX machines.

Use this procedure to delete a user account.

1. Start at the UNICON Main Menu and make the following selections:

- ↳ **Manage Global Objects**
- ↳ **Manage Users**
- ↳ **All Entries**

The utility displays the user list described in “User List” on page 141.

2. Highlight all user accounts you want to delete and press <Delete>.

If you mark a user who has both a NetWare and a UNIX account, the utility displays a menu. You can choose whether to delete the NetWare user account, the UNIX user account, the mapping between the user accounts, or both the user accounts and the mapping.

- 3. If prompted, select the appropriate deletion option from the menu.**

The utility prompts you to confirm the action.

- 4. Select Yes to perform the operation or No to cancel the operation.**

If you select Yes, the utility deletes the account and the process continues with Step 6. If you are deleting a NetWare user (identified with .cn=), the utility prompts you to indicate whether to delete the user from the NDS™ tree as well. If you respond No, the user's NFS account is removed, but the user remains in the NDS database.

- 5. If prompted, select Yes to delete the user from the NDS tree or No to remove the NFS account only.**

The utility displays an informational message as it deletes each specified entry.

- 6. To redisplay the user list, press <Esc>.**

The utility displays the user list. The entries are removed from the list or displayed as unmapped accounts.

- 7. To return to the Main Menu, press <Esc> as many times as needed.**

The utility displays the Main Menu.

Using the Group Management Screens

Manage groups using the following UNICON screens:

- ◆ Group list
- ◆ Group Information form
- ◆ User membership list

If you need information about a specific field on one of these screens, position the cursor in the field and press <F1>.

Group List

The group list displays all groups in the current database. All group configuration procedures begin on this screen.

Displaying the Group List

1. To display the group list, start at the UNICON Main Menu and make the following selections:
 - ↳ Manage Global Objects
 - ↳ Manage Groups
 - ↳ All Entries

NetWare Group	UNIX Group	
-----	neugroup	x
engstaff	engstaff	
everyone	-----	
mrketstaff	mrketstaff	
-----	neugroup	x
nfs_gateway_manager	-----	
nfs_host_manager	-----	
nfs_nfscon_manager	-----	
nfs_services_manager	-----	
nfs_user_group_manager	-----	
srengstaff	srengstaff	
srmrketstaff	srmrketstaff	

2. Complete procedure and exit.

Understanding the Group List

The left column lists NetWare® groups. The right column lists UNIX* groups.

Groups that appear side by side are mapped. A dashed line next to a group means there is no corresponding mapped group. An asterisk to the right of both groups means that a UNIX group and a NetWare group have the same name but are not mapped.

Group Information Form

The Group Information form displays information for a single group. Use this form to create a group, change the information about the group, or map two groups.

Displaying the Group Information Form

To display the Group Information form,

1. **Start at the UNICON Main Menu and make the following selections:**
 - ↳ **Manage Global Objects**
 - ↳ **Manage Groups**
 - ↳ **All Entries**

The utility displays the group list described in “Group List” on page 159.

2. **Select a group.**

The utility displays the Group Information form.

Group Information			
NetWare Groupname:	ENGSTAFF	GID:	889
UNIX Groupname:	engstaff		
User Membership:	<see list>		

Understanding the Group Information form

This form contains the following fields:

NetWare Groupname—the NetWare name for the group. If no groupname is assigned, select this field to display a list of available NetWare groups. You can use this field to map a UNIX group to a NetWare group.

GID—the group's GID number. The GID number identifies what group is associated with UNIX files a user creates. Valid GID numbers are integers between 0 and 65,535. You can modify the GID by typing a new GID.

UNIX Groupname—the UNIX name for the group. If no groupname is assigned, select this field to display a list of available UNIX groups. You can use this field to map a NetWare group to a UNIX group.

User Membership—the users who are members of the group. Select this field to display a list of users who are members of the specified group. (This list is described in the next section.) You can add or delete group members using <Insert> and <Delete>.

User Membership List

The user membership list displays the users who are members of a group. Use this form to modify the membership of a group.

Displaying the User Membership List

To display the user membership list,

1. **Start at the UNICON Main Menu and make the following selections:**

 ↳ **Manage Global Objects**

 ↳ **Manage Groups**

 ↳ **All Entries**

The utility displays the group list described in “Group List” on page 159.

2. **Select a group.**

The utility displays the Group Information form described in “Group Information Form” on page 160.

3. **Select the User Membership field.**

The utility displays the user membership list.

NetWare User	UNIX User
bdover	bdover
nbrown	nbrown
-----	msuser
<<msuser2>>	msuser2

Understanding the User Membership List

The left column lists NetWare® members. The right column lists UNIX* members.

Accounts that appear side by side are mapped. A dashed line next to an account means there is no corresponding mapped account. Double brackets around a username mean there is a corresponding username, but that user is not a member of the group.

You can add to or delete users from the group by using <Insert> or <Delete>.

Creating Groups

To allow groups to access remote file systems and use bidirectional printing, you must create corresponding UNIX* and NetWare® groups on the NetWare server.

The information you need to create these groups is included in the “Group Information Worksheet” on page 68.

Hint: Identifying a new NetWare group with the same name as the UNIX group simplifies the task of mapping NetWare and UNIX groups.

Choose one of the following methods to create groups:

- ◆ Create a single group. This method allows you to create each group individually. You can create the NetWare group, the UNIX group, and the mapping between the groups at the same time. You will usually use this method after the initial configuration is complete.
- ◆ Convert UNIX groups. This method allows you to create multiple groups by converting existing UNIX groups to NetWare groups. You will usually use this method during the initial configuration.

Creating a Single Group

Note: This procedure creates the UNIX group information stored in the GROUP file or in the equivalent NIS database. You must also create the groups on the UNIX system unless you are using the NetWare NIS server to manage your UNIX machines and the groups already exist.

Use this procedure to create a single group:

1. **Start at the UNICON Main Menu and make the following selections:**

- ↳ **Manage Global Objects**

- ↳ **Manage Groups**

- ↳ **All Entries**

The utility displays the group list described in “Group List” on page 159.

2. **Press <Insert>.**

The utility displays a menu from which you can choose whether to create a NetWare group, a UNIX group, or both groups and the mapping between them.

3. **Select an option.**

If you are creating a UNIX group only, the utility prompts for the new group’s name. Otherwise, the utility displays a list of available group objects and the process continues with Step 5.

4. **If you are creating a new UNIX group, type the new group’s name and press <Enter>.**

The utility displays the Group Information form described in “Group Information Form” on page 160 and the process continues with Step 6.

5. **Select a group from the list or create a new group by pressing <Insert>. If you create a new group, be sure to select the new group before you continue.**

If you are creating a NetWare group only, continue with Step 7. If you are also creating a UNIX group, the utility displays the Group Information form described in “Group Information Form” on page 160.

6. **Fill in the information on the Group Information form and press <Esc>.**

The utility creates the groups and displays the group list. The new groups appear on the list. If you created both NetWare and UNIX groups, the groups are mapped and appear side by side.

7. **Press <Esc> as many times as needed to return to the Main Menu.**

The utility displays the Main Menu.

Converting UNIX Groups to NetWare Groups

This procedure allows you to convert one or more UNIX groups to NetWare groups in a single operation.

Use this method when your group list includes many UNIX groups without corresponding NetWare groups (for example, if you transferred the UNIX group file from another machine). If corresponding NetWare and UNIX groups have different names, map the groups individually (see “Mapping Groups” on page 170).

If any of the UNIX groups you select for conversion already exist as NetWare groups, the utility maps the existing groups. Groups that are already mapped cannot be converted.

A number of events occur when you convert UNIX groups to NetWare groups. See “Mapping Groups between NetWare and NFS” on page 30.

Note: You must convert all UNIX user accounts before you begin converting groups. If you convert UNIX groups to NetWare groups before you convert the user accounts, the NetWare groups will not contain any members.

Use this procedure to convert UNIX groups:

1. **Start at the UNICON Main Menu and make the following selections:**
 - ↳ **Manage Global Objects**
 - ↳ **Manage Groups**
 - ↳ **All Entries**

The utility displays the group list described in “Group List” on page 159.

2. **Mark all UNIX groups using <Shift-F7> and unmark all NetWare groups using <F5>.**

Because this process only converts UNIX groups, you must unmark all NetWare groups before you proceed. If you continue without unmarking the NetWare groups, you will receive an error message.

3. **To convert the groups, press <Enter>.**

The utility prompts you to confirm the conversion.

4. **Select Yes to confirm the conversion or No to cancel the conversion and redisplay the group list.**

If you select Yes, the utility displays a confirmation message while it converts the UNIX groups to NetWare groups.

5. **To display the group list, press <Esc>.**

The utility displays the group list. The NetWare groups and the UNIX groups are mapped and appear side by side in the list.

6. **To return to the Main Menu, press <Esc> as many times as needed.**

The utility displays the Main Menu.

Changing Information about Groups

The procedures in this section provide instructions for modifying group information in various ways. You can combine these procedures.

Important: These procedures assume you do not want to use any of the available filtering options. Therefore, the procedures instruct you to select All Entries from the filtering menu to display the group list. To use one of the filtering options instead, select the filtering option rather than All Entries. For more information on using the filtering options, see “Filtering User and Group Information” on page 139.

Renaming a Group

Use this procedure to change a group name:

1. **Start at the UNICON Main Menu and make the following selections:**

- ↳ **Manage Global Objects**
- ↳ **Manage Groups**
- ↳ **All Entries**

The utility displays the group list described in “Group List” on page 159.

2. **To change a group’s name, highlight the name and press <F3>.**

If the group is not mapped, proceed to Step 4. If the group is mapped, you can choose to rename the NetWare group or the UNIX group.

3. **Select NetWare group or UNIX group.**

The utility prompts for the new name.

4. **Type the group’s new name and press <Enter>.**

The utility displays the group list, which reflects the name change.

5. **To return to the Main Menu, press <Esc> as many times as needed.**

The utility displays the Main Menu.

Adding a User to a Group

Use this procedure to add a user to a group:

1. **Start at the UNICON Main Menu and make the following selections:**

- ↳ **Manage Global Objects**

- ↳ **Manage Groups**

- ↳ **All Entries**

The utility displays the group list described in “Group List” on page 159.

2. **Select a group.**

The utility displays the Group Information form described in “Group Information Form” on page 160.

3. **Select the User Membership field.**

The utility displays the user membership list described in “User Membership List” on page 162.

4. **Press <Insert>.**

The utility displays a menu from which you can choose whether to add the user to the NetWare Group, the UNIX group, or both groups.

5. **Select the appropriate option.**

The utility displays a list of mapped users.

6. **Mark all users to add by using <F5>. Then press <Enter>.**

The utility displays an informational message as the users are added to the group.

7. **To display the amended list of users, press <Esc>.**

The utility displays the user membership list. The list includes the new group members.

8. **To return to the Main Menu, press <Esc> as many times as needed.**

The utility displays the Main Menu.

Deleting a User From a Group

Use this procedure to delete a user from a group.

1. **Start at the UNICON Main Menu and make the following selections:**

↳ **Manage Global Objects**

↳ **Manage Groups**

↳ **All Entries**

The utility displays the group list described in “Group List” on page 159.

2. **Select a group.**

The utility displays the Group Information form described in “Group Information Form” on page 160.

3. **Select the User Membership field.**

The utility displays the user membership list described in “User Membership List” on page 162.

4. **Mark all users to delete using <F5>. Then press <Delete>.**

The utility displays a menu from which you can choose whether to delete the user from the NetWare Group, the UNIX group, or both groups.

5. **Select the appropriate option.**

The utility displays an informational message as the users are deleted from the group.

6. **To display the amended list of users, press <Esc>.**

The utility displays the user membership list. The specified users have been deleted from the list.

7. **To return to the Main Menu, press <Esc> as many times as needed.**

The utility displays the Main Menu.

Mapping Groups

Once you have established both NetWare® and UNIX* groups, you must create a correspondence between the groups. This process is called *mapping*. Mapping is done automatically when

- ◆ You create both the NetWare group and the UNIX group at the same time (for example, using the Create Both Groups option from the group list)
- ◆ You convert multiple UNIX groups to NetWare groups

Otherwise, use the following procedure to map a new group to an existing group. For more information about mapping groups, see “Mapping Groups between NetWare and NFS” on page 30.

Use this procedure to map groups:

1. **Start at the UNICON Main Menu and make the following selections:**

- ↳ **Manage Global Objects**
 - ↳ **Manage Groups**
 - ↳ **All Entries**

The utility displays the group list described in “Group List” on page 159.

2. **Select the NetWare group you want to map.**

The utility displays the Group Information form described in “Group Information Form” on page 160.

3. **Select the UNIX Groupname field.**

The utility displays a list of UNIX groups.

4. Select the corresponding UNIX group.

The utility displays the selected groupname in the UNIX Groupname field.

5. To map the accounts, press <Esc>.

The utility maps the selected groups and displays them side by side on the group list.

6. To return to the Main Menu, press <Esc> as many times as needed.

The utility displays the Main Menu.

Deleting a Group

Note: This procedure deletes the UNIX group information stored in the GROUP file or in the equivalent NIS database. It does not delete the UNIX group from the UNIX system unless you are using the NetWare NIS server to manage your UNIX machines.

Use this procedure to delete a group:

1. Start at the UNICON Main Menu and make the following selections:

- ↳ **Manage Global Objects**
- ↳ **Manage Groups**
- ↳ **All Entries**

The utility displays the group list described in “Group List” on page 159.

2. Highlight the group you want to remove and press <Delete>.

The utility displays a menu from which you can choose whether to delete the NetWare® Group, the UNIX* group, the mapping between the groups, or both the groups and the mapping between them.

3. Select the appropriate deletion option from the menu.

The utility prompts you to confirm the action.

4. Select Yes to delete the group or No to cancel the operation.

If you select Yes, the utility deletes the group and the process continues with Step 6. If you are deleting a NetWare group that is imported from another OU, the utility prompts you to indicate whether to delete the group from the NDS™ tree as well.

5. If prompted, select Yes to delete the group from the NDS tree or No to if you want the group to remain in the NDS tree.

The utility displays an informational message as it deletes each specified entry.

6. To redisplay the group list, press <Esc>.

The utility displays the group list.

7. To return to the Main Menu, press <Esc> as many times as needed.

The utility displays the Main Menu.

Managing Print Services

This section describes how to set up and manage the bidirectional print services. You should already be familiar with how the print services operate. If you are not familiar with print service operations, see “Print Services” on page 31.

This section discusses the following topics:

- ◆ “Managing the Common Print Spool Directory” on page 173
- ◆ “Managing NetWare-to-UNIX Printing” on page 175
- ◆ “Managing UNIX-to-NetWare Printing” on page 187

Managing the Common Print Spool Directory

Both print services spool print jobs to a common directory. Manage the directory using the UNICON Print Spool Directory Form.

If you need information about a specific field on this form, position the cursor in the field and press <F1>.

Using the Print Spool Directory Form

The Print Spool Directory form specifies the location of the print spool directory.

Warning: If you attempt to change the print spool directory while print jobs are being processed, the print jobs will be lost. After changing the spool directory, you must stop and restart the print services for the change to take effect.

Displaying the Print Spool Directory Form

1. To display the Print Spool Directory form, start at the UNICON Main Menu and make the following selections:

- Manage Services
- Print Services
- Set Up Print Spool Directory

Print Spool Directory	
Volume:	SYS:
Directory:	/ETC/LPDSPool

2. Complete procedure and exit.

Understanding the Print Spool Directory Form

This form contains the following fields:

Volume—the volume on which the spool directory resides. Selecting this field displays a list of the volumes from which you can choose. The default volume is SYS:.

Directory—the path to the directory. The default path is ETC/LPDSPOOL.

Moving the Print Spool Directory

Use the following procedure to specify a new location for the print spool directory. The default location is SYS:ETC\LPDSPOOL.

- 1. Stop the print spool directory.**

If you attempt to move the print spool directory while print jobs are being processed, the print jobs will be lost.

- 2. Start at the UNICON Main Menu and make the following selections:**

- ↳ **Manage Services**

- ↳ **Print Services**

- ↳ **Set Up Print Spool Directory**

The utility displays the Print Spool Directory form described in “Using the Print Spool Directory Form” on page 173.

- 3. Enter a different volume or directory path or both and press <Esc>.**

The utility displays a confirmation box.

- 4. Select Yes to save your changes or No to cancel the operation.**

- 5. To return to the Main Menu, press <Esc> as many times as needed.**

The utility displays the Main Menu.

6. Stop and restart the print services as described in “Starting and Stopping Services” on page 117.

Managing NetWare-to-UNIX Printing

This section describes how to set up and manage the NetWare®-to-UNIX* print service.

Using the NetWare-to-UNIX Print Management Screens

Manage the NetWare-to-UNIX print service using the following UNICON screens:

- ◆ Default Print Server form
- ◆ UNIX Printer list
- ◆ UNIX Printer Configuration form
- ◆ Default User Account form

If you need information about a specific field on one of these screens, position the cursor in the field and press <F1>.

Default Print Server Form

The Default Print Server form identifies the default print server for the NetWare-to-UNIX print service. Use this form to select a server to be the default print server.

Important: You must select a default print server before you can configure other NetWare-to-UNIX print components.

Displaying the Default Print Server Form

1. To display the Default Print server form, start at the UNICON Main Menu and make the following selections:

- ↳ Manage Services
 - ↳ Print Services
 - ↳ Manage NetWare-to-UNIX Printing
 - ↳ Select Default Print Server

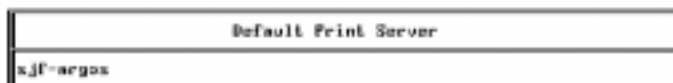

The image shows a screenshot of a form titled "Default Print Server". The form has a single text input field containing the value "sjf-argos".

2. Complete procedure and exit.

Understanding the Default Print Server Form

This form contains the following field:

Default Print Server—the name of the default print server used for NetWare-to-UNIX printing. Select this field to display a list of available print servers. You can also use the browser to create a new print server in any OU in the NDS™ tree. For more information on using the browser, see “Using the Object Browser” on page 115.

UNIX Printer Information List

The UNIX Printer Information list displays a list of NDS UNIX printer objects configured to accept jobs from a NetWare queue associated with the default print server. All UNIX printer configuration procedures begin with this list.

Displaying the UNIX Printer Information List

1. To display the UNIX Printer Information list, start at the UNICON Main Menu and make the following selections:

- ↳ Manage Services
 - ↳ Print Services
 - ↳ Manage NetWare-to-UNIX Printing
 - ↳ Configure UNIX Printers

UNIX Printer Information	
Printer Name	NetWare Queues Served
neuunixprinter	neuqueue, neuqueue2,

2. Complete procedure and exit.

Understanding the UNIX Printer Information List

The left column lists the NetWare NDS object name for the UNIX printer. The right column lists the names of the NetWare queues serviced by the printer. If this column reads <not configured>, select the printer and fill in the UNIX Printer Configuration form before using the printer for NetWare-to-UNIX printing.

UNIX Printer Configuration Form

The UNIX Printer Configuration form displays configuration information about a printer. Use this form to view or modify the information. You also use this form to configure a new UNIX printer.

Displaying the UNIX Printer Configuration Form

To display the UNIX Printer Configuration form,

1. **Start at the UNICON Main Menu and make the following selections:**

- ↳ **Manage Services**
- ↳ **Print Services**
- ↳ **Manage NetWare-to-UNIX Printing**
- ↳ **Configure UNIX Printers**

The utility displays the UNIX Printer Information list.

2. **Select a printer from the list.**

The utility displays the UNIX Printer Configuration form.

UNIX Printer Configuration	
NDS Printer Name:	neuunixprinter
Print Server:	sjf-argos
Queues Serviced:	<see list>
UNIX Hostname:	juniper
UNIX Printer Name:	unixprinter

Understanding the UNIX Printer Configuration Form

The form contains the following fields:

NDS Printer Name—the NetWare NDS object name for the UNIX printer. This field is read-only.

Print Server field—the default print server used for NetWare-to-UNIX printing. This field is read-only.

Queues Serviced—the NetWare queues that can send print jobs to the UNIX printer. Select this field to display a list of these queues. You must specify at least one NetWare queue to configure the UNIX printer. You can press <Insert> to display a list of available NetWare queues, or you can use the browser to create a new queue in any OU in the NDS tree.

For more information on using the browser, see “Using the Object Browser” on page 115.

UNIX Hostname—the UNIX host attached to the printer. Select this field to display a list of available UNIX hosts.

UNIX Printer Name—the UNIX name for the printer.

Default User Account Form

The Default User Account form identifies a UNIX user account for the NetWare-to-UNIX print service to use by default. Use this form to select a UNIX account to be the default account.

Displaying the Default User Account Form

1. To display the Default User Account form, start at the UNICON Main Menu and make the following selections:
 - ↳ Manage Services
 - ↳ Print Services
 - ↳ Manage NetWare-to-UNIX Print Service
 - ↳ Assign Default User Account

Default User Account	
Default UNIX User Account:	newuser
Always Use the Default UNIX Account:	Yes

2. Complete procedure and exit.

Understanding the Default User Account Form

This form contains the following fields:

Default UNIX User Account—the username that identifies the default UNIX user account. Select this field to display a list of UNIX user accounts.

Always Use the Default UNIX Account—when to use the default UNIX account. Yes means that all users who use the NetWare-to-UNIX print service also use the default account. No means that the account is only used by NetWare users without mapped UNIX accounts. The default is No.

Configuring NetWare-to-UNIX Printing

The following steps are required to configure the NetWare-to-UNIX print service:

1. Identify the NetWare server as a known host as described in “Managing Host Information” on page 121 and “Managing Host Group Information” on page 133.
2. Authorize the NetWare server to access the UNIX host as described in “Authorizing the NetWare Server to Access the UNIX Host” on page 181.
3. Select a default print server as described in “Selecting a Default Print Server” on page 181.
4. Configure the printer object as described in “Configuring the UNIX Printer” on page 182.
5. Identify the default UNIX user account as described in “Identifying the Default UNIX User Account” on page 183 (optional).
6. Start the NetWare-to-UNIX print service as described in “Starting and Stopping Services” on page 117.

Important: You must also configure the appropriate global objects such as users, groups, and hosts before the print service can function.

Authorizing the NetWare Server to Access the UNIX Host

The remote UNIX host cannot accept print jobs from the NetWare-to-UNIX print service until you

- ◆ Identify the NetWare server running the NetWare-to-UNIX print service to the UNIX host. For more information, see “Identifying the NetWare Server as a Known Host” on page 122.
- ◆ Authorize the NetWare server to access the UNIX host.

When the UNIX host receives a print request from a client, it searches for the client name in an authorization file. Only clients listed in the file are authorized to send print jobs. If the NetWare server is not identified in this file, you cannot use the NetWare-to-UNIX print service.

Some implementations of UNIX use the `/etc/hosts.lpd` file as the authorization file, but other implementations of UNIX may use a different file. See “Administration Procedures” on page 323 or your UNIX system documentation for information about authorizing NetWare access.

Selecting a Default Print Server

Important: Select a default print server before configuring other NetWare-to-UNIX print components.

Use this procedure to select a default print server for NetWare-to-UNIX printing:

1. **Start at the UNICON Main Menu and make the following selections:**
 - ↳ **Manage Services**
 - ↳ **Print Services**
 - ↳ **Manage NetWare-to-UNIX Printing**
 - ↳ **Select Default Print Server**

The utility displays the Default Print Server form described in “Default Print Server Form” on page 175.

2. **To display a list of the available print servers, press <Enter>.**

The utility displays a list of the available print servers.

3. **Select a print server from the list, or create a new print server by pressing <Enter>. If you create a new print server, be sure to select the new print server before you continue.**

The utility displays a confirmation box.

4. **Select Yes to select the new print server or No to cancel the operation.**

If you select Yes, the utility displays the Default Print Server form.

5. **Press <Esc>.**

The utility displays the Manage NetWare-to-UNIX Printing menu.

6. **To return to the Main Menu, press <Esc> as many times as needed.**

The utility displays the Main Menu.

Configuring the UNIX Printer

Use the following procedure to configure a UNIX printer:

1. **Start at the UNICON Main Menu and make the following selections:**

↳ **Manage Services**

↳ **Print Services**

↳ **Manage NetWare-to-UNIX Printing**

↳ **Configure UNIX Printers**

The utility displays the UNIX Printer Information list described in “UNIX Printer Information List” on page 176.

2. **Press <Insert>.**

The utility displays a list of the available printers.

3. **Select a printer from the list or create a new printer by pressing <Enter>. If you create a new printer, be sure to select the new printer before you continue.**

The utility displays the UNIX Printer Information list. The new UNIX printer appears in the list. The right column reads <not configured>.

4. Select the printer.

The utility displays the UNIX Printer Configuration form described in “UNIX Printer Configuration Form” on page 177.

5. Fill in the entire form and press <Esc> to exit.

The utility displays a confirmation box.

6. Select Yes to save the configuration or No to cancel the operation.

If you select Yes, the utility configures the UNIX printer and displays the UNIX printer list.

7. To return to the Main Menu, press <Esc> as many times as needed.

The utility displays the Main Menu.

Identifying the Default UNIX User Account

Use the following procedure to identify a UNIX user account as the default account:

1. Start at the UNICON Main Menu and make the following selections:

↳ **Manage Services**

↳ **Print Services**

↳ **Manage NetWare-to-UNIX Printing**

↳ **Assign Default Account**

The utility displays the Default User Account form described in “Default User Account Form” on page 179.

2. Press <Enter> to display a list of UNIX user accounts and select an account from the list.

The utility displays the Default User Account form. The new default user account appears in the form.

- 3. To use this default account for all users printing to a UNIX printer, highlight the Always Use the Default UNIX Account field and select Yes.**

The utility displays the Default User Account form.

- 4. To exit the form, press <Esc>.**

The utility displays a confirmation box.

- 5. Select Yes to save your changes or No to cancel the operation.**

If you select Yes, the utility saves the changes and displays the Manage NetWare-to-UNIX Printing menu.

- 6. Press <Esc> as many times as needed to return to the Main Menu.**

The utility displays the Main Menu.

Modifying a UNIX Printer

Use this procedure to modify the configuration of a UNIX printer:

- 1. Start at the UNICON Main Menu and make the following selections:**

↳ **Manage Services**

↳ **Print Services**

↳ **Manage NetWare-to-UNIX Printing**

↳ **Configure UNIX Printers**

The utility displays the UNIX Printer Information list described in “UNIX Printer Information List” on page 176.

- 2. Select the printer you want to modify.**

The utility displays the UNIX Printer Configuration form described in “UNIX Printer Configuration Form” on page 177.

- 3. Modify the form as necessary and press <Esc> to exit.**

The utility displays a confirmation box.

4. **Select Yes to save your changes or No to cancel the operation.**

If you select Yes, the utility saves the changes and redisplay the UNIX Printer Information list.

5. **To return to the Main Menu, press <Esc> as many times as needed.**

The utility displays the Main Menu.

Deleting UNIX Printers

Note: This procedure removes the UNIX printer from the UNIX printer list only. It does not delete the UNIX printer from the NDS tree.

Use this procedure to delete a UNIX printer:

1. **Start at the UNICON Main Menu and make the following selections:**

- ↳ **Manage Services**

- ↳ **Print Services**

- ↳ **Manage NetWare-to-UNIX Printing**

- ↳ **Configure UNIX Printers**

The utility displays the UNIX Printer Information list described in “UNIX Printer Information List” on page 176.

2. **Highlight the printer you want to remove and press <Delete>.**

The utility displays a confirmation box.

3. **Select Yes to delete the printer or No to cancel the operation.**

If you select Yes, the utility deletes the printer and redisplay the UNIX Printer Information list.

4. **To return to the Main Menu, press <Esc> as many times as needed.**

The utility displays the Main Menu.

Using NPRINT

You can use the NetWare NPRINT command to pass options to the remote printer. You can also pass these options using the CAPTURE command and the PRINTCON utility's NAME field entry. (PRINTCON utility is provided only with NetWare 4.)

NPRINT uses the following syntax:

```
NPRINT path NAM=[option]
```

Replace *path* with the full path name for the file you want to print.

Replace *option* with one or more of the following flags:

- ◆ -1 *font* mounts the specified font on position 1.
- ◆ -2 *font* mounts the specified font on position 2.
- ◆ -3 *font* mounts the specified font on position 3.
- ◆ -4 *font* mounts the specified font on position 4.
- ◆ -t indicates that the file contains troff (cat phototypesetter) binary data.
- ◆ -n indicates that the file contains data from ditroff (device independent troff).
- ◆ -d indicates that the file contains data from tex (DVI format from Stanford).
- ◆ -g indicates that the file contains standard plot data.
- ◆ -v indicates that the file contains a raster image. The printer must support an appropriate imaging model such as PostScript in order to print the image.
- ◆ -c indicates that the file contains data produced by cif-plot.
- ◆ -f interprets the first character of each line as a standard FORTRAN carriage control character.

For example, you can enable the NetWare-to-UNIX print gateway to pass a raster image created on a DOS system to the remote printer using the following command:

```
NPRINT path NAM=-v
```

Managing UNIX-to-NetWare Printing

This section describes how to set up and manage the UNIX-to-NetWare print service.

Using the UNIX-to-NetWare Print Management Screens

Manage the UNIX-to-NetWare print service using the following UNICON screens:

- ◆ Exported NetWare Queues list
- ◆ Exported Queue Configuration form
- ◆ Print Job Configurations list
- ◆ Print Job Configuration form
- ◆ Default Queue Configuration form
- ◆ Default User Account form

If you need information about a specific field on one of these screens, position the cursor in the field and press <F1>.

Exported NetWare Queues List

The Exported NetWare Queues list displays the NetWare queues that have been exported and are accessible by UNIX print jobs.

1. To display this list, start at the UNICON Main Menu and make the following selections:

- ↳ Manage Services
 - ↳ Print Services
 - ↳ Manage UNIX-to-NetWare Printing
 - ↳ Export NetWare Queues

Exported NetWare Queues
queue34

2. Complete procedure and exit.

Exported Queue Configuration Form

The Exported Queue Configuration form displays information about an exported NetWare queue. Use this form to view or modify the information about a queue. You also use this form to export a queue.

Displaying the Exported Queue Configuration Form

To display the Exported Queue Configuration form,

1. **Start at the UNICON Main Menu and make the following selections:**

- ↳ **Manage Services**
- ↳ **Print Services**
- ↳ **Manage UNIX-to-NetWare Printing**
- ↳ **Export NetWare Queues**

The utility displays the Exported NetWare Queues list described in “Exported NetWare Queues List” on page 188.

2. **Select a queue.**

The utility displays the Exported Queue Configuration form.

Exported Queue Configuration	
Exported NetWare Queue:	queue34
Filter:	LinePrinter
Print Job Configurations:	
Trust All Hosts and Hostgroups:	No
Trusted Hosts and Hostgroups:	<see list>

Understanding the Exported Queue Configuration Form

This form contains the following fields:

Exported NetWare Queue—the name of the queue. This field is read-only.

Filter—the type of filter applied to jobs directed to this queue. Select this field to display a list of available filter types. Choose from the following types:

- ◆ **None.** Incoming print jobs are assumed to be correctly formatted for the printer. No preprocessing is applied.

- ◆ **Line Printer.** Print jobs are formatted for line printers or printers emulating line printers. This filter converts UNIX text to DOS format.
- ◆ **PostScript.** Print jobs are a mixture of ASCII files and PostScript jobs. ASCII print jobs are converted to PostScript before being sent to the printer. PostScript jobs are sent without alteration.

Print Job Configuration— the configuration for all print jobs spooled to this queue. Select this field to display a list of available configurations. Highlight a configuration and press <Tab> to display the print job configuration profile.

Note: You can override this print job configuration by specifying the `lpr -J` option as described in “Using the `lpr` Command” on page 206.

Trust All Hosts and Hostgroups—whether all UNIX hosts are authorized to send print jobs to the exported NetWare queue. `Yes` authorizes all UNIX hosts to send print jobs. `No` authorizes only the UNIX hosts and hostgroups listed in the `Trusted Hosts and Hostgroups` field.

Trusted Hosts and Hostgroups—the UNIX hosts and hostgroups that can access the queue. Select this field to display a list of the `Trusted Hosts and Hostgroups` for the queue. Press <Insert> when the list is displayed for a list of available hosts and hostgroups.

Print Job Configurations List

The Print Job Configurations list displays all available print job configurations.

1. To display this list, start at the UNICON Main Menu and make the following selections:

- Manage Services
 - Print Services
 - Manage UNIX-to-NetWare Printing
 - Set Up Print Job Configuration

Print Job Configurations
neuprintcon

2. Complete procedure and exit.

Print Job Configuration Form

The Print Job Configuration form displays the definition for a single configuration. Use this form to view or modify configuration information. You also use this form to create a new configuration.

Displaying the Print Job Configuration Form

1. To display the Print Job Configuration form, start at the UNICON Main Menu and make the following selections:

- ↳ Manage Services
 - ↳ Print Services
 - ↳ Manage UNIX-to-NetWare Printing
 - ↳ Set Up Print Job Configuration

Print Job Configuration	
Name:	seuprintcon
Number of copies:	12
File contents:	Text
Tab size:	8
Form feed:	No
Notify when done:	No
Queue:	seuqueue
Device:	
Node:	
Form name:	
Print banner:	No
Name:	
Banner name:	

2. Complete procedure and exit.

Understanding the Print Job Configuration Form

This form contains the following fields:

Name—the name of the configuration. This field is read-only.

Number of copies—the number of copies to print. The default is 1.

File contents—the contents of the print file. Select this field to display a list of available content types. The default is Text.

Tab size—the tab size in the print job. This value only applies when the File Contents field is set to Text.

Form feed—whether form feed is on or off. Yes sends a form feed after each print job. The default is No.

Notify when done—whether notification is sent when the print job is finished. The default is No.

Queue—the queue receiving NetWare print jobs. Select this field to display a list of queues. This value only applies to NetWare printing. It is required if you want to use the print job configuration for NetWare printing as well as UNIX-to-NetWare printing.

Device—the printer device type. Select this field to display a list of available devices.

Mode—the device mode. Select this field to display a list of modes. This value only applies if you select a device type.

Form name—the form used for jobs sent to this exported queue. Select this field to display a list of form types.

Note: Create or delete print devices, modes, and forms using the NetWare PRINTDEF utility.

Print banner—whether to print a banner page. The default is No.

Name—the text that appears on the upper part of the banner page. You can specify up to 12 characters. The default is the username.

Banner name—the text that appears on the lower part of the banner page. You can specify up to 12 characters. The default is the print job name.

Default Queue Configuration Form

The Default Queue Configuration form displays the default configuration for exported NetWare queues. UNICON uses these values when you export a new queue. Use this form to create or modify the defaults. Use the Exported Queue Configuration form (described in “Exported Queue Configuration Form” on page 188) to modify the value for an individual queue.

Displaying the Default Queue Configuration Form

1. To display the Default Queue Configuration form, start at the UNICON Main Menu and make the following selections:

- ↳ Manage Services
 - ↳ Print Services
 - ↳ Manage UNIX-to-NetWare Printing
 - ↳ Set Default Exported Queue Configuration

Default Queue Configuration	
Filter:	LinePrinter
Print Job Configurations:	neuprintcon
Trust All Hosts and Hostgroups:	Yes
Trusted Hosts and Hostgroups:	

2. Complete procedure and exit.

Understanding the Default Queue Configuration Form

This form contains the following fields:

Filter—the type of filter applied to jobs directed to this queue. Select this field to display a list of filter types. Choose from the following types:

- ◆ None. Incoming print jobs are assumed to be correctly formatted for the printer. No preprocessing is applied.
- ◆ Line Printer. Print jobs are formatted for line printers or printers emulating line printers. This filter converts UNIX text to DOS format.
- ◆ PostScript. Print jobs are a mixture of ASCII files and PostScript jobs. ASCII print jobs are converted to PostScript before being sent to the printer. PostScript jobs are sent without alteration.

Print Job Configuration—the configuration for all print jobs spooled to this queue. Select this field to display a list of available configurations. Highlight a configuration and press <Tab> to display the print job configuration profile.

Trust All Hosts and Hostgroups—whether all UNIX hosts are authorized to send print jobs to the exported NetWare queue. Yes authorizes all UNIX hosts to send print jobs. No authorizes only the UNIX hosts and hostgroups listed in the Trusted Hosts and Hostgroups field.

Trusted Hosts and Hostgroups—the UNIX hosts and hostgroups that can access the queue. Select this field to display a list of the Trusted Hosts and Hostgroups for the queue. Press <Insert> when the list is displayed for a list of available hosts and hostgroups.

Default User Account Form

The Default User Account form identifies a NetWare user account for the UNIX-to-NetWare print service to use by default. Use this form to select a NetWare account to be the default account.

Displaying the Default User Account Form

1. To display the Default User Account form, start at the UNICON utility's Main Menu and make the following selections:
 - ↳ Manage Services
 - ↳ Print Services
 - ↳ Manage UNIX-to-NetWare Printing
 - ↳ Assign Default User Account

Default User Account	
Default NetWare User Account:	newuser
Always Use the Default NetWare Account:	Yes

2. Complete procedure and exit.

Understanding the Default User Account Form

This form contains the following fields:

Default NetWare User Account—the username that identifies the default NetWare user account. Select this field to display a list of NetWare user accounts.

Always Use the Default NetWare Account—when to use the default NetWare account. Yes means that all users who use the UNIX-to-NetWare print service also use the default account. No means that the account is used only by UNIX users without mapped NetWare accounts. The default is No.

Configuring UNIX-to-NetWare Printing

The following steps are required to configure the UNIX-to-NetWare printing service:

1. Identify the NetWare server as a known host as described in “Managing Host Information” on page 121 and “Managing Host Group Information” on page 133.
2. Authorize the UNIX host as described in “Authorizing the UNIX Host to Access the NetWare Queue” on page 197.
3. Set up print job configurations as described in “Setting Up Print Job Configurations” on page 198 (optional).
4. Define the default exported queue configuration as described in “Defining the Default Exported Queue Configuration” on page 199 (optional).
5. Export a NetWare queue as described in “Exporting a NetWare Queue” on page 200.
6. Assign a default NetWare user account as described in “Assigning a Default NetWare User Account” on page 201 (optional).
7. Start the UNIX-to-NetWare print service as described in “Starting and Stopping Services” on page 117.

Important: You must also configure the appropriate global objects such as users, groups, and hosts before the print service can function.

Authorizing the UNIX Host to Access the NetWare Queue

The remote UNIX host cannot send print jobs to a NetWare printer until you

- ◆ Identify the NetWare server running the UNIX-to-NetWare print service to the UNIX host. For more information, see “Identifying the NetWare Server as a Known Host” on page 122.
- ◆ Authorize the UNIX host to send print jobs to a NetWare queue.

Important: Only UNIX hosts that support the lpr protocol can use the UNIX-to-NetWare print service as described in this section. If you have a system that does not use the lpr protocol, see “Using the rsh Command” on page 207, which describes another way to send a print job to a NetWare print queue.

To authorize the UNIX host to send a print job to NetWare queue, include an entry in the `/etc/printcap` file that associates a UNIX print queue with the NetWare server and an exported NetWare print queue.

Although most UNIX systems use the `printcap` file to define printer entries, some implementations of UNIX use a different file. See your UNIX system’s documentation for more information about defining printers.

Enter the following line in `/etc/printcap`:

```
ap0 | printername:lp=output_device
      :rm=Netware_hostname:rp=Netware_print_queue
      :sd=UNIX_spool_directory
      :mx=number_of_megabytes
```

where:

- ◆ *printername* is the name of the printer.
- ◆ *output_device* identifies the output device. For a remote printer, omit this parameter.
- ◆ *NetWare_hostname* is the name of the NetWare server on which the UNIX-to-NetWare print service is running. This parameter is required.

- ◆ *NetWare_print_queue* is the name of the exported NetWare print queue. This parameter is required.
- ◆ *UNIX_spool_directory* identifies the UNIX spool directory for jobs that are sent to this printer. This parameter is required.
- ◆ *Number_of_megabytes* specifies the largest file that can be handled. If the parameter is omitted, a default value is used. The default value is 1000 * BUFSIZE; the BUFSIZE variable is defined in the /usr/include/stdio.h file. To override the default parameter, add `mxx=0` to the printcap entry; this disables the file size limitation.

Setting Up Print Job Configurations

Use this procedure to set up print job configurations.

1. **Start at the UNICON Main Menu and make the following selections:**

- ↳ **Manage Services**
 - ↳ **Print Services**
 - ↳ **Manage UNIX-to-NetWare Printing**
 - ↳ **Set Up Print Job Configurations**

The utility displays the Print Job Configurations list described in “Print Job Configurations List” on page 191.

2. **Press <Insert>.**

The utility prompts for the name of the new entry.

3. **Type the name of the new print job configuration and press <Enter>.**

The utility prompts for the name of the NetWare queue.

4. **Press <Enter> to display a list of available queues and select a queue from the list.**

The utility displays the Print Job Configuration form described in “Print Job Configuration Form” on page 191.

5. **Fill in the form and press <Esc> to exit.**

The utility displays a confirmation box.

6. **Select Yes to save your changes or No to cancel the operation.**

If you select Yes, the utility saves the changes and redisplay the Print Job Configurations list.

7. **To return to the Main Menu, press <Esc> as many times as needed.**

The utility displays the Main Menu.

Defining the Default Exported Queue Configuration

The values set in the default configuration are used each time a new NetWare queue is exported. Use this procedure to define the default exported queue configuration:

1. **Start at the UNICON Main Menu and make the following selections:**

↳ **Manage Services**

↳ **Print Services**

↳ **Manage UNIX-to-NetWare Printing**

↳ **Set Default Exported Queue Configuration**

The utility displays the Default Queue Configuration form described in “Default Queue Configuration Form” on page 193.

2. **Fill in the form and press <Esc> to exit.**

The utility displays a confirmation box.

3. **Select Yes to save your changes or No to cancel the operation.**

If you select Yes, the utility saves the changes and displays the Manage UNIX-to-NetWare Printing menu.

4. **To return to the Main Menu, press <Esc> as many times as needed.**

The utility displays the Main Menu.

Exporting a NetWare Queue

Use this procedure to export a NetWare queue:

1. **Start at the UNICON Main Menu and make the following selections:**

- ↳ **Manage Services**
- ↳ **Print Services**
- ↳ **Manage UNIX-to-NetWare Printing**
- ↳ **Export a NetWare Queue**

The utility displays the Exported NetWare Queue list described in “Exported NetWare Queues List” on page 188.

2. **Press <Insert>.**

The utility displays a list of available NetWare queues.

3. **Select a queue from the list or create a new queue by pressing <Insert>. If you create a new queue, be sure to select the new queue before you continue.**

The utility displays the Exported NetWare Queues list. By default, the new exported queue is configured with the default values specified in the Default Queue Configuration form.

4. **To modify the default configuration for the new exported queue, select the queue.**

The utility displays the Exported Queue Configuration form described in “Exported Queue Configuration Form” on page 188.

5. **Modify the form and press <Esc> to exit.**

The utility displays a confirmation box.

6. **Select Yes to save your changes or No to cancel the operation.**

If you select Yes, the utility saves the changes and redisplay the Exported NetWare Queues list.

7. **To return to the Main Menu, press <Esc> as many times as needed.**

The utility displays the Main Menu.

Assigning a Default NetWare User Account

Use this procedure to assign a default NetWare user account:

1. **Start at the UNICON Main Menu and make the following selections:**

- ↳ **Manage Services**
- ↳ **Print Services**
- ↳ **Manage UNIX-to-NetWare Printing**
- ↳ **Assign a Default User Account**

The utility displays the Default User Account form described in “Default User Account Form” on page 179.

2. **Press <Enter> and select an account from the list.**

The utility redisplay the Default User Account form. The selected account appears in the form.

3. **To use this default account for all users printing to a NetWare printer, highlight the Always Use the Default NetWare Account field and select Yes.**

The utility displays the Default User Account form.

4. **Press <Esc>.**

The utility displays a confirmation box.

5. **Select Yes to save your changes or No to cancel the operation.**

If you select Yes, the utility saves the changes and displays the Manage UNIX-to-NetWare Printing menu.

6. **Press <Esc> as many times as needed to return to the Main Menu.**

The utility displays the Main Menu.

Printing to Remote Print Queues

Use this procedure to send print jobs to remote print queues on both NetWare 3.x and NetWare 4/NetWare 5 servers.

The term *remote* in this context means the NetWare server is not running the UNIX-to-NetWare print service but does have a print queue to which to route UNIX print jobs. The print job request from the UNIX client is submitted to the local NetWare server running the UNIX-to-NetWare print service. This server then routes the job request to the remote server's print queue.

Printing to a Remote NetWare 4 /NetWare 5 Server in the Same NDS Tree

The UNIX-to-NetWare print service submits print jobs to the remote NetWare queue as the user named IP Service Handler. This username is created during installation for the purpose of submitting print jobs to remote NetWare 4 / NetWare 5 queues in your NDS™ tree.

Use this procedure to enable UNIX users to print to a queue located on a remote NetWare 4 / Netware 5 server in the same NDS tree.

- 1. Export the queue as described in “Exporting a NetWare Queue” on page 200.**
- 2. Use NetWare Administrator to make IP Service Handler a user of the remote print queue.**

Printing to a NetWare 3.x Server or a NetWare 4 / NetWare 5 Server in a Different NDS Tree

The UNIX-to-NetWare print service submits print jobs to remote bindery queues located on a NetWare 3.x server or a NetWare 4 / NetWare 5 server. A bindery user account exists for this purpose. This account should not have a password, because the print service cannot submit print jobs to the remote print queue if password validation is required.

This bindery user is specified in the SYS:ETC/NWPARAMS file by the parameter REMOTE_PLPD_USER. The default assigned username is GUEST.

Use this procedure to enable UNIX users to print to a remote print queue in a different NDS tree.

1. To change the default username for logging in to the remote server,
 - 1a. Open the SYS:ETC/NWPARAMS file with the EDIT utility.
 - 1b. Find the REMOTE_PLPD_USER parameter under the [PRINT_ADMIN] section heading.
 - 1c. Change the name assigned to the parameter.
2. Use the NetWare PCONSOLE utility to create a local NDS print queue that is linked to the remote print queue.

This utility is not provided with NetWare 5. You will have to use the NetWare Administrator utility for this purpose.

- 2a. From your current directory tree, choose the Print Queues option from the Available Options menu.
- 2b. Press <F6> and choose the destination NetWare server.
- 2c. Highlight the bindery print queue and press <Enter>.

The print queue now appears in your current tree with the same name as the destination bindery print queue.

3. Make sure the remote user is also a queue user of the remote print queue.
4. Export the local queue corresponding to the remote queue by performing the procedure in “Exporting a NetWare Queue” on page 200.

Modifying Exported Queue Entries

Use this procedure to modify an exported NetWare queue:

1. **Start at the UNICON Main Menu and make the following selections:**

- ↳ **Manage Services**
- ↳ **Print Services**
- ↳ **Manage UNIX-to-NetWare Printing**
- ↳ **Export a NetWare Queue**

The utility displays the Exported NetWare Queue list described in “Exported NetWare Queues List” on page 188.

2. **Select the exported queue.**

The utility displays the Exported Queue Configuration form described in “Exported Queue Configuration Form” on page 188.

3. **Modify the form and press <Esc> to exit.**

The utility displays a confirmation box.

4. **Select Yes to save your changes or No to cancel the operation.**

If you select Yes, the utility saves the changes and displays the Manage UNIX-to-NetWare Printing menu.

5. **To return to the Main Menu, press <Esc> as many times as needed.**

The utility displays the Main Menu.

Deleting Exported Queues

This procedure removes the queue from the list of exported queues. It does not remove the queue from the NDS tree.

Use this procedure to delete an exported NetWare queue:

1. **Start at the UNICON Main Menu and make the following selections:**

- ↳ **Manage Services**
- ↳ **Print Services**
- ↳ **Manage UNIX-to-NetWare Printing**
- ↳ **Export a NetWare Queue**

The utility displays the Exported NetWare Queues list described in “Exported NetWare Queues List” on page 188.

2. **Highlight the exported queue and press <Delete>.**

The utility displays a confirmation box.

3. **Select Yes to delete the exported queue or No to cancel the operation.**

If you select Yes, the utility deletes the exported queue and redisplay the Exported NetWare Queues list.

4. **Press <Esc> as many times as needed to return to the Main Menu.**

The utility displays the Main Menu.

Using UNIX Commands to Print

Users can also send print jobs from a UNIX host to the NetWare print queue using the `lpr` command, view the status of print jobs with the `lpq` command, and remove print jobs from the print queue with the `lprm` command.

Using the lpr Command

When users include flags with the `lpr` command, the NetWare print server handles the flags as follows:

- ◆ `-p` and `-f` emulate the UNIX `pr` and `fpr` (Fortran filter) commands.
- ◆ `-w` is used with the `-p` flag to specify page width.
- ◆ `-T` is used with the `-p` flag to specify the page title.
- ◆ `-M` sends mail to the user when the job is finished.
- ◆ `-J` can be used to specify a print configuration. The syntax is

```
lpr -J/printcon_name filename
```

`-J` can be used to print a particular job name on the banner page. The job name cannot exceed 12 characters. The syntax is

```
lpr -Jjobname filename
```

`-J` can also be used to print a job on a specific form. The syntax is

```
lpr -J/form=nnn filename
```

You can combine these uses as long the command does not exceed 99 characters in length. The syntax is

```
lpr -Jjobname/form=nnn filename
```

`-J` with `nff` suppresses the form feed at the end of a job. The syntax is

```
lpr -Jjobname/nff filename
```

`-J` with `nb` suppresses the banner page for an individual job. The syntax is

```
lpr -Jjobname/nb filename
```

You can also omit banner pages using the `-h` flag. The syntax is

```
lpr -h filename
```

You cannot use `-h` and `-J` flags together. If you want to suppress both the banner page and the form feed, use the following command:

```
lpr -J jobname/nb/nff
```

`-c`, `-d`, `-g`, `-m`, `-n`, `-num font`, `-t`, and `-v` are not supported.

Using the rsh Command

To submit a print job to a NetWare printer from a host that does not support the `lpr` protocol, transfer the job to a host that does support the `lpr` protocol. Use the `rsh` command to copy the file and execute the `lpr` command remotely.

Type the following command to print to a NetWare printer from a remote host that does not support the `lpr` protocol:

```
cat filename | rsh lprhost lpr -Pprintername
```

Slow Printing

The UNIX-to-NetWare print service maintains a file that tracks the number of job entries for each print queue. Once the number of entries in all files exceeds a preset value, the print service cleans up the files. Since cleanup requires processing overhead, you may be able to improve performance by increasing the number of entries allowed before cleanup is required.

To increase the number of entries, unload the print service (using the console `UNLOAD` command) and issue the console `LOAD PLPD` command. The syntax is

```
LOAD PLPD CLEANUP_JOB_ENTRIES=number
```

where *number* is the total number of job entries in all print queues. This number should be higher than the total number of print jobs being processed at any one time.

Reload the print service with the `LOAD` command.

Managing the Network Information Service (NIS)

This section describes how to manage the NetWare® UXPS server as a master NIS server. The section also provides instructions for using an NIS master server on another machine. You should already be familiar with the concept of NIS and understand how the UXPS server uses the information stored in NIS. If you are not familiar with these concepts, see “Name Services” on page 7.

You can set up NIS on the NetWare server running this product or use an existing NIS server. The installation program sets up the NIS service on the local NetWare server and starts that server as an NIS master by default.

Important: If you select a remote NIS master name server, you must manage all NIS database information on the master.

This section discusses the following topics:

- ◆ “Using the NetWare Server as the NIS Master” on page 208
- ◆ “Setting up an NIS Master Server” on page 222
- ◆ “Creating a Replica of the NIS Database” on page 225
- ◆ “Querying NIS Servers” on page 230

Using the NetWare Server as the NIS Master

This section describes how to manage an NIS master database on the NetWare® server.

Using the NIS Administration Screens

Manage the NetWare NIS master using the following UNICON screens:

- ◆ Maps in the master domain list
- ◆ Map File Information form

If you need information about a specific field on one of these screens, position the cursor in the field and press <F1>.

Maps in the Master Domain List

The maps in the master domain list displays all of the NIS maps in the master NIS domain. All your map management procedures begin with this list.

1. To display this list, start at the UNICON Main Menu and make the following selections:

- ↳ Manage Services
 - ↳ NIS
 - ↳ Administer NIS
 - ↳ Manage Master Database
 - ↳ Maintain Database



```
Maps in Domain Cargos.com?  
-----  
ethers.byaddr  
ethers.byname  
group.bygid  
group.byname  
hosts.byaddr  
hosts.byname  
id.bytoken  
netid.byname  
networks.byaddr  
networks.byname  
nfsgroup.bygid  
nfsgroup.byname  
nfshosts.byNISname  
nfshosts.byNISname  
nfsusers.byname  
nfsusers.byuid
```

2. Complete procedure and exit.

Map File Information Form

The Map File Information form displays information about a specific NIS map. Use this form to add or modify information about a map.

Displaying the Map File Information Form

Use this procedure to display the Map File Information form.

1. **Start at the UNICON Main Menu and make the following selections:**

- ↳ **Manage Services**
- ↳ **NIS**
- ↳ **Administer NIS**
- ↳ **Manage Master Database**
- ↳ **Maintain Database**

The utility displays the Maps in the Master Domain list described in “Maps in the Master Domain List” on page 209.

2. **Select a map from the list.**

The utility displays the Map File Information form.

Map File Information	
Map name:	group.bymano
Master Server:	juniper
Modification Date:	Thu Feb 24 11:00:29 1994
Text File:	SYS:\ETC\RESOURCE\NIS\GROUP
Action:	Do Nothing

Using the Map File Information Form

This form contains the following fields:

Map name—the name of the map.

Master Server—the name or IP address of the master NIS server.

Modification Date—the date the map was last modified.

Text File—the text file used to create the map. This text file is also used when you select the Save Map to Text file option. You can change the directory where you save a map, but you cannot change the filename for a standard NIS map.

Action—the action you want to perform on the specified map. Select this field to display the following list of actions:

- ◆ Do Nothing—the default action when you are viewing information about a map. This action does nothing with the information in the form.
- ◆ Save Map to Text File—saves the NIS map to the specified text file.
- ◆ Create Map from Text File—the default action when you are creating an NIS map. This action creates an NIS map from the specified text file.

Initializing the Master NIS Database

The master NIS database is usually initialized during installation. Initialize or reinitialize the database after installation when

- ◆ You originally chose to use an existing NIS master server during installation, but you now want the NetWare server to act as the master NIS server.
- ◆ The NetWare NIS database is corrupt.

Hint: Save the master NIS maps to text files periodically so that you always have a recent backup copy of the database. For more information on creating a backup copy of the database, see “Backing Up the Master NIS Database” on page 219.

Before you initialize the database, you should be familiar with the concept of creating databases. For more information on creating databases, see “Initializing NIS on the NetWare Master Server” on page 16.

Use this procedure to initialize the master NIS database on the NetWare server:

1. **Start at the UNICON Main Menu and make the following selections:**

- ↳ **Manage Services**

- ↳ **NIS**

- ↳ **Initialize Master NIS Maps**

The utility displays the name of the current NIS domain. By default, the name of the domain is the same as the name of the NetWare server.

2. **Accept the default domain name or type a new domain name and press <Esc> to continue.**

The utility prompts you to confirm the conversion of local files into database entries.

3. **Select Yes to convert the local files or No to cancel the operation.**

If you select Yes, the utility displays detailed status messages as the database is created and displays a message stating whether the conversion was successful.

If you select Yes and currently have an existing NIS database, the utility displays a message stating that you must remove the old database before you can create a new one. If you choose to remove the old database, the utility also removes all domains currently served.

4. **If prompted to remove an old database, press <Enter> to continue. Select Yes to remove the old database or No to cancel the operation.**

If you select Yes, the utility displays status messages as the old database is removed and the new database is created.

5. **Press <Esc> to continue.**

The utility redisplay the NIS menu.

6. To return to the Main Menu, press <Esc> as many times as needed.

The utility displays the Main Menu.

Managing NIS Maps

Use the following procedures to manage NIS maps. You should already be familiar with the concept of an NIS map. For more information on NIS maps, see “Information Stored in NIS” on page 11.

Creating an NIS Map

Creating an NIS map is a two step process:

1. First, create or obtain the NIS map text file
2. Then, convert the text file to an NIS map

Creating or Obtaining the Map Text File

You can use the UNICON Edit File option to create your own map text file. Or, if the file resides on another machine, you can obtain it using the Copy File option.

For more information on the format for NIS map text files, see “Custom NIS Maps” on page 12.

Converting a Text File to an NIS Map

Use this procedure to convert a map text file to an NIS map:

1. **Start at the UNICON Main Menu and make the following selections:**
 - ⇒ **Manage Services**
 - ⇒ **NIS**
 - ⇒ **Administer NIS**
 - ⇒ **Manage Master Database**
 - ⇒ **Maintain Database**

The utility displays the maps in the master domain list described in “Maps in the Master Domain List” on page 209.

2. **Press <Insert>.**

The utility prompts you for the name of the new map.

3. **Type the name of the new map and press <Enter>.**

The utility displays the Map File Information form described in “Map File Information Form” on page 209.

4. **Type the name of the text file to be converted to a map and press <Enter>.**

The utility highlights the Action field, which displays the Create Map from Text File option.

5. **Press <Esc> to exit the form and convert the text file.**

The utility displays a confirmation box.

6. **Select Yes to create the new map or No to cancel the operation.**

If you select Yes, the utility creates the new map and displays the maps in the master domain list. The new map appears in the list.

7. **To return to the Main Menu, press <Esc> as many times as needed.**

The utility displays the Main Menu.

Displaying Information About an NIS Map

Use this procedure to display information about an NIS map:

1. **Start at the UNICON Main Menu and make the following selections:**

⇒ **Manage Services**

⇒ **NIS**

⇒ **Administer NIS**

⇒ **Manage Master Database**

⇒ **Maintain Database**

The utility displays the maps in the master domain list described in “Maps in the Master Domain List” on page 209.

2. Select the map.

The utility displays the Map File Information form described in “Map File Information Form” on page 209.

3. To return to the Main Menu, press <Esc> as many times as needed.

The utility displays the Main Menu.

Saving an NIS Map to a Text File

Save an NIS map to a text file to

- ◆ Create a backup copy of an existing map.
- ◆ Transfer the text file to another NIS server. You can transfer an NIS map text file to another NIS server using the UNICON Copy File option.

Use this procedure to save an NIS map to a text file:

1. Start at the UNICON Main Menu and make the following selections:

- ↳ **Manage Services**
 - ↳ **NIS**
 - ↳ **Administer NIS**
 - ↳ **Manage Master Database**
 - ↳ **Maintain Database**

The utility displays the maps in the master domain list described in “Maps in the Master Domain List” on page 209.

2. Select the map.

The utility displays the Map File Information form described in “Map File Information Form” on page 209.

3. To save the map to a text file other than the file listed, enter the pathname for the new text file.

The new pathname appears in the Text File field.

4. Select the Action field.

The utility displays a list of available actions.

5. Select the Save Map to Text File option.

Save Map to Text File appears in the Action field.

6. To exit the form and save the map to a text file, press <Esc>.

The utility displays a confirmation box.

7. Select Yes to save the map to a text file or No to cancel the operation.

If you select Yes, the utility saves the map to the designated file and redisplay the Map Information form.

8. To return to the Main Menu, press <Esc> as many times as needed.

The utility displays the Main Menu.

Propagating Maps to Replica Servers

Propagate maps to replica servers to provide each server with a new copy of all maps in the master database. You may want to use this option when

- ◆ The database on one or more of the replica servers is corrupt.
- ◆ You have made significant changes to the master database.

Use this procedure to propagate the NIS maps to the replica servers:

1. Start at the UNICON Main Menu and make the following selections:

- ↳ **Manage Services**
 - ↳ **NIS**
 - ↳ **Administer NIS**
 - ↳ **Manage Master Database**
 - ↳ **Propagate to Replica Servers**

The utility displays a confirmation box.

2. **Select Yes to propagate the maps or No to cancel the operation.**

If you select Yes, the utility propagates the maps to the replica servers and displays the Manage Master Database menu.

3. **To return to the Main Menu, press <Esc> as many times as needed.**

The utility displays the Main Menu.

Deleting an NIS Map

You cannot delete most standard NIS maps. However, you can delete custom maps.

Use this procedure to delete an NIS map:

1. **Start at the UNICON Main Menu and make the following selections:**

- ↳ **Manage Services**
- ↳ **NIS**
- ↳ **Administer NIS**
- ↳ **Manage Master Database**
- ↳ **Maintain Database**

The utility displays the maps in the master domain list described in “Maps in the Master Domain List” on page 209.

2. **Highlight the map and press <Delete>.**

The utility displays a confirmation box.

3. **Select Yes to delete the map or No to cancel the operation.**

If you select Yes, the utility deletes the map and displays the maps in the master domain list.

4. **To return to the Main Menu, press <Esc> as many times as needed.**

The utility displays the Main Menu.

Maintaining the List of Known NIS Servers

Each master NIS server maintains a list of the other NIS servers that service the domain. This list is maintained in the NIS map `ypservers`. When you either add an NIS name server to service a particular domain or remove a server, you must update the `ypservers` map.

Adding an NIS Server to the List of Known Servers

Use this procedure to add an NIS server to the list of servers servicing a domain:

1. **Start at the UNICON Main Menu and make the following selections:**

- ↳ **Manage Services**
- ↳ **NIS**
- ↳ **Administer NIS**
- ↳ **Manage Master Database**
- ↳ **Maintain Database**

The utility displays the maps in the master domain list described in “Maps in the Master Domain List” on page 209.

2. **Select `ypservers`.**

The utility displays the list of known NIS servers servicing the domain.

3. **Press `<Insert>`.**

The utility prompts for the name of the NIS server.

4. **Type the name of the NIS server and press `<Enter>`.**

The utility prompts you to confirm the additions.

5. **Select `Yes` to add the server or `No` to cancel the operation.**

If you select `Yes`, the utility adds the server to the list.

6. **To return to the Main Menu, press `<Esc>` as many times as needed.**

The utility displays the Main Menu.

Deleting an NIS Server from the List of Known Servers

Use this procedure to delete an NIS server from the list of servers servicing a domain:

1. **Start at the UNICON Main Menu and make the following selections:**

- ↳ **Manage Services**
- ↳ **NIS**
- ↳ **Administer NIS**
- ↳ **Manage Master Database**
- ↳ **Maintain Database**

The utility displays the maps in the master domain list described in “Maps in the Master Domain List” on page 209.

2. **Select ypservers.**

The utility displays the list of known NIS servers servicing the domain.

3. **Highlight the server you want to remove and press <Delete>.**

The utility prompts you for confirmation.

4. **Select Yes to delete the server or No to cancel the operation.**

If you select Yes, the utility deletes the server from the list.

5. **To return to the Main Menu, press <Esc> as many times as needed.**

The utility displays the Main Menu.

Backing Up the Master NIS Database

Back up the master NIS database to text to

- ◆ Create a backup copy of the current database

If your database becomes corrupt, you can use the backup copy to reinitialize it, as described in “Initializing the Master NIS Database” on page 211.

- ◆ Move the database to another server

You may want to move the database if you want to create another master server.

The backup copy is stored in SYS:ETC/DBSOURCE/NIS.

Use this procedure to back up the master NIS database:

1. **Start at the UNICON Main Menu and make the following selections:**

- ↳ **Manage Services**
- ↳ **NIS**
- ↳ **Save Master NIS Maps to Text Files**

The utility displays a confirmation box.

2. **Select Yes to back up the NIS database or No to cancel the operation.**

If you select Yes, the utility stores the NIS database in local files.

3. **To return to the Main Menu, press <Esc> as many times as needed.**

The utility displays the Main Menu.

Disabling the NIS Master Server

You may want to disable the NIS master server for a particular domain temporarily if the information in the database becomes corrupt. Use this procedure to disable the master NIS database on the NetWare server:

1. **Start at the UNICON Main Menu and make the following selections:**

- ↳ **Manage Services**
- ↳ **NIS**
- ↳ **Administer NIS**
- ↳ **Enable/Disable Domain Databases**

The utility displays a list of the domains served by the master server.

2. **Select the domain and press <Delete>.**

The utility displays a confirmation box.

3. **Select Yes to disable the server for the specified domain or No to cancel the operation.**

If you select Yes, the utility disables the master NIS server for the specified domain only.

4. **To return to the Main Menu, press <Esc> as many times as needed.**

The utility displays the Main Menu.

Enabling the Master NIS Server

Use this procedure to reenable the NetWare master NIS server for a domain:

1. **Start at the UNICON Main Menu and make the following selections:**

↳ **Manage Services**

↳ **NIS**

↳ **Administer NIS**

↳ **Enable/Disable Domain Databases**

The utility displays a list of the domains served by the master server.

2. **Press <Insert>.**

The utility displays a list of disabled domains.

3. **Select the domain to enable.**

The utility displays a confirmation box.

4. **Select Yes to enable the master server for the specified domain or No to cancel the operation.**

If you select Yes, the utility reenables the master server for the specified domain and redisplay the list of domains served.

5. To return to the Main Menu, press <Esc> as many times as needed.

The utility displays the Main Menu.

Setting up an NIS Master Server

When your environment includes multiple NetWare® Print Services servers or if you use a non-NetWare NIS server, you can set up all NetWare Print Services servers to use the same NIS server. Creating a master NIS server allows all NIS administration procedures to be performed on one server.

Using a NetWare Server as the NIS Master

When your environment includes multiple servers running NetWare UXPS, these servers can all use the same NetWare NIS server to store user and group information. Creating a single master NIS server enables you to perform user and group administration on one server.

For example, if you have three servers named NFS1, NFS2, and NFS3, you can set up NFS2 and NFS3 to use the NIS database on NFS1. For step-by-step instructions, refer to the “Identifying a Different NIS Server as the Master” on page 224.

Note: This method uses only the UNIX® user and group information stored in the NetWare NIS database that you select. If the server resides in a different OU, you must also create or import the actual NetWare user accounts and groups. For instructions on creating new NetWare user accounts and groups, see “Managing User and Group Information” on page 137.

Using a Non-NetWare Server as the NIS Master

When your environment currently includes a non-NetWare NIS server, your NetWare servers can use the existing NIS server. If you use a non-NetWare NIS server, you cannot use UNICON to update UNIX user or group information.

Note: This method uses only the UNIX user and group information stored in the NIS database that you select. You must also create the actual NetWare user accounts and groups on the NetWare server. For instructions on creating NetWare user accounts and groups from existing UNIX accounts, see “Converting UNIX Accounts to NetWare Accounts” on page 150.

Using the Server Profile Configuration Form

The Server Profile Configuration form displays configuration information for a server. Use this form to select an NIS master server.

Displaying the Server Profile Configuration Form

1. To display the Server Profile Configuration form, start at the UNICON Main Menu and make the following selections:

- ↳ Manage Global Objects
- ↳ Configure Server Profile

Server Profile Configuration	
Synchronization Interval:	60 seconds
NIS Client Access:	<enabled>
Domain:	s.jf-argos
Server:	123.45.6.75
DNS Client Access:	<enabled>
Domain:	s.jf-argos.com
Name Server #1:	123.45.6.75
Name Server #2:	<not assigned>
Name Server #3:	<not assigned>

2. Complete procedure and exit.

Understanding the Server Profile Configuration Form

The following fields control NIS access. For a complete description of the other fields, see “Changing the Server Synchronization Interval” on page 284.

NIS Client Access—whether the server can obtain NIS information (be an NIS client).

Warning: Do not disable NIS access at any time unless you specifically do not want NIS to provide user and group information.

(NIS) Domain—the domain in which the server from which this server obtains NIS information is located. You can change the NIS domain by typing a new domain name. When you exit the Server Profile Configuration form, the utility checks to see that you have entered a valid NIS domain. If not, you can return to the Server Profile Configuration form to change the NIS domain or disable NIS access.

(NIS) Server—the IP address of the server from which this server obtains NIS information. Select this field to display a list of servers. Add a server to the list by pressing <Insert> and typing a new address. When you exit the Server Profile Configuration form, the utility checks to see that you entered a valid NIS server address. If not, you can return to the form to change the NIS server address or domain or to disable NIS access.

Note: A server can obtain NIS information from itself.

Identifying a Different NIS Server as the Master

Use this procedure to identify a different NIS master server:

1. **Start at the UNICON Main Menu and make the following selections:**

↳ **Manage Global Objects**

↳ **Configure Server Profile**

The utility displays the Server Profile Configuration form described in “Understanding the Server Profile Configuration Form” on page 223.

2. **Select the (NIS) Domain field.**

The utility highlights the NIS domain name.

3. **If the NIS domain name is the name of the domain in which the new NIS master is located, press <Enter>. Otherwise, type the correct domain name and press <Enter>.**

The utility highlights the NIS Server field. If the utility already has the address of the domain’s server, it displays it in the NIS Server field. If the new address appears in the field, proceed to Step 6.

4. **To enter a different IP address, press <Enter>.**

The utility displays a list of NIS servers in the specified domain. Use <Insert> and <Delete> to add or delete an address from the list.

5. **Highlight the new NIS server address and press <Enter>.**

The utility redisplay the Server Profile Configuration form. The new address appears in the (NIS) Server field.

6. **To exit, press <Esc>. If you need to change the DNS server as well, refer to *Novell DNS/DHCP Services Administrator's Guide*.**

If you press <Esc>, the utility displays the Main Menu.

Creating a Replica of the NIS Database

This section describes how to create and manage replica databases. Create at least one replica of the master NIS database on another NIS server. You should already be familiar with the concept of replica NIS databases. If you are not familiar with this topic, refer to “NIS Replica Servers” on page 11.

Using the Replica NIS Database Screens

Manage replica databases using the following UNICON screens:

- ◆ Replica Domains list
- ◆ Replica Regeneration form

If you need information about a specific field on one of these screens, position the cursor in the field and press <F1>.

Replica Domains List

1. To display the Replica Domains list, start at the UNICON Main Menu and make the following selections:

- ↳ Manage Services
 - ↳ NIS
 - ↳ Administer NIS
 - ↳ Manage Replica Databases



2. Complete procedure and exit.

Replica Regeneration Form

Use the Replica Regeneration form to regenerate the database for a domain or to generate a replica database.

Displaying the Replica Regeneration Form

To display the Replica Regeneration form,

1. Start at the UNICON Main Menu and make the following selections:

- ↳ Manage Services
 - ↳ NIS
 - ↳ Administer NIS
 - ↳ Manage Replica Databases

The utility displays the Replica Domains list described in “Replica Domains List” on page 226.

2. Select a domain.

The utility displays the Replica Regeneration form.

Regeneration of Domain <sjf-argos2.com>, Master Server <sjf-argos2>
sjf-argos2

Understanding the Replica Regeneration Form

This form contains the following fields:

Regeneration of Domain <*domain name*>—the name of domain for which the database will be regenerated or the replica created.

Master Server <*server name*>—the master server on which the maps for the domain are located.

By default, the name or IP address for the master server specified in the header also displays in the entry field. To regenerate the replica database or create a replica using maps on a different server, type in the name of the other server.

Creating the Replica Database

Create at least one replica of your master NIS database on another NIS server.

Use this procedure to create a replica of an NIS database:

1. **Start at the UNICON Main Menu and make the following selections:**

- ↳ **Manage Services**
- ↳ **NIS**
- ↳ **Administer NIS**
- ↳ **Manage Replica Databases**

The utility displays the Replica Domain list described in “Replica Domains List” on page 226.

2. **Press <Insert>.**

The utility prompts you for the name of the domain for which you want to create the replica.

3. **Type the name of the domain and press <Enter>.**

The utility displays the Replica Regeneration prompt, which lists the domain and the master server for that domain. By default, the master server is displayed as the source for the database maps.

4. **Accept the default source server by pressing <Enter> or type another server name and press <Enter>.**

The utility displays a confirmation box.

5. **Select Yes to create the replica or No to cancel the operation.**

If you select Yes, the utility creates the replica and redisplay the Replica Domains list.

6. **To return to the Main Menu, press <Esc> as many times as needed.**

The utility displays the Main Menu.

Deleting a Replica Database

Use this procedure to delete a replica database:

1. **Start at the UNICON Main Menu and make the following selections:**

- ↳ **Manage Services**

- ↳ **NIS**

- ↳ **Administer NIS**

- ↳ **Manage Replica Databases**

The utility displays the Replica Domains list described in “Replica Domains List” on page 226.

2. **Highlight the replica and press <Delete>.**

The utility displays a confirmation box.

3. **Select Yes to delete the database or No to cancel the operation.**

If you select Yes, the utility deletes the replica and displays the Replica Domain list.

4. **To return to the Main Menu, press <Esc> as many times as needed.**

The utility displays the Main Menu.

Querying NIS Servers

If you have problems with NIS, check to make sure the NIS servers are responding to database queries. Use the Query NIS Server form to enter query information.

Displaying the Query NIS Server Form

1. To display the Query NIS Server form, start at the UNICON Main Menu and make the following selections:

- ↳ Manage Services
 - ↳ NIS
 - ↳ Administer NIS
 - ↳ Query Remote Nameserver

Query NIS Server	
Server to Query:	juniper
Domain:	argos.com
Map Name	<see list>
Key Value	*

2. Complete procedure and exit.

Understanding the Query NIS Server Form

This form contains the following fields:

Server to Query—the hostname or IP address of the remote name server.

Domain—the name of the domain for which you want information.

Map Name—the name of the map you want queried. Select this field to display a list of NIS maps.

Key Value field—the key value on which to search. By default, the key value is the asterisk (*) wildcard character, which searches on all key values.

Querying a Remote NIS Nameserver

Use this procedure to query a remote NIS nameserver:

1. **Start at the UNICON Main Menu and make the following selections:**

- ↳ **Manage Services**

- ↳ **NIS**

- ↳ **Administer NIS**

- ↳ **Query Remote Nameserver**

The utility displays the Query NIS Server form.

2. **Fill in the Server to Query field with either the hostname or IP address of the server and press <Enter>.**

If the server responds, the utility highlights the next field.

3. **Type the domain name to query and press <Enter>.**

If the server responds, the utility highlights the next field.

4. **Press <Enter>.**

The utility displays a list of available maps.

5. **Select one of the maps from the list.**

The utility moves to the next field.

6. **Enter a key value (if needed) or accept the default wildcard character and press <Enter>.**

The utility displays the response to the query or displays a message stating that no information was found.

If the server is a master and returns no information, the specified maps do not exist in the database. If the server is a replica and returns no information, either the maps do not exist on the master or the replica is not able to import a complete copy of the database.

7. **To return to the Main Menu, press <Esc> as many times as needed.**

The utility displays the Main Menu.

Managing Shared Files and Using File Functions

This section describes how to manage shared files. You should already be familiar with the idea of file sharing. If you do not understand how file sharing works, refer to the information under “Understanding” on page 1.

This section discusses the following topics:

- ◆ “Copying Files” on page 232
- ◆ “Managing Directory and File Information” on page 242
- ◆ “Editing Files” on page 253
- ◆ “Backing Up and Restoring Files” on page 254

Copying Files

Use the UNICON Copy Files Using FTP option to transfer files to and from computers supporting File Transfer Protocol (FTP). This option enables you to transfer the UNIX* hosts, passwd, and group files from a remote UXPS server to your NetWare® server.

For you to use the file copy function, the remote server must be running the FTP server (FTP daemon on some systems).

Entering Directory Paths and Filenames

When you use FTP, enter paths and filenames in the correct format for the server. For example, if you are logged in to a UNIX host, enter source pathnames in UNIX format (for example, /sys/etc/hosts). If you enter a destination path for a NetWare server, use NetWare format (for example, SYS:ETC/HOSTS).

Using the FTP Screens

Copy files using the following UNICON screens:

- ◆ Status inset
- ◆ FTP Server Login form
- ◆ FTP Server list
- ◆ Get File form
- ◆ Put File form

If you need information about a specific field on one of these screens, position the cursor in the field and press <F1>.

Status Inset

After you connect to an FTP server, a status inset appears at the bottom of your UNICON screen:



This inset contains the following fields:

FTP Server—the name or IP address of the host you logged in to.

User—the username that you used to log in.

Transfer Type—the type of file transfer (ASCII or binary) that is currently specified.

FTP Server Login Form

Use the FTP Server Login form to log in to a remote server.

Displaying the FTP Server Login Form

To display the FTP Server Login form,

1. **Start at the UNICON Main *Menu* and make the following selections:**

↳ **Perform File Operations**

↳ **Copy Files Using FTP**

The first time you select the Copy Files Using FTP option, the utility displays the FTP Server Login form. The next time you select the Copy Files Using FTP option, the utility displays the FTP server list (described in the next section).

2. **To log in to a different (additional) server, press <Insert>.**

The utility displays the FTP Server Login form.

FTP Server Login
FTP Server : Username: Password:

Understanding the FTP Server Login Form

This form contains the following fields:

FTP Server—the name of the remote host, which must be running the FTP server (known as a daemon on some systems).

Username—your remote host user name.

Password—your password (if necessary).

FTP Server List

The FTP server list displays the names or IP addresses of the FTP hosts to which you are logged in and the user names you used to log in.

1. **To display this list, start at the UNICON Main Menu and make the following selections:**

➤ **Perform File Operations**

➤ **Copy Files Using FTP**

If you are logged in to one or more FTP servers, the utility displays the FTP Server list.

FTP Server	User
zipper	supervisor

2. **Complete procedure and exit.**

Get File Form

Use the Get File form to transfer a file from a remote server.

Displaying the Get File Form

To display the Get File form,

1. **Start at the UNICON Main *Menu* and make the following selections:**
 - ↳ **Perform File Operations**
 - ↳ **Copy Files Using FTP**
2. **Select a session from the FTP Server list or log in to an FTP server.**

The utility displays the File Operations menu.

3. **Select Get File.**

The utility displays the Get File form.

Get File	
Source filename:	▶
Destination filename:	▶

Understanding the Get File Form

This form contains the following fields:

Source filename—the full path of the file you want to copy from the remote host.

Destination filename—the full path of the destination file on the NetWare server.

Put File Form

Use the Put File form to transfer a file from your server.

Displaying the Put File Form

To display this form,

1. **Start at the UNICON Main *Menu* and make the following selections:**
 - ↳ **Perform File Operations**
 - ↳ **Copy Files Using FTP**
2. **Select a session from the FTP Server list or log in to an FTP server.**

The utility displays the File Operations menu.

3. **Select Put File.**

The utility displays the Put File form.

Put File	
Source filename:	▶
Destination filename:	▶

Understanding the Put File Form

This form contains the following fields.

Source filename—the full path of the file you want to copy from the NetWare server.

Destination filename—the full path of the destination file on the remote machine.

Connecting to One or More FTP Servers

Use this procedure to connect to an FTP server:

1. **Start at the UNICON Main *Menu* and make the following selections:**

↳ **Perform File Operations**

↳ **Copy Files Using FTP**

The first time you select Copy Files Using FTP, the utility displays the FTP Server Login form described in “FTP Server Login Form” on page 233. If you are logged in to an FTP server, the utility displays the FTP Server Login list described in “FTP Server List” on page 235.

2. **If the *FTP Server Login* form appears, fill in the remote server name and your remote username and password (if necessary) and press <Enter>. If the *FTP Server Login* list appears, either select an FTP server from the list or use <Insert> to log in to an additional server.**

The utility displays the FTP Operations menu. The status window at the bottom of the screen lists the FTP server you are currently logged in to, your user login name, and the FTP file transfer type.

Listing Remote Directories

Use this procedure to list the directories on a remote host:

1. **Start at the UNICON Main *Menu* and make the following selections:**

↳ **Perform File Operations**

↳ **Copy Files Using FTP**

Once you are connected to an FTP server (see “Connecting to One or More FTP Servers” on page 238), the utility displays the File Operations menu.

2. **Select List Directory.**

The utility prompts for the directory path.

3. **Type the pathname of the directory you want listed and press <Enter>.**

The utility lists the contents of the directory.

4. **To exit the list, press <Esc>.**

The utility displays the FTP Operations menu.

5. **Select another FTP operation from the menu or press <Esc> twice to return to the Main Menu.**

Selecting the Transfer Type

Use this procedure to change the file transfer type.

1. **Start at the UNICON Main *Menu* and make the following selections:**

↳ **Perform File Operations**

↳ **Copy Files Using FTP**

Once you are connected to an FTP server (see “Connecting to One or More FTP Servers” on page 238), the utility displays the File Operations menu.

2. **Select Transfer Type.**

The utility displays a list of the transfer types.

3. **Select the appropriate transfer type (ASCII or Binary).**

The file transfer type displays in the status window at the bottom of the screen.

4. **To exit the Select Transfer Type screen, press <Esc>.**

The utility displays the FTP Operations menu.

5. **Select another FTP operation from the menu or press <Esc> twice to return to the Main Menu.**

Copying a File from a Remote Host

Use this procedure to copy a file from a remote host.

1. **Start at the UNICON Main *Menu* and make the following selections:**

- ↳ **Perform File Operations**

- ↳ **Copy Files Using FTP**

Once you are connected to an FTP server (see “Connecting to One or More FTP Servers” on page 238), the utility displays the File Operations menu.

2. **Select Get File.**

The utility displays the Get File form described in “Get File Form” on page 235.

3. **Fill in the Get File form and press <Enter>.**

If the remote file does not exist, the utility displays an error message. Otherwise, the utility transfers the file and redisplay the Get File form.

4. **Repeat Step 3 for each file that you want to transfer.**

5. **To exit the form, press <Esc>.**

The utility displays the FTP Operations menu.

6. **Select another FTP operation from the menu or press <Esc> twice to return to the Main Menu.**

Copying a File to a Remote Host

Use this procedure to copy a file to a remote host:

1. **Start at the UNICON Main *Menu* and make the following selections:**

- ↳ **Perform File Operations**

- ↳ **Copy Files Using FTP**

Once you are connected to an FTP server (see “Connecting to One or More FTP Servers” on page 238), the utility displays the File Operations menu.

2. **Select Put File.**

The utility displays the Put File form described in “Put File Form” on page 237.

3. **Fill in the Put File form and press <Esc>.**

If the local file does not exist, the utility displays an error message. Otherwise, the utility transfers the file and redisplay the FTP Operations menu.

4. **Select another FTP operation from the menu or press <Esc> twice to return to the Main Menu.**

Logging Out of an FTP Server

Use this procedure to log out of an FTP server.

1. **Start at the UNICON Main *Menu* and make the following selections:**

- ↳ **Perform File Operations**

- ↳ **Copy Files Using FTP**

The utility displays the FTP Server list described in “FTP Server List” on page 235.

2. **Highlight the FTP Server from which you want to log out and press <Delete>.**

The utility logs you out of the server and deletes the session from the FTP Server list.

3. To return to the *File Operations* menu, press <Esc>.

The utility returns you to the File Operations menu.

4. Select one of the file operations from the menu or press <Esc> to return to the Main Menu.

Managing Directory and File Information

This section describes how to access information about a directory or file and how to change the file and directory characteristics that are modifiable using UNICON.

Using the Directory and File Information Screens

Manage directories and files using the following UNICON screens:

- ◆ Directory Information form
- ◆ File Information form

If you need information about a specific field on one of these screens, position the cursor in the field and press <F1>.

Directory Information Form

The Directory Information form displays information about a directory in your NFS name space. You can also use this form to modify the access controls on a directory.

Displaying the Directory Information Form

To display the Directory Information form,

1. Start at the UNICON Main *Menu* and make the following selections:
 - ☞ Perform File Operations
 - ☞ View/Set File Permissions

The utility displays the Path entry box.

2. Use either of the following methods to view the Directory Information form.

2a. Type in the full pathname of the directory and press <F9>.

The utility displays the Directory Information form.

2b. Or, press <Insert>.

The utility displays the Available Volumes list.

2c. Select the volume containing the directory.

The utility displays the Directory Contents list.

2d. If your directory is below a directory in the list, select that directory. Repeat until you get to the directory you want. Then highlight the directory and press <F9>.

The utility displays the Directory Information form.

Directory Information	
UNIX Directory Name:	/sys/ntc
DOS Directory Name:	S:\F-ARGES\SYS\ETC
NetWare Owner:	SUPERVISOR
NetWare Group:	<not defined>
	UNIX User ID: 0
	UNIX Group ID: 0
NFS Permissions:	(r-x-r-x) (g-r-x) (o-r-x)
NetWare Attributes:	(-----)
Trustee Rights:	<see list>
Inherited Rights Filter:	{SRUCFPA}
Effective Rights:	{SRUCFPA}
Creation Date:	2-01-99 7:37:54am
Last Modified Date:	10-27-99 2:13:16pm

Understanding the Directory Information Form

This form contains the following fields:

UNIX Directory Name—the full path of the directory in UNIX format.

DOS Directory Name—the full path of the directory in NetWare format, including server name and volume.

NetWare Owner—the NetWare name of the creator of the file.

UNIX User ID—the owner's UNIX user identification number.

NetWare Group—the NetWare name of the group to which the file and the file's owner belong.

UNIX Group ID—the group's UNIX group identification number.

Hard Links—the paths of all hard links to the directory.

NFS Permissions—the UNIX permissions associated with the directory.

NetWare Attributes—the NetWare characteristics assigned to the directory.

Trustee Rights—the NetWare access rights to the directory granted to the owner or assigned user.

Inherited Rights Filter—the NetWare rights that can be revoked from parent directories and container objects.

Effective Rights—the actual rights set on the directory after trustee rights are filtered by the inherited rights filter.

Creation Date—the date and time when the directory was created.

Last Modified Date—the date and time when the directory was last modified.

File Information Form

The File Information form displays information about files in your NFS name space. You can also use this form to modify the access controls on a file.

Displaying the File Information Form

To display the File Information form,

1. **Start at the UNICON Main *Menu* and make the following selections:**

- ↳ **Perform File Operations**

- ↳ **View/Set File Permissions**

The utility displays the Path entry box.

2. **Use one of the following methods to see the File Information form:**

- 2a. **Type in the full pathname of the file and press <F9>.**

The utility displays the File Information form.

- 2b. **Or, press <Insert>.**

The utility displays the Available Volumes list.

- 2c. **Select the volume containing the file.**

The utility displays the Directory Contents list.

- 2d. **If the file is below a directory in the list, select that directory. Repeat until you get to the file you want. Then highlight the file, and press <Enter> or <F9>.**

The utility displays the File Information form.

File Information	
UNIX File Name:	/sys/public/allow.bat
DOS File Name:	SJF-ARGDS\SYS:PUBLIC\ALLOW.BAT
NetWare Owner:	SUPERVISOR UNIX User ID: 8
NetWare Group:	<not defined> UNIX Group ID: 8
Hard Links:	<none>
NFS Permissions:	[U=r--] [G=r--] [O=r--]
NetWare Attributes:	[R=---] [---Sh--- ...]
Trustee Rights:	<none>
Inherited Rights Filter:	{SRACEMFA}
Effective Rights:	{SRACEMFA}
Creation Date:	1-31-94 11:09:22pm
Last Modified Date:	9-24-92 12:48:14pm
File Size:	26

Understanding the File Information Form

This form contains the following fields:

UNIX File Name—the full path of the file in UNIX format.

DOS File Name—the full path of the file in NetWare format, including server name and volume.

NetWare Owner—the name of the creator of the file.

UNIX User ID—the owner's UNIX user identification number.

NetWare Group—the name of the group to which the file and the file's owner belong.

UNIX Group ID— the group's UNIX identification number.

Hard Links—the paths of all hard links to the file.

NFS Permissions—the UNIX permissions associated with the file.

NetWare Attributes—the NetWare characteristics assigned to the file. The first group shows NetWare file characteristics that are comparable to attributes used by DOS and OS/2*. The second group shows NetWare attributes unique to NetWare.

Trustee Rights—the NetWare access rights to the file granted to the owner or assigned user.

Inherited Rights Filter—the NetWare rights that can be revoked from parent directories and container objects.

Effective Rights—the actual rights set on the file after trustee rights are filtered by the inherited rights filter.

Creation Date—the date and time when the file was created.

Last Modified Date—the date and time when the file was last modified.

File Size—the size of the file in bytes.

Viewing Directory or File Information

This section describes how to use UNICON to view directory and file information. You can view information that includes UNIX and DOS names, ownership, hard links, access rights, file size, and creation and modify dates.

Viewing Information about a Directory

Use this procedure to view both UNIX and NetWare information about a directory:

1. **Start at the UNICON Main *Menu* and make the following selections:**

- ↳ **Perform File Operations**

- ↳ **View/Set File Permissions**

The utility displays the Path entry box.

2. **Use either of the following methods to view the Directory Information form:**

- 2a. **Type in the full pathname of the directory and press <F9>.**

The utility displays the Directory Information form described in “Directory Information Form” on page 242.

2b. Or, press <Insert>.

The utility displays the Available Volumes list.

2c. Select the volume containing the directory.

The utility displays the Directory Contents list.

2d. If your directory is below a directory in the list, select that directory. Repeat until you get to the directory you want. Then highlight the directory, and press <F9>.

The utility displays the Directory Information form described in “Directory Information Form” on page 242.

3. To exit the Directory Information form, press <Esc>.

Viewing Information about a File

Use this procedure to view both UNIX and NetWare information about a file:

1. Start at the UNICON Main *Menu* and make the following selections:

↳ **Perform File Operations**

↳ **View/Set File Permissions**

The utility displays the Path entry box.

2. Use either of the following methods to view the File Information form:

2a. Type in the full pathname of the file and press <F9>.

The utility displays the File Information form described in “File Information Form” on page 245.

2b. Or, press <Insert>.

The utility displays the Available Volumes list.

2c. Select the volume containing the file.

The utility displays the Directory Contents list.

2d. If the file is below a directory in the list, select that directory. Repeat until you get to the file you want. Then highlight the file, and press <Enter> or <F9>.

The utility displays the File Information form described in “File Information Form” on page 245.

- 3. To exit the File Information form, press <Esc>.**

Changing Permissions

This section describes how to modify the following information:

- ◆ NFS permissions
- ◆ NetWare attributes
- ◆ Trustee rights
- ◆ Inherited rights filter

For a description of UNIX permissions, refer to “Understanding” on page 1. For a description of NetWare attributes and rights, refer to the documentation for NetWare 5.

Setting NFS (UNIX) Permissions

Use this procedure to modify UNIX permissions on a directory or file.

- 1. Display the Directory Information form or File Information form as described in “Viewing Directory or File Information” on page 247.**

- 2. Select the NFS Permissions field.**

The utility displays the Current NFS Permissions list.

- 3. To delete a currently assigned permission, highlight it and press <Delete>.**

- 4. To add a permission, press <Insert>.**

The utility displays the Other NFS Permissions list.

- 5. Select the permission you want to add.**

The permission is added to the Current NFS Permissions list.

- 6. When you are finished modifying permissions, press <Esc> twice.**

If you made a change, the utility displays a confirmation box.

- 7. Select Yes to save any changes or No to cancel the operation.**

If you select Yes, the utility saves the changes.

- 8. To return to the Main Menu, press <Esc>.**

The utility displays the Main Menu.

Setting NetWare Attributes

Use this procedure to modify NetWare attributes for a directory or file.

- 1. Display the Directory Information form or File Information form as described in “Viewing Directory or File Information” on page 247.**

- 2. Select the NetWare Attributes field.**

The utility displays the Current Attributes list.

- 3. To delete an attribute, highlight it and press <Delete>.**

- 4. To add an attribute, press <Insert>.**

The utility displays the Other Attributes list.

- 5. Select the attribute(s) you want to add.**

The attributes are added to the Current Attributes list.

- 6. When you are finished modifying attributes, press <Esc> twice.**

If you made a change, the utility displays a confirmation box.

- 7. Select Yes to save any changes or No to cancel the operation.**

If you select Yes, the utility saves the changes.

- 8. To return to the Main Menu, press <Esc>.**

The utility displays the Main Menu.

Setting Trustee Rights

Use this procedure to modify trustee rights for a directory or file.

- 1. Display the Directory Information form or File Information form as described in “Viewing Directory or File Information” on page 247.**

- 2. Select the Trustee Rights field.**

The utility displays the list of trustees assigned to the directory or file and their associated rights.

- 3. To delete a trustee, highlight it and press <Delete>.**

- 4. To modify a current trustee’s rights, press <Enter> and skip to the response for Step 7.**

- 5. To add a trustee, press <Insert>.**

The utility prompts for whether the trustee is a user or a group.

- 6. Select either User or Group.**

The utility displays a browser list of user objects within the domain. For a description of the browser, see “Using the Object Browser” on page 115.

- 7. Select the users to be assigned as trustees.**

The utility displays the Current Rights list.

- 8. To delete currently assigned rights, highlight them and press <Delete>.**

- 9. To add rights, press <Insert>.**

The utility displays the Other Rights list.

- 10. Select the right(s) you want to add.**

The rights are added to the Current Rights list.

- 11. Press <Esc>.**

- 12. When you are finished modifying trustee rights, press <Esc> twice.**

If you made a change, the utility displays a confirmation box.

- 13. Select Yes to save any changes or No to cancel the operation.**

If you select Yes, the utility saves the changes.

- 14. To return to the Main Menu, press <Esc>.**

The utility displays the Main Menu.

Setting the Inherited Rights Filter

Use this procedure to set the inherited rights filter:

- 1. Display the Directory Information form or File Information form as described in “Viewing Directory or File Information” on page 247.**

- 2. Select the Inherited Rights Filter.**

The utility displays the Current Inherited Rights list.

- 3. To delete a currently assigned inherited right, highlight it and press <Delete>.**

- 4. To add an inherited right, press <Insert>.**

The utility displays the Other Inherited Rights list.

- 5. Select the inherited right(s) you want to add.**

The rights are added to the Current Inherited Rights list.

- 6. When you are finished modifying inherited rights, press <Esc> twice.**

If you made a change, the utility displays a confirmation box.

- 7. Select Yes to save any changes or No to cancel the operation.**

If you select Yes, the utility saves the changes.

8. **To return to the Main Menu, press <Esc>.**

The utility displays the Main Menu.

Editing Files

The UNICON editor enables you to edit files on the NetWare server. You can use this editor to edit files containing up to 64,000 bytes.

Use this procedure to edit a file:

1. **Start at the UNICON Main *Menu* and make the following selections:**

- ↳ **Perform File Operations**

- ↳ **Edit File**

The utility prompts for the name of the file.

2. **Type the pathname of the file and press <Enter>.**

If the file does not exist, the utility offers to create the file. If you answer Yes or if the file already exists, the file appears in an editing screen.

3. **Edit the file as necessary.**

4. **To end the edit session, press <Esc>.**

If you changed the file, the utility displays a confirmation box.

5. **Select Yes to save any changes or No to cancel the operation.**

If you select Yes, the utility saves the changes.

6. **To return to the Main Menu, press <Esc>.**

The utility displays the Main Menu.

Backing Up and Restoring Files

This section explains how to back up and restore files using the NetWare® and UNIX* utilities.

Using NetWare

NetWare has facilities to ensure that data is not lost or corrupt. NetWare provides many of the same features as other NFS servers, as well as some unique features. The following paragraphs introduce the NetWare SBACKUP utility and the FILER salvage option. For more information, refer to the documentation for NetWare 5.

Using the SBACKUP Utility

The SBACKUP utility backs up NetWare files that support multiple name spaces, such as NFS and Macintosh* files.

Using the “Salvage Deleted Files” Option

The FILER salvage option recovers files that have been erased. When users erase a file from either NFS or NetWare, NetWare keeps a backup copy of the file on the server. Backup copies are not removed until the server needs additional disk space or they are purged by the owner or the NetWare supervisor. You can use the salvage option to restore backup files that have not yet been purged.

Using UNIX

Use the UNIX backup utilities when you need to back up and restore files from NetWare directories that are mounted to a UNIX computer. When you use UNIX utilities to back up files, only NFS file information is saved. If you back up an NFS file, remove it from the server, and then restore it with a UNIX utility, the following NetWare file information may be lost:

- ◆ NetWare file attributes that override effective rights, such as Copy Inhibit on files and Delete Inhibit on directories
- ◆ Last archival date and time

- ◆ Last archival identification
- ◆ Last update identification
- ◆ Inherited rights filter
- ◆ Trustee rights

File information specific to other name spaces, such as a Macintosh name space, is also lost.

Managing the File Transfer Protocol (FTP) Service

This section describes how to manage the NetWare® File Transfer Protocol (FTP) service. You should already understand how FTP operates. If you are not familiar with FTP, see “FTP File Transfer Service” on page 44.

This section discusses the following topics:

- ◆ “Displaying Information About Open FTP Sessions” on page 256
- ◆ “Deleting an Open FTP Session” on page 258
- ◆ “Managing User Accounts” on page 259
- ◆ “Setting the FTP Server Parameters” on page 264
- ◆ “Restricting Access to FTP” on page 267
- ◆ “Using the FTP Log Files” on page 270
- ◆ “NetWare FTP Client Usage” on page 276

Displaying Information About Open FTP Sessions

Display information about open FTP sessions using the UNICON Detailed Session Statistics form. If you need information about a specific field on this form, position the cursor in the field and press <F1>.

Displaying the Detailed Session Statistics Form

To display the Detailed Session Statistics form,

1. **Start at the UNICON Main *Menu* and make the following selections:**

- ↳ **Manage Services**
- ↳ **FTP Server**
- ↳ **View Current FTP Sessions**

The utility displays a list of active sessions.

2. **Select a session.**

The utility displays the Detailed Session Statistics form.

Detailed Session Statistics	
Client's Username:	root
Client's Address:	138.57.5.111
Number of Files Sent to the Server:	0
Number of Files Retrieved from the Server:	0
File Transfer Rate:	0 bytes/second
Total Bytes Transferred:	0
Total Time Since Initial Login:	0 hours 11 minutes
Total Idle Time Since Last Command:	0 hours 6 minutes
Current File Server:	alaxl
Current Working Directory:	/afs/afx
Last Command:	LIST

Understanding the Detailed Session Statistics Form

This form contains the following fields:

Client's Username—the name used to log in to the FTP session.

Client's Address—the IP address of the FTP client.

Number of Files Sent to the Server—the number of files sent to the NetWare FTP server.

Number of Files Retrieved from the Server—the number of files retrieved from the NetWare FTP server.

File Transfer Rate—the rate of transfer for the last FTP transaction.

Total Bytes Transferred—the total number of bytes transferred since the start of the FTP session.

Total Time Since Initial Login—the duration of the session in hours and minutes.

Total Idle Time Since Last Command—the amount of time in hours and minutes since the last FTP command was issued.

Current File Server—the name of the NetWare server to which the user is connected.

Current Working Directory—the pathname of the current working directory.

Last Command—the last FTP command issued.

Displaying Statistics for an FTP Session

Use this procedure to display details about an open FTP session.

1. **Start at the UNICON Main *Menu* and make the following selections:**

- ⇒ **FTP Server**

- ⇒ **View Current FTP Sessions**

The utility displays a list of users and the IP addresses of the FTP client hosts.

2. **Select the session about which you want information.**

The utility displays the Detailed Session Statistics form described in “Displaying the Detailed Session Statistics Form” on page 256.

3. **To exit the form, press <Esc>.**

The utility displays the user list.

4. **Repeat Steps 2 and 3 to view information about other sessions.**

5. **To return to the Main Menu, press <Esc>.**

Deleting an Open FTP Session

Use this procedure to end an open FTP session:

1. **Start at the UNICON Main *Menu* and make the following selections:**

- ⇒ **Manage Services**

- ⇒ **FTP Server**

- ⇒ **View Current FTP Sessions**

The utility displays a list of users and the IP addresses of the FTP client hosts.

2. **Highlight the session to be deleted and press <Delete>.**

The utility displays a confirmation box.

3. **Select Yes to delete the session or No to cancel the operation.**

If you select Yes, the utility removes the entry from the list and decrements the number of currently active FTP sessions.

4. **To return to the Main Menu, press <Esc> as many times as needed.**

The utility displays the Main Menu.

Managing User Accounts

FTP includes an anonymous user account. This account, which requires no password, provides people with access to public files. FTP also includes a default home directory for users whose home directory is not on the server.

Manage FTP user accounts using the UNICON Anonymous User's Home Directory form and the Default User's Home Directory form. If you need information about a specific field on one of these forms, position the cursor in the field and press <F1>.

Anonymous User's Home Directory Form

The Anonymous User's Home Directory form displays information describing the location of the anonymous user's home directory.

Displaying the Anonymous User's Home Directory Form

To display the Anonymous User's Home Directory form,

1. **Start at the UNICON Main Menu and make the following selections:**
 - ↳ **Manage Services**
 - ↳ **FTP Server**
 - ↳ **Set Parameters**

The utility displays the FTP Server Parameters form described in "FTP Server Parameters Form" on page 264.

2. **Select the Anonymous User's Home Directory field.**

The utility displays the Anonymous User's Home Directory form.

Anonymous User's Home Directory	
VOLUME NAME:	SYS
Directory Name:	

Understanding the Anonymous User's Home Directory Form

This form contains two fields:

Volume Name—the volume on which the anonymous user's home directory is located.

Directory Name—the path of the anonymous user's home directory.

Default User's Home Directory Form

The Default User's Home Directory form displays information describing the location of the default user's home directory.

Displaying the Default User's Home Directory

To display the Default User's Home Directory form,

1. **Start at the UNICON Main Menu and make the following selections:**
 - ⇒ **Manage Services**
 - ⇒ **FTP Server**
 - ⇒ **Set Parameters**

The utility displays the FTP Server Parameters form described in "FTP Server Parameters Form" on page 264.

2. **Select the Default User's Home Directory field.**

The utility displays the Default User's Home Directory form.

Default User's Home Directory	
Volume Name:	SVS
Directory Name:	

Understanding the Default User's Home Directory

This form contains two fields:

Volume Name—the volume on which the default user's home directory is located.

Directory Name—the path of the default user's home directory.

Setting up the Anonymous User's Home Directory

The anonymous user cannot access files above the home directory. The home directory for this user is determined in the following manner:

1. NDS™ home directory if the path exists on the server.
2. User's Trustee assignment to a directory by the same name as the user.
3. Default user home directory specified under FTP server parameters. For a description of the FTP server parameters, see "FTP Server Parameters Form" on page 264.

Use this procedure to create the anonymous user account if one does not already exist in the FTP Server's default context and to set up a home directory for anonymous users:

1. **Start at the UNICON Main *Menu* and make the following selections:**

- ↳ **Manage Services**
- ↳ **FTP Server**
- ↳ **Set Parameters**

The utility displays the FTP Server Parameters form described in "FTP Server Parameters Form" on page 264.

2. **Select the Anonymous User Access field.**

The utility displays a confirmation box.

3. **Select Yes to allow anonymous user access or No to cancel the operation.**

If you select Yes, the Anonymous User Access field indicates Yes and the Anonymous User's Home Directory field displays the home directory.

4. **Highlight the Anonymous User's Home Directory field and press <Enter>.**

The utility displays the Anonymous User's Home Directory form described in "Anonymous User's Home Directory Form" on page 259.

5. **Highlight the Volume Name field and type in the name of the NetWare volume.**

The volume must be on the same server as the FTP server.

6. **Highlight the Directory Name field and type in the path of the home directory.**

7. **To return to the Main Menu, press <Esc> as many times as needed.**

The utility displays the Main Menu.

Disabling the Anonymous User Account

Use this procedure to disable the anonymous user account:

1. **Start at the UNICON Main *Menu* and make the following selections:**

- ↳ **Manage Services**
- ↳ **FTP Server**
- ↳ **Set Parameters**

The utility displays the FTP Server Parameters form described in “FTP Server Parameters Form” on page 264.

2. **Select the Anonymous User Access field.**

The utility displays a confirmation box.

3. **Select No.**

The utility disables the anonymous user account and changes the Anonymous User Access field to No.

4. **To return to the Main Menu, press <Esc> as many times as needed.**

The utility displays the Main Menu.

Setting up the Default Home Directory

The default home directory on the FTP server is for use by any user who does not already have a home directory on the server.

Use this procedure to set up a default home directory:

1. **Start at the UNICON Main *Menu* and make the following selections:**

- ↳ **Manage Services**
- ↳ **FTP Server**
- ↳ **Set Parameters**

The utility displays the FTP Server Parameters form described in “FTP Server Parameters Form” on page 264.

2. **Select the Default User's Home Directory field.**

The utility displays the Default User's Home Directory form described in "Default User's Home Directory Form" on page 260.

3. **Highlight the Volume Name field and type in the NetWare volume.**

The volume you enter must be on the same server as the FTP server.

4. **Highlight the Directory Name field and type in the path of the home directory.**

5. **To return to the Main Menu, press <Esc> as many times as needed.**

The utility displays the Main Menu.

Setting the FTP Server Parameters

Set the FTP Server parameters using the UNICON Server Parameters form. If you need information about a field on this form, position the cursor in the field and press <F1>.

FTP Server Parameters Form

The FTP Server Parameters form displays configuration information for a NetWare® FTP server. Use this form to configure an FTP server.

Displaying the FTP Server Parameters Form

To display the FTP Server Parameters form,

1. **Start at the UNICON Main Menu and make the following selections:**
 - ↳ **Manage Services**
 - ↳ **FTP Server**
 - ↳ **Set Parameters**
2. **Complete procedure and exit.**

Understanding the FTP Servers Parameters Form

This form contains the following fields:

Maximum Number of Sessions—the number of FTP sessions that can run concurrently.

Maximum Session Length—how long a session can remain open.

Idle Time Before FTP Server Unloads—how long the FTP server remains loaded when there are no open sessions.

Anonymous User Access—whether an anonymous user can access the FTP server.

Default User's Home Directory—the home directory for a user who does not have a home directory on the NetWare server. The utility prompts you for the volume name and directory name.

Anonymous User's Home Directory—the home directory for anonymous users. The utility prompts you for the volume name and directory name.

Default Name Space—the default name space for all users. You can select DOS or NFS name space.

Intruder Detection—whether intruder detection is enabled. When intruder detection is enabled, the server records unsuccessful login information in the Intruder Log File (described in “Intruder Log File” on page 271). The server also sends an SNMP alert message to the Network Management Console. The next two parameters control when the information is logged and the alert sent.

Number of Unsuccessful Attempts—how many unsuccessful attempts are allowed before information is logged. The number of attempts is tabulated only within the time period specified by the reset interval.

Detection Reset Interval—the time interval within which unsuccessful login attempts are tabulated.

For example, suppose the number of unsuccessful attempts is set at six and the specified time interval is set at 3,000 minutes. When the first unsuccessful attempt is made, the count and time begin. If five additional failed attempts occur within the 3,000-minute time period, the FTP server records the login information, including any additional attempts.

Log Level—the information recorded in the FTP Log file. Select this field to display the following levels:

- ◆ None—no information is recorded.
- ◆ Logins—login information only is recorded.
- ◆ Statistics—the number of files copied to and from the FTP Server is recorded. This level also includes login information.
- ◆ File—a description of all FTP transactions is recorded. This level also includes login and statistics information.

Modifying the FTP Server Parameters

Use this procedure to view or change FTP parameter settings:

1. **Start at the UNICON Main *Menu* and make the following selections:**

- ↳ **Manage Services**
- ↳ **FTP Server**
- ↳ **Set Parameters**

The utility displays the FTP Server Parameters form described in “FTP Server Parameters Form” on page 264.

2. **Edit the parameters as necessary.**

If you enter an incorrect value, the utility displays the correct range for the parameter.

3. **To exit the form, press <Esc>.**

The utility displays a confirmation box.

4. **Select Yes to save your changes or No to exit without saving your changes.**

The utility displays the FTP Administration menu.

5. **To return to the Main Menu, press <Esc> twice.**

The utility displays the Main Menu.

Restricting Access to FTP

UNICON enables you to define which users can transfer files using FTP by creating an FTP access file.

FTP Access File

The FTP access file (SYS:ETC/RESTRICT.FTP) is an editable file that allows you to define FTP access. If RESTRICT.FTP is empty or does not exist, no FTP access is permitted to the server.

Displaying the FTP Access File

To display the FTP access file,

1. **Start at the UNICON Main Menu and make the following selections:**
 - ↳ **Manage Services**
 - ↳ **FTP Server**
 - ↳ **Restrict FTP Access**

```

SYS:etc/res:ctrl.flp

#          FTP Server Access Control File
#
# This file determines who can access files through the ftp server.
# USER MUST BE SPECIFIED TO GAIN ACCESS.  The default configuration is
# all users access.
#
# syntax:
# <username> [ACCESS=DENY,GUEST,NOREMOTE,READONLY]
#           [ADDRESS=<hostname>,<hostgroup>]
#
# <username>  all users ("*")
#             all users from a NDS context ("*.ou=sales.o=acme")
#             nds user relative to the default context ("bill")
#             complete NDS name containing preceding "." ("admin.o=
#

```

2. Complete procedure and exit.

Understanding the FTP Access File

Enter information in the following format to define FTP access:

```

username [ACCESS=GUEST|READONLY|
          NOREMOTE,DENY,NORMAL]
[ADDRESS=hostname,IP_Address,*]

```

username identifies one or more users:

- ◆ An * (asterisk) by itself identifies all users
- ◆ An * (asterisk) as part of an NDS context identifies all users within the specified context (for example, as *.ou=sales.o=acme).
- ◆ A username without a context identifies a user relative to the user's default context (for example, BILL).
- ◆ The complete pathname for a user identifies that user (for example, .admin.o=acme).

ACCESS designates how the user can access the file system. The default is NORMAL.

- ◆ GUEST restricts the user to the home directory and all files and subdirectories in the home directory.
- ◆ READONLY prevents the user from copying files.
- ◆ NOREMOTE limits the user to files on the local FTP server.
- ◆ DENY prevents the user from logging in to the server.
- ◆ NORMAL applies no special restrictions to the user. NORMAL is the default setting.

ADDRESS identifies the client from which the user can log in. The address can be a hostname or an IP address. If ADDRESS is not specified, the client's address is not checked.

Here are three examples of RESTRICT.FTP entries:

```
* ACCESS=READONLY | NOREMOTE
```

This example allows all users to have READ access to files on the local FTP server only.

```
BILL
```

This example allows BILL to have NORMAL access from any host.

```
TEST1/SUPERVISOR ACCESS=NORMAL
```

This example allows the user named SUPERVISOR, who is on the server TEST1, to have unlimited FTP access.

Defining FTP Access

Use this procedure to define who has FTP access:

1. **Start at the UNICON Main *Menu* and make the following selections:**

- ↳ **Manage Services**
- ↳ **FTP Server**
- ↳ **Restrict FTP Access**

The utility displays the restrict FTP access file (SYS:ETC/RESTRICT.FTP) described in “FTP Access File” on page 267.

2. **Edit the file as necessary.**

For information about the format of this file, see “FTP Access File” on page 267.

3. **To return to the Main Menu, press <Esc> twice.**

The utility displays the Main Menu.

Using the FTP Log Files

UNICON includes two log files:

- ◆ FTPSERV.LOG maintains an activity record for FTP sessions.
- ◆ INTRUDER.FTP maintains a record of failed login attempts.

FTP Log File

The FTP log file (SYS:ETC/FTPSERV.LOG) records information on logins and FTP activity. The amount and type of information is controlled by the Log Level parameter described in “Understanding the FTP Servers Parameters Form” on page 265.

The file records FTP activity for each user. After a session ends, the activity record for that session is appended to the FTPSERV.LOG file. A double line separates the entries for each session.

1. To display this file, start at the UNICON Main Menu and make the following selections:

↳ Manage Services

↳ FTP Server

↳ View FTP Log File

```

SYS:etc/ftpstrv.log
Wed Mar 23 16:11:22 1999 FTP Session Starts from 123.45.6.7.
Wed Mar 23 16:11:46 1999 8 files copied from server.
0 files copied to server.
Wed Mar 23 16:11:46 1999 FTP Session Ends from 123.45.6.7.

```

2. Complete procedure and exit.

Intruder Log File

The intruder log file (SYS:SYSTEM/INTRUDER.FTP) records information about unsuccessful login attempts. (For information about intruder detection, see “Intruder Detection,” described in “Understanding the FTP Servers Parameters Form” on page 265.)

Recorded information includes:

- ◆ Time of attempted access
- ◆ Login name of the user attempting access
- ◆ Incorrect password

1. To display this file, start at the UNICON Main Menu and make the following selections:

- ↳ Manage Services
 - ↳ FTP Server
 - ↳ View Intruder Log File

```
SYS:system/intruder.ftp

Intruder Alert. Address 130.57.5.111 has exceeded the limit
Time 2-09-94 9:19:13am User root used password ROOT .
Time 2-09-94 9:19:02am User .CN=admin.novell used password PEACE46 .
Time 2-09-94 9:18:48am User .CN=admin.novell used password PEACE46 .
Time 2-09-94 9:18:31am User .CN=admin.novell used password PEACE46 .

5 unsuccessful logins from address 130.57.5.111
Time 2-09-94 9:19:33am User supervisor used password PEACE46 .

6 unsuccessful logins from address 130.57.5.111
Time 2-09-94 9:19:39am User test used password TEST .

Intruder Alert. Address 130.57.6.173 has exceeded the limit
Time 2-24-94 6:54:53pm User test used password TEST .
Time 2-24-94 6:54:38pm User test used password TEST .
Time 2-24-94 6:54:33pm User .CN=admin.novell used password PEACE46 .
```

2. Complete procedure and exit.

Determining FTP Service Usage

Note: The Log Level parameter controls the level of reporting. Complete the procedure in “Setting the FTP Server Parameters” on page 264 to set the Log Level parameter.

Use this procedure to view what activities have occurred during past FTP sessions:

1. **Start at the UNICON Main *Menu* and make the following selections:**

- ↳ **Manage Services**

- ↳ **FTP Server**

- ↳ **View FTP Log File**

The utility displays the FTP log file (SYS:ETC/FTPSERV.LOG) described in “FTP Log File” on page 270.

2. **To return to the Main Menu, press <Esc> as many times as needed.**

The utility displays the Main Menu.

Enabling Intruder Detection

Use this procedure to set up intruder detection:

1. **Start at the UNICON Main *Menu* and make the following selections:**

- ↳ **Manage Services**

- ↳ **FTP Server**

- ↳ **Set Parameters**

The utility displays the FTP Server Parameters form described in “FTP Server Parameters Form” on page 264.

2. **Select the Intruder Detection field.**

The utility displays a confirmation box.

3. Select Yes.

The utility displays the default number of unsuccessful attempts and the default detection reset interval.

4. Modify the number of attempts and the reset interval if necessary.

5. To return to the Main Menu, press <Esc> as many times as needed.

The utility displays the Main Menu.

Disabling Intruder Detection

Use this procedure to disable intruder detection:

1. Start at the UNICON Main *Menu* and make the following selections:

↳ **Manage Services**

↳ **FTP Server**

↳ **Set Parameters**

The utility displays the FTP Server Parameters form described in “FTP Server Parameters Form” on page 264.

2. Select the Intruder Detection field.

The utility displays a confirmation box.

3. Select No.

The utility changes the Intruder Detection field to No.

4. To return to the Main Menu, press <Esc> as many times as needed.

The utility displays the Main Menu.

Determining Unauthorized Access

Note: The Intruder Detection parameter controls detection. Complete the procedure in “Setting the FTP Server Parameters” on page 264 to set the Intruder Detection parameter.

Use this procedure to view unauthorized attempts to access the FTP server:

1. **Start at the UNICON Main *Menu* and make the following selections:**

- ↳ **Manage Services**
- ↳ **FTP Server**
- ↳ **View Intruder Log File**

The utility displays the intruder log file (SYS:SYSTEM/INTRUDER.FTP) described in “Intruder Log File” on page 271.

2. **To return to the Main Menu, press <Esc> as many times as needed.**

The utility displays the Main Menu.

Clearing the Log Files

Note: This procedure deletes the log files. The FTP server creates new files when a new session is started.

Use this procedure to remove either the FTP log file or the intruder log file:

1. **Start at the UNICON Main *Menu* and make the following selections:**

- ↳ **Manage Services**
- ↳ **FTP Server**
- ↳ **Clear Log Files**

The utility displays the Clear Log Files menu.

2. **Select the log file that you want to delete.**

The utility displays a confirmation box.

3. **Select Yes to remove the file and its contents.**

The utility displays the FTP Administration menu.

4. **Repeat Steps 2 and 3 to delete the other log file or press <Esc> twice to return to the Main Menu.**

The utility displays the Main Menu.

NetWare FTP Client Usage

This section describes aspects of NetWare® client FTP usage that are unique to the NetWare FTP service.

Recording the FTP Client's Address Using NetWare Auditing

If you are using the NetWare AUDITCON utility to audit FTP file access, you can use one of the auditing events to identify which clients request FTP file access. The NLM™ Add User ID Record event records the IP address of the particular client requesting file access.

The audit log record that contains the client's IP address looks like this:

```
14:58:58 NLM Add User ID Record,event 73,  
name root-connection 8-FTP Server,  
address 130.57.5.111, status 0,  
user server, connection 0
```

If this event is not enabled, the audit trail records the NCP (NetWare) address of the FTP server as the requestor. Make sure you enable the event on the SYS: volume.

For more information about AUDITCON, refer to the documentation for NetWare 5.

Use this procedure to record the client's IP address.

1. **Log in to the NetWare FTP server from AUDITCON by selecting Auditor Volume Login from the Available Audit Options menu.**

2. **Start at the AUDITCON Available Audit Options menu and make the following selections:**
 - ↳ **Auditing Configuration**
 - ↳ **Audit By Event**
 - ↳ **Audit By Server Events**
3. **Select the NLM Add User ID Record event.**
4. **Press <F10>.**

Accessing a Remote Server

You can access files on a remote NetWare server in your NDS tree or bindery context even if the server is not running the FTP service. Access the files by logging in to the server directly or by changing directories to the remote server.

When you are in an FTP session with a NetWare server running FTPSERV, to log in to a remote server you specify the server name and username, separated by a slash mark (/). The username can be the name used in the initial FTP session login, or you can specify a new FTP username using the USER command. The USER command enables you to log in to a remote NetWare 3.x server without having to log in to NDS or the NetWare server running the FTP service.

Remote access entails the following limitations:

- ◆ Remote access is not granted to anonymous users.
- ◆ You cannot rename files.
- ◆ You cannot move files between servers.
- ◆ Only the DOS namespace is supported for all remote volumes.
- ◆ Use of the slash (/) for root and the tilde (~) for login directory works only for the home server where the user initially logged in. For example, if you initially logged in to server joe-server and you are currently on server fred-server, when you enter the command `cd /`, you actually switch to the root directory on joe-server.

Remote Servers without FTPSERV

You can also access files on a remote NetWare server that is not running FTPSERV or TCP/IP, such as a NetWare server running an earlier version of NetWare. To allow such access, set up a password on the remote server that is the same as the one used on the local server. If the password is not the same, FTP denies access to the remote server.

To access the remote (non-FTPSERV) NetWare server, do the following:

- 1. Log into the FTP server by typing**

```
FTP SERVER
```

Replace *SERVER* with the name of the local NetWare server running FTPSERV.

- 2. Enter your name and password when prompted.**

- 3. Issue FTP commands as usual.**

Use the following format to identify files and directories on the remote server:

```
//remote_server_name/volume/directory_pathname
```

The double slash (//) indicates that the next element is the name of the remote server, and the name of the remote server must follow the double slash. Enter the *volume* and *directory_pathname* in UNIX® format, not NetWare format. For example,

```
//joe-server/sys/public
```

The remote server name can be specified as either the server name (for example, joe-server as above) or the NDS name (for example, .joe-server.ou=sales.ou=western.o=acme).

Accessing a Remote IBM Host

You can access files on a remote IBM host through FTP Server if the AFTP Gateway is configured and running on the same local server as the FTP Server. The AFTP Gateway is supported in NetWare for SAA version 2.2 or later. All IBM hosts that are configured under NetWare for SAA can be set up for access with the FTP Server. For instructions on using the AFTP Gateway, see the NetWare for SAA documentation.

All FTP commands that specify a path will work on IBM hosts if the remote server name for the host is given with an @ symbol in front. For example, the command

```
cd //@ibm-server/
```

would log you in to the IBM host `ibm-server` with the same username and password that you used to log in to the FTP server. The current path for FTP would then be on the IBM host.

The following command would let you log in as user `bill` to the server `ibm-server` without having to log in to the NetWare server:

```
user @ibm-server/bill
```

Using the STAT and SITE Commands

The NetWare FTP server supports two useful nonstandard commands:

- ◆ STAT inquires about the status of the current connection or the status of a file or directory.
- ◆ SITE provides special file transfer services specific to your system.

STAT Command

The STAT command has the following syntax:

```
QUOTE STAT [pathname]
```

Note: Because STAT is a universal FTP protocol element and not a particular FTP client command, the command QUOTE tells the FTP client to send the remainder of the command line to the FTP server exactly as entered.

Replace *pathname* with the full pathname of the file.

Using the STAT Command without the Pathname Entry

Use the STAT command without the optional pathname to obtain the status of the connection's transfer parameters. The information you see is in the following format:

Client node:	<i>Client host name or IP address</i>
Client name:	<i>NetWare username</i>
UNIX User Name:	<i>Username</i>
UNIX UID:	<i>Number</i>
Directory	<i>Current working directory</i>
Type:	<i>Current setting of TYPE transfer parameters</i>
Structure:	<i>Current data transfer STRUCTURE</i>
Mode:	<i>Current data transfer MODE</i>
Namespace:	<i>Namespace for current directory</i>
NDS Context:	<i>Complete name</i>

TYPE is a data transfer type that consists of two related parameters:

- ◆ TYPE_major is a major parameter. The value can be either ASCII or Image.
- ◆ TYPE_minor is a minor parameter. If the major parameter is ASCII, the minor parameter is Non-Print. If the major parameter is Image, the minor parameter is a number specifying the local byte size.

STRUCTURE is a data transfer structure that indicates a file structure or a record structure.

MODE is a data transfer mode that indicates stream mode.

An example response to the STAT command follows:

```
211 Status on osd-sanserv
Client node:      Joy3
Client name:     SUPERVISOR
UNIX User Name:  root
UNIX UID:       0
Directory:      /sys
Type:           Ascii Non-Print
Structure:      File
Mode:           Stream
Namespace:      DOS
NDS Context:    ou=eng3.o=company
211 End of Status.
```

Using the STAT Command with the Pathname Entry

If a pathname is specified with the STAT command, the server responds in one of the following ways:

If *pathname* is a directory, the system simply indicates D for directory:

```
D <pathname>
```

If *pathname* is a file, the system suggests the best set of FTP transfer parameters for retrieving the file:

```
<TYPE_major> <TYPE_minor> <STRU> <MODE> <pathname>
```

The system replaces the variables with the following transfer parameters:

- ◆ *TYPE_major* is a data transfer type. The value can be A for ASCII or I for Image.
- ◆ *TYPE_minor* is a data transfer type that can be N for Non-Print (used with ASCII and Image) or a number specifying the local byte size (used for Local).

- ◆ *STRU* is a data transfer structure that can be F for File Structure or R for Record Structure.
- ◆ *MODE* is a data transfer mode that is S for Stream Mode.

SITE Command

The SITE command enables FTP clients to access features specific to the NetWare FTP server, such as name space, remote servers, and NDS.

If the client changes the name space, the change affects only those volumes that support the specified name space. (For example, if the FTP user's current directory is `/sys`, which in this example doesn't support NFS name space, then changing the FTP connection to the NFS name space has no effect on the operation of this volume.)

The SITE command has the following syntax:

```
QUOTE SITE [HELP | CX | DOS | NFS | OU | PATH | SERVER
            | SLIST ]
```

Note: Because SITE is not a standard FTP user command, the command QUOTE tells the FTP client to send the remainder of the command line to the FTP server exactly as entered.

The parameters are defined as follows:

- ◆ HELP displays a description of and the syntax for all SITE commands.
- ◆ CX with a context displays and sets the NDS context that the FTP server uses relative to this FTP client. The CX parameter enables the user to browse the NDS tree for servers or directory maps. Other site commands display servers, directory maps, and container objects (OUs) in the current context. The FTP service uses the context to translate usernames specified in the user command, which can be relative to the full NDS name. The service also uses the context to access directory maps when specified at the beginning of a file pathname.

CX without a context displays the current context of the FTP client. Replace *context* with any one of the following:

- ◆ Two periods (..) change the current context to the parent container.
- ◆ SERVER resets the context back to the current server's default context.
- ◆ OU=*path* sets the context to that of the organizational unit specified by *path*, where *path* can be relative or absolute, as in the following examples:

cx ou=test—sets the context to the OU test using the relative context.

cx .ou=test.o=acme—sets the context to the OU test using the absolute context.

- ◆ DOS enables users to display and access files in DOS format. Both local and remote volumes support this feature.
- ◆ NFS enables users to display and access files in UNIX format. This feature is supported only on local FTP server volumes with the NFS namespace.
- ◆ OU enables users to display the NDS organizations (containers) below the current NDS context.
- ◆ PATH displays the NetWare directory maps in the current context and their respective descriptions. The user can use the directory maps to change to both local and remote servers without having to know the location.

For example, SITE PATH XYZ* displays all directory maps in the current context beginning with XYZ.

- ◆ SERVER displays all NetWare servers in the current NDS context and their status if available.

For example, SITE SERVER XYZ* displays all NetWare servers in the current context beginning with XYZ.

- ◆ SLIST displays NetWare servers that are both identified in NDS and the bindery.

For example, SITE SLIST XYZ* displays all known NetWare servers beginning with XYZ.

AFTP Site Commands

During an FTP session when the user is active on an IBM host, the following SITE commands are available. The SITE commands are only active on the IBM host where they were executed.

ALLOC	<i>Allocate memory size</i>
BLOCK	<i>Block size</i>
LRECL	<i>Record length</i>
RECFM	<i>Record format</i>

Changing the Server Synchronization Interval

This section describes how to use UNICON to change the server synchronization interval. This global parameter is the only parameter that can be modified using the UNICON utility.

The following topics are discussed:

- ◆ “Using the Server Profile Screens” on page 285
- ◆ “Modifying the Synchronization Interval” on page 288

Using the Server Profile Screens

Change the synchronization interval using the following UNICON screens:

- ◆ Server Profile form
- ◆ Server Profile Configuration form

If you need information about a specific field on one of these screens, position the cursor in the field and press <F1>.

Server Profile Form

The Server Profile form displays information about the NetWare® NFS server. Use this form to review the current information about a server.

Displaying the Server Profile Form

To display the Server Profile form,

1. **Start at the UNICON Main Menu and make the following selection:**
 - ☞ **View Server Profile**
2. **Complete procedure and exit.**

Understanding the Server Profile Form

Server Profile	
Host IP Name:	sjf-argos
Primary IP Address:	123.45.6.7
Primary Subnet Mask:	255.255.252.0
NetWare Information:	<see form>
Time Zone:	PSTPDT
Synchronization Interval:	60 seconds
NIS Client Access:	<enabled>
Domain:	sjf-argos
Server:	<not assigned>
DNS Client Access:	<enabled>
Domain:	sjf-argos.com
Name Server #1:	123.45.6.7
Name Server #2:	<not assigned>
Name Server #3:	<not assigned>

This form contains the following fields:

Host IP Name—the IP name of the NetWare server. This field is display only.

Primary IP Address—the IP address of the NetWare server. This field is display only.

Primary Subnet Mask—the subnet mask which, when added to the IP address, provides the IP network number. This field is display only.

NetWare Information—displays the following information:

- ◆ **Operating System Version**—the version of the operating system being used by the host. This field is display only.
- ◆ **Current NDS Context**—the context or logical position of the server within the NDS™ tree.
- ◆ **Current NDS Tree**—the current NDS tree.

Time Zone—the world time zone reference for your area. The time zone is used to set time synchronization and for time stamps. The time zone reference is set during installation of NetWare.

Synchronization Interval—the interval (in seconds) after which the NetWare server checks the following files in the ETC directory for changes: NFSUSERS, NFSGROUP, and NLPARAMS. When a change is detected, the file is reread into memory. Valid values are integers from 1 to 1,000. The default value is 60 seconds.

For a description of the remaining fields, see “Managing the Network Information Service (NIS)” on page 208. You can also refer to *Novell DNS/DHCP Services Administrator’s Guide*.

Server Profile Configuration Form

The Server Profile Configuration form displays a subset of the information on the Server Profile form. Use this form to change the information.

1. **To display this form, start at the UNICON Main Menu and make the following selections:**

- ↳ **Manage Global Objects**
- ↳ **Configure Server Profile**

Server Profile Configuration	
Synchronization Interval:	60 seconds
NIS Client Access:	<enabled>
Domain:	sjf-argos
Server:	<not assigned>
DNS Client Access:	<enabled>
Domain:	sjf-argos.com
Name Server #1:	123.45.6.7
Name Server #2:	<not assigned>
Name Server #3:	<not assigned>

2. **Complete procedure and exit.**

Modifying the Synchronization Interval

Use this procedure to change the server synchronization interval.

1. **Start at the UNICON Main Menu and make the following selections:**

↳ **Manage Global Objects**

↳ **Configure Server Profile**

The utility displays the Server Profile Configuration form.

2. **Highlight the Synchronization Interval field, type in the new interval, and press <Enter>.**

3. **To return to the Main Menu, press <Esc> as many times as needed.**

The utility displays the Main Menu.

Managing Error Reporting and SNMP Alerts

This section describes how to manage error reporting. This product reports system errors to the local NetWare® Print Services for UNIX* server. You can also enable Simple Network Management Protocol (SNMP) to report errors to other servers on the network.

The following topics are discussed:

- ◆ “Managing Error Reporting” on page 289
- ◆ “Managing SNMP Reporting” on page 296

See the section on Error Messages for a list of the errors and their solutions.

Managing Error Reporting

The local error reporting system reports system errors to the local NetWare® Print Services for UNIX* server. You can choose what type of problems are reported and whether the messages are sent to the display, a log file, or both. The local system also reports SNMP errors, but only to the local server. You cannot manage remote nodes using the local error reporting system.

Using the Error Reporting Management Screens

Manage error reporting using the following UNICON screens:

- ◆ Configure Error Logging/SNMP Alert Levels form
- ◆ AUDIT.LOG file screen
- ◆ Product Kernel Message screen

If you need information about a specific field on one of these screens, position the cursor in the field and press <F1>.

Configure Error Logging/SNMP Alert Levels Form

Use the Configure Error Logging/SNMP Alert Levels form to select errors to monitor or record locally. Error messages issued by the error reporting system can be sent to the AUDIT.LOG file or the Product Kernel Message screen or both. You can also use this form to modify the size of the AUDIT.LOG file.

Displaying the Configure Error Logging/SNMP Alert Levels Form

To display the Configure Error Logging/SNMP Alert Levels form,

1. **Start at the UNICON Main Menu and make the following selections:**
 - ↳ **Configure Error Reporting**
 - ↳ **Configure Error Logging/SNMP Alert Levels**

Configure Error Logging/SNMP Alert Levels	
Product Kernel Screen Error Level:	Warning
Audit Log Error Level:	Error
Maximum Size of the Audit Log:	10240
SNMP Alert Level:	Major

2. **Complete procedure and exit.**

Understanding the Configure Error Logging/SNMP Alert Levels Form

This form contains the following fields:

Product Kernel Screen Error Level—the level of error messages sent to the console screen. The default is Error. Select this field to display a list of error levels (described below). You can also turn off error reporting from this list.

The error reporting levels are:

- ◆ None—suppresses error reporting.
- ◆ Error—notifies you about a critical problem or likely failure.
- ◆ Warning—notifies you about a potential problem that could lead to failure if nothing is done.

- ◆ Informational—provides descriptive information.
- ◆ Debug—provides detailed information that Novell's technical support staff can use to evaluate a problem.

Each level incorporates the information in the levels listed above it. For example, if you choose Informational, you also receive warnings and errors.

Audit Log Error Level—the level of error messages written to the AUDIT.LOG file. Select this field to display a list of error levels (described above).

Maximum Size of the Audit Log—the maximum size of the audit file. The default is 10,240 bytes. The maximum size is 262,144 bytes. After the file fills up, new messages overwrite the older messages in the file.

SNMP Alert Level—the SNMP alarms (called *alerts* in this product) reported to SNMP management stations. Select this field to display a list of alert levels. The alerts are described in “SNMP Alert Levels” under “Understanding the Configure Error Logging/SNMP Alert Levels Form” on page 299. When you have not enabled SNMP reporting, SNMP errors are reported only through the local reporting system. For more information on local reporting of SNMP errors, see “Defining SNMP Reporting for the NetWare UXPS Server” on page 302.

AUDIT.LOG File

The AUDIT.LOG file records error messages of the selected level.

1. To display this file, start at the UNICON Main Menu and make the following selections:

➤ Configure Error Reporting

➤ Display Audit Log

```
sys:/etc/audit.log
4-04-94 12:11:56pm YPXFR-Error:
    cannot get master of sjf-janaZ netid.byname. Reason: Cannot bind to a server
    which serves domain
4-04-94 12:11:56pm YPXFR-Error:
    YPXFR : hostname argument is bad.
4-04-94 12:12:00pm YPXFR-Error:
    cannot get master of sjf-janaZ nfshosts.byDNSname. Reason: Cannot bind to a
    server which serves domain
4-04-94 12:12:00pm YPXFR-Error:
    YPXFR : hostname argument is bad.
4-04-94 12:12:20pm YPXFR-Error:
    cannot get master of sjf-janaZ nfshosts.byDNSname. Reason: Cannot bind to a
    server which serves domain
4-04-94 12:12:20pm YPXFR-Error:
    YPXFR : hostname argument is bad.
4-04-94 12:12:32pm YPXFR-Error:
    cannot get master of sjf-janaZ id.byToken. Reason: Cannot bind to a server
```

2. Complete procedure and exit.

Product Kernel Message Screen

The Product Kernel Message screen displays on the server console. It displays messages related to the operation of active NetWare services, as well as error messages issued by the error reporting system.

To display this screen, start at any of the UNICON screens, hold down <Alt>, and press <Esc> twice. To return to UNICON, hold down <Alt> and press <Esc>.

```
----- Product Kernel Message Screen -----  
  
cannot get master of sjf-argos hosts.byname. Reason: Cannot bind to a server  
which serves domain  
4-04-94 1:14:08pm VPKFR-Error:  
VPKFR : hostname argument is bad.  
  
4-04-94 1:14:20pm VPKFR-Error:  
cannot get master of sjf-argos hosts.byaddr. Reason: Cannot bind to a server  
which serves domain  
4-04-94 1:14:20pm VPKFR-Error:  
VPKFR : hostname argument is bad.  
  
4-04-94 1:14:32pm VPKFR-Error:  
cannot get master of sjf-argos ypservers. Reason: Cannot bind to a server  
which serves domain  
4-04-94 1:14:32pm VPKFR-Error:  
VPKFR : hostname argument is bad.  
  
4-04-94 1:14:33pm FTPSERV-Error:  
Intruder Alert. 8 unsuccessful logins from sjf-argos2  
4-04-94 1:14:45pm VPKFR-Error:  
cannot get master of sjf-argos passwd.byname. Reason: Cannot bind to a  
server which serves domain
```

Configuring Error Reporting

Use this procedure to configure error reporting:

1. **Start at the UNICON Main Menu and make the following selections:**

➤ **Configure Error Reporting**

➤ **Configure Error Logging/SNMP Alert Levels**

The utility displays the Configure Error Logging/SNMP Alert Levels form described in “Configure Error Logging/SNMP Alert Levels Form” on page 289.

2. **Select Product Kernel Screen Error Level.**

The utility displays the list of error levels.

3. **Select the type of messages you want reported to the console.**

The utility displays the Configure Error Logging/SNMP Alert Levels form.

4. Select Audit Log Error Level.

The utility displays the list of error levels.

5. Select the type of messages you want written to the AUDIT.LOG file.

The utility displays the Configure Error Logging/SNMP Alert Levels form.

6. Highlight the Maximum Size of the Audit Log field. Type in the number of the bytes and press <Enter>.

The form displays the new value.

7. To exit the Configure Error Logging Levels form, press <Esc>.

The utility displays the Configure Error Reporting menu.

8. To return to the Main Menu, press <Esc>.

The utility displays the Main Menu.

Viewing the AUDIT.LOG File

Use this procedure to display the AUDIT.LOG file:

1. Start at the UNICON Main Menu and make the following selections:

↳ **Configure Error Reporting**

↳ **Display Audit Log**

The utility displays the AUDIT.LOG file described in “AUDIT.LOG File” on page 292.

2. Press <Esc>.

The utility displays the Configure Error Reporting menu.

3. To return to the Main Menu, press <Esc>.

The utility displays the Main Menu.

Backing Up the AUDIT.LOG File

Note: You cannot save or append the AUDIT.LOG file to an existing file.

Use this procedure to back up the AUDIT.LOG file:

1. **Start at the UNICON Main Menu and make the following selections:**

- ↳ **Configure Error Reporting**
- ↳ **Save Audit Log**

The utility prompts you for the name of the file in which to save the audit log.

2. **Enter the full path of the file.**

The utility saves the audit log file, then redisplay the Configure Error Reporting menu.

3. **Press <Esc>.**

The utility displays the Main Menu.

Deleting the Contents of the AUDIT.LOG File

Note: When you select the Clear Audit Log option and press <Enter>, the system erases the contents of the audit log immediately. You may want to back up the audit log before you clear it.

Use this procedure to clear the AUDIT.LOG file:

1. **Start at the UNICON Main Menu and make the following selections:**

- ↳ **Configure Error Reporting**
- ↳ **Clear Audit Log**

The utility deletes the file and displays a confirmation message.

2. **Press <Enter>.**

The utility displays the Configure Error Reporting menu.

3. To return to the Main Menu, press <Esc>.

The utility displays the Main Menu.

Clearing the Product Kernel Message Screen

Use this procedure to clear the Product Kernel Message screen:

1. Start at the UNICON Main Menu and make the following selections:

↳ Configure Error Reporting

↳ Clear Product Kernel Screen

The utility clears the screen and displays a confirmation message.

2. Press <Enter>.

The utility displays the Configure Error Reporting menu.

3. To return to the Main Menu, press <Esc>.

The utility displays the Main Menu.

Managing SNMP Reporting

SNMP enables you to manage distributed network nodes from a central location, called an SNMP *management station*. From the SNMP management station, you can view the following types of information about the nodes:

- ◆ Performance statistics
- ◆ Event activity alarms (called *alerts* in this product)

An alarm indicates the occurrence of a network event at a node managed by SNMP. The event causes a type of message called a *trap* to be sent to the SNMP management station. For example, SNMP might send a cold start trap to the management station immediately after a node starts up.

The following sections describe how to set up and manage SNMP reporting on a NetWare Print Services for UNIX server.

Using the SNMP Management Screens

Manage SNMP reporting using the following screens:

- ◆ SNMP Manager Table
- ◆ Configure Error Logging/SNMP Alert Levels form
- ◆ SNMP alert thresholds form

If you need information about a specific field on one of these screens, position the cursor in the field and press <F1>.

SNMP Manager Table

Use the SNMP Manager Table to identify which server is the SNMP management station. The NetWare server then directs the SNMP messages to the management station.

Displaying the SNMP Manager Table

To display the SNMP Manager Table,

1. **At the server console, type the following command:**

```
load inetcfg <Enter>
```

The INETCFG utility loads and displays the Internetworking Configuration menu.

2. **Make the following selections:**

⇨ **Protocols**

⇨ **TCP/IP**

The utility displays the TCP/IP Protocol Configuration form.

3. **Select the SNMP Manager Table field and press <Enter>.**

The utility displays the SNMP Manager Table.

SNMP Manager Table
190.57.7.87

Understanding the SNMP Manager Table

The table identifies the SNMP management stations to which the NetWare server currently sends messages. You can specify an SNMP manager by pressing <Insert> and typing the name or address of the SNMP management station. To remove an SNMP management station, highlight the entry and press <Delete>.

Configure Error Logging/SNMP Alert Levels Form

Use the Configure Error Logging/SNMP Alert Levels form to set reporting levels for SNMP.

Displaying the Configure Error Logging/SNMP Alert Levels Form

To display the Configure Error Logging/SNMP Alert Levels form,

1. **Start at the UNICON Main Menu and make the following selections:**
 - ↳ **Configure Error Reporting**
 - ↳ **Configure Error Logging/SNMP Alert Levels**

Configure Error Logging/SNMP Alert Levels	
Product Kernel Screen Error Level:	Warning
Audit Log Error Level:	Error
Maximum Size of the Audit Log:	10240
SNMP Alert Level:	Major

2. **Complete procedure and exit.**

Understanding the Configure Error Logging/SNMP Alert Levels Form

This form contains one field pertaining to SNMP reporting levels. The other fields are described in “Understanding the Configure Error Logging/SNMP Alert Levels Form” on page 290.

SNMP Alert Levels—the level of SNMP alerts reported to SNMP management stations. Select this field to display a list of alert levels. You can also turn off SNMP reporting from this list.

The SNMP alert levels are:

- ◆ **None**—suppresses SNMP reporting.
- ◆ **Critical**—warns you about urgent problems that require immediate action to prevent widespread failure.

- ◆ Major—warns you about serious problems that require prompt action to prevent failure of the object and possibly some related objects.
- ◆ Minor—provides information about problems that can be addressed as work schedules permit.
- ◆ Informational—provides descriptive information that can be used for such things as trend analysis and planning.

Each level incorporates the information in the levels listed above it. For example, if you choose Minor, you also receive messages about Major and Critical alerts.

SNMP Alert Thresholds Form

The SNMP alert thresholds form displays the current thresholds for triggering SNMP alerts.

Displaying the SNMP Alert Thresholds Form

To display the SNMP alert thresholds form,

1. **Start at the UNICON Main Menu and make the following selection:**

- ↳ **Manage Services**
 - ↳ **UXPS Server**
 - ↳ **Configure SNMP Thresholds**

SNMP Event	Threshold	Level
Alert if Open File Cache Utilization Exceeds	40 %	Major
Alert if Request Cache Utilization Exceeds	50 %	Major
Alert if UDP Receive Queue Utilization Exceeds	60 %	Major

2. **Complete procedure and exit.**

Understanding the SNMP Alert Thresholds Form

This form contains the following fields:

Alert if Open File Cache Utilization Exceeds—defines the threshold for sending an SNMP alert when open file cache exceeds a certain percentage (the default value is 40 percent).

Alert if Request Cache Utilization Exceeds—defines the threshold for sending an SNMP alert when requests for cache exceed a certain percentage (the default value is 50 percent).

Alert if UDP Receive Queue Utilization Exceeds—defines the threshold for sending an SNMP alert when receive queue utilization exceeds a certain percentage (the default value is 60 percent).

Setting Up SNMP Alarm Reporting

You can use SNMP to monitor events that occur on your NetWare UXPS servers. If you plan to use SNMP to monitor NetWare UXPS events, you must

- ◆ Identify an SNMP management station to receive trap messages for each node
- ◆ Define the SNMP alert level

Identifying an SNMP Management Station

To identify an SNMP management station to receive traps for a node, add the management station's name or address to the node's `SYS:/ETC/TRAPTARG.CFG` file. To edit the file, use the InterNetworking Configuration (INETCFG) utility. You can identify more than one management station.

Use the following procedure to specify an SNMP management station:

1. Make the following selections:

- ☞ **Protocols**
- ☞ **TCP/IP**

The utility displays the TCP/IP Protocol Configuration form.

2. Select the SNMP Manager Table field.

The utility displays the SNMP Manager Table described in “SNMP Manager Table” on page 297.

3. To add the name or address of the destination SNMP management station, press <Insert>.

The utility prompts you for the name or address of the SNMP management station.

4. Type the name or address of the SNMP management station and press <Enter>.

The utility displays the name or address of the SNMP management station you specified on the SNMP Manager Table.

5. To save your entry, press <Esc>.

The utility displays a confirmation box.

6. To save your changes, select Yes.

The utility displays the TCP/IP Configuration form.

7. To exit the INETCFG utility, press <Esc> three times.

The utility displays a confirmation box.

8. To return to the server console prompt, select Yes.

The INETCFG utility unloads.

Defining SNMP Reporting for the NetWare UXPS Server

The NetWare UXPS server sends SNMP alarms (called alerts in this product) to the SNMP management stations that are configured to receive them. The NetWare UXPS server also incorporates all SNMP events into its error reporting system, to be displayed on the Product Kernel Message Screen or logged to the AUDIT.LOG file along with other system error reporting messages.

The alerts are automatically assigned local error reporting levels, even when SNMP reporting levels are set to None. The local error reporting system converts each SNMP alert as follows:

SNMP Reporting Level	Error Reporting System Level
Critical	Error
Major	Error
Minor	Warning
Informational	Informational

Use the following procedure to define SNMP reporting for the NetWare UXPS Server:

- 1. Start at the UNICON Main Menu and make the following selections:**

- ↳ **Configure Error Reporting**

- ↳ **Configure Error Logging/SNMP Alert Levels**

The utility displays the Configure Error Logging/SNMP Alert Levels form described in “Configure Error Logging/SNMP Alert Levels Form” on page 289.

- 2. Select the SNMP Alert Level field.**

The utility displays a list of SNMP error levels.

- 3. Select the level that you want reported to SNMP management stations or None to turn off SNMP reporting.**

The utility displays the Configure Error Logging/SNMP Alert Levels form.

- 4. To exit the Configure Error Logging Levels form, press <Esc>.**

The utility displays the Configure Error Reporting menu.

- 5. To return to the Main Menu, press <Esc>.**

The utility displays the Main Menu.

Setting Alert Thresholds

Use this procedure to reset threshold levels for SNMP alerts:

1. **Start at the UNICON Main Menu and make the following selection:**

- ↳ **Manage Services**

- ↳ **UXPS Server**

- ↳ **Configure SNMP Thresholds**

The utility displays the SNMP Alert Threshold form described in “SNMP Alert Thresholds Form” on page 300.

2. **Change the alert threshold levels as necessary.**
3. **To exit the form, press <Esc>.**
The utility displays a confirmation box.
4. **Select Yes to save your changes or No to exit without saving your changes.**
The utility displays the UXPS Server Administration menu.
5. **To return to the Main Menu, press <Esc> twice.**

The utility displays the Main Menu.

Managing Remotely

You can manage a NetWare® server remotely from a DOS workstation, another NetWare server, a machine running an X Window System* client or a UnixWare™ client, or a VT100*/VT220 terminal.

This section discusses the following topics:

- ◆ “Managing a NetWare Server Using RCONSOLE” on page 305
- ◆ “Managing a Different NetWare Server Using UNICON” on page 305
- ◆ “Managing a Netware Server Using XConsole” on page 308
- ◆ “Using Keyboard Functions” on page 315

Managing a NetWare Server Using RCONSOLE

Use the RCONSOLE utility to manage a NetWare® server from a DOS workstation. After accessing the NetWare console via RCONSOLE, you can use UNICON to log in to another server and manage multiple servers from one console. The following section describes how to use UNICON to log in to another server.

RCONSOLE is included with NetWare. For more information on the RCONSOLE utility, refer to the documentation for NetWare 5.

Managing a Different NetWare Server Using UNICON

You can use UNICON to log in to any server that is running NetWare® UXPS software or any other software that is UNICON compatible. This allows you to administer multiple servers from one console.

Use the Server Login form to log in to another server.

Using the Server Login Form

The Server Login form provides a way to enter information the first time you log in to a server.

Displaying the Server Login Form

1. To display this form, start at the UNICON Main Menu and make the following selection.

➤ Change Current Server

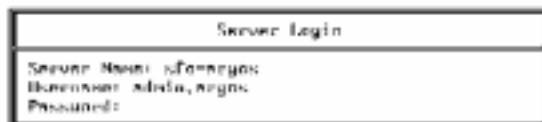

```
Server Login
Server Name: rfbrown
Username: admin, argos
Password:
```

The first time you use this option, the utility displays the Server Login form.

If you have used the utility to access other servers, it displays a list of the servers you are currently logged in to. To log in to a server not included on the list, press <Insert>. The utility displays the Server Login form.

2. Complete procedure and exit.

Understanding the Server Login Form

This form contains the following fields:

Server Name—the name or IP address of the server you want to log in to.

User Name—your user name. If you are logging in from a different context, use your complete name, such as .CN=RBROWN.OU=SALES.O=ARGOS. UNICON displays the context of the server in a box below the Server Login form.

Password—the password assigned to the user name you entered.

After you log in to a server, you stay logged in until you either use <Delete> to log out or quit UNICON.

Note: Before you can log in to a server using the server name, you must use UNICON to enter the server's IP address in the host table. For further instructions, see "Managing Host Information" on page 121 and "Managing Host Group Information" on page 133.

Logging in to Another Server

Use this procedure to log in to another server:

1. **Start at the UNICON *Main Menu* and make the following selection:**

➤ **Change Current Server**

The first time you use this option, the utility displays the Server Login form described in “Using the Server Login Form” on page 305.

If you have used the utility to access other servers, UNICON displays a list of servers that you are logged in to.

2. **Select the server to access.**

- 2a. **If the server you want to access is listed, highlight it and press <Enter>.**

The utility connects you to the selected server and displays the list of servers. The process continues with Step 4.

- 2b. **If the server you want to access is not listed, press <Insert>.**

The utility displays the Server Login form, which is described in “Using the Server Login Form” on page 305.

3. **Fill in the Server Login form.**

The utility connects you to the selected server and displays the list of servers. The new server appears in the list.

4. **To exit the list of servers, press <Esc>.**

The utility displays the Main Menu.

Managing a NetWare Server Using XConsole

XConsole allows you to administer the NetWare® server from an X terminal, a workstation that provides X terminal functionality (runs an X server), a VT100/VT220 terminal, or a terminal that provides exact VT100/VT220 terminal emulation.

XConsole runs on a NetWare file server. You can open a console session on the remote workstation and view the NetWare console display. You can perform any operation during the session that you could perform at the server console, except for restarting the server or XConsole module.

You can open multiple XConsole sessions to a single NetWare server and have each session show a different console screen. You can also open sessions to multiple NetWare servers simultaneously.

Using XConsole

To run XConsole, you must have the following NetWare Loadable Module™ (NLM™) programs installed and running on your NetWare server:

- ◆ The REMOTE NLM, which handles various NetWare screen drivers, including RSPX/RCONSOLE. The REMOTE NLM is part of the NetWare 3.x and NetWare 4.x/NetWare 5 software packages.
- ◆ The XCONSOLE NLM, which contains a simplified version of the TELNET server and the means to display the NetWare console screen as an X Window System screen or a VT100/VT220 screen. The XCONSOLE NLM is part of the NetWare NFS Gateway product.

Loading the XConsole Software

Load the REMOTE NLM from the NetWare console, if it is not already running, by typing

```
LOAD REMOTE <Enter>
```

Next, load the XCONSOLE NLM from the NetWare console, if it is not already running, by typing

```
LOAD XCONSOLE [s=sessions] [/24] <Enter>
```

Replace *sessions* with the number of XConsole sessions that the server can run concurrently (up to 64). The default value is 6.

If you load XConsole using the /24 option, the screen displays lines 2 through 25 of the NetWare server console on a 24-line terminal. Therefore, the first line is not displayed.

You can also start XConsole using the Start/Stop Services option of UNICON.

The following error message may appear in the audit log or on the Product Kernel Message screen when you try to establish a connection through XConsole:

```
XCONSOLE-Error: Fatal IO error(60),  
Connection timed out,  
on: hostname:0.0(1)
```

If you receive this message, check the version of the LAN driver you are using for your NetWare server. For example, if you are using a Western Digital LAN driver, you must have version 3.00 or later.

Providing Your Display and Screen Number

When you start an XConsole session, you are prompted to enter your display and screen numbers.

The X Window System defines a display as a monitor with its own separate keyboard or mouse. For example, if you have two monitors attached to a single computer, and each monitor has its own separate keyboard or mouse, you have two displays.

You can also have two monitors linked together with only one mouse, as shown in “Two X Window System Displays” on page 310 (Display 0 Screen 0 and Display 0 Screen 1 are controlled by the same mouse). In this case, you have one display but two screens. Or, one display can have more than one screen, such as a monitor that is switchable between monochrome and color. (See “One X Window System Display with Two Screens” on page 310 .)

Each workstation display is numbered consecutively beginning with zero. Each screen is also numbered consecutively.

Figure 4-1
Two X Window System Displays

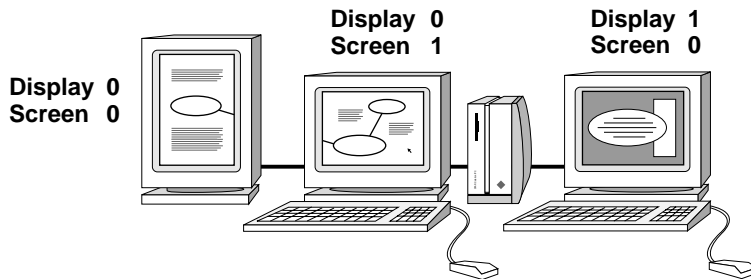
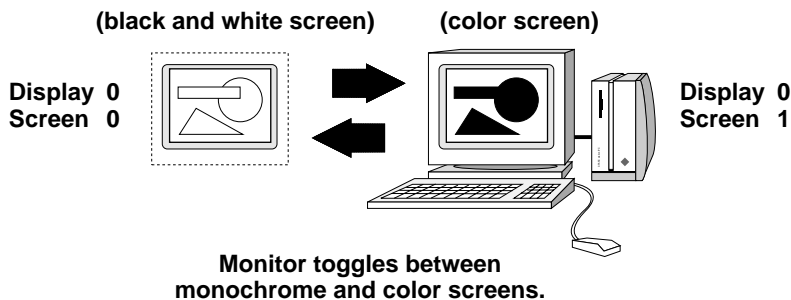

Figure 4-2
One X Window System Display with Two Screens



Starting and Ending an XConsole Session Using X Windows

Use this procedure to start and end an XConsole session:

- 1. Start the window manager on your workstation.**

You can run XConsole without a window manager, if you prefer. The session is displayed in a window, but you will not be able to manipulate the window.

- 2. Give the NetWare file server rights to send data to the workstation display by typing**

```
xhost servername <Enter>
```

The `xhost` command adds the NetWare file server *servername* to the workstation's X-server access-control list. To allow all hosts to write to the display, type a plus sign (+) in place of *servername*.

Note: Before you disable access control and allow all hosts, evaluate the potential security risk.

- 3. Connect to the NetWare server running XConsole by typing**

```
telnet servername <Enter>
```

Depending on your terminal type, there may be several terminal services available. If there is more than one available service, telnet prompts you to select the service type.

For example, if your terminal type is set to VT100/220, there are two services available and the following prompt appears:

```
[Select one of the following Telnet Services]
1- X11 Console Session to the NetWare Server
2- VT220 Console Session to the NetWare Server

-----
Help is Ctrl-? or Ctrl-w
Exit is Ctrl-x
-----
```

- 4. If there is more than one terminal service available, TELNET prompts you to select the appropriate service. Enter the appropriate number to choose an X Window terminal type.**

The TELNET connection prompts you for a password.

5. **Enter either the remote console password or the password for the server's SUPERVISOR account.**

When you enter the correct password, the following prompt appears:

```
Do you want the X-session displayed
on a display other than the default
[local host IP address:0.0] (y/n)? [n]
```

6. **Respond to the display prompt.**
 - 6a. **If you want to display the session on the default display, accept the default response (*No*) by pressing <Enter>.**

The process continues with the response to Step 8.

- 6b. **If your computer has more than one display or screen, and you want to display the session on a display other than the default, enter Y for Yes.**

NetWare prompts for the host name:

```
Enter the name of the host where
XConsole should start the
X-session [host:0.0]:
```

7. **Press <Enter> to accept the default (local) host or type the appropriate host name or IP address and press <Enter>.**

NetWare prompts for your display and screen number:

```
Enter display number [0]:
Enter screen number [0]:
```

8. **Enter the appropriate display and screen number.**

A window displaying the server console opens on your display, and the following message is displayed before the TELNET connection closes:

```
XConsole session created successfully on host:x.x
```

9. **Activate the window and interact with the console from your keyboard as if you were at the server's console.**
10. **To open additional windows, repeat Step 3 through Step 8.**
11. **End the XConsole session as required by your window manager.**

Some window managers allow you to close the window to end the console session. If your window manager does not allow you to close the window, select the window and press <Ctrl-X> to end the session.

Troubleshooting an X Session

If an X server cannot establish a session with XConsole, the following error message may appear on your screen:

```
Cannot open X display, possible cause:
```

1. NetWare host is not authorized to use this X display, or
2. X server is not installed properly, or
3. This is not an X display

If you receive this message, make sure your workstation is running a true X terminal remote client. Then repeat Step 2.

Starting and Ending a VT100/VT220 XConsole Session

XConsole provides remote console operations from VT100/VT220 terminals and terminals that provide exact VT100/VT220 terminal emulation.

To use VT100 /VT220 emulation on a Sun workstation, run the xterm program instead of running the command or shell tools.

Use this procedure to start and end a VT100/VT200 XConsole session:

1. Connect to the NetWare server running XConsole by typing

```
telnet servername <Enter>
```

Depending on your terminal type, there may be several terminal services available. If there is more than one available service, telnet prompts you to select the service type.

For example, if your terminal type is set to VT100/220, there are two services available and the following prompt appears:

```
[Select one of the following Telnet Services]
1- X11 Console Session to the NetWare Server
2- VT220 Console Session to the NetWare Server

-----
Help is Ctrl-? or Ctrl-w
Exit is Ctrl-x
-----
```

2. If there is more than one terminal service available, TELNET prompts you to select the appropriate service. Enter the appropriate number to choose a VT100/220 terminal type.

The TELNET connection prompts you for a password.

3. Enter the remote console password or the password for the server's SUPERVISOR account.

After you enter the correct password, you can interact with the console using your keyboard as if you were at the server's console.

4. To end the session, press <Ctrl-X>.

Note: When using VT100/VT220 emulation mode, you may need to use the control key functions listed in "Using the Control Key for Special Key Substitution" on page 315.

Using Keyboard Functions

Certain keys can be used in an X Window or VT100/220 session to control the screen. For example, you can apply the keypad - (minus) key to display the previous screen. This section provides instructions for substituting other keys and for modifying your keyboard mapping in case your keyboard does not have the appropriate function keys.

Using the Control Key for Special Key Substitution

NetWare maps keyboard functions to the IBM PC Enhanced 101-key keyboard. However, XConsole supports an additional set of key functions based on use of the left Ctrl key.

Table 4-2 on page 315 shows the functions mapped to various <Ctrl> key combinations. The key combinations are not case sensitive.

Table 4-2
Key Functions Supported By XCONSOLE

Key Combination	Specialty key or function
<Ctrl-?>	Print XConsole control-key help page for X or VT100/220 mode
<Ctrl-w>	Print XConsole control-key help page for VT100/220 mode
<Ctrl-a>	<Alt>
<Ctrl-a><1>	<F1>
<Ctrl-a><2>	<F2>
<Ctrl-a><3>	<F3>
<Ctrl-a><4>	<F4>
<Ctrl-a><5>	<F5>
<Ctrl-a><6>	<F6>
<Ctrl-a><7>	<F7>
<Ctrl-a><8>	<F8>

Table 4-2

Key Functions Supported By XCONSOLE

Key Combination	Specialty key or function
<Ctrl-a><9>	<F9>
<Ctrl-a><a>	<F10>
<Ctrl-a>	<F11>
<Ctrl-a><c>	<F12>
<Ctrl-a><d>	<F13>
<Ctrl-a><e>	<F14>
<Ctrl-a>	<F15>
<Ctrl-b>	<Begin> (<Home>)
<Ctrl-d>	<Down-arrow>
<Ctrl-e>	<End>
<Ctrl-f>	Switch screen forward
<Ctrl-g>	<Delete>
<Ctrl-h>	<Backspace>
<Ctrl-l>	<Left-arrow>
<Ctrl-n>	<PageDown> (Next)
<Ctrl-o>	<Insert>
<Ctrl-p>	<PageUp> (Prior)
<Ctrl-r>	<Right-arrow>
<Ctrl-u>	<Up-arrow>
<Ctrl-x>	<Exit> (Quit session)
<Ctrl-z>	Select a screen
<Ctrl-[>	<Esc>
Plus (+ on numeric keypad)	Next screen

Table 4-2

Key Functions Supported By XCONSOLE

Key Combination	Specialty key or function
Minus (- on numeric keypad)	Previous screen

Using the Modifier Keys to Substitute for Function Keys

XConsole recognizes the following modifier keys:

- ◆ Left Shift
- ◆ Left Ctrl
- ◆ Left Alt
- ◆ Right Shift
- ◆ Right Ctrl
- ◆ Right Alt

Left <Shift>, Left <Ctrl>, and Right <Shift> are X Window System defaults and are preset in the keyboard modifier map. You can add the other three keys (Left <Alt>, Right <Ctrl>, and Right <Alt>) to the modifier map using the X utility *xmodmap*.

Adding the Modifier Keys

Add Right <Ctrl> to *xmodmap* as modifiername Control. Add Left <Alt> or Right <Alt> as modifiernames Mod 1, Mod 2, Mod 3, Mod 4, or Mod 5.

For example, to add Left <Alt> as Mod 1, type

```
xmodmap -e "add Mod1 = Alt_L" <Enter>
```

Refer to your X Window System documentation for additional information.

Using the Modifier Keys

You can use <Alt> in combination with hexadecimal equivalent keys 1 through 9 and a through f to substitute for function keys. Use <Alt> as modified by xmodmap (as described above) or use the substitute <Alt> key (<Ctrl-a>) combination. Table 4-3 on page 318 shows the possible combinations. The combinations are not case sensitive.

To use the <Ctrl-a> key combination, press and hold <Ctrl>, press <a>, release both keys, and then press the hexadecimal equivalent key. To use the <Alt> combinations, press <Alt> and the hexadecimal equivalent key simultaneously.

Table 4-3
<Alt> key combinations supported by XCONSOLE

Function key	Ctrl Key (VT100/220, X-terminal)	Modified Alt Key (X terminal only)
<F1>	<Ctrl-a><1>	<Alt-1>
<F2>	<Ctrl-a><2>	<Alt-2>
<F3>	<Ctrl-a><3>	<Alt-3>
<F4>	<Ctrl-a><4>	<Alt-4>
<F5>	<Ctrl-a><5>	<Alt-5>
<F6>	<Ctrl-a><6>	<Alt-6>
<F7>	<Ctrl-a><7>	<Alt-7>
<F8>	<Ctrl-a><8>	<Alt-8>
<F9>	<Ctrl-a><9>	<Alt-9>
<F10>	<Ctrl-a><a>	<Alt-a>
<F11>	<Ctrl-a>	<Alt-b>
<F12>	<Ctrl-a><c>	<Alt-c>
<F13>	<Ctrl-a><d>	<Alt-d>
<F14>	<Ctrl-a><e>	<Alt-e>
<F15>	<Ctrl-a><f>	<Alt-f>

Removing the NetWare Print Services for UNIX Software

This section explains how to remove the product software from a NetWare® server.

This section discusses the following topics:

- ◆ “Stopping the NetWare Print Services” on page 319
- ◆ “Unloading NLM Files” on page 320
- ◆ “Removing the Print Services Software” on page 320

Stopping the NetWare Print Services

Before you can remove the product software, stop all running UXPS services.

Use this procedure to stop all running UXPS services:

1. **Start at the UNICON *Main Menu* and make the following selection:**
 - **Start/Stop Services**

The utility displays the Running Services list.
2. **Highlight any running service and press <Delete>.**

The utility displays a confirmation box.
3. **Select Yes.**

The utility displays the Running Services list. The service you selected has been removed from the list.
4. **Repeat Steps 2 and 3 for each running UXPS service in the list.**
5. **After you stop all running services, press <Esc> to return to the Main Menu.**

The utility displays the Main Menu.

Unloading NLM Files

Note: Because you can unload an NLM file required by another NetWare product, make sure you remove the NetWare UXPS software at a time that does not inconvenience other NetWare users. After you remove the UXPS software, use the NetWare UNISTART command to reload the NLM files.

Use this procedure to unload all loaded NLM files:

1. **Type the following command at the console prompt:**

```
UNISTOP <Enter>
```

All UXPS services stop running.

2. **Complete procedure and exit.**

Removing the Print Services Software

Use this procedure to remove the product software from the server:

1. **Start the NWCONFIG utility from the console prompt by typing**

```
NWCONFIG <Enter>
```

The installation program displays the Select an Installation Method menu.

2. **Make the following selections:**

↳ **Product options**

↳ **View/Configure/Remove installed products**

The installation program displays a list of the currently installed products.

3. **Highlight the UXPS product entry and press <Delete>.**

The installation program displays a confirmation box.

4. Select Yes.

The installation program removes the selected software and displays the list of currently installed products. The UXPS entry is no longer on the list.

5. To quit the installation program, press <Esc> until the Exit INSTALL? prompt appears.

6. Select Yes to exit the installation program or No to choose another installation option.

If you select Yes, the installation program exits and returns you to the console prompt.

A Administration Procedures

This section contains information to help you configure a UNIX* system to function with NetWare®. The step-by-step procedures are intended for NetWare administrators who have little or no UNIX experience.

This section provides information for completing the following tasks:

1. Determining whether the UNIX host is using an NIS or DNS database to store information
Important: The tasks included in this appendix assume your UNIX host is NOT storing host, user, and group information in DNS and NIS databases. If your system uses either of these databases and you need further assistance, consult with the database administrator to obtain the information you need.
2. Making the UNIX host aware of your NetWare server's host name and IP address
3. Creating UNIX user accounts for NetWare users
4. Creating UNIX groups for NetWare groups
5. Exporting portions of the UNIX file system that authorize NetWare server access
6. Mounting portions of the NetWare file system that authorize NFS client access
7. Printing from UNIX workstations to NetWare printers
8. Allowing NetWare users to print to UNIX printers

AIX Administration Procedures

This section assumes you are using the IBM* AIX* v3.x or later. Earlier versions may not contain the functionality described in the following section.

Complete the following procedures as necessary:

- ◆ “Determining if NIS Is in Use on AIX” on page 325
- ◆ “Obtaining User, Group, and Host Information from NIS on AIX” on page 325
- ◆ “Determining if DNS is in Use on AIX” on page 326
- ◆ “Logging in as Root on AIX” on page 326
- ◆ “Identifying Your NetWare Server for AIX” on page 327
- ◆ “Finding Information About a User on AIX” on page 327
- ◆ “Creating a User Account and Setting a Password on AIX” on page 329
- ◆ “Finding Information About Groups on AIX” on page 331
- ◆ “Creating an AIX Group” on page 331
- ◆ “Exporting a File System from an NFS Server” on page 333
- ◆ “Mounting a File System from AIX Machine” on page 334
- ◆ “Printing on AIX” on page 336

Determining if NIS Is in Use on AIX

To determine if your AIX system is using NIS, enter the following command:

```
ypwhich <Enter>
```

If the command returns a domain name, the system is using NIS to store user and group information. If the command returns a message similar to the following:

```
ypwhich: host not running ypbind
```

or

```
ypwhich: the domainname hasn't been  
set on this machine the system is  
storing user and group information  
in local files.
```

Obtaining User, Group, and Host Information from NIS on AIX

If your system is using NIS and you want your NetWare® server to use (point to) the NIS database on the UNIX* host, enter the NIS domain name and server address in the appropriate fields of the Server Profile form. For more information on using a non-NetWare NIS server, see “Managing the Network Information Service (NIS)” on page 208.

If your system is using NIS and you want to transfer user, group, and host information from the AIX* machine to the NetWare server, you must first create files from the NIS database. The following commands create these files:

```
ypcat hosts > hosts <Enter>  
ypcat passwd > passwd <Enter>  
ypcat group > group <Enter>
```

You can now transfer the files to the NetWare server using the UNICON utility's FTP function (see “Copying a File from a Remote Host” on page 240).

When the files are larger than 64 KB, you cannot use the edit file function available through UNICON to edit unwanted entries. If any of your files are too large, use a DOS editor or remove the unwanted entries before you transfer the file from the AIX system to the NetWare server.

Determining if DNS is in Use on AIX

To determine if your AIX* system is using DNS to store host information, search for the `resolv.conf` file located in the `/etc` directory. If this file exists, your system is using DNS. Otherwise, your system is using a different method to store host information.

If your system is using DNS and you want your NetWare® server to use (point to) the DNS host database on the AIX host, enter the domain name and server address contained in the `resolv.conf` file in the appropriate fields of the Server Profile form.

Logging in as Root on AIX

Before you can perform an AIX* administration task, you must log in to the AIX host administration account (`root`). The following procedure assumes you have access to the AIX host's system console and the root password before you log in to the host.

1. **Log in to the AIX host as root by entering the following command:**

```
root <Enter>
```

The host prompts you for the root account's password.

2. **Type the password for the root account and press <Enter>.**

The host logs you in to the system as root and displays the command prompt.

Identifying Your NetWare Server for AIX

The AIX* host needs to know about other computers with which it communicates. Inform the AIX host of new computers by editing a file named `hosts`. This file is stored in the `/etc` directory.

The `hosts` file contains two information fields:

- ◆ The IP address field, which contains the host's IP address formatted as a series of four integers separated by periods
- ◆ The host name field, which contains the host's official name

The following example shows several entries from a `hosts` file:

```
192.53.4.1 tulip
192.53.3.6 chaos
192.53.5.12 newyork ny nyc
```

1. **Use an editor to open the AIX `hosts` file.**
2. **Create a new entry for the NetWare® server by typing the IP address, a space, and the server's hostname.**
3. **Save the edited `hosts` file and exit the editor.**

Finding Information About a User on AIX

For each NetWare® user accessing files through the NetWare server, you need to know both the user's user identification number (UID) and the group identification number (GID) of the user's primary login group.

This information is stored in the `passwd` file. This file is stored in the `/etc` directory. You can transfer the `passwd` file to the NetWare server using the UNICON utility's FTP function (see "Copying a File from a Remote Host" on page 240) or manually obtain the information for each user as described in the following sections.

Displaying User Information

To display a list of the current user accounts and UID numbers, use the following procedure:

1. **Start SMIT by entering the following command:**

```
smit <Enter>
```

The utility displays the Main Menu.

2. **From the Main Menu, make the following selections:**

➤ **Security and Users**

➤ **Users**

➤ **List All Users**

SMIT lists all user accounts, assigned UIDs, and login shell.

To obtain the user's primary GID, use the procedure in the following section, "Compiling a List of User Names with UIDs and Primary GIDs" on page 328.

Compiling a List of User Names with UIDs and Primary GIDs

If your AIX host has a large passwd file, you may want to create a file listing every user and the user's corresponding UID and GID. Create this list using the awk command.

The following example creates a file containing a three-column list of user names, UIDs, and GIDs. The list is stored in the host's /tmp directory.

```
awk '{FS=":";print $1,$3,$4}'  
/etc/passwd /tmp/userinfo <Enter>
```

The file created by the example contains a list that looks like this:

```
root 0 1  
nobody 65534 65534  
daemon 1 1  
bin 3 3  
joeuser 1848 720
```

Creating a User Account and Setting a Password on AIX

Use SMIT to create an account for a new user.

Each user account must have a unique UID. If an account already exists on another UNIX* machine, create the new account using the same UID and GID as on the existing system. To display a list of the current users and their UID numbers, refer to “Displaying User Information” on page 328.

Create User Form

When you create a user account using SMIT, you must supply the following information on the Create User form:

User NAME—the user name for the account.

User ID—the UID that you want to assign to the user.

PRIMARY group—the primary GID you want to assign to the user.

User Information—the user’s full name.

HOME Directory—the full path to the user’s home directory.

Initial PROGRAM—the full path and name of the shell that executes when the user logs in to the host (usually /bin/csh or /bin/sh).

Note: Although this form contains other fields, only those in the preceding list are necessary to create a new user. If you want further information about any of the other fields, highlight the field and press <F1>.

Creating a User Account

Use the following procedure to create a user account.

1. **Start SMIT by entering**

```
smit <Enter>
```

2. From the Main Menu, make the following selections:

↳ **Security and Users**

↳ **Users**

↳ **Add a User to the System**

The utility displays a form for adding new user information. Use the <Up-arrow> and <Down-arrow> keys to move through the form. Do not use <Enter> until you are finished and ready to exit the screen.

3. Fill in the appropriate fields of the Create User form (as listed in “Create User Form” on page 329) and press <Enter>.

The utility exits the form and creates the new user.

After you create a user, you need to add the user to the appropriate group(s). For instructions on adding a user to a group, see “Adding a Member to a Group” on page 332.

Setting the New User’s Password

Use the following procedure to set a new user’s password.

1. From the SMIT Main Menu, make the following selections:

↳ **Security and Users**

↳ **Change User Password**

The utility displays a form for entering the new user’s name.

2. Fill in the user name or use <F4> to highlight a user name and press <Enter>.

The utility displays the user name that you selected.

3. Press <Enter> to enter a new password.

The utility prompts you for the new password.

4. Type the new password and press <Enter>.

The system prompts you to reenter the password.

5. Reenter the password.

The system assigns the password when you exit the screen.

Finding Information About Groups on AIX

Each group defined on the AIX* host is listed in a file named `group`. This file is stored in the `/etc` directory. You can transfer the `group` file to the NetWare server using the UNICON utility's FTP function (see "Copying a File from a Remote Host" on page 240) or obtain the information for each group as described in the following procedures.

Each group must have a unique GID. To view a list of the current groups and GID numbers, use the following procedure:

1. Start SMIT by entering the following command:

```
smit <Enter>
```

The utility displays the Main Menu.

2. From the Main Menu, make the following selections:

- ↳ Security and Users
 - ↳ Groups
 - ↳ List All Groups

The utility displays a list of all the groups, their assigned GIDs, and a list of group members.

Creating an AIX Group

Information about AIX* groups is stored in the `/etc/group` file. To create a group, use SMIT.

Using SMIT to Create a Group

Use the following procedure to create a group.

1. **Start SMIT by entering the following command:**

```
smit <Enter>
```

The utility displays the Main Menu.

2. **From the Main Menu, make the following selections:**

↳ **Security and Users**

↳ **Users**

↳ **Add a Group to the System**

The utility displays a form for adding new group information.

3. **Type the group name in the Group Name field and press <Enter>.**

The group name must be eight characters or less.

The utility creates the new group, automatically assigns the next available GID, and exits the form.

Adding a Member to a Group

Use the following procedure to add a member to an existing group.

1. **Start SMIT by entering the following command:**

```
smit <Enter>
```

The utility displays the Main Menu.

2. **From the Main Menu, make the following selections:**

↳ **Security and Users**

↳ **Groups**

↳ **Change/Show Characteristics of a Group**

The utility displays a form in which you can type the name of a specific group.

3. **Either fill in the group name or use <F4> to highlight a group name and press <Enter>.**

The utility displays a form which provides the following:

Group NAME—the group name for the account.

Group ID—the Group Identification Number (GID).

User list—a list of users who are members of the group. Use <F4> to display a list of available users and <F7> to mark the users you want to add.

4. **Modify these fields as needed and press <Enter> to exit the form.**

The utility exits the form and any changes take effect.

Exporting a File System from an NFS Server

Before a NetWare® client can access a file system on an NFS server, you must provide the file system's mount path and identify which clients can access the files. Enter this information using SMIT.

Add a Directory to Exports List Form

Use SMIT to add a directory to the Exports List form. The form requires the following information:

PATHNAME—pathname of the directory to export.

MODE—read-write, read-only, or read-mostly.

HOSTS, root access—hosts permitted root access to the exported directory.

HOSTS & NETGROUPS, client access—hosts permitted client access to the exported directory. Enter the name of the NetWare server.

Note: Although this form contains other fields, only those in the preceding list are necessary to export a file system. If you want further information about any of the other fields, highlight the field and press <F1>.

Exporting the File System to AIX

Use the following procedure to export a file system.

1. **Start SMIT by entering the following command:**

```
smit <Enter>
```

The utility displays the Main Menu.

2. **From the Main Menu, make the following selections:**

↳ **Communication and Application Services**

↳ **NFS**

↳ **Network Filesystem**

↳ **Add a Directory to Exports List**

The utility displays a form for mounting a remote file system. Use the <Up-arrow> and <Down-arrow> keys to move through the form. Do not use <Enter> until you are finished and ready to exit the screen.

3. **Fill in the appropriate fields of the Add a Directory to Exports List form (as listed on “Add a Directory to Exports List Form” on page 333) and press <Enter>.**

The utility exits the form and exports the file system.

Mounting a File System from AIX Machine

Before an NFS user can access an exported NetWare® file system, you need to mount the NetWare file system from the AIX* NFS machine. Use SMIT to accomplish this task.

Adding a Directory to the Mount Form

Before you can mount a NetWare file system using SMIT, you must supply the following information on the Add a File System for Mounting form:

PATHNAME of mount point—the name of the empty directory you want to use as a mount point. If you use a directory that is not empty, the contents of that directory will be unavailable until you unmount the remote file system.

PATHNAME of remote directory—the name of the remote file system that you want to mount.

Note: Although this form contains other fields, only those in the preceding list are necessary to mount a file system. If you want further information about any of the other fields, highlight the field and press <F1>.

Mounting the File System

Use this procedure to mount a file system.

1. **Start SMIT by entering the following command:**

```
smit <Enter>
```

The utility displays the Main Menu.

2. **From the Main Menu, make the following selections:**

↳ **Communication and Application Services**

↳ **NFS**

↳ **Network Filesystem**

↳ **Add a File System for Mounting**

The utility displays a form for mounting a remote file system. Use the <Up-arrow> and <Down-arrow> keys to move through the form. Do not use <Enter> until you finish the form and want to exit the screen.

3. **Fill in the appropriate fields of the Add a File System for Mounting form (as listed on “Adding a Directory to the Mount Form” on page 335) and press <Enter>.**

The utility exits the form and mounts the file system.

Printing on AIX

The procedures in this section describe what to do at the UNIX* host to use NetWare® bidirectional printing.

UNIX-to-NetWare Printing

Remote computers supporting LPR protocol can send files to NetWare printers by using the UNIX-to-NetWare print service. In addition to setting up this print service, as described in the section on “Managing Print Services” on page 172, you need to configure your host machine.

Before you proceed, make sure the name and IP address of the NetWare server is listed in the `/etc/hosts` file on your AIX host.

AIX supports LPD. However, instead of using the `/etc/printcap` file for configuration, AIX uses SMIT to configure printing. To configure printing using SMIT, perform the following:

1. **Log in to the AIX host as root.**
2. **Start SMIT by entering the following command:**

```
smit <Enter>
```

3. **To add a remote print queue, select the following options from the SMIT menu:**

- ↳ **Spooler (Print Jobs and Printers)**
 - ↳ **Manage Remote Printer Subsystem**
 - ↳ **Client Services**
 - ↳ **Remote Printer Queues**
 - ↳ **Add a Remote Queue**

A form appears asking you to define a remote print queue.

4. **Enter information into the following fields. All other fields should use the default value.**

NAME of queue to add—the name of the local print queue. Print jobs sent to this queue are passed to the NetWare print queue. Enter a name of seven characters or less.

DESTINATION HOST for remote jobs—the name of the NetWare Server. This hostname must also be contained in the `/etc/hosts` file.

Name of QUEUE on remote printer—the name of the NetWare queue exported by using the `PLPDCFG.NLM`. Enter a name of seven characters or less.

NAME of device to add—a device name that is required by AIX but has no effect on the UNIX-to-NetWare print service. Enter any name of seven characters or less. The name does not need to be an existing device, nor does it need to be unique.

5. **Start the lpd subsystem with SMIT:**

- ☞ **Spooler (Print Jobs and Printers)**
- ☞ **Manage Remote Printer Subsystem**
- ☞ **Server Services**
- ☞ **lpd Remote Printer Subsystem**
- ☞ **Start Using the lpd Subsystem**
- ☞ **Start BOTH Now and at System Restart**

6. **Start the qdaemon by entering the following command:**

```
startsrc -s qdaemon <Enter>
```

7. **Try printing to the NetWare printer by issuing the following command:**

```
lpr -Pprinter filename <Enter>
```

8. **Examine the NetWare exported queue on the NetWare server by issuing the following command:**

```
lpq -Pprinter <Enter>
```

or

```
enq -q -Pprinter <Enter>
```

Troubleshooting

If you have any problems printing to a NetWare printer, try the following procedures.

1. Check the local QUEUE setup with SMIT as follows:

1a. Start SMIT by entering the following command:

```
smit <Enter>
```

1b. From the Main Menu, make the following selections:

- ↳ Spooler (Print Jobs and Printers)
- ↳ Manage Local Printers, Queues, and Queue Devices
- ↳ Manage Local Printer Subsystem
- ↳ Local Printer Queues
- ↳ Change / Show Characteristics of a Queue

1c. Highlight the name of the NetWare printer and press <Enter>.

1d. Check that the names assigned to the following items are correct:

- ◆ Current name of queue
- ◆ Destination Host for remote jobs
- ◆ Name of Queue on remote printer

2. Stop the local queue by entering the following command:

```
enq -Pprinter -D <Enter>
```

3. Restart the local queue by entering the following command:

```
enq -Pprinter -U <Enter>
```

4. Stop the lpd remote printer subsystem by entering the following command:

```
stopsrc -c -s lpd <Enter>
```

5. Restart the lpd remote printer subsystem by entering the following command:

```
startsrc -s lpd <Enter>
```

6. Verify that qdaemon is running by entering the following command:

```
lssrc -s qdaemon <Enter>
```

7. If Status is Active, continue with the next step. If Status is Inoperative, start qdaemon by issuing the following command:

```
startsrc -s qdaemon <Enter>
```

8. Check /usr/lpd/stat for device creation. You should see a file with a name similar to *s.device_name*.

9. Check /usr/lpd/qdir for queued files.

10. Check /usr/spool/qdaemon for temporarily spooled files.

11. Check /usr/lpd/qconfig for correct remote printer creation and configuration. You should see an entry in this file that looks like this:

```
printer_name:  
  device = lpdev  
  up = TRUE  
  host = NetWare_server_name  
  s_statfilter = /usr/lpd/bsdshort  
  l_statfilter = /usr/lpd/bsdlong  
  rq = NetWare_queue_for_export
```

Note: Only LP is fully implemented. Using QPRT will not support print control options such as Form Feed suppression.

NetWare-to-UNIX Printing

Before you proceed, ensure the following prerequisites are met.

- ◆ The name and IP address of the NetWare server are listed in the `/etc/hosts` file on your UNIX host.
- ◆ A NetWare user must have an account on the AIX system before the user can print to printers attached to AIX. Also, the AIX username must be the same as the corresponding lowercase, converted NetWare username. For example, if the AIX username is `milton`, the NetWare username is `MILTON`.

AIX supports LPD. Instead of using the `/etc/printcap` file for configuration, AIX uses SMIT to configure printing. To configure printing using SMIT, perform the following procedure:

1. **Start SMIT by entering the following command:**

```
smit <Enter>
```

2. **To add a local queue, select the following options from the SMIT menu:**

- ↳ **Spooler (Print Jobs and Printers)**
 - ↳ **Manage Local Printers, Queues, and Queue Devices**
 - ↳ **Manage Local Printer Subsystem**
 - ↳ **Local Printer Queues**
 - ↳ **Add a Local Queue**

A form appears asking you to define a local print queue.

3. **Enter information in the following fields. All other fields should use the default value.**

- ◆ **NAME of queue to add**—the name of the local print queue. This name was also assigned to the UNIX printer when you configured the NetWare-to-UNIX print gateway. The name must be seven characters or less.
- ◆ **NAME of device to add**—a device name for the local print queue. You should specify the local device connected to your local printer. The name must be seven characters or less: for example, `lp0`.

4. To specify the name of the NetWare server that will spool print jobs to your AIX host, select the following options from the SMIT menu:

- ↳ Spooler (Print Jobs and Printers)
 - ↳ Manage Remote Printer Subsystem
 - ↳ Server Services
 - ↳ Host Access for Printing
 - ↳ Add a Remote Host

You are prompted for the name of the remote host.

5. Type in the name of the NetWare server.
6. Try printing to the UNIX printer by entering the following command:

```
nprint filename /q=nw2unix /name=username
```

For *username*, use a valid login name on the AIX host.

Note: When printing to AIX printers from NetWare, you must specify the use of banners. This implies that you should not use the /NB option with either CAPTURE or NPRINT. Also, you should specify an AIX username with the /NAME= option when using CAPTURE or NPRINT. Otherwise, the print jobs will queue up on the AIX machine in the /usr/spool/qdaemon directory, but the lpq command will not show these jobs and they will not be printed.

Troubleshooting

If you have any problems printing to a NetWare printer, perform the following procedure at your AIX host.

1. Stop the local queue by entering the following command:

```
enq -Pprinter -D
```

2. Restart the local queue by entering the following command:

```
enq -Pprinter -U
```

3. **Stop the lpd remote printer subsystem by entering the following command.**

```
stopsrc -c -s lpd
```

4. **Restart the lpd remote printer subsystem by entering the following command**

```
startsrc -s lpd
```

5. **Stop the qdaemon by entering the following command.**

```
stopsrc -s qdaemon
```

6. **Restart the qdaemon by entering the following command:**

```
startsrc -s qdaemon
```

7. **Try the troubleshooting techniques in “Troubleshooting” on page 338 for configuring UNIX-to-NetWare printing.**

If you need additional help configuring the local printer subsystem using SMIT, consult your IBM* support representative.

HP-UX Administration Procedures

This section assumes you are using HP-UX* Release 9.0 or above. Earlier versions may not contain the functionality described in this section.

Complete the following procedures as necessary:

- ◆ “Determining if NIS is in Use on HP-UX” on page 344
- ◆ “Obtaining User, Group, and Host Information from NIS on HP-UX” on page 344
- ◆ “Determining if DNS is in Use on HP-UX” on page 345
- ◆ “Logging in as Root on HP-UX” on page 345
- ◆ “Identifying Your NetWare Server for HP-UX” on page 346
- ◆ “Finding Information About a User on HP-UX” on page 347
- ◆ “Compiling a List of User Names with UIDs and Primary GIDs on HP-UX” on page 348
- ◆ “Creating a User Account and Setting a Password on HP-UX” on page 348
- ◆ “Create User Form on HP-UX” on page 349
- ◆ “Creating a User Account on HP-UX” on page 349
- ◆ “Setting the New User’s Password on HP-UX” on page 350
- ◆ “Finding Information About Groups on HP-UX” on page 351
- ◆ “Creating a Group on HP-UX” on page 352
- ◆ “Adding a Member to a Group on HP-UX” on page 353
- ◆ “Exporting a File System in HP-UX” on page 354
- ◆ “Mounting a File System on HP-UX Machine” on page 356

- ◆ “Printing on HP-UX” on page 358

Determining if NIS is in Use on HP-UX

To determine if your HP-UX* system is using NIS, enter the following command:

```
ypwhich <Enter>
```

If the command returns a domain name, the system is using NIS to store user and group information. If the command returns messages similar to the following, then the system is storing user and group information in local files.

```
ypwhich: host not running ypbind
```

or

```
ypwhich: the domainname hasn't been set on this  
machine
```

Obtaining User, Group, and Host Information from NIS on HP-UX

If your system is using NIS and you want your NetWare® server to use (point to) the NIS database on the HP-UX* host, enter the NIS domain name and server address in the appropriate Server Profile fields. For more information on using a non-NetWare NIS server, see “Using a Non-NetWare Server as the NIS Master” on page 222 in the Managing section.

If your system is using NIS and you want to transfer user, group, and host information from your HP-UX host to the NetWare server, you must first create files from the NIS database. The following commands create these files:

```
ypcat hosts > hosts <Enter>  
ypcat passwd > passwd <Enter>  
ypcat group > group <Enter>
```

You can now transfer files to the NetWare server using the UNICON utility's FTP function (see "Copying a File from a Remote Host" on page 240).

When the files are larger than 64 KB, you cannot use the edit file function available through the UNICON utility to remove unwanted entries. If any of your files are too large, use a DOS editor or remove the unwanted entries before you transfer the file from the UNIX system to the NetWare server.

Determining if DNS is in Use on HP-UX

To determine if your HP-UX* system is using DNS to store host information, search for the `resolv.conf` file located in the `/etc` directory. If this file exists, your system is using DNS. Otherwise, your system is using a different method to store host information.

If your system is using DNS and you want your NetWare® server to use (point to) the DNS host database on the HP-UX host, enter the domain name and server address contained in the `resolv.conf` file in the appropriate fields of the Server Profile form.

Logging in as Root on HP-UX

Before you can perform any of the HP-UX* administration tasks listed in this section, you must log in to the HP-UX host administration account (`root`). The following procedure assumes you have access to the HP-UX host's system console and the root password before you log in to the host.

1. **Log in to the HP-UX host as root by entering the following command:**

```
root <Enter>
```

The host prompts you for the root account's password.

2. **Type the password for the root account and press <Enter>.**

The host logs you in to the system as root and displays the command prompt.

Important: All procedures in this section assume you are already logged in as root.

Identifying Your NetWare Server for HP-UX

The HP-UX* host needs to know about other computers with which it communicates. You inform the HP-UX host of new computers by editing a file named `hosts`. This file is stored in the `/etc` directory.

The hosts file contains two information fields:

- ◆ The IP address field, which contains the hosts's IP address formatted as a series of four integers separated by periods.
- ◆ The host name field, which contains the host's official name.

The following example shows several entries from a hosts file:

```
192.53.4.1 tulip
192.53.3.6 chaos
192.53.5.12 newyork ny nyc
```

Important: Your NetWare® server could have two names. The first name—which is specified in the `AUTOEXEC.NCF` file—is the name used by DOS, OS/2*, and Macintosh* users to connect to the server. The second name—which is specified in the server's hosts database—is the name used by the NetWare server. Use the name specified in the hosts database in the following procedure.

1. **Use an editor to open the HP-UX hosts file.**
2. **Create a new entry for the NetWare server by typing the IP address, a space, and the server's hostname.**
3. **Save the edited hosts file and exit the editor.**

Finding Information About a User on HP-UX

For each NetWare® user accessing NFS files through the NetWare server, you need to know the user's user identification number (UID) and the group identification number (GID) of the user's primary login group.

This information is stored in the passwd file. This file is stored in the /etc directory. You can transfer the passwd file to the NetWare server using the UNICON utility's FTP function (see "Copying a File from a Remote Host" on page 240) or manually obtain the information for each user as described in the following section.

Displaying User Information

To display a list of the current user accounts and UID numbers, use the following procedure:

1. **Start SAM (System Administration and Management) by entering the following command:**

```
sam <Enter>
```

The SAM utility displays the Main Menu.

2. **From the Main Menu, make the following selections:**

⇒ **Users and Groups**

⇒ **Users**

SAM lists all user accounts, assigned UIDs, and Primary Group.

To obtain the user's primary GID, use the procedure in the following section, "Compiling a List of User Names with UIDs and Primary GIDs on HP-UX" on page 348.

Compiling a List of User Names with UIDs and Primary GIDs on HP-UX

If your HP-UX* host has a large passwd file, you may want to create a file listing every user and the user's corresponding UID and GID. Create this list using the awk command.

The following example creates a file containing a three-column list of user names, UIDs, and GIDs. The list is stored in the host's /tmp directory.

```
awk '{FS=":";print $1,$3,$4}'  
/etc/passwd /tmp/userinfo <Enter>
```

The file created by the example contains a list that looks like this:

```
root 0 1  
nobody 65534 65534  
daemon 1 1  
bin 3 3  
joeuser 1848 720
```

Creating a User Account and Setting a Password on HP-UX

Use SAM to create an account for a new user.

Each user account must have a unique UID. If an account already exists on another UNIX* machine, create the new account using the same UID and GID as on the existing system. To display a list of the current users and their UID numbers, refer to "Displaying User Information" on page 347.

Create User Form on HP-UX

When you create a user account using SAM, you must supply the following information on the Create User form:

Login Name—the user name for the account.

User Identity (UID)—the UID that you want to assign to the user.

Home Directory—the full path to the user's home directory.

Primary Group Name—the primary GID you want to assign to the user.

Start-up Program—the full path and name of the shell that executes when the user logs in to the host (usually /bin/csh or /bin/sh).

Note: Although this form contains other fields, only those in the preceding list are necessary to create a new user. If you want further information about any of the other fields, highlight the field and press <F1>.

Creating a User Account on HP-UX

Use the following procedure to create a user account.

1. **Start SAM by entering**

```
sam <Enter>
```

2. **From the Main Menu, make the following selections:**

```
↳ Users and Groups
   ↳ Users
```

3. **Move to the SAM menu bar by pressing <F4>.**

4. **Make the following selections from the menu bar:**

```
↳ Actions
   ↳ Add
```

The utility displays a form for adding new user information.

5. Use the <Up-arrow> and <Down-arrow> keys to move through the form.

You can press <Enter> at fields where selection is involved to view the options available and then select one of the options.

6. Fill in the appropriate fields of the Create User form (as listed in “Create User Form on HP-UX” on page 349) and choose <OK>.

The utility displays the Password window.

7. Enter the password for this user and confirm it.

If you want this user to have no password, just press <Enter>.

After you create a user, you need to add the user to the appropriate group(s). For instructions on adding a user to a group, see “Adding a Member to a Group on HP-UX” on page 353.

Setting the New User’s Password on HP-UX

Use the following procedure to set a new user’s password.

1. From the SAM Main Menu, make the following selections:

- ↳ Users and Groups
 - ↳ Users

The utility displays the list of users and UIDs, etc.

2. Highlight the entry corresponding to the new user and select it by pressing <F3>.

3. Press <F4> to move to the menu bar.

4. Make the following selections from the menu bar:

- ↳ Actions
 - ↳ Modify

The utility displays the User details form with various fields.

5. Move to the Change Password field by pressing <Tab> until that field is highlighted.

6. **Press <Enter>.**

A Password Entry form is displayed.

7. **Enter the password and press <Enter>**

8. **Confirm it by reentering the password.**

9. **Move to the OK field and press <Enter>.**

The system assigns the password to the user.

Finding Information About Groups on HP-UX

Each group defined on the HP-UX* host is listed in a file named group. This file is stored in the /etc directory. You can transfer the group file to the NetWare® server using the UNICON utility's FTP function (see "Copying a File from a Remote Host" on page 240) or obtain the information for each group as described in the following procedures.

Each group must have a unique GID. To view a list of the current groups and GID numbers, use the following procedure:

1. **Start SAM by entering**

```
sam <Enter>
```

The utility displays the Main Menu.

2. **From the Main Menu, make the following selections:**

↳ **Users and Groups**

↳ **Groups**

The utility displays a list of all the groups with their assigned GIDs and group members.

Creating a Group on HP-UX

Use the following procedure to create a group.

1. Start SAM by entering

```
sam <Enter>
```

The utility displays the Main Menu.

2. From the Main Menu, make the following selections:

⇒ **Users and Groups**

⇒ **Groups**

The utility displays a list of all the groups, their assigned GIDs, and a list of group members.

3. Move to the menu bar by pressing <F4>.

4. Select

⇒ **Actions**

⇒ **Add**

The utility displays a form for adding a new group.

5. Type the group name in the Group Name field and press <Enter>.

6. Assign members to the group by selecting users from the list.

7. Move to the OK field and press <Enter>.

The utility creates the new group, automatically assigns the next available GID, and exits the form.

Adding a Member to a Group on HP-UX

Use the following procedure to add a member to an existing group.

1. **Start SAM by entering**

```
sam <Enter>
```

The utility displays the Main Menu.

2. **From the Main Menu, make the following selections:**

↳ **Users and Groups**

↳ **Groups**

The utility displays a list of all the groups, their assigned GIDs, and a list of group members.

3. **Highlight the group in which you want to add the user and select it by pressing <F3>.**

4. **Move to the menu bar by pressing <F4>.**

5. **In the menu bar, select**

↳ **Actions**

↳ **Modify**

Two lists appear. The first shows existing members of the group, and the second lists users who are not members of this group.

6. **In the non-members' window select the user to be added to the group.**

Use the <Up-arrow> and <Down-arrow> keys to highlight the user and press <Enter> to select that user.

7. **Press <a> to add the selected user to the group.**

Exporting a File System in HP-UX

Before a NetWare® client can access a file system on an NFS server, you must provide the file system's mount path and identify which clients can access the files. Enter this information using SAM.

Add a Directory to the Exports List Form

Use SAM to add a directory to the Exports List form. The form requires the following information:

Local Directory Name—pathname of the directory to export.

Permission for File Access—lists of servers permitted read-only, read-write, and/or root privileges to this exported directory.

Note: Although this form contains other fields, only those in the preceding list are necessary to export a file system. If you want further information about any of the other fields, highlight the field and press <F1>.

Exporting the File System

Use the following procedure to export a file system.

1. **Start SAM by entering**

```
sam <Enter>
```

The utility displays the Main Menu.

2. **From the Main Menu, make the following selections:**

```
↳ Networking/Communication
   ↳ Networked File Systems (NFS)
     ↳ Local Directories Exported
```

The utility displays a list of exported directories and a menu bar.

3. **Move to the menu bar by pressing <F4>.**

4. In the menu bar, make the following selections:

⇨ **Actions**

⇨ **Add**

The utility displays a form for adding a directory path for exporting.

5. Enter the complete directory path to be exported.

In the “Permission for File Access” field, SAM will display “No systems specified” next to each permission (read-only, read-write, and root access). To give the necessary permissions to all or selected remote systems, do the following steps.

6. Highlight a permission you want to grant other servers by pressing <Tab> until it is highlighted, then press <Enter>.

The utility displays a form for enabling the access rights to either ALL systems or to selected remote systems. If you want to give access to a list of remote systems, follow the steps listed below.

7. Highlight the “Selected Systems” field and press <Enter>.

8. Press <Tab> until the “Remote System Name” field is highlighted.

9. Enter the name of the remote system to which you want to give access and press <Enter>.

10. Highlight “ADD” and press <Enter>.

11. Repeat Steps 9 and 10 for all remote systems for which access permissions are to be given.

12. After adding all the remote systems that should have access to the filesystem move to the “OK” field and press <Enter>.

13. Repeat Steps 6 to 12 for all three permissions as necessary.

14. Move to the “OK” field and press <Enter>.

Note: The remote systems chosen must have an entry in the System-to-System connectivity list. To see this list, choose “System-to-System Connectivity” in the SAM main menu. Also, the NFS Server Service must be enabled from the main menu.

Mounting a File System on HP-UX Machine

Before an NFS user can access an exported NetWare® file system, you need to mount the NetWare file system onto the HP-UX* NFS machine. Use SAM to accomplish this task.

Adding a Directory to the Mount Form

Before you can mount a NetWare file system using SAM, you must supply the following information on the Add a File System for Mounting form:

Remote System Name—the name of the remote host that has the file system you want to mount.

Remote Directory Name—the name of the directory on the remote system that you want to mount.

Local Directory Name—the name of the empty directory in the HP-UX system you want to use as a mount point. If you use a directory that is not empty, the contents of that directory will be unavailable until you unmount the remote file system.

Note: Although this form contains other fields, only those in the preceding list are necessary to mount a file system. If you want further information about any of the other fields, highlight the field and press <F1>.

Mounting the File System

Use this procedure to mount a NetWare volume as a remote file system.

Note: For mounting NetWare volumes as remote file systems, the NFS Client Service should have been enabled on the HP-UX machine and the NetWare server should be in the System-to-System Connection List on the HP-UX machine.

1. Start SAM by entering

```
sam <Enter>
```

The utility displays the Main Menu.

2. From the Main Menu, make the following selections:

- ↳ **Networking/Communication Services**
- ↳ **Networked File Systems (NFS)**
- ↳ **Remote Directories Mounted**

The utility displays a list of remote file systems already mounted.

3. Move to the menu bar by pressing <F4>.

4. In the menu bar, make the following selections:

- ↳ **Actions**
- ↳ **Add**

5. Fill in the basic identifying information for mounting the remote file system.

This information includes the remote system name (the hostname of the NetWare NFS server), remote directory name and local directory name.

6. Fill in additional options (such as access permissions and mount options) as desired.

7. Move to the “OK” field and press <Enter>

The remote NetWare file system will be mounted.

Printing on HP-UX

The procedures in this section describe what you need to do at the UNIX* host before you can use NetWare® bidirectional printing services.

UNIX-to-NetWare Printing

Remote computers supporting the LPR protocol can print to NetWare printers using the UNIX-to-NetWare print service. This requires the following information:

Printer Name—the name of the printer on the local HP-UX system that users will print to.

Remote System Name—the host name of the NetWare server that will service print jobs.

Remote Printer Name—the name of the Novell print queue on the NetWare server that will service print jobs.

In addition to setting up this print service as described in “Managing Print Services” on page 172, you must configure your HP-UX host as follows:

1. **To add the NetWare server to the /etc/hosts file on your HP-UX host, do the following:**

- 1a. **Start the system administration utility from the shell by typing**

```
sam <Enter>
```

The utility displays the SAM main menu.

- 1b. **Make the following selections:**

- ↳ **Networking/Communications**
- ↳ **System-to-System Connectivity**
- ↳ **Internet Connectivity**

The utility will display a list of IP addresses and host names connected to the system.

2. Move to the menu bar by pressing <F4>.

3. From the menu bar, make the following selections

↳ **Actions**

↳ **Add**

The utility will display a form for adding a host to the system's connected list.

4. Enter the host name of the NetWare server and its IP address in the appropriate fields.

5. Move to the <OK> field and press <Enter> .

The NetWare server is added to the system connectivity list.

6. If SAM is not already running (in other words, if you did not need to perform Step 1), start SAM from the shell by typing

```
sam <Enter>
```

The utility displays the SAM main menu.

7. From the SAM main menu, make the following selections:

↳ **Printers and Plotters**

↳ **Printers/Plotters**

The utility shows a list of printers configured in the system and their status.

8. Move to the menu bar by pressing <F4>.

9. Make the following selections:

↳ **Actions**

↳ **Add Remote Printer/Plotter**

The utility will display a form for entering details about the remote printer.

10. Fill in the basic identifying information for the remote printer.

This information includes the Printer Name, Remote System Name, and the Remote Printer Name.

11. Enable the property “Remote Printer is on a BSD System.”
12. Fill in additional options as desired.
13. Move to the <OK> field and press <Enter>.

The remote printer is added to the list of printers.

14. You can verify the printer setup by giving a print job to the remote printer by typing

```
lp -d NetWare_printer_name filename <Enter>
```

Use the printer name the HP-UX users see for NetWare_printer_name and use any text file for filename.

NetWare-to-UNIX Printing

This section describes how to configure an HP-UX system to accept a print job from a NetWare client.

1. Start the SAM utility by typing

```
sam <Enter>
```

2. Make sure the host name and IP address of the NetWare server are in the /etc/hosts file on the HP-UX system. Do the following:

- 2a. Make the following selections from the SAM main menu:

- ↳ Networking/Communications
 - ↳ System-to-System Connectivity
 - ↳ Internet Connectivity

The utility will display a list of IP addresses and host names connected to the system.

- 2b. If the NetWare server is not listed, move to the menu bar by pressing <F4>.

2c. From the menu bar, make the following selections

↳ **Actions**

↳ **Add**

The utility will display a form for adding a host to the system's connected list.

- 3. Enter the host name of the NetWare server and its IP address in the appropriate fields.**

- 4. Move to the <OK> field and press <Enter>.**

The NetWare server is added to the system connectivity list.

- 5. From the SAM main menu, make the following selections:**

↳ **Printers and Plotters**

↳ **Printers/Plotters**

The utility will display a list of configured printers and their types (local or remote). You can choose one of the local printers for printing from NetWare clients.

- 6. Move to the menu bar by pressing <F4>.**

- 7. Make the following selections:**

↳ **Actions**

↳ **Add local Printer/Plotter**

↳ **Add <YourPrinterType> Printer**

Available types for <YourPrinterType> are Add Parallel Printer/Plotter, Add Serial Printer/Plotter, Add HP-IB Printer, Add Printer/Plotter Requiring Nonstandard Device File, and Add Printer/Plotter to a TSM(1) Terminal.

- 8. Fill in the form with the details of your specific printer.**

- 9. Move to the <OK> field and press <Enter>.**

- 10. Configure the NetWare print queue to work with the UNIX printer as described in "Managing Print Services" on page 172 of this guide.**

NeXT Administration Procedures

Use this section to configure your NeXT* system to function with NetWare®.

Complete the following procedures as necessary:

- ◆ “Determining if NIS is in Use on NeXT” on page 363
- ◆ “Obtaining User, Group, and Host Information from NIS on NeXT” on page 363
- ◆ “Determining if DNS is in Use on NeXT” on page 364
- ◆ “Logging in as Root on NeXT” on page 364
- ◆ “Accessing the NeXT Administration Tools” on page 365
- ◆ “Identifying Your NetWare Server for NeXT” on page 365
- ◆ “Finding Information About a User on NeXT” on page 366
- ◆ “Compiling a List of User Names with UIDs and Primary GIDs in NeXT” on page 368
- ◆ “Compiling Local User, Group, and Hosts Files from the NeXT Database” on page 368
- ◆ “Creating a User Account and Setting a Password on NeXT” on page 369
- ◆ “Finding Information About Groups on NeXT” on page 370
- ◆ “Compiling a List of Group Names and GIDs in NeXT” on page 371
- ◆ “Creating a NeXT Group” on page 372
- ◆ “Exporting a File System in NeXT” on page 373
- ◆ “Mounting a File System on HP-UX Machine” on page 356
- ◆ “Printing on NeXT” on page 375

Determining if NIS is in Use on NeXT

To determine if your NeXT* system is using NIS, use the shell tool to access the command line and enter the following command:

```
ypwhich <Enter>
```

If the command returns a domain name, the system is using NIS to store user and group information. If the command returns a message similar to the following:

```
ypwhich: host not running ypbind
```

the system is using a different database to store user and group information.

Obtaining User, Group, and Host Information from NIS on NeXT

If your system is using NIS and you want the NetWare® server to use (point to) the NIS database on the NeXT* host, enter the NIS domain name and server address in the appropriate fields of the Server Profile form. For more information on using a non-NetWare NIS server, see “Using a Non-NetWare Server as the NIS Master” on page 222.

If your system is using NIS and you want to transfer the user, group, and host information from the NeXT machine to the NetWare server, you must first create files from the NIS database. The following commands create these files:

```
ypcat hosts > /tmp/hosts <Enter>  
ypcat passwd > /tmp/passwd <Enter>  
ypcat group > /tmp/group <Enter>
```

You can now transfer the files to the NetWare server using the UNICON utility’s FTP function (see “Copying a File from a Remote Host” on page 240).

When the files are larger than 64 KB, you cannot use the edit file function available through the UNICON utility to edit unwanted entries. If any of your files are too large, use a DOS editor or remove the unwanted entries before you transfer the file from the NeXT system to the NetWare server.

Determining if DNS is in Use on NeXT

To determine if your NeXT* system is using DNS to store host information, search for the `resolv.conf` file located in the `/etc` directory. If this file exists, your system is using DNS. Otherwise, your system is using a different method to store host information.

If your system is using DNS and you want the NetWare® server to use (point to) the DNS host database on the NeXT host, enter the domain name and name server address contained in the `resolv.conf` file in the appropriate fields of the Server Profile form.

Logging in as Root on NeXT

Before performing a NeXT* administration task, log in to the NeXT host using the administration account. The following procedure assumes you have access to the NeXT host's system console and the root password.

- 1. Log in to the NeXT host as root by typing**

```
root <Enter>
```

The host prompts you for the root account's password.

- 2. Type the password for the root account and press <Enter>.**

The host logs you in to the system as root and displays the NeXT desktop.

Accessing the NeXT Administration Tools

Use the following procedure to access the NeXT* Administration icons.

1. **From the Workspace menu, make the following selections:**

- ↳ **Window**
- ↳ **File Viewer**

The utility displays the NeXTAdmin icon.

2. **Start the NeXTAdmin tool by double-clicking on the NeXTAdmin icon.**

The tool displays all of the Administration icons.

Identifying Your NetWare Server for NeXT

The NeXT* host needs to know about other computers with which it communicates. Use the Host Manager Application to inform the NeXT host of new computers.

1. **Start the Host Manager application by double-clicking on the Host Manager icon.**

The application displays its Main Menu in the upper left-hand corner of the screen.

2. **From the Main Menu, make the following selections:**

- ↳ **Host**
- ↳ **New**

The application displays a New Host Information form.

3. **Type the NetWare® server name into the Hostname field and press <Enter>.**

The cursor moves to the Internet Address Field.

4. **Fill in the NetWare server's IP address and press <Enter>.**

The application enters the IP address into the field.

5. **From the application's Main Menu, make the following selections:**

- ⇒ **Host**

- ⇒ **Save**

The application displays a list of domains.

6. **Highlight the appropriate domain and click on OK.**

The application saves the new host information.

7. **Click on the X located at the upper right-hand corner of the window to exit the window.**

The application's Main Menu remains in the upper left-hand corner of the screen.

Finding Information About a User on NeXT

For each NetWare® user accessing remote files through the NetWare server, you need to know both the user's user identification number (UID) and the group identification number (GID) of the user's primary login group.

This information is stored in a user database. You can either use the information in "Compiling Local User, Group, and Hosts Files from the NeXT Database" on page 368 to generate the local file and transfer the file to the NetWare server using the UNICON utility's FTP function (see "Copying a File from a Remote Host" on page 240) or manually obtain the information for each user as described in the following section.

Finding Information about a User with a NeXT Account Name

You use the User Manager application to display user information.

1. **Start the User Manager application by double-clicking on the User Manager icon.**

The application displays its Main Menu in the upper left-hand corner of the screen.

2. From the Main Menu, make the following selections:

- ↳ **User Record**
- ↳ **Open User...**

The application displays a list of domain names.

3. Highlight the appropriate domain in the top window and double-click on the user name in the bottom window.

The application displays the following information:

- ◆ User's full name
- ◆ User name
- ◆ Password
- ◆ User's default group
- ◆ UID
- ◆ User's home directory
- ◆ User's login shell
- ◆ Language
- ◆ Other groups to which the user belongs.

4. Click on the X located at the upper right-hand corner of the window to exit the window.

The application's Main Menu remains in the upper left-hand corner of the screen.

Compiling a List of User Names with UIDs and Primary GIDs in NeXT

If your NeXT* host has a large user database, you may want to create a file that lists every user and the user's corresponding UID and GID. Create this list using the `awk` command to filter the `nidump` data.

The following example creates a file that contains a three-column list of user names, UIDs, and GIDs. The list is stored in the host's `/tmp` directory.

```
nidump passwd . | awk '{FS=":";print $1,$3,$4}' /  
tmp/  
userinfo <Enter>
```

The file created by the example contains a list that looks like this:

```
root 0 1  
nobody 65534 65534  
daemon 1 1  
bin 3 3  
joeuser 1848 720
```

Compiling Local User, Group, and Hosts Files from the NeXT Database

Use the `nidump` command to generate local user, group, and hosts files to transfer to the NetWare® server.

The following commands create a `passwd`, `group`, and `hosts` file in the `/tmp` directory.

```
nidump passwd . | awk '{FS=":";print $1 " " $2 " " $3  
" "'}' > /tmp/passwd <Enter>  
nidump group . | awk '{FS=":";print $1 " " $2 " " $3  
" "'}' > /tmp/group <Enter>  
nidump hosts . | awk '{FS=":";print $1 " " $2 " " $3  
" "'}' > /tmp/hosts <Enter>
```

Creating a User Account and Setting a Password on NeXT

Use the User Manager application to create an account for a new user. Each user account must have a unique UID.

1. **Start the User Manager application by double-clicking on the User Manager icon.**

The application displays its Main Menu in the upper left-hand corner of the screen.

2. **From the Main Menu, make the following selections:**

- ↳ **User Record**

- ↳ **New User**

- ↳ **Local**

The application displays a form for adding a new user.

3. **Fill in the User's Full Name, Username, and Password fields.**

The form reflects the modifications as you enter each new value.

4. **Choose Switch to Long Form from the menu.**

The application displays additional fields.

5. **Select the new user's primary group from the list of groups and click on Set Default Group.**

You do not need to fill in any other information to create a user. If you are finished entering user information, proceed to Step 7. Otherwise, you can change the default settings for UID, Home Directory, Login Shell, Language, or Groups.

6. **Modify the remaining fields as appropriate.**

The form reflects the modifications as you enter each new value.

7. **From the Main Menu, make the following selections:**

- ↳ **User Record**

- ↳ **Save**

The application prompts you to enter the new user's password.

- 8. Type the password and press <Enter>.**

The application prompts you to reenter the new user's password.

- 9. Reenter the password.**

The application displays a confirmation box prompting you to confirm the creation of the new user account.

- 10. Select Yes to save the user information.**

The application saves the information and creates the new user.

- 11. Click on the X located at the upper right-hand corner of the window to exit the window.**

The application's Main Menu remains in the upper left-hand corner of the screen.

Finding Information About Groups on NeXT

Each group defined on the NeXT* host has a listing in a user database. This database contains the user's group name and group identification number (GID).

You can either use the information in "Compiling Local User, Group, and Hosts Files from the NeXT Database" on page 368 to generate a local group file and transfer the file to the NetWare server using the UNICON utility's FTP function (see "Copying a File to a Remote Host" on page 241) or manually obtain the information for each group as described in the following section.

Finding Information about a Group Name

Use the User Manager application to display group information.

- 1. Start the User Manager application by double-clicking on the User Manager icon.**

The application displays its Main Menu in the upper left-hand corner of the screen.

2. **From the Main Menu, make the following selections:**

- ↳ **User Record**
- ↳ **Open User Group ...**

The application displays a list of domain names.

3. **Highlight the appropriate domain in the top window and double-click on the group name in the bottom window.**

The application displays the following information:

- ◆ Group name
- ◆ GID
- ◆ Group description

4. **Click on the X located at the upper right-hand corner of the window to exit the window.**

The application's Main Menu remains in the upper left-hand corner of the screen.

Compiling a List of Group Names and GIDs in NeXT

Use the `awk` command to compile a list of group names and GIDs.

The following example creates a file containing a two-column list of group names and GIDs. The list is stored in the host's `/tmp` directory.

```
nidump group . | awk '{FS=":";print $1,$3}' /tmp/  
groupinfo <Enter>
```

The file created by this example contains a list that looks like this:

```
wheel 0  
daemon 1  
operator 2
```

Creating a NeXT Group

Information about NeXT* groups is stored in the user database. To create a group, use the User Manager application. Each group must have a unique GID.

1. **Start the User Manager application by double-clicking on the User Manager icon.**

The application displays its Main Menu in the upper left-hand corner of the screen.

2. **From the Main Menu, make the following selections:**

- ↳ **User Record**
 - ↳ **New User Group**

The application displays a form for adding a new user.

3. **Highlight the appropriate domain and click on OK.**

The application displays a form for adding a new user group.

4. **Fill in the Group Name field.**

You do not need to fill in any other information to create a group. However, if you do not want the next available GID, you can type a GID into the GID field. You can also use the Group Description field to enter a text description of the group.

5. **From the Main Menu, make the following selections:**

- ↳ **User Record**
 - ↳ **Save**

The application saves the information and creates the new group.

6. **Click on the X located at the upper right-hand corner of the window to exit the window.**

The application's Main Menu remains in the upper left-hand corner of the screen.

Exporting a File System in NeXT

Grant the NetWare® server authorization to access a specific file system by using the NFS Manager application.

1. **Start the NFS Manager application by double-clicking on the NFS Manager icon.**

The application displays its Main Menu in the upper left-hand corner of the screen.

2. **From the Main Menu, make the following selections:**

☞ **Export from...**

The application displays a form for exporting a directory.

3. **Highlight the directory to export and click on OK.**

The application returns to the Exported Directories screen. By default, all directories are exported with read/write access. You can use the Remove and Add buttons to change the access permissions.

4. **To modify the access rights, enter the applicable hostname in the text box below the corresponding access right and click on Add.**

The application saves the information and changes the access rights for the specified host.

5. **Click on the X located at the upper right-hand corner of the window to exit the window.**

The application's Main Menu remains in the upper left-hand corner of the screen.

Mounting a Remote File System from NeXT Machine

Use the NFS Manager application to set up access to a remote file system.

- 1. Start the NFS Manager application by double-clicking on the NFS Manager icon.**

The application displays its Main Menu in the upper left-hand corner of the screen.

- 2. From the Main Menu, make the following selections:**

☞ **Export from...**

The application displays a form for exporting a directory.

- 3. Highlight the directory to export and click on OK.**

The application returns to the Exported Directories screen. By default all directories are exported with read/write access. You can use the Remove and Add buttons to change the access permissions.

- 4. To modify the access rights, enter the applicable hostname in the text box below the corresponding access right and click on Add.**

The application saves the information and changes the access rights for the specified host.

- 5. Click on the X located at the upper right-hand corner of the window to exit the window.**

The application's Main Menu remains in the upper left-hand corner of the screen.

Printing on NeXT

The procedures in this section describe what to do at the UNIX* host to use NetWare® bidirectional printing.

Printcap File Format

Many operating systems (including NeXT*) use a printcap (printer capability) file to configure local and remote printing. The file has an entry for each printer in the following format (for information on additional options, enter “man printcap” at the UNIX prompt):

```
printer_name1 | printer_name2 | printer_nameN | \  
: printer_description : lp=print_device_name : \  
: rm=netware_server_name : \  
: rp=netware_print_queue_name : \  
: scd= /user/spool/spool_directory : mx#file_size  
: rs :
```

Where

printer_name1, *printer_name2*, ... *printer_nameN*—names used by UNIX users to refer to this printer.

printer_description—a text string that describes the printer in more detail (for example: “Laser printer on first floor”).

print_device_name—name of a print device on the local UNIX machine (for example, “lp=/dev/lp”). When printing to a printer on a remote machine, *print_device_name* should be the null character (for example, “lp=”).

netware_server_name—name of the NetWare server accepting print jobs. This should be the name listed in the /etc/hosts file on the UNIX host for the NetWare server.

netware_print_queue_name—name of the remote NetWare print queue. This entry is not case sensitive.

spool_directory—name of the spool directory on the local UNIX machine. This is where print jobs are temporarily stored before they are printed. You must manually create this directory (for example: as root, type at the UNIX prompt “mkdir /usr/spool/spool_directory”). It is customary to give *spool_directory* the same value as *netware_print_queue_name*.

#file_size—the maximum size (measured in blocks) of a file that can be spooled to the printer. If *file_size* = 0, files of unlimited size can be spooled to the printer.

rs—remote users can use this printer only if they have a local account on the system. Omitting the *rs* parameter enables any remote user on a “trusted host” to use this printer.

UNIX-to-NetWare Printing

Remote computers supporting LPR protocol can send files to NetWare printers using the UNIX-to-NetWare print service. In addition to setting up this print service (as described in “Managing Print Services” on page 172), you need to configure your host machine.

Configure the NeXT workstations connected to printers in one of two ways: standalone machines or part of a NetInfo domain network.

- ◆ To print from a standalone machine, configure the *printcap* file and *printcap* NetInfo database on each NeXT machine. This applies to each NeXT system with a printer to be made available to any NetWare client (DOS, MS* Windows*, OS/2*, or Macintosh*).
- ◆ For a NetInfo network, you only need to configure the master *printcap* NetInfo database for each pertinent domain.

Complete the applicable steps for standalone workstation or NetInfo domain setup:

1. Log in as root by typing

```
root <Enter>
```

The host prompts you for the root account’s password.

2. Type the password for the root account and press <Enter>.

The host logs you in to the system as root and displays the command prompt.

3. Add the NetWare server name and IP address to the hosts database on your NeXT machine. You can accomplish this in one of two ways:
 - 3a. From the Host Menu, select the New option.
 - 3b. Complete the form presented on screen. Do not click on the Host Runs NetInfo check box for the NetWare server entry.
 - 3c. From the Host Menu, select Save.
 - 3d. Or, add the server name and IP address to the `/etc/hosts` file.
 - 3e. Update the local NetInfo database by entering the following command:

```
niload hosts . < /etc/hosts
```

The NetInfo database for the master would be the entire domain.

4. Use a text editor to add the printer entry to the `/etc/printcap` file.
5. Create a spool directory by entering the following command at the UNIX prompt:

```
mkdir /usr/spool/queue
```

where *queue* is the exported queue you create on the NetWare server for access by remote users.

6. Update the NetInfo printcap database for either the local machine or (if this is a NetInfo master) the entire domain by entering the following command:

```
niload printcap . < /etc/printcap
```

7. **Type the names and IP addresses of the workstations from one of the following categories into the NetWare server's hosts file:**
 - ◆ Each standalone NeXT workstation you have configured.
 - ◆ Every NeXT workstation in the domain(s) of every master NetInfo server you have configured.
8. **Add the name of each NeXT workstation to the list of LPD trusted hosts on the NetWare server (refer to "Authorizing the NetWare Server to Access the UNIX Host" on page 181).**

You can now spool print jobs from all of your configured NeXT workstations or every NeXT workstation in configured domains to the NetWare server.

Try printing to the NetWare printer by entering the following command:

```
lpr -Pprinter_name filename
```

Examine the print queue on the NetWare server by entering the following command:

```
lpq -Pprinter_name
```

NetWare-to-UNIX Printing

Configure the NeXT workstations connected to printers in one of two ways: standalone machines or part of a NetInfo domain network.

Printing from Standalone Workstations

Configure the printcap file and printcap NetInfo database on each NeXT machine. This applies to each NeXT system with a printer to be accessed by any NetWare client (DOS, MS Windows, OS/2, or Macintosh).

1. **Log in as root by typing**

```
root <Enter>
```

The host prompts you for the root account's password.

2. **Type the password for the root account and press <Enter>.**

The host logs you in to the system as root and displays the command prompt.

3. **Run the NetManager utility.**

4. **Add the NetWare server name and IP address to the hosts database on your NeXT machine.**

- 4a. **From the Host Menu, select the New option.**

- 4b. **Complete the form presented on screen. Do not click on the Host Runs NetInfo check box for the NetWare server entry.**

- 4c. **From the Host Menu, select Save.**

5. **Run the PrintManager utility.**

The PrintManager displays a list of available printers including locally attached printers and printers attached to remote UNIX machines.

To see if a printer is local or remote, click on each printer and observe the notice on the form. For a local printer, the words “Note: This is a local printer” appear.

6. **If you wish to access a local printer configured as private, change the access to public.**

7. **Fill in the Remote Name field of the form.**

This is the printer name that you will use for configuring the Print Gateway software.

8. **Make sure the domain of the printer is at the root level (/) so any host can access it.**

9. **Click OK to save the print configuration.**

10. **Add the name and IP address of the standalone NeXT workstation to the NetWare server’s hosts database (“Hostgroup Information List” on page 127).**

11. Configure the print gateway using UNICON.

You need the UNIX name of the NeXT printer and the UNIX host name of the standalone workstation. It is possible, but not recommended, to use the name by which the NeXT workstation refers to its printer.

12. Add the name of the NetWare server to the /etc/hosts.lpd file on the standalone NeXT workstation.

13. Log in to the NetWare server and try printing to a UNIX printer with the following command:

```
nprint filename /q=name_of_queue
```

Printing in a NetInfo Domain Network

For a NetInfo network, configure the master printcap NetInfo database for each pertinent domain. Complete the following steps on the master server in each NetInfo domain.

There are two ways to configure the print gateway:

- ◆ You can configure the print gateway to send all print jobs to the master NetInfo server machine. The server then forwards the job to the correct printer within its domain.
- ◆ As an alternative, you can configure the print gateway to send print jobs directly to the NeXT workstation to which the printer specified to receive the print job is attached.

To Print in a NetInfo DomainNetwork, do the following:

1. Log in as root by typing

```
root <Enter>
```

The host prompts you for the root account's password.

2. Type the password for the root account and press <Enter>.

The host logs you in to the system as root and displays the command prompt.

3. **Add the NetWare server name and IP address to the /etc/hosts database on your NeXT machine.**
4. **Update the local NetInfo database by entering the following command:**

```
niload hosts . < /etc/hosts
```

The NetInfo database for the master is the entire domain.

5. **Run the PrintManager utility.**

The PrintManager displays a list of available printers including locally attached printers and printers attached to remote UNIX machines.

To see if a printer is local or remote, click on each printer in turn and observe the notice on the form. For a local printer, the words “Note: This is a local printer” appear.

6. **Set up the print gateway software. To send print jobs to the NetInfo server, complete the following steps. If you prefer to send jobs directly to the workstation to which the printer is attached, skip to Step 7.**

- 6a. **Run the PrintManager utility on the NeXT machine that is the NetInfo master server for the domain.**

The utility displays a list of available printers.

- 6b. **Make a note of the names of all applicable printers to which you want to send print jobs.**

These printers may be attached to the master NetInfo server machine or located on NeXT workstations within its domain. The PrintManager displays the long names of each printer by default.

- 6c. **If the names displayed are very long or contain spaces, type the following command to see the raw printcap entries for each configured printer.**

```
nidump printcap .
```

- 6d. Ensure that each printer not physically attached to the master NetInfo server has a printcap entry specifying the remote machine and printer name, as in the following example:

```
rm=<remote_machine>:rp=<remote_printer>
```

- 6e. Using UNICON, add each printer to the NetWare list of configured printers (“Configuring the UNIX Printer” on page 182).

Use the name of the NetInfo master server as the UNIX hostname.

- 6f. Add the name of the NetWare server to the `/etc/hosts.lpd` file on the master NetInfo server.

7. To send print jobs directly to the workstation, complete the following steps.

- 7a. Run the PrintManager utility on the machine that is the NetInfo master for the domain.

- 7b. Write down the names of the printers that you wish to access from NetWare and the names of the NeXT workstations to which they are attached.

- 7c. Add the names and IP addresses of all the workstations that have printers you wish to access to the NetWare server’s hosts database (“Hostgroup Information List” on page 127).

You can find out the IP addresses of workstations by typing the following command (the trailing period is important):

```
nidump hosts .
```

- 7d. Using UNICON, add each host-printer combination to the NetWare list of configured printers (“Configuring the UNIX Printer” on page 182).

- 7e. Add the name of the NetWare server to the `/etc/hosts.lpd` file on every NeXT workstation that has a printer to be made available to NetWare.

8. **Log in to the NetWare server and try printing to a UNIX printer with the following command:**

```
nprint filename /q=name_of_queue
```

SCO Administration Procedures

Use this section to configure your SCO* system to function with NetWare®.

Complete the following procedures as necessary:

- ◆ “Determining if NIS is in Use on SCO” on page 384
- ◆ “Obtaining User, Group, and Host Information From NIS on SCO” on page 384
- ◆ “Determining if DNS is in Use on SCO” on page 385
- ◆ “Logging In as Root on SCO” on page 385
- ◆ “Identifying Your NetWare Server for SCO” on page 385
- ◆ “Finding Information About a User on SCO” on page 386
- ◆ “Creating a User Account and Setting a Password on SCO” on page 388
- ◆ “Finding Information About Groups on SCO” on page 391
- ◆ “Creating a SCO Group” on page 392
- ◆ “Exporting a File System in SCO” on page 394
- ◆ “Printing on SCO” on page 396

Determining if NIS is in Use on SCO

To determine if your SCO* UNIX* system is using NIS, enter the following command:

```
ypwhich <Enter>
```

If the command returns a domain name, the system is using NIS to store user and group information. The system is using local files to store user and group information if the command returns a message similar to the following:

```
ypwhich: host not running ypbind
```

Obtaining User, Group, and Host Information From NIS on SCO

If your system is using NIS and you want the NetWare® server to use (point to) the NIS database on the UNIX* host, enter the NIS domain name and server address in the appropriate Server Profile fields. For more information on using a non-NetWare NIS server, see “Using a Non-NetWare Server as the NIS Master” on page 222.

If your system is using NIS and you want to transfer user, group, and host information from your UNIX host to the NetWare server, you must first create files from the NIS database. The following commands create these files:

```
ypcat hosts > hosts <Enter>
ypcat passwd > passwd <Enter>
ypcat group > group <Enter>
```

You can now transfer files to the NetWare server using the UNICON utility's FTP function (see “Copying a File from a Remote Host” on page 240).

When the files are larger than 64 KB, you cannot use the edit file function available through the UNICON utility to remove unwanted entries. If any of your files are too large, either use a DOS editor or remove the unwanted entries before you transfer the file from the SCO* UNIX system to the NetWare server.

Determining if DNS is in Use on SCO

To determine if your SCO* UNIX* system is using DNS to store host information, search for the `resolv.conf` file located in the `/etc` directory. If this file exists, your system is using DNS. Otherwise, your system is using a local hosts file to store host information.

If your system is using DNS and you want the NetWare® server to use (point to) the DNS host database on the UNIX host, enter the domain name and server address contained in the `resolv.conf` file in the appropriate Server Profile fields.

Logging In as Root on SCO

Before you perform an SCO* UNIX* administration task, log in to the SCO UNIX host using the administration account. The following procedure assumes that you have access to the SCO UNIX host's system console and the root password.

- 1. Log in to the UNIX host as root by typing**

```
root <Enter>
```

The host prompts you for the root account's password.

- 2. Type the password for the root account and press <Enter>.**

The host logs you in to the system as root and displays the command prompt.

Identifying Your NetWare Server for SCO

The UNIX* host needs to know about other computers with which it communicates. Inform the UNIX host of new computers by editing a file named `hosts`. This file is stored in the `/etc` directory.

The `hosts` file contains two information fields:

- ◆ The IP address field, which contains a host's IP address formatted as a series of four integers separated by periods.
- ◆ The host name field, which contains a host's official name.

The following example shows several entries from a hosts file:

```
192.53.4.1 tulip
192.53.3.6 chaos
192.53.5.12 newyork ny nyc
```

1. **Use an editor to open the UNIX hosts file.**
2. **Create a new entry for the NetWare® server by typing the IP address, a space, and the server's hostname**
3. **Save the edited hosts file and exit the editor.**

Finding Information About a User on SCO

For each NetWare® user accessing files through the Gateway, you need the user's user identification number (UID) and the group identification number (GID) of the user's primary login group.

This information is stored in the passwd file and is stored in the /etc directory. You can transfer the passwd file to the NetWare server using the UNICON utility's FTP function (see "Copying a File from a Remote Host" on page 240) or manually obtain the information for each user as described in the following section.

Finding User Information with a UNIX Account Name

Use the grep command to display information about a user:

```
grep username /etc/passwd <Enter>
```

Replace *username* with the user's UNIX* account name. The following example illustrates how to find information about a user named joeuser:

```
grep joeuser /etc/passwd <Enter>
```

```
joeuser:qzogGcQdTB5zk:1848:720:Joseph User:/home/  
joeuser:/bin/csh
```

User information is displayed in seven fields. Each field is separated by a colon (:). The fields contain the following information:

- ◆ The first field contains the user's account name.
- ◆ The second field contains the user's password in an encrypted format.
- ◆ The third field contains the user's UID.
- ◆ The fourth field contains the user's primary GID.
- ◆ The fifth field contains the user's full name.
- ◆ The sixth field contains the user's home directory.
- ◆ The seventh field contains the path and name of the UNIX shell that the system runs when the user logs in to the host.

Finding User Information with a User's Full Name

If you do not know a user's account name, you can use the `grep` command and the user's full name to find information. The following command illustrates how to find the entry for the `joeuser` account using the name `Joe User`:

```
grep 'Joe User' /etc/passwd <Enter>
```

This command displays the same information as the previous example.

Compiling a List of User Names with UIDs and Primary GIDs

If your UNIX host has a large `passwd` file, you may want to create a file that lists every user and the user's corresponding UID and GID. Create this list using the `awk` command.

The following example creates a file that contains a three-column list of user names, UIDs, and GIDs. The list is stored in the host's /tmp directory.

```
awk '{FS=":";print $1,$3,$4}' /etc/passwd /tmp/  
userinfo <Enter>
```

The file created by the example contains a list that looks like this:

```
root 0 1  
nobody 65534 65534  
daemon 1 1  
bin 3 3  
joeuser 1848 720
```

Creating a User Account and Setting a Password on SCO

Each user account must have a unique UID. If an account already exists on another UNIX* machine, create the new account using the same UID and GID as on the existing system. To display a list of the current users and their UID numbers, refer to “Compiling a List of User Names with UIDs and Primary GIDs” on page 387.

Creating a User Account

Use the following procedure to create a user account.

Note: The form you use to create a user account contains many fields, but only those listed in the following procedure are necessary to create a new user. If you want further information about any of the other fields, highlight the field and press <F1>.

1. **Start the sysadmsh utility by entering the following command:**

```
sysadmsh <Enter>
```

2. From the Main Menu, make the following selections:

- ⇒ **Account**
- ⇒ **User**
- ⇒ **Create**

The utility displays a form for adding new user information.

3. Fill in the user's login name and press <Enter>.

The utility highlights the Comment field.

4. Fill in the user's full name and press <Enter>.

The utility highlights the Modify Defaults? field.

5. Select Yes to modify the values.

The utility displays the New user account parameters form.

6. Type the Primary GID in the Login Group field.

You do not need to fill in any other information to create a user. However, you can change the default settings for UID, Home Directory, Login Shell, Language, and Group.

7. Modify the parameters as appropriate and press <Enter> until you reach the end of the screen.

The utility displays a confirmation box for you to confirm the creation of the new user.

8. Select Yes to create the user or No to cancel the operation.

The utility exits the form and creates the new user.

After you create a new user, you must add the user to the appropriate group(s). For instructions on how to add a user to a group, refer to "Adding a Member to a Group" on page 393.

Setting a User's Password

Use the following procedure to set a user's password.

1. **Start the sysadmsh utility by typing**

```
sysadmsh <Enter>
```

2. **From the Main Menu, make the following selections:**

```
↳ Accounts
  ↳ User
    ↳ Examine
```

The utility displays a form for entering the new user's name.

3. **Fill in the user name or use <F3> to highlight a user name and press <Enter>.**

The utility displays the user account that you selected.

4. **Press <Enter> to enter a new password.**

The utility prompts you for the new password.

5. **Type the new password and press <Enter>.**

The system prompts you to reenter the password.

6. **Reenter the password.**

The system assigns the password when you exit the screen.

Modifying Existing User Information

Use the following procedure to modify existing user information.

1. **Start the sysadmsh utility by typing**

```
sysadmsh <Enter>
```

2. From the Main Menu, make the following selections:

- ↳ **Accounts**
- ↳ **User**
- ↳ **Examine**

The utility provides a field in which to enter a specific user account.

3. Enter a user account in the field, or press <F3> to display a list of user accounts, highlight an account, and press <Enter>.

The utility displays information about the account in the user account form.

4. To display or modify information, select a specific menu option, modify the parameters as necessary, and press <Enter> until you reach the end of the screen.

The utility displays a confirmation box asking you to confirm the modifications.

5. Select Yes to confirm the modifications or No to cancel the operation.

When you select Yes, the utility saves the information and exits the form.

Finding Information About Groups on SCO

For each NetWare® user accessing remote files through the NetWare server, you need the user's user identification number (UID) and the group identification number (GID) of the user's primary login group.

Each group defined on the UNIX* host is listed in a file named group and is stored in the /etc directory. You can transfer the group file to the NetWare server using the UNICON utility's FTP function (see "Copying a File from a Remote Host" on page 240) or manually obtain the information for each group as described in the following paragraphs.

You can compile a list of group names and group identification numbers using the awk command.

The following example creates a file that contains a two-column list of group names and GIDs. The list is stored in the host's /tmp directory.

```
awk '{FS=":";print $1,$3}' /etc/group /tmp/  
groupinfo <Enter>
```

The file created by this example contains a list that looks like this:

```
wheel 0  
daemon 1  
operator 2
```

Creating a SCO Group

Information about groups is stored in the /etc/group file. To create a group, add an entry for the group to this file.

Setting Up the /etc/group File

To create a new group, use a text editor to open the group file and insert information about the group.

The group file consists of the following four fields:

- ◆ Group name
- ◆ Group password
- ◆ GID
- ◆ List of users who are members of the group

Each field is separated from the next by a colon (:). Group members names are separated by commas (,).

Following is a sample entry from the group file:

```
wheel*:0:daemon,root
```

Each group must have a unique GID. The asterisk in the password field means that members cannot use the `newgrp` command to temporarily switch their primary group association to the group.

1. **Use an editor to open the group file.**
2. **Create an entry for the new group as shown in the previous example.**
3. **Save the edited group file and exit the editor.**

Adding a Member to a Group

Add a user to a group by using a text editor to open the `etc/group` file and insert information about the new member.

The fourth field in the group file contains names of the group members. Individual names are separated by commas (,).

The following is an example entry from the group file. The group members are `arnolds` and `rdoover`.

```
newgroup:*:902:arnolds,rdoover
```

1. **Use an editor to open the group file.**
2. **Add the new member at the end of the entry for the appropriate group.**
3. **Save the edited group file and exit the editor.**

Exporting a File System in SCO

Grant the NetWare® server authorization to access a specific file system by adding the appropriate entry in the NetWare server's `/etc/exports` file.

Note: The UNIX system must be running the `portmap`, `nfsd`, and `mountd` daemons to successfully export a file system.

Setting Up the `/etc/exports` File

Before a NetWare client can access a file system on a NFS server, the file system's mount path and those clients allowed access to the files must be entered in the `/etc/exports` file, which resides on the NetWare server. This entry has the following syntax:

```
filesystem [ option1 [ option2 ] ... ]
```

For *filesystem*, specify the path using UNIX* conventions (pathnames are case sensitive). Here is an example of a path in UNIX:

```
/nfs1/users
```

The options can be any combination of the following. Use a comma to separate options.

```
-access=client1[:client2 [:client3]]...
```

This option identifies which clients are allowed to access the file system. If this option is not specified, any client can access the file system. Replace *client* with the NetWare server's hostname. If more than one client is listed, separate each name with a colon.

```
-anon
```

This option specifies if anonymous (not known to the system) users can access the file system. If `anon` is not specified, the default is Yes. If `anon` is specified, the default is No. (NFS assigns anonymous user an identification of UID -2 and GID-2)

```
-ro
```

This option specifies that the directory be exported in read-only format. If this option is not specified, the directory is exported as read-write.

```
-root=hostname1[:hostname2 [:hostname3]. . . ]
```

This option specifies which root users can access the file system. If this option is not specified, root UID 0 receives the rights of the NetWare class NOBODY, granting the privileges of the UNIX user class “others” to root.

Replace *hostname* with the name of the NetWare client. If more than one client is listed, separate each name with a colon.

```
-rw:hostname
```

This option specifies that the directory be exported to the specified host for reading and writing. This option overrides the **-ro** option. If no *hostname* is given, the directory is exported read-write to all.

Examples

Here are two examples of an entry in the exports file:

```
# "Exported Path", "Trusted Systems"  
/nfs1/project2 -access=sunrise:ca:na,  
-root=sunrise, -ro, -rw:sunrise, -anon
```

In the preceding example, the NetWare server’s directory file system to be accessed is /nfs1/project2. The clients that can access the file system are “sunrise,” “ca,” and “na.” The superuser on sunrise also has root privileges in the /nfs1/project2 file system. The clients “ca” and “na” have “read only” access to the file system, but “sunrise” has “read and write” permission. Anonymous users (classified as NOBODY or NOGROUP) are not allowed to access the file system.

```
/nfs1/project3 -ro
```

In the preceding example, all clients can access the file system /nfs1/project3 with “read only” permission, and all NetWare users with a UID of 0 are granted privileges equivalent to the NetWare user NOBODY.

Mounting a Remote File System

You mount an exported NetWare directory by adding the appropriate entry using the `sysadmsh` utility.

1. **Start from the `sysadmsh` Main Menu and make the following selections:**

↳ **Filesystems**

↳ **Mount**

The utility prompts for the Device to Mount.

2. **Enter the device and path of the remote directory.**

The utility prompts for the Directory to Mount the Specified Filesystem.

3. **Enter the directory that you want to use as a mount path.**

Printing on SCO

The procedures in this section describe what to do at the UNIX* host to use NetWare® bidirectional printing.

Notice About TCP/IP Versions Older than 1.2

SCO's TCP/IP versions prior to 1.2 do not have LPD printing support. Therefore, you must use an alternative method for spooling print jobs to NetWare queues. Here are two potential solutions.

Neither of these alternative methods is recommended. You should upgrade to SCO's TCP/IP v1.2 implementation or later, which supports the LPD protocol. If you have TCP/IP v1.2 or later, you can use the procedure in the next section to spool jobs to NetWare print queues.

- ◆ Make "rsh" calls from the SCO machine to a UNIX machine that supports LPD.
- ◆ Run scripts on the SCO machine that enable you to spool jobs to NetWare print queues.

Printcap File Format

Many operating systems (including SCO) use a printcap (printer capability) file to configure local and remote printing. The file has an entry for each printer in the following format (for information on

```
printer_name1 | printer_name2 | printer_nameN | \  
: printer_description : lp=print_device_name : \  
: rm=netware_server_name : \  
: rp=netware_print_queue_name : \  
: sd= /user/spool/spool_directory : mx#file_size  
: rs :
```

Where

printer_name1, *printer_name2*, ... *printer_nameN*— names used by UNIX users to refer to this printer.

printer_description—a text string that describes the printer in more detail (for example: “Laser printer on first floor”).

print_device_name—name of a print device on the local UNIX machine (for example, “lp=/dev/lp”). When printing to a printer on a remote machine, *print_device_name* should be the null character (for example, “lp=”).

netware_server_name—name of the NetWare server accepting print jobs. This should be the name listed in the /etc/hosts file on the UNIX host for the NetWare server.

netware_print_queue_name—name of the remote NetWare print queue. This entry is not case sensitive.

spool_directory—name of the spool directory on the local UNIX machine. This is where print jobs are temporarily stored before they are printed. You must manually create this directory (for example: as root, type at the UNIX prompt “mkdir /usr/spool/*spool_directory*”). It is customary to give *spool_directory* the same value as *netware_print_queue_name*.

#file_size—the maximum size (measured in blocks) of a file that can be spooled to the printer. If *file_size* = 0, files of unlimited size can be spooled to the printer.

rs—remote users can use this printer only if they have a local account on the system. Omitting the *rs* parameter enables any remote user on a “trusted host” to use this printer.

Prerequisites

Before you proceed, see that the following prerequisites are met:

- SCO* TCP/IP v1.2 or later is running on your UNIX* host.
- The name and IP address of the NetWare® server are listed in the `/etc/hosts` file on your UNIX host.
- Remote line printing is configured. If you need help doing this, proceed as follows: As superuser `root`, type the command `mkdev rlp` at the UNIX prompt and follow the online instructions. (Refer to SCO documentation for more information on the `mkdev rlp` command.)

UNIX-to-NetWare Printing

There are two ways to configure UNIX-to-NetWare printing. One is to edit the `/etc/printcap` file. The other method is to run the `RLPCONFIG` utility, which prompts for input and updates the appropriate entries in the `/etc/printcap` file.

Editing the `/etc/printcap` File

Use this procedure to configure the `/etc/printcap` file with a text editor. (For an explanation of the format of the `/etc/printcap` file see, “Printcap File Format” on page 397.)

- 1. Log in to your SCO host as root.**
- 2. Using a text editor, add the printer entry to the `/etc/printcap` file.**
- 3. Create a spool directory by entering the following command at the UNIX prompt:**

```
mkdir /usr/spool/queue
```

where *queue* is the exported queue you create on the NetWare server for access by remote users.

4. **Try printing to the NetWare printer by typing the following command:**

```
lp -dprinter filename
```

5. **Examine the NetWare print queue on the NetWare server by typing the following command:**

```
lpstat printer
```

Using RLPCONFIG

Use this procedure to configure the printcap file using the RLPCONFIG utility.

1. **Log in to your UNIX host as root.**
2. **Start the RLPCONFIG utility by typing the following command at the UNIX prompt:**

```
r1pconf <Enter>
```

The utility prompts you for the remote printing configuration.

3. **Enter the applicable information for remote printers or local printers accepting remote printing requests.**

The utility prompts you to enter the printer name.

4. **Enter the name of the NetWare queue receiving the remote print jobs.**

The utility asks if the name you entered is a remote printer or a local printer.

5. **Enter r for remote.**

The utility prompts you to enter the name of the remote host to which the queue is attached.

6. **Enter the name of the NetWare server containing the queue.**

The utility prompts for confirmation that the printer you named is attached to the queue you named.

7. Enter y for yes.

The utility asks if you would like this to be the system default printer?

8. Enter n for no.

The utility displays information similar to the following:

```
Make sure your host name appears in sjf-mktg's /  
etc/host.equiv or /etc/host.lpd file
```

```
Make sure that unix2nw appears in sjf-mktg's /  
etc/
```

```
printcap file (BSD format)
```

```
Make sure that unix2nw has a spool directory on  
sjf-mktg
```

```
Putting unix2nw n printer description file and  
creating spool dir...done
```

```
Updating LP information...done
```

9. Try printing to the NetWare printer by typing the following command:

```
lp -dprinter_name filename
```

10. Examine the queue on the NetWare server by typing the following command:

```
lpstat queue_name
```

NetWare-to-UNIX Printing

There are two ways to configure NetWare-to-UNIX printing. One is to edit the `/etc/printcap` file. The other method is to run the `RLPCONFIG` utility, which prompts for input and updates the appropriate entries in the `/etc/printcap` file.

Editing the /etc/printcap File

Use this procedure to configure the /etc/printcap file with a text editor. (For an explanation of the format of the /etc/printcap file see, "Printcap File Format" on page 397.)

1. **Log in to your SCO host as root.**
2. **Using a text editor, add the printer entry to the /etc/printcap file.**
3. **Create a spool directory by entering the following command at the UNIX prompt:**

```
mkdir /usr/spool/queue
```

where *queue* is the exported queue you create on the NetWare server for access by remote users.

4. **Using a text editor, add the name of the NetWare server to the /etc/hosts.lpd file.**

This entry allows the NetWare server to spool print jobs to your SCO host.

5. **Log in to the NetWare server and try printing to the UNIX printer with the following command:**

```
NPRINT filename /q=queue
```

Using RLPCONFIG

Use this procedure to configure the /etc/printcap file using the RLPCONFIG utility.

1. **Log in to your SCO host as root.**
2. **Start the RLPCONFIG utility by typing the following command at the UNIX prompt:**

```
rlpconf <Enter>
```

The utility prompts you for the remote printing configuration.

3. **Enter the applicable information for remote printers or local printers accepting remote printing requests.**

The utility prompts you to enter the printer name.

4. **Enter in the name of the printer attached to your UNIX host.**

The utility prompts you to identify the name you entered as a remote printer or a local printer.

5. **Enter l for local.**

The utility prompts you to enter the name of the device for your printer.

6. **Enter lp, which is the print utility for your system.**

The utility prompts for confirmation that lp is the device used by your printer.

7. **Enter y for yes.**

The utility displays information similar to the following:

```
Putting printer in printer description file and  
creating spool dir...done
```

8. **Using a text editor, add the name of the NetWare server to the /etc/hosts.lpd file.**

This entry allows the NetWare server to spool print jobs to your SCO host.

9. **Log in to the NetWare server and try printing to the UNIX printer with the following command:**

```
NPRINT filename /q=queue
```

Solaris Administration Procedures

Use this section to configure your Solaris* system to function with NetWare®.

Complete the following procedures as necessary:

- ◆ “Determining if NIS Is in Use on Solaris” on page 404
- ◆ “Obtaining User, Group, and Host Information from NIS on Solaris” on page 404
- ◆ “Determining if DNS is in Use on Solaris” on page 405
- ◆ “Logging In as Root on Solaris” on page 405
- ◆ “Identifying Your NetWare Server for Solaris” on page 406
- ◆ “Finding Information About a User on Solaris” on page 407
- ◆ “Creating a User Account and Setting a Password on Solaris” on page 410
- ◆ “Finding Information About Groups on Solaris” on page 412
- ◆ “Creating a Solaris Group” on page 412
- ◆ “Exporting a File System on Solaris” on page 415
- ◆ “Mounting a File System from a Solaris Machine” on page 416
- ◆ “Printing on Solaris” on page 418

Determining if NIS Is in Use on Solaris

To determine if your system is using NIS, enter the following command:

```
ypwhich <Enter>
```

If the command returns a domain name, the system is using NIS to store user and group information. The system is storing user and group information in local files if the command returns a message similar to the following:

```
ypwhich: host not running ypbind
```

or

```
ypwhich: the domainname hasn't been set on this  
machine
```

Obtaining User, Group, and Host Information from NIS on Solaris

If your system is using NIS and you want your NetWare® server to use (point to) the NIS database on the UNIX* host, enter the NIS domain name and server address in the appropriate Server Profile fields. For more information on using a non-NetWare NIS server, see “Using a Non-NetWare Server as the NIS Master” on page 222.

If your system is using NIS and you want to transfer user, group, and host information from your UNIX host to the NetWare server, you must first create files from the NIS database. The following commands create these files:

```
ypcat hosts > hosts <Enter>  
ypcat passwd > passwd <Enter>  
ypcat group > group <Enter>
```

You can now transfer files to the NetWare server using the UNICON utility's FTP function (see “Copying a File from a Remote Host” on page 240).

When the files are larger than 64 KB, you cannot use the edit file function available through the UNICON utility to remove unwanted entries. If any of your files are too large, use a DOS editor or remove the unwanted entries before you transfer the file from the UNIX system to the NetWare server.

Determining if DNS is in Use on Solaris

To determine if your UNIX* system is using DNS to store host information, search for the `resolv.conf` file located in the `/etc` directory. If this file exists, your system is using DNS. Otherwise, your system uses a local hosts file to store host information.

If your system is using DNS and you want your NetWare® server to use (point to) the DNS host database on the UNIX host, enter the domain name and server address contained in the `resolv.conf` file in the appropriate fields of the Server Profile form.

Logging In as Root on Solaris

Before performing any UNIX administration task, log in to the UNIX host using the administration account. The following procedure assumes you have access to the UNIX host's system console. You also need to obtain the UNIX host's root password before you can log in to the host.

- 1. Log in to the UNIX host as “root” by typing**

```
root <Enter>
```

The host prompts you for the root account's password.

- 2. Type the password for the root account and press <Enter>.**

The host logs you in to the system as root and displays the desktop.

Identifying Your NetWare Server for Solaris

The UNIX* host needs to know about other computers with which it communicates. You inform the Solaris* host of new computers by using the administration tool, admintool.

The host information consists of the following:

- ◆ The IP address consists of a host's IP address formatted as a series of four integers separated by periods.
- ◆ The host name consists of a host's official name.

To identify your NetWare® Server, do the following:

1. **Start the system administration utility from the shell tool by typing**

```
admintool <Enter>
```

The utility displays the administration application icons.

2. **Start the Database Manager application by double-clicking on the Database Manager icon.**

The application displays the Main Menu.

3. **From the Main Menu, make the following selections:**

```
↳ Hosts
  ↳ Edit
    ↳ Add Entry
```

The utility displays a form in which you can enter the host information.

4. **Fill in the Host Name and IP Address fields and click on Add.**

The application saves the information and creates the host entry.

5. **Click in the upper left-hand corner of the window to exit.**

The application returns to the desktop.

Finding Information About a User on Solaris

For each NetWare® user accessing NFS files through the NetWare server, you need to know the user's user identification number (UID) and the group identification number (GID) of the user's primary UNIX* group.

This information is stored in the passwd file. This file is stored in the /etc directory. You can transfer the passwd file to the NetWare server using the UNICON utility's FTP function (see "Copying a File from a Remote Host" on page 240), or manually obtain the information for each user as described in the following sections.

Displaying a List of Users and UIDs

You use the following procedure to display a list of the current users and their UID numbers.

1. **Start the system administration utility from the shell tool by typing**

```
admintool <Enter>
```

The utility displays the administration application icons.

2. **Start the Database Manager application by double-clicking on the Database Manager icon.**

The application displays the Main Menu.

3. **From the Main Menu, make the following selection:**

☞ **Passwd**

The utility displays a list of all the users and their assigned UIDs.

Finding User Information with a UNIX Account Name

Use the `grep` command to display information about a user:

```
grep username /etc/passwd <Enter>
```

Replace *username* with the user's UNIX account name. The following illustrates how to find information about a user named *joeuser*:

```
grep joeuser /etc/passwd <Enter>
```

```
joeuser:qzogGcQdTB5zk:1848:720:Joseph User:/home/  
joeuser:/bin/csh
```

User information is displayed in seven fields. Each field is separated by a colon (:). The fields contain the following information:

- ◆ The first field contains the user's account name.
- ◆ The second field contains the user's password in an encrypted format.
- ◆ The third field contains the user's UID.
- ◆ The fourth field contains the user's primary GID.
- ◆ The fifth field contains the user's full name.
- ◆ The sixth field contains the user's home directory.
- ◆ The seventh field contains the path and name of the UNIX shell the system runs when the user logs in to the host.

Finding User Information with a User's Full Name

If you do not know a user's account name, you can use the `grep` command and the user's full name to find information. The following command illustrates how to find the entry for the `joeuser` account using the name `Joe User`:

```
grep 'Joe User' /etc/passwd <Enter>
```

This command displays the same information as the previous example.

Compiling a List of User Names with UIDs and Primary GIDs

If your UNIX host has a large `passwd` file, you may want to create a file listing every user and the user's corresponding UID and GID. Create this list using the `awk` command.

The following example creates a file containing a three-column list of user names, UIDs, and GIDs. The list is stored in the host's `/tmp` directory.

```
awk '{FS=":";print $1,$3,$4}' /etc/passwd /tmp/  
userinfo <Enter>
```

The file created by the example contains a list that looks like this:

```
root 0 1  
nobody 65534 65534  
daemon 1 1  
bin 3 3  
joeuser 1848 720
```

Creating a User Account and Setting a Password on Solaris

Use `admintool` to create an account for a new user.

Each user account must have a unique UID. If an account already exists on another UNIX machine, you must create the new account using the same UID and GID as on the existing system. To display a list of users along with their UID and GID, refer to the previous section, “Compiling a List of User Names with UIDs and Primary GIDs” on page 328.”

When you create a user, you need to supply the following information in the designated fields:

- ◆ User Name—the user name for the account.
- ◆ User ID—the UID of the user.
- ◆ Comment—user’s full name.
- ◆ Home Path Directory—full path to the user’s home directory.
- ◆ Shell—full path and name of the shell that executes when the user logs in to the host.

Note: Although the form you use to add a user account contains other fields, only those listed in the preceding are necessary to create a new user. All other fields are optional.

Creating a User Account

You use the following procedure to create a UNIX user account.

1. **Start `admintool` by entering the following command:**

```
admintool <Enter>
```

The utility displays the Administration application icons.

2. **Open the Database Manager application by double-clicking on the Database Manager icon.**

The application displays the Main Menu.

3. From the Main Menu, make the following selections:

- ↳ **Passwd**
- ↳ **Edit**
- ↳ **Add Entry**

The utility displays a form in which you can enter the new user information.

4. Fill in the User Name, User ID, Comment, Home Path directory, shell, and Group ID fields and click on Add.

The application saves the information and creates the user entry.

5. Click in the upper left-hand corner of the window to exit.

The utility returns to the desktop.

After you create a user, you need to add the user to the appropriate group(s). For instructions on adding a user to a group, see “Adding a Member to a Group” on page 414.

Setting a Password for the New Account

When you use the administration tool to add a user, the tool adds the user’s account entry to the `/etc/passwd` file and creates the home directory, including some necessary files.

The user entry in the `/etc/passwd` directory does not include a password. After you add the user account, run the `passwd` command and set a default password for the new account. The format for setting a password for Joe User’s account is shown in the following:

```
passwd joeuser
```

The system prompts you to enter the new password and reenter it to verify you typed it correctly. The `/etc/passwd` file is updated to include the encrypted version of the password.

Finding Information About Groups on Solaris

Each group defined on the UNIX* host has a listing in a file named `group`. This file is stored in the `/etc` directory. You can transfer the group file to the NetWare® server using the UNICON utility's FTP function (see "Copying a File from a Remote Host" on page 240) or obtain the information for each group manually as described in the following paragraphs.

1. **Start the system administration utility by typing**

```
admintool <Enter>
```

The utility displays the administration application icons.

2. **Start the Database Manager application by double-clicking on the Database Manager icon.**

The application displays the Main Menu.

3. **From the Main Menu, make the following selection:**

⇒ **Group**

The utility displays a list of all the groups and their assigned GIDs.

Creating a Solaris Group

The information about UNIX groups is stored in the `/etc/group` file. To create a new group, use `admintool`.

The new group must have a unique GID. If a group already exists on another UNIX machine, you must create the group using the same GID as on the existing system. To view a list of the current groups and their GID numbers, refer to "Finding Information About Groups on Solaris" on page 412.

When you create a group, you need to supply the following information:

- ◆ Group name
- ◆ GID
- ◆ A list of users who are members of the group

Creating a Group

You use the following procedure to create a group.

1. Start admintool by entering

```
admintool <Enter>
```

The utility displays the Administration application icons.

2. Open the Database Manager application by double-clicking on the Database Manager icon.

The application displays the Main Menu.

3. From the Main Menu, make the following selections:

- ↳ **Group**
 - ↳ **Edit**
 - ↳ **Add Entry**

The utility displays a form in which you can enter the group information.

4. Fill in the Group Name, Group ID, and Member list fields, and click on Add.

The application saves the information and creates the group entry.

5. Click in the upper left-hand corner of the window to exit.

The utility returns to the desktop.

Adding a Member to a Group

Use the following procedure to add a member to an existing group.

1. **Start the admintool by entering**

```
admintool <Enter>
```

The utility displays the Administration application icons.

2. **Open the Database Manager application by double-clicking on the Database Manager icon.**

The application displays the Main Menu.

3. **From the Main Menu, make the following selections:**

☞ **Group**

☞ **Edit**

The utility displays a form in which you can enter the group information.

4. **Add the member to the Member list field and click on Add.**

The application saves the new information.

5. **Click in the upper left-hand corner of the window to exit.**

The utility returns to the desktop.

Exporting a File System on Solaris

Use the `share` command to grant the NetWare® server the required authorization to access a specific file system. Refer to the following sections for detailed procedures.

Using the `share` Command to Export a File System

Before a NetWare client can access a file system on an NFS server, you need to list the file system's mount path and identify those clients allowed access to the files. You export a file system by using the following command:

```
share -F nfs -o [option1, option2, option3] /  
          filesystem
```

The options are as follows:

-anon

This option specifies if anonymous (not known to the system) users (NFS UID is -2 and GID is -2) can access the file system. If `anon` is not specified, the default is yes. If `anon` is specified, the default is No.

-ro

This option specifies that the directory be exported in read-only format. If this option is not specified, the directory is exported as read-write.

```
-root=hostname1[:hostname2 [:hostname3]...]
```

This option specifies the hosts whose root user can access the file system. If this option is not specified, root UID 0 receives the rights of the NetWare class NOBODY, in effect granting the privileges of the UNIX user class "others" to root.

hostname specifies the clients allowed access to a file system. If this option is not specified, any client can access the file system. Replace *hostname* with the name of the NetWare server's hostname. If more than one client is listed, separate each name with a colon.

```
-rw:hostname
```

This option specifies that the directory be exported to the specified host for reading and writing. This option overrides the `-ro` option. If no hostname is given, the directory is exported read-write to all.

For *filesystem*, specify the path using UNIX conventions (pathnames are case sensitive). Here is an example of a path in UNIX:

```
/nfs1/users
```

Examples

Here is an example of the `share` command:

```
share -F nfs -o -access=sunrise:ca:na,  
      -root=sunrise, -ro, -rw:sunrise, -anon  
      /nfs1/project2
```

In this example, the NFS server's directory file system to be accessed is `/nfs1/project2`. The clients that can access the file system are "sunrise," "ca," and "na." The superuser on sunrise also has root privileges in the `/nfs1/project2` file system. The clients "ca" and "na" have "read only" permission of the file system, but "sunrise" has "read and write" permission. Anonymous users (classified as NOBODY or NOGROUP) are not allowed to access the file system.

Mounting a File System from a Solaris Machine

Grant the required authorization to mount a remote file system by entering the appropriate entry in the NFS server's `/etc/fstab` file. An entry in the `fstab` file causes the server to mount the remote file system automatically each time the server starts. If you want to mount a file system immediately, you can do so by using the `mount` command. Refer to the following sections for detailed procedures.

Note: The Solaris* system must be running the `portmap`, `nfsd`, and `mountd` daemons to successfully mount a file system.

Setting Up the /etc/fstab File

Use the `etc/fstab` file to specify the remote file systems you want mounted. Create `fstab` entries using the following format.

```
remote_host:/remote_filesystem mount_point  
[option1, [option2, ] ... ]
```

For example, if you want the file system `/vol1/docs` to automatically mount from NetWare® server `sjf-argos` to the local mount point `/newdocs/documents`, you would create the following entry:

```
sjf-argos:/vol1/docs /newdocs/documents
```

For a detailed description of the options, refer to the Solaris documentation on the `fstab` file.

Using the mount Command

If you want to mount a file system immediately, you can use the `mount` command as follows:

```
mount -t nfs server_name:/remote_filesystem /  
mount_point
```

For example, if you want to mount the remote file system `/vol1/docs` from the NetWare server named `sjf-argos` onto the local mount point `/newdocs/documents`, you would type

```
mount -t nfs sjf-argos:/vol1/docs /newdocs/documents
```

For a detailed description of the options, refer to the Solaris documentation on the `mount` command.

Printing on Solaris

The procedures in this section describe what you need to do at the UNIX* host before you can use the NetWare® bidirectional printing.

UNIX-to-NetWare Printing

Remote computers supporting LPR protocol can print to NetWare printers using the UNIX-to-NetWare print service. In addition to setting up this print service as described in “Managing Print Services” on page 172, you must configure your Solaris* host as follows.

Use this procedure to configure the Solaris system:

- 1. Log in to the UNIX host as root by typing**

```
root <Enter>
```

The host prompts you for the root account’s password.

- 2. Type the password for the root account and press <Enter>.**

The host logs you in to the system as root and displays the desktop.

- 3. If the NetWare server is not listed in the /etc/hosts file on your Solaris host, do the following:**

- 3a. Start the system administration utility from the shell tool by typing**

```
admintool <Enter>
```

The utility displays the administration application icons.

- 3b. Start the Database Manager application by double-clicking on the Database Manager icon.**

The application displays the Main Menu.

3c. From the Main Menu, make the following selections:

↳ **Hosts**

↳ **Edit**

↳ **Add Entry**

The utility displays a form in which you can enter the host information.

3d. Enter the name and address of the NetWare server into the Host Name and IP Address fields and click on Add.

The application saves the information and creates the host entry.

3e. Click on the Printer Manager.

The Utility displays the Printer Manager window.

3f. Click the Edit button.

The utility displays the Edit menu.

3g. Select the Add Access to Remote Printer option.

The utility displays the Access to Remote Printer pop-up window.

3h. Fill out the form with the following information:

- ◆ Printer Name—the name of the NetWare print queue.
- ◆ Printer Server—the name of the NetWare Server:
- ◆ Comment—descriptive information to identify the printer.
- ◆ Printer Server OS—type of UNIX system capability on the NetWare server. Choose BSD.
- ◆ System Default—whether the system defaults to the remote printer. The default is No.

3i. Click the Add button to save the information.

3j. Click in the upper left-hand corner of the window to exit.

The application returns to the desktop.

3k. Click on the abbreviated window menu button and select Quit to exit the Printer Manger.

- 3l. **Try printing to the NetWare printer with the following command:**

```
lp -d NetWare_printer_name filename
```

- 3m. **Examine the NetWare queue on the NetWare server by typing the following command:**

```
lpstat NetWare_queue
```

NetWare-to-UNIX Printing

Use this product to configure the UNIX host so NetWare users can spool print jobs to the UNIX printer.

1. **Log in to the UNIX host as root by typing**

```
root <Enter>
```

The host prompts you for the root account's password.

2. **Type the password for the root account and press <Enter>.**

The host logs you into the system as root and displays the desktop.

3. **Start the system administration utility from the shell tool by typing:**

```
admintool <Enter>
```

The utility displays the administration application icons.

4. **To add the NetWare server to the /etc/hosts file on your Solaris host, do the following:**

- 4a. **Start the Database Manager application by clicking on the Database Manager icon.**

The application displays the Load Database window.

4b. From the Load Database window, make the following selections:

- ↳ **Hosts**
- ↳ **Edit**
- ↳ **Add Entry**

The utility displays a form in which you can enter the host information.

4c. Enter the name and address of the NetWare server into the Host Name and IP Address fields and click on Add.

The application saves the information and creates the host entry.

5. In the Admintool window, start the Printer Manager application by clicking on the Printer Manager icon.

The Utility displays the Printer Manager window.

6. In the Printer Manager Window, create a configuration for a new printer as follows:

- ↳ **Edit**
- ↳ **Add Printer**
- ↳ **Add Local Printer**

The utility display a form to configure the printer.

7. Fill in the configuration details.

The required fields are Printer Name, Printer Port, Printer Type, and File Contents.

8. After filling the entries, click the “Add” button, then close the Local Printer window.

The printer configuration is saved and the printer is added to the list of local printers.

9. In the Printer Manager window, select (highlight) the printer you just created.

10. Modify the printer as follows:

↳ **Edit**

↳ **Modify Printer**

The utility display a form to modify the printer.

11. For Print Server OS, choose BSD.

12. Click Apply, then close the Modify Printer window.

13. To test if the local printer is configured properly, spool a job locally from the Solaris host using the following command:

```
lpr -P printer_name filename
```

14. After using UNICON to configure the NetWare print queue to print to this printer, log in to the NetWare server and try printing to the UNIX printer by entering the following command:

```
NPRINT filename /q=queue
```

Troubleshooting

If problems occur when trying to send jobs from NetWare to Solaris*, use the `tabs` option in either the `CAPTURE` command or the `NPRINT` command to force the job to be sent in text format instead of as a byte stream.

For other troubleshooting purposes, examine the following lp log files for clues:

```
/var/spool/lp/logs/lpNet
```

```
/var/spool/lp/logs/lpsched
```

SunOS Administration Procedures

Use this section to configure your SunOS* system to function with NetWare®.

Complete the following procedures as necessary:

- ◆ “Determining if NIS is in Use on SunOS” on page 424
- ◆ “Obtaining User, Group, and Host Information from NIS on SunOS” on page 424
- ◆ “Determining if DNS is in Use on SunOS” on page 425
- ◆ “Logging in as Root on SunOS” on page 425
- ◆ “Identifying Your NetWare Server for SunOS” on page 426
- ◆ “Finding Information About a User on SunOS” on page 427
- ◆ “Creating a User Account and Setting a Password on SunOS” on page 429
- ◆ “Finding Information About Groups on SunOS” on page 430
- ◆ “Creating a SunOS Group” on page 431
- ◆ “Exporting a File System on SunOS” on page 433
- ◆ “Mounting a File System from a SunOS Machine” on page 435
- ◆ “Printing on SunOS” on page 436

Determining if NIS is in Use on SunOS

To determine if your AIX* system is using NIS, enter the following command:

```
ypwhich <Enter>
```

If the command returns a domain name, the system is using NIS to store user and group information. If the command returns a message similar to the following:

```
ypwhich: host not running ypbind
```

or

```
ypwhich: the domainname hasn't been set on this machine
```

then the system is storing user and group information in local files.

Obtaining User, Group, and Host Information from NIS on SunOS

If your system is using NIS and you want your NetWare® server to use (point to) the NIS database on the UNIX* host, enter the NIS domain name and server address in the appropriate Server Profile fields. For more information on using a non-NetWare NIS server, see “Using a Non-NetWare Server as the NIS Master” on page 222.

If your system is using NIS and you want to transfer user, group, and host information from your UNIX host to the NetWare server, you must first create files from the NIS database. The following commands create these files:

```
ypcat hosts > hosts <Enter>
ypcat passwd > passwd <Enter>
ypcat group > group <Enter>
```

You can now transfer files to the NetWare server using the UNICON utility's FTP function (see “Copying a File from a Remote Host” on page 240).

When the files are larger than 64 KB, you cannot use the edit file function available through the UNICON utility to remove unwanted entries. If any of your files are too large, use a DOS editor or remove the unwanted entries before you transfer the file from the UNIX system to the NetWare server.

Determining if DNS is in Use on SunOS

To determine if your UNIX* system is using DNS to store host information, search for the resolv.conf file located in the /etc directory. If this file exists, your system is using DNS. Otherwise, your system is using a different method to store host information.

If your system is using DNS and you want your NetWare® server to use (point to) the DNS host database on the UNIX host, enter the domain name and server address contained in the resolv.conf file in the appropriate fields of the Server Profile form.

Logging in as Root on SunOS

Before you can perform any UNIX* administration task, you must log in to the UNIX host using the administration account (root). The following procedure assumes that you have access to the UNIX host's system console and the root password before you log in to the host.

1. **Log in to the UNIX host as root by entering the following command:**

```
root <Enter>
```

The host prompts you for the root account's password.

2. **Type the password for the root account and press <Enter>.**

The host logs you in to the system as root and displays the command prompt.

Identifying Your NetWare Server for SunOS

The UNIX* host needs to know about other computers with which it communicates. You inform the UNIX host of new computers by editing a file named `hosts`. This file is stored in the `/etc` directory.

The `hosts` file contains two information fields:

- ◆ The IP address field, which contains the hosts's IP address formatted as a series of four integers separated by periods.
- ◆ The host name field, which contains the host's official name.

The following example shows several entries from a `hosts` file:

```
192.53.4.1 tulip
192.53.3.6 chaos
192.53.5.12 newyork ny nyc
```

Important: Your NetWare® server could have two names. The first name—which is specified in the `AUTOEXEC.NCF` file—is the name used by DOS, OS/2*, and Macintosh* users to connect to the server. The second name—which is specified in the server's `hosts` database—is the name used by the NetWare server. Use the name specified in the `hosts` database in the following procedure.

1. **Use an editor to open the UNIX `hosts` file.**
2. **Create a new entry for the NetWare server by typing the IP address, a space, and the server's hostname**
3. **Save the edited `hosts` file and exit the editor.**

Finding Information About a User on SunOS

For each NetWare® user accessing NFS files through the NetWare server, you need to know the user's user identification number (UID) and the group identification number (GID) of the user's primary login group.

This information is stored in the passwd file. This file is stored in the /etc directory. You can transfer the passwd file to the NetWare server using the UNICON utility's FTP function (see "Copying a File from a Remote Host" on page 240) or manually obtain the information for each user as described in the following section.

Finding User Information with a UNIX Account Name

You can use the grep command to display a user's information, as shown in the following command:

```
grep username /etc/passwd <Enter>
```

You replace *username* with the user's UNIX account name. The following example shows the syntax for finding information about a user named *joeuser*:

```
grep joeuser /etc/passwd <Enter>
```

```
joeuser:qz0gGcQdTB5zk:1848:720:Joseph User:/home/  
joeuser:/bin/csh
```

User information is displayed in seven fields. Each field is separated by a colon (:). The fields contain the following information:

- ◆ The first field contains the user's account name.
- ◆ The second field contains the user's password in an encrypted format.
- ◆ The third field contains the user's UID.
- ◆ The fourth field contains the user's primary GID.
- ◆ The fifth field contains the user's full name.

- ◆ The sixth field contains the user's home directory.
- ◆ The seventh field contains the path and name of the UNIX shell the system runs when the user logs in to the host.

Finding User Information with a User's Full Name

If you do not know a user's account name, you might be able to use the `grep` command and the user's full name to find the user information. The following command is an example of how you could find the entry for the `joeuser` account using the name "Joe User":

```
grep 'Joe User' /etc/passwd <Enter>
```

The output from this example would be identical to the output from the previous example.

Compiling a List of User Names with UIDs and Primary GIDs

If your UNIX host has a large `passwd` file, you might want to create a file containing a listing of every user and the user's corresponding UID and GID. You can create this list using the `awk` command.

The following example creates a file containing a three-column list of user names, UIDs, and GIDs. The list is stored in the host's `/tmp` directory.

```
awk '{FS=":";print $1,$3,$4}' /etc/passwd /tmp/  
userinfo <Enter>
```

The file that results from the example contains a listing that looks like the following:

```
root 0 1
nobody 65534 65534
daemon 1 1
bin 3 3
joeuser 1848 720
```

Creating a User Account and Setting a Password on SunOS

Create a new user account by running a script named `add_user`. The script is stored in the directory named `/usr/etc/install`.

Creating a User Account

Each user must have a unique UID. To obtain a list of current users by UID number, enter

```
sort -t: +2 -3 -n /etc/passwd | more
```

When you run the `add_user` script, you must supply the following information:

- ◆ The user name for the account
- ◆ The user UID you want to assign to the user
- ◆ The primary group identification number (GID) you want to assign to the user
- ◆ The user's full name in quotation marks ("")
- ◆ The full path to the user's home directory
- ◆ The full path and name of the shell to execute when the user logs into the host (usually `/bin/csh` or `/bin/sh`)

The following example shows how to create an account for Joe User:

```
add_user joeuser 497 126 "Joe User" /home/joeuser /  
bin/csh <Enter> <Enter>
```

After you create a user, you need to add the user to the appropriate group(s). For instructions on adding a user to a group, see “Adding a Member to a Group” on page 432.

Setting a Password for the New Account

When you use the `add_user` script to add a user, the script adds the user’s account entry to the `/etc/passwd` file and creates the home directory, including some necessary files.

The user entry in the `/etc/passwd` directory does not include a password. After you add the user account, run the `passwd` command and set a default password for the new account. The format for setting a password for Joe User’s account is shown in the following:

```
passwd joeuser
```

The system prompts you to enter the new password and reenter it to verify you typed it correctly. The `/etc/passwd` file is updated to include the encrypted version of the password.

Finding Information About Groups on SunOS

Each group defined on the UNIX host has a listing in a file named `group`. This file is stored in the `/etc` directory. You can transfer the group file to the NetWare server using the UNICON utility’s FTP function (see “Copying a File from a Remote Host” on page 240) or obtain the information for each group manually as described in the following paragraphs.

Compiling a List of Groups and GIDs

You can compile a list of group names and group identification numbers using the `awk` command.

The following example creates a file containing a two-column list of group names and GIDs. The list is stored in the host's /tmp directory.

```
awk '{FS=":";print $1,$3}' /etc/group /tmp/  
groupinfo <Enter>
```

The file that results from the example contains a listing that looks like the following:

```
wheel 0  
daemon 1  
operator 2
```

Creating a SunOS Group

The information about UNIX* groups is stored in the /etc/group file. To create a new group, you add a new group entry to this file.

Setting Up the /etc/group File

To create a new group, use a text editor to open the group file and insert information about the group.

The group file consists of four fields:

- ◆ Group name field
- ◆ Group password field
- ◆ GID
- ◆ List of users who are members of the group

Each field is separated from the next by a colon (:). Group members names are separated by commas (,).

Following is a sample entry from the group file:

```
wheel*:0:daemon,root
```

Each group must have a unique GID. The asterisk in the password field means members cannot use the `newgrp` command to temporarily switch their primary group association to that of the group.

1. **Use an editor to open the group file.**
2. **Create an entry for the new group as shown in the previous example.**
3. **Save the edited group file and exit the editor.**

Adding a Member to a Group

The information about UNIX groups is stored in the `/etc/group` file. You can add a user to a group by using a text editor to open the file and insert the information about the new members.

The group file consists of four fields listed in the previous section. Each field is separated from the next by a colon (:). The fourth field contains the group members. Group members names are separated by commas (,).

The following example shows an example of an entry from the group file. The group members are “arnolds” and “bdover”.

```
newgroup*:902:arnolds,bdover
```

1. **Use an editor to open the group file.**
2. **Add the new member to the last field of the appropriate group entry as described in the section titled “Setting Up the `/etc/group` File” on page 392.**
3. **Save the edited group file and exit the editor.**

Exporting a File System on SunOS

Grant the NetWare® server the required authorization to access a specific file system by entering the appropriate entry in the NFS server's `/etc/exports` file. Refer to the following sections for detailed procedures.

Setting Up the `/etc/exports` File

Before a NetWare client can access a file system on a NFS server, the file system's mount path and those clients allowed access to the files must be entered. You make this entry in the `/etc/exports` file, which resides on the NFS server. This entry has the following syntax:

```
filesystem [ option1 [ option2 ] ... ]
```

For *filesystem*, specify the path using UNIX* conventions (pathnames are case sensitive). Here is an example of a path in UNIX:

```
/nfs1/users
```

The *options* can be any logical combination of the following. Use a comma to separate options.

```
-access=client1[:client2 [:client3]. . . ]
```

This option identifies which clients are allowed to access a file system. If this option is not specified, any client can access the file system. Replace *client* with the NetWare server's hostname. If more than one client is listed, separate each name with a colon.

```
-anon
```

This option specifies if anonymous (not known to the system) users (NFS UID is `-2` and GID is `-2`) can access the file system. If `anon` is not specified, the default is Yes. If `anon` is specified, the default is No.

```
-ro
```

This option specifies the directory be exported in read-only format. If this option is not specified, the directory is exported as read-write.

```
-root=hostname1[:hostname2 [:hostname3]...]
```

This option specifies which users can access the file system. If this option is not specified, root UID 0 receives the rights of the NetWare class NOBODY, granting the privileges of the UNIX user class “others” to root.

Replace *hostname* with the name of the NetWare client. If more than one client is listed, separate each name with a colon.

```
-rw:hostname
```

This option specifies the directory to be exported to the specified host for reading and writing. This option overrides the `-ro` option. If no hostname is given, the directory is exported read-write to all.

Examples

Here is an example of an entry in the exports file:

```
# "Exported Path", "Trusted Systems"  
/nfs1/project2 -access=sunrise:ca:na,  
-root=sunrise, -ro, -rw:sunrise, -anon
```

In this example, the NFS server's directory file system to be accessed is `/nfs1/project2`. The clients accessing the file system are “sunrise,” “ca,” and “na.” The superuser on sunrise also has root privileges in the `/nfs1/project2` file system. The clients “ca” and “na” have “read only” access to the file system, but “sunrise” has “read and write” permission. Anonymous users (classified as NOBODY or NOGROUP) are not allowed to access the file system.

```
/nfs1/project3 -ro
```

In this example, all clients can access the file system `/nfs1/project3` with “read only” permission, and all NetWare users with a UID of 0 are granted privileges equivalent to the NetWare user NOBODY.

Effecting Changes to exports File

If you add an entry in the `/etc/exports` file, the changes do not take effect until you enter the following command:

```
exportfs -a
```

Mounting a File System from a SunOS Machine

Grant the required authorization to mount a remote file system by entering the appropriate entry in the NFS server's `/etc/fstab` file. An entry in the `fstab` file causes the server to mount the remote file system automatically each time the server starts. If you want to mount a file system immediately, you can do so by using the `mount` command. Refer to the following sections for detailed procedures.

Note: The Sun* system must be running the `portmap`, `nfsd`, and `mountd` daemons to successfully mount a file system.

Setting Up the `/etc/fstab` File

Use the `etc/fstab` file to specify the remote file systems you want mounted. Create `fstab` entries using the following format:

```
remote_host:/remote_filesystem mount_point  
[option1, [ option2, ] ... ]
```

For example, if you want the file system `/vol1/docs` to automatically mount from NetWare® server `sjf-argos` to the local mount point `/newdocs/documents`, you would create the following entry:

```
sjf-argos:/vol1/docs /newdocs/documents
```

For a detailed description of the options, refer to the SunOS* documentation on the `fstab` file.

Using the mount Command

If you want to mount a file system immediately, you can use the mount command as follows:

```
mount -t nfs server_name:/remote_filesystem /  
mount_point
```

For example, if you want to mount the remote file system /vol1/docs from NetWare server sjf-argos to the local mount point /newdocs/documents, you would type

```
mount -t nfs sjf-argos:/vol1/docs /newdocs/documents
```

For a detailed description of the options, refer to the SunOS documentation on the mount command.

Printing on SunOS

The procedures in this section describe what to do at the UNIX* host to use NetWare® bidirectional printing.

This section assumes you are running SunOS* v4.1.x. Earlier versions may not contain the functionality as described in the following:

Prerequisites

Before you proceed, verify the lpd daemon is running on the UNIX host by issuing the following command:

```
ps aux | grep lpd
```

If the lpd daemon is running, you should see output similar to:

```
root 8389 0.0 0.0 52 0 ? IW 02:37 0:01  
/usr/lib/lpd
```

If the lpd daemon is not running, start the daemon by logging in to the UNIX host as root and entering the following command:

```
/usr/lib/lpd
```

Verify the daemon is running by using the `ps` command described in the preceding.

To start the `lpd` daemon automatically when the system starts, make sure an entry like the following is in the `/etc/rc` file:

```
if [ -f /usr/lib/lpd ]; then
    rm -f /dev/printer /var/spool/lpd.lock
    /usr/lib/lpd;          echo -n ' printer'
fi
```

Printcap File Format

Many operating systems, including SunOS, use a printcap (printer capability) file to configure local and remote printing. The file has an entry for each printer in the following format (for information on additional options, enter “`man printcap`” at the UNIX prompt):

```
printer_name1 | printer_name2 | printer_nameN | \  
: printer_description : lp=print_device_name : \  
: rm=netware_server_name : \  
: rp=netware_print_queue_name : \  
: sd= /user/spool/spool_directory : mx#file_size \  
: rs :
```

Where

printer_name1, *printer_name2*, ... *printer_nameN*—names used by UNIX users to refer to this printer.

printer_description—a text string describing the printer in more detail (for example: “Laser printer on first floor”).

print_device_name—name of a print device on the local UNIX machine (for example, “`lp=/dev/lp`”). When printing to a printer on a remote machine, *print_device_name* should be the null character (for example, “`lp=`”).

netware_server_name—name of the NetWare server accepting print jobs. This should be the name listed in the `/etc/hosts` file on the UNIX host for the NetWare server.

netware_print_queue_name—name of the remote NetWare print queue. This entry is not case sensitive.

spool_directory—name of the spool directory on the local UNIX machine. This is where print jobs are temporarily stored before they are printed. You must manually create this directory (for example: as root, type at the UNIX prompt “`mkdir /usr/spool/spool_directory`”). It is customary to give *spool_directory* the same value as *netware_print_queue_name*.

#file_size—the maximum size (measured in blocks) of a file that can be spooled to the printer. If *file_size* = 0, files of unlimited size can be spooled to the printer.

rs—remote users can use this printer only if they have a local account on the system. Omitting the *rs* parameter enables any remote user on a “trusted host” to use this printer.

UNIX-to-NetWare Printing

Remote computers supporting the LPR protocol can print to NetWare printers by using the UNIX-to-NetWare print service. To configure your UNIX host so users can spool print jobs to the print queue on the NetWare server, perform the following procedure:

1. **Log in to your UNIX host as root.**
2. **Use a text editor to add the printer entry to the `/etc/printcap` file.**
3. **Create a spool directory by entering the following command at the UNIX prompt:**

```
mkdir /usr/spool/queue
```

where *queue* is the exported queue you create on the NetWare server for access by remote users.

4. **Try printing to the NetWare printer by entering the following command:**

```
lpr -dprinter filename
```

5. **Examine the NetWare print queue on the NetWare server by entering the following command:**

```
lpq printer
```

NetWare-to-UNIX Printing

Use this product to configure the UNIX host so NetWare users can spool print jobs to the UNIX printer:

1. **Log in to your Sun host as root.**
2. **Use a text editor to add the printer entry to the `/etc/printcap` file.**
3. **Create a spool directory by entering the following command at the UNIX prompt:**

```
mkdir /usr/spool/queue
```

where *queue* is the exported queue you create on the NetWare server for access by remote users.

4. **Use a text editor to add the name of the NetWare server to the `/etc/hosts.lpd` file.**

This entry allows the NetWare server to spool print jobs to your UNIX host.

5. **Log in to the NetWare server and try printing to the UNIX printer by entering the following command:**

```
NPRINT filename /q=queue
```

System V Administration Procedures

Use this section to configure your system to function with NetWare®.

Complete the following procedures as necessary:

- ◆ “Determining if NIS is in Use on System V” on page 441
- ◆ “Obtaining User, Group, and Host Information from NIS on System V” on page 441
- ◆ “Determining if DNS is in Use on System V” on page 442
- ◆ “Logging In as Root on System V” on page 442
- ◆ “Identifying Your NetWare Server for System V” on page 443
- ◆ “Finding Information About a User on System V” on page 444
- ◆ “Creating a User Account and Setting a Password on System V” on page 447
- ◆ “Finding Information About Groups on System V” on page 449
- ◆ “Creating a System V Group” on page 450
- ◆ “Exporting a File System on System V” on page 452
- ◆ “Mounting a File System from a System V Machine” on page 453
- ◆ “Printing on System V” on page 454

Determining if NIS is in Use on System V

To determine if System V™ is using NIS, enter the following command:

```
ypwhich <Enter>
```

If the command returns a domain name, the system is using NIS to store user and group information. If the command returns a message similar to the following:

```
ypwhich: host not running ypbind
```

or

```
ypwhich: the domainname hasn't been set on this  
machine
```

then the system is storing user and group information in local files.

Obtaining User, Group, and Host Information from NIS on System V

If your system is using NIS and you want your NetWare® server to use (point to) the NIS database on the UNIX* host, enter the NIS domain name and server address in the appropriate Server Profile fields. For more information on using a non-NetWare NIS server, see “Using a Non-NetWare Server as the NIS Master” on page 222.

If your system is using NIS and you want to transfer user, group, and host information from your UNIX host to the NetWare server, you must first create files from the NIS database. The following commands create these files:

```
ypcat hosts > hosts <Enter>  
ypcat passwd > passwd <Enter>  
ypcat group > group <Enter>
```

You can now transfer files to the NetWare server using the UNICON utility's FTP function (see “Copying a File from a Remote Host” on page 240).

When the files are larger than 64 KB, you cannot use the edit file function available through the UNICON utility to remove unwanted entries. If any of your files are too large, either use a DOS editor or remove the unwanted entries before you transfer the file from the UNIX system to the NetWare server.

Determining if DNS is in Use on System V

To determine if your system is using DNS to store host information, search for the `resolv.conf` file located in the `/etc` directory. If this file exists, your system is using DNS. Otherwise, your system is using a different method to store host information.

If your system is using DNS and you want your NetWare® server to use (point to) the DNS host database on the UNIX* host, enter the domain name and server address contained in the `resolv.conf` file in the appropriate fields of the Server Profile form.

Logging In as Root on System V

Before you perform a UNIX* administration task, you must log in to the UNIX host using the administration account (root). The following procedure assumes you have access to the host's system console and the root password before you log in to the host.

1. **Log in to the UNIX host as root by entering the following command:**

```
root <Enter>
```

The host prompts you for the root account's password.

2. **Type the password for the root account and press <Enter>.**

The host logs you in to the system as root and displays the command prompt.

Identifying Your NetWare Server for System V

The UNIX* host needs to know about other computers with which it communicates. Inform the UNIX host of new computers by using the `sysadm` administration utility.

The host information consists of the following:

- ◆ The IP address consists of a host's IP address formatted as a series of four integers separated by periods.
- ◆ The host name consists of a host's official name.

To identify your NetWare server, do the following:

1. Start the system administration utility by typing

```
sysadm <Enter>
```

The utility displays the Main Menu.

2. From the Main Menu, make the following selections:

```
↳ network_services
   ↳ name_to_address
     ↳ inet
       ↳ hosts
```

The utility displays a form for adding host information.

3. Fill in the Name and IP address fields and press <F3> to save the information.

The utility displays a message confirming the addition of the new host.

4. Press <F6> to exit the screen.

The utility displays the previous screen.

Finding Information About a User on System V

For each NetWare® user accessing NFS files through the NetWare server, you need to know both the user's user identification number (UID) and the group identification number (GID) of the user's primary login group.

This information is stored in the passwd file. This file is stored in the /etc directory. You can transfer the passwd file to the NetWare server using the UNICON utility's FTP function (see "Copying a File from a Remote Host" on page 240) or manually obtain the information for each user as described in the following section.

Finding User Information Using the Administration Tool

You use this procedure to display a list of users and their UIDs.

1. **Start the system administration utility by entering the following command:**

```
sysadm <Enter>
```

The utility displays the Main Menu.

2. **From the Main Menu, make the following selections:**

```
⇒ users
  ⇒ list
    ⇒ user
```

3. **Press <F3>.**

The utility lists the users and their assigned UIDs.

4. **Press <F6> to exit the screen.**

The utility displays the previous menu.

Finding User Information with an Account Name

You can use the `grep` command to display a user's information, as shown in the following command:

```
grep username /etc/passwd <Enter>
```

You would replace *username* with the user's UNIX account name. The following example shows the syntax for finding information about a user named *joeuser*:

```
grep joeuser /etc/passwd <Enter>
```

```
joeuser:qzogGcQdTB5zk:1848:720:Joseph User:/home/  
joeuser:/bin/csh
```

User information is displayed in seven fields. Each field is separated by a colon (:). The fields contain the following information:

- ◆ The first field contains the user's account name.
- ◆ The second field contains the user's password in an encrypted format.
- ◆ The third field contains the user's UID.
- ◆ The fourth field contains the user's primary GID.
- ◆ The fifth field contains the user's full name.
- ◆ The sixth field contains the user's home directory.
- ◆ The seventh field contains the path and name of the UNIX shell the system runs when the user logs in to the host.

Finding User Information with a User's Full Name

If you do not know a user's account name, you might be able to use the `grep` command and the user's full name to find the user information. The following command is an example of how you could find the entry for the `joeuser` account using the name "Joe User":

```
grep 'Joe User' /etc/passwd <Enter>
```

The output from this example would be identical to the output from the previous example.

Compiling a List of User Names with UIDs and Primary GIDs

If your UNIX host has a large `passwd` file, you might want to create a file containing a listing of every user and the user's corresponding UID and GID. You can create this list using the `awk` command.

The following example creates a file containing a three-column list of user names, UIDs, and GIDs. The list is stored in the host's `/tmp` directory.

```
awk '{FS=":";print $1,$3,$4}' /etc/passwd /tmp/  
userinfo <Enter>
```

The file that results from the example contains a listing that looks like the following:

```
root 0 1  
nobody 65534 65534  
daemon 1 1  
bin 3 3  
joeuser 1848 720
```

Creating a User Account and Setting a Password on System V

Use the system administration utility to create an account for a new user.

To create a user, you need the following information:

- ◆ User's full name (in the comments field)
- ◆ User's user name (in the Login field)
- ◆ User's UID (The User ID field)
- ◆ User's primary GID (in the Primary Group field)

Important: Although the form you use to add a user contains additional fields, only those listed in the preceding are necessary to create a new user. If you want further information about any of the other fields, highlight the field and press <F1>.

If a user already exists on another UNIX* machine, create the user using the same UID and GID as on the existing system.

Each user must have a unique UID. To obtain a list of the current users along with their UID and primary GID, refer to "Compiling a List of User Names with UIDs and Primary GIDs" on page 446.

Creating a User Account

You use the following procedure to create a user account.

1. **Start the administration utility by entering the following command:**

```
sysadm <Enter>
```

2. From the Main Menu, make the following selections:

- ⇒ users
- ⇒ add
- ⇒ user

3. Press <F3>.

The utility displays a form for adding the new user information.

4. Fill in the Comments, Login, and Primary Group fields.

The utility automatically assigns the next available UID or you can enter a different UID.

5. Press <F3> to save the user information.

The utility saves the information, creates the new user, and displays a password information form. You do not need to modify this form.

6. Press <F3> to exit the screen.

The utility returns to the previous menu.

7. Press <F3> to add another user, or press <F6> to exit.

If you press <F6>, the utility returns to the previous menu.

After you create a user, you need to add the user to the appropriate group(s). For instructions on adding a user to a group, see “Adding a Member to a Group” on page 451.

Setting a Password for the New Account

When you create a user using the sysadm tool, the user’s account entry is created and added to the `/etc/passwd` file, the home directory is created, and some necessary files are placed in the home directory.

The `sysadm` utility creates a user entry in the `/etc/passwd` directory WITHOUT a password. After you create the user entry, you should run the `passwd` command and set a default password for the new account. The format for setting a password for Joe User's account is shown in the following::

```
passwd joeuser
```

The system asks you to enter a new password, and to reenter the password to verify you typed it correctly. The `/etc/passwd` file is updated to include the encrypted version of the password, and the account cannot be used to log in to the host unless the correct password is typed.

Finding Information About Groups on System V

Each group defined on the UNIX* host has a listing in a file named `group`. This file is stored in the `/etc` directory. You can transfer the group file to the NetWare® server using the UNICON utility's FTP function (see "Copying a File from a Remote Host" on page 240) or obtain the information for each group manually as described in the following paragraphs.

Compiling a List of Groups and GIDs

You can compile a list of group names and group identification numbers using the `awk` command.

The following example creates a file containing a two-column list of group names and GIDs. The list is stored in the host's `/tmp` directory.

```
awk '{FS=":";print $1,$3}' /etc/group > /tmp/  
groupinfo <Enter>
```

The file created by the example contains a list that looks like this:

```
wheel 0  
daemon 1
```

Displaying a List of Groups and GIDs

Use the following procedure to display a list of groups and their GIDs.

1. **Start the system administration utility by entering the following command:**

```
sysadm <Enter>
```

The utility displays the Main Menu.

2. **From the Main Menu, make the following selections:**

```
↳ Users
  ↳ list
    ↳ group
```

3. **Press <F3>.**

The utility displays a list of all the groups and their assigned GIDs.

4. **Press <F6> to exit the screen.**

The utility returns to the previous menu.

Creating a System V Group

The information about UNIX groups is stored in the `/etc/group` file. To create a new group, use the administration utility `sysadm`.

To create a group, you need the following information:

- ◆ Group name
- ◆ GID
- ◆ Primary members of the group

Note: Although the form used to add a group contains additional fields, only those listed in the preceding are necessary to create a new group. If you want further information about any of the other fields, highlight the field and press `<F1>`.

Creating a Group

Use the following procedure to create a group.

1. **Start the administration utility by entering the following command:**

```
sysadm <Enter>
```

The utility displays the Main Menu.

2. **From the Main Menu, make the following selections:**

```
⇒ users
  ⇒ add
    ⇒ group
```

3. **Press <F3>.**

The utility displays a form for adding information about the new group.

4. **Fill in the Group name and Primary members fields.**

The utility automatically assigns the next available GID or you can enter a different one.

5. **Press <F3> to save the information.**

The utility saves the information and creates the new group.

6. **Press <F3> to add another group or press <F6> to exit the screen.**

If you press <F6>, the utility displays the previous menu.

Adding a Member to a Group

Use the following procedure to add a member to a group.

1. **Start the administration utility by entering the following command:**

```
sysadm <Enter>
```

The utility displays the Main Menu.

2. **From the Main Menu, make the following selections:**

- ↳ users
- ↳ modify
- ↳ group

3. **Press <F3>.**

The utility prompts for the name of the group.

4. **Type the name of the group and press <F3>.**

The utility displays the group form.

5. **Add the new member to the Primary members field and press <F3> to save the information.**

The utility saves the information and exits the form.

6. **Press <F6> to exit the screen.**

The utility displays the previous menu.

Exporting a File System on System V

Before a NetWare® client can access a file system on an NFS server, you need to list the file system's mount path and identify those clients allowed access to the files.

Note: The UNIX system must be running the portmap, nfsd, and mountd daemons to successfully export a file system.

Use the following procedure to export a file system.

1. **Start the system administration utility by entering the following command:**

```
sysadm <Enter>
```

The utility displays the Main Menu.

2. **From the Main Menu, make the following selections:**

- ↳ **network_services**
- ↳ **remote_files**
- ↳ **local_resources**
- ↳ **share**
- ↳ **nfs**

The utility displays a form used for exporting (sharing) a file system.

3. **Fill in the directory path field and press <F3> to save the information.**

The utility displays a form for host access information.

4. **Add the NetWare server's hostname to the Root Access Client field and press <F3>.**

The utility exports the file system for access by the NetWare server.

5. **Press <F6> to exit the screen.**

The utility displays the previous screen.

Mounting a File System from a System V Machine

Mount a remote file system by using the `sysadm` administration tool.

Note: The UNIX* system must be running the `portmap`, `nfsd`, and `mountd` daemons to successfully export a file system.

1. **Start the system administration utility by entering the following command:**

```
sysadm <Enter>
```

The utility displays the Main Menu.

2. **From the Main Menu, make the following selections:**

- ↳ **file_systems**

- ↳ **mount**

The utility displays a form used for mounting a remote file system.

3. **Fill in the Device that Contains the File System field and press <F3> to save the information.**

The utility moves to the File System Name When Mounting field.

4. **Fill in the File System Name When Mounting field and press <F3> to save the information.**

The utility mounts the file system for access by NFS users.

5. **Press <F6> to exit the screen.**

The utility displays the previous screen.

Printing on System V

The procedures in this section describe what you need to do at the UNIX* host before you can use the NetWare® bidirectional printing.

UNIX-to-NetWare Printing

Remote computers supporting LPR protocol can print to NetWare printers by using the UNIX-to-NetWare print service. In addition to setting up this print service (as described in “Managing Print Services” on page 172), you need to configure your host machine as follows.

Prerequisites

This procedure assumes you are running System V™ version 4 release 4 from either AT&T*, UNIX System Laboratories (USL™), or from some other vendor supporting SVR4™.

Before you proceed, make sure the following prerequisites are met:

- ◆ The name and IP address of the NetWare server is in the `/etc/hosts` file on your UNIX host.
- ◆ Make sure the port monitor is running by typing the following command:

```
pmadm -l -p tcp -s
```

If the port monitor is ready to accept printer service requests over your network, you should see information like the following:

PMTAG	PMTYPE	SVCTAG	FLGS	ID	<PMSPECIFIC>
tcp	listen	0	-	root	\x02000ACE823904D5 - c - /usr/lib/saf/nlps_server #NLPS SERVER
tcp	listen	lp	-	root	/var/spool/lp /fifos/listenS5 #NLPS SERVER

Verify there is a `SVCTAG=0` and a `SVCTAG=lp`. If not, consult the system administrator's manual for instructions on how to start the port monitor.

Procedure

To configure printing for SVR4.4, complete the following steps.

1. **Log in to your UNIX host as root.**
2. **Register the NetWare server with the local LP print service and define the way they will communicate. Configure LP to print to a BSD-type printer on the NetWare server with the retry parameter set to 5 and timeout set to 10:**

```
lpssystem -t bsd -R 5 -T 10 server_name
```

For more information on the -R and -T options, type “man lpssystem” at the UNIX prompt.

3. **Create a UNIX queue pointing to the NetWare server and NetWare queue. The “-I” parameter allows PostScript, simple and troff file formats.**

```
lpadmin -p UNIX_queue -s NetWare_server  
!NetWare_queue -I simple|postscript|troff"
```

4. **Enable queuing by entering**

```
enable UNIX_queue
```

5. **Accept print requests by entering**

```
accept UNIX_queue
```

6. **Stop and start the LP scheduler by entering**

```
/usr/sbin/lpshut
```

7. **Start the LP scheduler by entering**

```
/usr/lib/lp/lpsched
```

8. **Try printing to the NetWare printer by entering the following command:**

```
lp -d UNIX_queue filename
```

Or, to print the file without the banner page:

```
lp -d UNIX_queue -o nobanner filename
```

9. **Examine the NetWare queue on the NetWare server by entering**

```
lpstat UNIX_queue
```

Troubleshooting

If you have any trouble printing, look in the following LP log files for clues:

- ◆ /var/lp/logs/lpNet
- ◆ /var/lp/logs/lpsched

NetWare-to-UNIX Printing

USL™ SVR4.4 does not allow any machine other than another USL host to print to its locally attached printers. Therefore, NetWare-to-UNIX printing is not possible when the UNIX host is running USL System V™.

ULTRIX Administration Procedures

Use this section to configure your ULTRIX* system to function with NetWare.

Complete the following procedures as necessary:

- ◆ “Determining if NIS is in Use on ULTRIX” on page 459
- ◆ “Obtaining User, Group, and Host Information from NIS on ULTRIX” on page 459
- ◆ “Determining if DNS is in Use on ULTRIX” on page 460
- ◆ “Logging In as Root on ULTRIX” on page 460
- ◆ “Identifying Your NetWare Server for ULTRIX” on page 461
- ◆ “Finding Information About a User on ULTRIX” on page 461
- ◆ “Creating a User Account and Setting a Password on ULTRIX” on page 464
- ◆ “Finding Information About Groups on ULTRIX” on page 465
- ◆ “Creating an ULTRIX Group” on page 466
- ◆ “Exporting a File System on ULTRIX” on page 468
- ◆ “Mounting a File System from an ULTRIX Machine” on page 470
- ◆ “Printing on ULTRIX” on page 471

Determining if NIS is in Use on ULTRIX

To determine if your AIX* system is using NIS, enter the following command:

```
ypwhich <Enter>
```

If the command returns a domain name, the system is using NIS to store user and group information. If the command returns a message similar to the following:

```
ypwhich: host not running ypbind
```

or

```
Domain domainname not bound
```

then the system is storing user and group information in local files.

Obtaining User, Group, and Host Information from NIS on ULTRIX

If your system is using NIS and you want your NetWare® server to use (point to) the NIS database on the UNIX* host, enter the NIS domain name and server address in the appropriate fields of the Server Profile form. For more information on using a non-NetWare NIS server, see “Using a Non-NetWare Server as the NIS Master” on page 222.

If your system is using NIS and you want to transfer user, group, and host information from your UNIX host to the NetWare server, you must first create files from the NIS database. The following commands create these files:

```
ypcat hosts > hosts <Enter>
```

```
ypcat passwd > passwd <Enter>
```

```
ypcat group > group <Enter>
```

You can now transfer the files to the NetWare server using the UNICON utility's FTP function (see “Copying a File from a Remote Host” on page 240).

When the files are larger than 64 KB, you cannot use the edit file function available through the UNICON utility to remove unwanted entries. If any of your files are too large, either use a DOS editor or remove the unwanted entries before you transfer the file from the ULTRIX* system to the NetWare server.

Determining if DNS is in Use on ULTRIX

To determine if your ULTRIX* system is using DNS to store host information, search for the `resolv.cfg` file located in the `/etc` directory. If this file exists, your system is using DNS. Otherwise, your system is using a different method to store host information.

If your system is using DNS and you want your NetWare® server to use (point to) the DNS host database on the UNIX host, enter the domain name and server address contained in the `resolv.conf` file in the appropriate fields of the Server Profile form.

Logging In as Root on ULTRIX

Before you can perform any UNIX* administration task, you must log in to the UNIX host using the administration account (root). The following procedure assumes that you have access to the UNIX host's system console and the root password before you log in to the host.

1. **Log in to the UNIX host as root by entering the following command:**

```
root <Enter>
```

The host prompts you for the root account's password.

2. **Type the password for the root account and press <Enter>.**

The host logs you in to the system as root and displays the command prompt.

Identifying Your NetWare Server for ULTRIX

The ULTRIX* host needs to know about other computers with which it communicates. Using the following procedure, edit the `etc/hosts` file to inform the ULTRIX host of new computers.

The hosts file contains two information fields:

- ◆ The IP address field, which contains the hosts's IP address formatted as a series of four integers separated by periods.
- ◆ The host name field, which contains the host's official name.

The following example shows several entries from a hosts file:

```
192.53.4.1 tulip
192.53.3.6 chaos
192.53.5.12 newyork ny nyc
```

1. **Use an editor to open the ULTRIX hosts file.**
2. **Create a new entry for the NetWare® server by typing the IP address, a space, and the server's hostname.**
3. **Save the edited hosts file and exit the editor.**

Finding Information About a User on ULTRIX

For each NetWare® user accessing NFS files through the NetWare server, you need to know both the user's user identification number (UID) and the group identification number (GID) of the user's primary login group.

This information is stored in the `passwd` file in the `/etc` directory. You can transfer the `passwd` file to the NetWare server using the UNICON utility's FTP function (see "Copying a File from a Remote Host" on page 240) or manually obtain the information for each user as described in the following section.

Finding User Information with an Account Name

Use the `grep` command to display a user's information, as shown in the following command:

```
grep username /etc/passwd <Enter>
```

Replace *username* with the user's ULTRIX account name. The following example shows the syntax for finding information about a user named *joeuser*:

```
grep joeuser /etc/passwd <Enter>
```

```
joeuser:qzogGcQdTB5zk:1848:720:Joseph User:/home/  
joeuser:/bin/csh
```

User information is displayed in seven fields. Each field is separated by a colon (:). The fields contain the following information:

- ◆ The first field contains the user's account name.
- ◆ The second field contains the user's password in an encrypted format.
- ◆ The third field contains the user's UID.
- ◆ The fourth field contains the user's primary GID.
- ◆ The fifth field contains the user's full name.
- ◆ The sixth field contains the user's home directory.
- ◆ The seventh field contains the path and name of the UNIX shell that the system runs when the user logs in to the host.

Finding User Information with a User's Full Name

If you do not know a user's account name, you may be able to use the `grep` command and the user's full name to find the user information. The following command is an example of how you could find the entry for the `joeuser` account using the name "Joe User":

```
grep Joe\ User /etc/passwd <Enter>
```

Note that the space between "Joe" and "User" is preceded by a backward slash. The backward slash tells the `grep` command that the space belongs to the first and second words.

The output from this example would be identical to the output from the previous example.

Compiling a List of User Names with UIDs and Primary GIDs

If your ULTRIX host has a large `passwd` file, you may want to create a file that contains a listing of every user and the user's corresponding UID and GID. You can create this list using the `awk` command.

The following example creates a file that contains a three-column list of user names, UIDs, and GIDs. The list is stored in the host's `/tmp` directory.

```
awk '{FS=":";print $1,$3,$4}' /etc/passwd /tmp/  
userinfo <Enter>
```

The file that results from the example contains a listing that looks like the following:

```
root 0 1  
nobody 65534 65534  
daemon 1 1  
bin 3 3  
joeuser 1848 720
```

Creating a User Account and Setting a Password on ULTRIX

You can create an account for a new user by editing the `passwd` file located in the `/etc` directory.

Creating a User Account

User information is displayed in seven fields. Each field is separated by a colon (:). The fields contain the following information:

- ◆ The first field contains the user's account name.
- ◆ The second field contains the user's password in an encrypted format.
- ◆ The third field contains the user's UID.
- ◆ The fourth field contains the user's primary GID.
- ◆ The fifth field contains the user's full name.
- ◆ The sixth field contains the user's home directory.
- ◆ The seventh field contains the path and name of the UNIX shell that the system runs when the user logs in to the host.

Each user must have a unique UID. To obtain a list of the current users sorted by UID number in ascending order, type

```
sort -t: +2 -3 -n /etc/passwd | more
```

The syntax for the entry is as follows:

```
login_name:*:UID:GID:full_name:home directory:login shell
```

The following example shows an entry from a `passwd` file:

```
joeuser:qzogGcQdTB5zk:1848:720:Joseph User:/home/joeuser:/bin/csh
```

1. Use an editor to open the `passwd` file.

2. **Create an entry for the new user as shown in the previous example.**
3. **Save the edited passwd file and exit the editor.**

After you create a user, add the user to the appropriate group(s). For instructions on adding a user to a group, see “Adding a Member to a Group” on page 393.

Setting a Password for the New Account on ULTRIX

After you add the user entry to the passwd file, the user’s account entry is created, the home directory is created, and some necessary files are placed in the home directory.

The user entry in the /etc/passwd directory does not include a password. After you add the user account, run the passwd command and set a default password for the new account. The format for setting a password for Joe User’s account is shown in the following:

```
passwd joeuser
```

The system prompts you to enter the new password and reenter it to verify that you typed it correctly. The /etc/passwd file is updated to include the encrypted version of the password.

Finding Information About Groups on ULTRIX

Each group defined on the ULTRIX host has a listing in a file named group. This file is stored in the /etc directory. You can transfer the group file to the NetWare server using the UNICON utility’s FTP function (see “Copying a File from a Remote Host” on page 240) or obtain the information for each group manually as described in the following paragraphs.

Compile a list of group names and group identification numbers using the awk command.

The following example creates a file that contains a two-column list of group names and GIDs. The list is stored in the host's /tmp directory.

```
awk '{FS=":";print $1,$3}' /etc/group /tmp/  
groupinfo <Enter>
```

The file that results from the example contains a listing that looks like the following:

```
wheel 0  
daemon 1  
operator 2
```

Creating an ULTRIX Group

The information about ULTRIX groups is stored in the /etc/group file. To create a group, add an entry for the group to this file.

Setting Up the /etc/group File

To create a new group, use a text editor to open the /etc/group file and insert information about the group.

The group file consists of four fields:

- ◆ The group name field
- ◆ The group password field
- ◆ GID
- ◆ The list of users who are members of the group

Each field is separated by a colon (:). Group member names are separated by commas (,).

Following is a sample entry from the group file:

```
wheel*:0:daemon,root
```

Each group must have a unique GID. The asterisk in the password field means that members cannot use the `newgrp` command to temporarily switch their primary group association to the group.

1. **Use an editor to open the group file.**
2. **Create an entry for the new group as shown in the previous example.**
3. **Save the edited group file and exit the editor.**

Adding a Member to a Group

Add a user to a group by using a text editor to open the `etc/group` file and insert information about the new member.

The fourth field in the group file contains names of the group members. Individual names are separated by commas (.).

The following is an example entry from the group file. The group members are `arnolds` and `rdoover`.

```
newgroup*:902:arnolds,rdoover
```

1. **Use an editor to open the group file.**
2. **Add the new member at the end of the entry for the appropriate group.**
3. **Save the edited group file and exit the editor.**

Exporting a File System on ULTRIX

Grant the NetWare server authorization to access a specific file system by adding the appropriate entry in the NetWare server's `/etc/exports` file.

Note: The ULTRIX system must be running the `portmap`, `nfsd`, and `mountd` daemons to successfully export a file system.

Setting Up the `/etc/exports` File

Before a NetWare client can access a file system on a NFS server, the file system's mount path and those clients allowed access to the files must be entered in the `/etc/exports` file, which resides on the NetWare server. This entry has the following syntax:

```
filesystem [ option1 [ option2 ] ... ]
```

For *filesystem*, specify the path using UNIX conventions (pathnames are case-sensitive). Here is an example of a path in UNIX:

```
/nfs1/users
```

The options can be any combination of the following. Use a comma to separate options.

```
-access=client1[:client2 [:client3]]...
```

This option identifies clients who are allowed access to the file system. If this option is not specified, any client can access the file system. Replace *client* with the NetWare server's hostname. If more than one client is listed, separate each name with a colon.

```
-anon
```

This option specifies if anonymous (not known to the system) users can access the file system. If `anon` is not specified, the default is Yes. If `anon` is specified, the default is No. (NFS assigns anonymous user an identification of UID -2 and GID-2)

-ro

This option specifies that the directory be exported in read-only format. If this option is not specified, the directory is exported as read-write.

-root=*hostname1[:hostname2 [:hostname3]...]*

This option specifies which root users can access the file system. If this option is not specified, root UID 0 receives the rights of the NetWare class NOBODY, granting the privileges of the ULTRIX user class "others" to root.

Replace *hostname* with the name of the NetWare client. If more than one client is listed, separate each name with a colon.

-rw:*hostname*

This option specifies that the directory be exported to the specified host for reading and writing. This option overrides the **-ro** option. If no *hostname* is given, the directory is exported read-write to all.

Examples

Here are two examples of an entry in the exports file:

```
# "Exported Path", "Trusted Systems"  
/nfs1/project2 -access=sunrise:ca:na,  
-root=sunrise, -ro, -rw:sunrise, -anon
```

In the preceding example, the NetWare server's directory file system to be accessed is `/nfs1/project2`. The clients accessing the file system are "sunrise," "ca," and "na." The superuser on sunrise also has root privileges in the `/nfs1/project2` file system. The clients "ca" and "na" have "read only" access to the file system, but "sunrise" has "read and write" permission. Anonymous users (classified as NOBODY or NOGROUP) are not allowed to access the file system.

```
/nfs1/project3 -ro
```

In the preceding example, all clients can access the file system `/nfs1/project3` with “read only” permission, and all NetWare users with a UID of 0 are granted privileges equivalent to the NetWare user NOBODY.

Mounting a File System from an ULTRIX Machine

Grant the required authorization to mount a remote file system by entering the appropriate entry in the NFS server’s `/etc/fstab` file. An entry in the `fstab` file causes the server to mount the remote file system automatically each time the server starts. If you want to mount a file system immediately, use the `mount` command. Refer to the following sections for detailed procedures.

Note: The ULTRIX system must be running the `portmap`, `nfsd`, and `mountd` daemons to successfully mount a file system.

Setting Up the `/etc/fstab` File

Use the `etc/fstab` file to specify the remote file systems you want mounted. Create `fstab` entries using the following format:

```
remote_filesystem@remote host:mount_point[option1: [option2: ] ... ]
```

For example, if you want the file system `/vol1/docs` to automatically mount from NetWare server `sjf-argos` to the local mount point `/newdocs/documents`, create the following entry:

```
/vol1/docs@sjf-argos:docs/documents
```

For a detailed description of the options, refer to the ULTRIX documentation on the `fstab` file.

Using the `mount` Command

If you want to mount a file system immediately, use the `mount` command as follows:

```
mount -t nfs server_name:/remote_filesystem /mount_point
```

For example, if you want to mount the remote file system `/vol1/docs` from a NetWare server named `sjf-argos` onto the local mount point `/newdocs/documents`, type

```
mount -t nfs sjf-argos:/vol1/docs /newdocs/documents
```

For a detailed description of the options, refer to the ULTRIX documentation on the `mount` command.

Printing on ULTRIX

The procedures in this section describe what to do at the UNIX* host to use NetWare® bidirectional printing.

This section assumes you are running ULTRIX* v4.2. Earlier versions may not contain the functionality as described in the following:

Prerequisites

Before you proceed, verify that the `lpd` daemon is running on the UNIX host by issuing the following command:

```
ps aux | grep lpd
```

If the `lpd` daemon is running, you should see output similar to:

```
root    8389  0.0  0.0   52   0 ?   IW   02:37   0:01
/usr/lib/lpd
```

If the `lpd` daemon is not running, start the daemon by logging in to the UNIX host as `root` and entering the following command:

```
/usr/lib/lpd
```

Verify that the daemon is running by using the `ps` command previously described.

To automatically start the lpd daemon when the system starts, make sure that an entry like the following is in the /etc/rc file:

```
if [ -f /usr/lib/lpd ]; then
    rm -f /dev/printer /var/spool/lpd.lock
    /usr/lib/lpd;          echo -n ' printer'
fi
```

Printcap File Format

Many operating systems (including SunOS) use a printcap (printer capability) file to configure local and remote printing. The file has an entry for each printer in the following format (for information on additional options, enter “man printcap” at the UNIX prompt):

```
printer_name1 | printer_name2 | printer_nameN | \  
: printer_description : lp=print_device_name : \  
: rm=netware_server_name : \  
: rp=netware_print_queue_name : \  
: sd= /user/spool/spool_directory : mx#file_size \  
: rs :
```

Where

printer_name1, *printer_name2*, ... *printer_nameN*—names used by UNIX users to refer to this printer.

printer_description—a text string describing the printer in more detail (for example: “Laser printer on first floor”).

print_device_name—name of a print device on the local UNIX machine (for example, “lp=/dev/lp”). When printing to a printer on a remote machine, *print_device_name* should be the null character (for example, “lp=”).

netware_server_name—name of the NetWare server accepting print jobs. This should be the name listed in the /etc/hosts file on the UNIX host for the NetWare server.

netware_print_queue_name—name of the remote NetWare print queue. This entry is not case-sensitive.

spool_directory—name of the spool directory on the local UNIX machine. This is where print jobs are temporarily stored before they are printed. You must manually create this directory (for example: as root, type at the UNIX prompt “`mkdir /usr/spool/spool_directory`”). It is customary to give *spool_directory* the same value as *netware_print_queue_name*.

#file_size—the maximum size (measured in blocks) of a file that can be spooled to the printer. If *file_size* = 0, files of unlimited size can be spooled to the printer.

rs—remote users can use this printer only if they have a local account on the system. Omitting the *rs* parameter enables any remote user on a “trusted host” to use this printer.

UNIX-to-NetWare Printing

Remote computers supporting LPR protocol can print to NetWare printers by using the UNIX-to-NetWare print service. To configure your UNIX host so users can spool print jobs to the print queue on the NetWare server, perform the following procedure:

1. **Log in to your UNIX host as root.**
2. **Use a text editor to add the printer entry to the `/etc/printcap` file.**
3. **Create a spool directory by entering the following command at the UNIX prompt:**

```
mkdir /usr/spool/queue
```

where *queue* is the exported queue you create on the NetWare server for access by remote users.

4. **Try printing to the NetWare printer by entering the following command:**

```
lpr -dprinter filename
```

5. **Examine the NetWare print queue on the NetWare server by entering the following command:**

```
lpq printer
```

NetWare-to-UNIX Printing

Use this product to configure the UNIX host so that NetWare users can spool print jobs to the UNIX printer:

1. **Log in to your Sun host as root.**
2. **Use a text editor to add the printer entry to the `/etc/printcap` file.**
3. **Create a spool directory by entering the following command at the UNIX prompt:**

```
mkdir /usr/spool/queue
```

where *queue* is the exported queue you create on the NetWare server for access by remote users.

4. **Use a text editor to add the name of the NetWare server to the `/etc/hosts.lpd` file.**

This entry allows the NetWare server to spool print jobs to your UNIX host.

5. **Log in to the NetWare server and try printing to the UNIX printer by entering the following command:**

```
NPRINT filename /q=queue
```

UnixWare Administration Procedures

Use this section to configure your UnixWare* system to function with NetWare®.

Complete the following procedures as necessary:

- ◆ “Determining if NIS is in Use on UnixWare” on page 476
- ◆ “Obtaining User, Group, and Host Information from NIS on UnixWare” on page 476
- ◆ “Determining if DNS is In Use on UnixWare” on page 477
- ◆ “Logging in as Root on UnixWare” on page 477
- ◆ “Accessing the UnixWare Administration Tools” on page 478
- ◆ “Identifying Your NetWare Server for UnixWare” on page 478
- ◆ “Finding Information About a User on UnixWare” on page 479
- ◆ “Creating a User Account and Setting a Password on UnixWare” on page 482
- ◆ “Finding Information About Groups on UnixWare” on page 483
- ◆ “Creating a UnixWare Group” on page 485
- ◆ “Exporting a File System on UnixWare” on page 487
- ◆ “Mounting a File System from a UnixWare Machine” on page 488
- ◆ “Printing on UnixWare” on page 490

Determining if NIS is in Use on UnixWare

Use the terminal tool from within the Accessories window to access the command line and enter the following command to determine if your UnixWare* system is running NIS:

```
ypwhich <Enter>
```

If the command returns a domain name, the system is using NIS to store user and group information. If the command returns a message similar to the following:

```
ypwhich: host not running ypbind
```

the system is using a different database to store user and group information.

Obtaining User, Group, and Host Information from NIS on UnixWare

If your system is using NIS and you want your NetWare® server to use (point to) the NIS database on the UnixWare* host, enter the NIS domain name and server address in the appropriate fields of the Server Profile form. For more information on using a non-NetWare NIS server, see “Using a Non-NetWare Server as the NIS Master” on page 222.

If your system is using NIS and you want to transfer the user, group, and host information from the UnixWare machine to the NetWare server, you must first create files from the NIS database. The following commands create these files:

```
ypcat hosts > /tmp/hosts <Enter>  
ypcat passwd > /tmp/passwd <Enter>  
ypcat group > /tmp/group <Enter>
```

You can now transfer the files to the NetWare server using the UNICON utility’s FTP function (see “Copying a File from a Remote Host” on page 240).

When the files are larger than 64 KB, you cannot use the remove file function available through the UNICON utility to edit unwanted entries. If any of your files are too large, use a DOS editor or remove the unwanted entries before you transfer the file from the UnixWare system to the NetWare server.

Determining if DNS is In Use on UnixWare

To determine if your UnixWare* system is using DNS to store host information, search for the `resolv.conf` file located in the `/etc` directory. If this file exists, your system is using DNS. Otherwise, your system is using a different method to store host information.

If your system is using DNS and you want your NetWare® server to use (point to) the DNS host database on the UnixWare host, enter the domain name and server address contained in the `resolv.conf` file in the appropriate fields of the Server Profile form.

Logging in as Root on UnixWare

Before you can perform any UnixWare* administration task, you must log in to the UnixWare host using the administration account (root). The following procedure assumes you have access to the UnixWare host's system console and the root password before you log in to the host.

1. **Log in to the UnixWare host as root by entering the following command:**

```
root <Enter>
```

The host prompts you for the root account's password.

2. **Type the password for the root account and press <Enter>.**

The host logs you in to the system as root and displays the command prompt.

Accessing the UnixWare Administration Tools

Use the following procedure to access the UnixWare* administration icons.

1. **From the desktop, double-click the System Setup icon.**

The utility displays the UnixWare administration icons in the System Setup window.

2. **Complete procedure and exit.**

Identifying Your NetWare Server for UnixWare

The UnixWare host needs to know about other computers with which it communicates. Use the Internet Setup Application to inform the UnixWare host of new computers.

1. **Start the Internet Setup application by double-clicking the Internet Setup icon.**

The application displays the Internet Setup window.

2. **From the System menu, make the following selection:**

⇨ **New**

The application displays the Remote System Properties form.

3. **Type the NetWare server name into the System Name field and press <Tab>.**

The application moves the cursor to the Show Full Address field.

4. **Click on the Show Full Address box and press <Tab>.**

The application moves the cursor to the Network Address field.

5. **Type the NetWare server's IP address and click on Apply.**

The application adds the NetWare server to the list of remote systems.

6. **From the Action menu, make the following selection:**

↳ **Save Systems List**

The application saves the new host information.

7. **Click on the X located at the upper right corner of the window and select Exit from the menu to close the window.**

The application displays the System Setup window.

Finding Information About a User on UnixWare

For each NetWare® user accessing NFS files through the NetWare server, you need to know both the user's user identification number (UID) and the group identification number (GID) of the user's primary login group.

This information is stored in the `/etc/passwd` file. You can transfer the file to the NetWare server using the UNICON utility's FTP function (see "Copying a File from a Remote Host" on page 240) or manually obtain the information for each user as described in the following section.

Finding User Information Using the Administration Tool

Use the User Setup application to display information about a user.

1. **Start the User Setup application by double-clicking on the User Setup icon.**

The application displays the User Setup window, which displays an icon for each user.

2. **Click on a specific user icon and make the following selection from the Account menu:**

↳ **Properties**

The application displays the User Account Properties window.

3. Click on the Extended Options box.

The application displays the following information:

- ◆ Login ID (user name)
- ◆ Comment (user's full name)
- ◆ User's default group
- ◆ UID
- ◆ User's home directory
- ◆ User's login shell
- ◆ Other groups of which the user is a member

4. Click on the X located at the upper right corner of the window and select Exit from the menu to close the window.

The application displays the User Setup window.

Finding User Information with a UNIX Account Name

Use the `grep` command to display information about a user:

```
grep username /etc/passwd <Enter>
```

Replace *username* with the user's UNIX account name. The following example illustrates how to find information about a user named *joeuser*:

```
grep joeuser /etc/passwd <Enter>
```

```
joeuser:qzogGcQdTb5zk:1848:720:Joseph User: /home/  
joeuser: /bin/csh
```

User information is displayed in seven fields. Each field is separated by a colon (:). The fields contain the following information:

- ◆ The first field contains the user's account name.
- ◆ The second field contains the user's password in an encrypted format.

- ◆ The third field contains the user's UID.
- ◆ The fourth field contains the user's primary GID.
- ◆ The fifth field contains the user's full name.
- ◆ The sixth field contains the user's home directory.
- ◆ The seventh field contains the path and name of the UNIX shell that the system runs when the user logs in to the host.

Finding User Information with a User's Full Name

If you do not know a user's account name, use the `grep` command and the user's full name to find information. The following command illustrates how to find the entry for the `joeuser` account using the name `Joe User`:

```
grep 'Joe User' /etc/passwd <Enter>
```

This command displays the same information as the previous example.

Compiling a List of User Names with UIDs and Primary GIDs on UnixWare

If your UNIX host has a large `passwd` file, you may want to create a file that lists every user and the user's corresponding UID and GID. Create this list using the `awk` command.

The following example creates a file containing a three-column list of user names, UIDs, and GIDs. The list is stored in the host's `/tmp` directory.

```
awk '{FS=":";print $1,$3,$4}' /etc/passwd /tmp/  
userinfo <Enter>
```

The file created by the example contains a list that looks like this:

```
root 0 1
nobody 65534 65534
daemon 1 1
bin 3 3
joeuser 1848 720
```

Creating a User Account and Setting a Password on UnixWare

Use the User Setup application to create an account for a new user.

Every user must have a unique UID.

1. **Start the User Setup application by double-clicking on the User Setup icon.**

The application displays the User Setup window, which displays an icon for each user.

2. **From the Account menu, make the following selection:**

➤ **New**

The application displays a form for adding a new user.

3. **Fill in the Login ID (name) and Comment (usually full name) fields.**

The form reflects the modifications as you enter each new value.

4. **Click on the Extra Options button.**

The utility displays additional fields.

5. **Fill in the Default Group field.**

You do not need to fill in any other information to create a user. However, you can change the default settings for UID, Home Directory, Login Shell, or Groups.

- 6. Click on Add to create the new user and save the information.**

The application displays a confirmation box prompting you to confirm that you want to create the new user.

- 7. Click on Yes.**

The application prompts you for a password.

- 8. Type the password for the new user and press <Enter>.**

The application prompts you to reenter the password.

- 9. Type the password for the new user again and press <Enter>.**

The application displays the User Setup window. An icon representing the new user account is added to the User Setup window.

- 10. Click on the X located at the upper right corner of the window and select Exit from the menu to close the window.**

The application displays the System Setup window.

Finding Information About Groups on UnixWare

Each group defined on the UnixWare host is listed in the `/etc/group` file. You can transfer the file to the NetWare server using the UNICON utility's FTP function (see "Copying a File from a Remote Host" on page 240) or obtain the information for each group manually as described in the following section.

Finding Group Information with a UnixWare Group Name

Use the User Setup application to display group information.

- 1. Start the User Setup application by double-clicking on the User Setup icon.**

The application displays the User Setup window, which displays an icon for each user.

2. **From the View menu, make the following selection:**

↳ **Groups**

The application displays an icon for each group.

3. **Click on a specific group icon and make the following selection from the Group menu:**

↳ **Properties**

The application displays the following information in the Group Properties window:

- ◆ Group name
- ◆ GID

4. **Click on the X located at the upper right corner of the window and select Exit from the menu to close the window.**

The application returns to the Group Setup window.

Compiling a List of Groups and GIDs

Use the awk command to compile a list of group names and group identification numbers.

The following example creates a file that contains a two-column list of group names and GIDs. The list is stored in the host's /tmp directory.

```
awk '{FS=":";print $1,$3}' /etc/group > /tmp/  
groupinfo <Enter>
```

The file created by this example contains a list that looks like this:

```
wheel 0  
daemon 1
```

Creating a UnixWare Group

Information about UnixWare* groups is stored in the `/etc/group` file. Use the User Setup application to create a new group.

To create a group, you need the following information:

- ◆ Group name
- ◆ GID

Note: Although the form contains other fields, only those in the preceding list are necessary to create a new group.

Creating a Group

Use the following procedure to create a group.

1. **Start the User Setup application by double-clicking on the User Setup icon.**

The application displays the User Setup window, which displays an icon for each user.

2. **From the View menu, make the following selection:**

☞ **Groups**

The application displays an icon for each group.

3. **From the Group menu, make the following selection:**

☞ **New**

The application displays a form for adding a new group.

4. **Fill in the Group Name field.**

You do not need to fill in any other information to create a group. However, if you do not want to use the next available GID to identify this group, you can enter a GID into the GID field.

5. **Click Apply to create the new group and save the information.**

The application displays a confirmation box prompting you to confirm that you want to create the new group.

6. Click on Yes.

An icon representing the new group is added to the Group Setup window.

7. Click on the X located at the upper right corner of the window and select Exit from the menu to close the window.

The application returns to the Group Setup window.

Adding a Member to a Group

Use the following procedure to add a member to a group.

1. Start the User Setup application by double-clicking on the User Setup icon.

The application displays the User Setup window, which displays an icon for each user.

2. Click the icon for the user whom you want to add to a group and make the following selection from the Account menu:

➤ **Properties**

The application displays the User Account Properties window.

3. Click on the Extended Options box.

The application displays the following information:

- ◆ Login ID (user name)
- ◆ Comment (user's full name)
- ◆ User's default group
- ◆ UID
- ◆ User's home directory
- ◆ User's login shell
- ◆ Other groups of which the user is a member

4. **Click on the group to which you want to add the user and click on Apply.**

The application prompts you to confirm modifying the user information.

5. **Click on Yes to save the changes.**

The application saves the changes and returns to the User Setup window.

6. **Click on the X located at the upper right-hand corner of the window and select Exit from the menu to close the window.**

The application displays the System Setup window.

Exporting a File System on UnixWare

Use the File Sharing application to grant the NetWare® server the required authorization to access a specific file system.

1. **Start the File Sharing application by double-clicking on the File Sharing icon.**

The application displays the File Sharing window.

2. **From the View menu, make the following selection:**

↳ **Local**

The application displays the local share-items.

3. **From the Share-Item menu, make the following selection:**

↳ **New**

The application displays the Add New Share-Item window.

4. **Click on the Find button.**

The application displays a list of folders and files on the system.

5. **Select the directory you want to export and click on Apply.**

The application displays the Add New Share-Item window.

6. **Select the Yes box in the Advertise When NFS Starts field to export the directory each time you start NFS.**

7. **Select either Read-Only or Read-Write.**

The application displays the Exported Directories screen. By default, all directories are exported with Read/Write access. You can also add any command line options from the extended options field.

8. **Click on Add.**

The application saves the information and displays the exported directory as an icon in the Local Share-Item window.

9. **Click on the X located at the upper right corner of the window and select Exit from the menu to close the window.**

The application displays the File Sharing window.

Mounting a File System from a UnixWare Machine

You mount an exported NetWare® directory by adding the appropriate entry using the File Sharing application.

1. **Start the File Sharing application by double-clicking on the File Sharing icon.**

The application displays the File Sharing window.

2. **From the menu, make the following selection:**

⇨ **Share Item**

The application displays the Add New Share-Item window.

3. **From the Share Item menu, make the following selection:**

⇨ **New**

The application displays the Add New Share-Item form.

4. **Click on the Search button.**

The application displays a list of remote hosts.

- 5. Select the remote host that contains the file system that you want to access.**

The application returns to the Add New Share-Item window and displays a list of exported directories.

- 6. Select the directory to mount from the list.**

The application returns to the Add New Share-Item window and moves to the Local Folder to Connect it to field.

- 7. Click on the Find Folder button.**

The application displays a list of folders and files on the system.

- 8. Select the directory that you want to act as a mount point.**

The application returns to the Add New Share-Item window.

- 9. Select either Read-Only or Read and Write.**

By default all directories are mounted with Read and Write access. You can also add any command line option from the extended options field.

- 10. Select the Yes box in the Connect When NFS Starts box to mount the directory each time you start NFS.**

- 11. Click on Add.**

The application saves the information and displays the mounted directory as an icon in the Local Share-Item window.

- 12. Click on the X located at the top right corner of the window and select Exit from the menu to close the window.**

The application returns to File Sharing window.

Printing on UnixWare

The procedures in this section describe what to do at the UNIX* host to use NetWare® bidirectional printing.

UNIX-to-NetWare Printing

Remote computers supporting LPR protocol can print to NetWare printers using the UNIX-to-NetWare print service. In addition to setting up this print service as described in “Managing Print Services” on page 172, you need to configure your host machine as follows.

For printing purposes, the UnixWare system should have at least the update level Update3. To check this, type the `pkginfo` command at the shell prompt. You should see the following:

```
Update  Update3           UnixWare Update Package
```

Use this procedure to configure the UnixWare system for UNIX-to-NetWare Printing:

1. **Add the host name and IP address of the NetWare server to the `/etc/hosts` file on the UnixWare system.**
2. **Start the UnixWare desktop as root. (Refer to the UnixWare documentation for information about starting the desktop for troubleshooting purposes.)**
3. **Double-click on the `System_Setup` icon.**
4. **Double-click on the `Printer_Setup` icon.**
5. **Click on the `ACTIONS` button and select `SET REMOTE ACCESS`.**

This identifies the type of remote system to which UnixWare should print.

6. **Select the NetWare host name from the list and double-click until the line shows the following:**

```
SYSTEM NAMEO/S  TYPEREMOTE  ACCESS  
NetWare_host  BSD      Enabled.
```

7. **Click on Save to exit.**
8. **Click on PRINTER and select NEW.**
9. **Choose Remote Unix System. The following form will be displayed:**

```
Printer Name:  
Type:  
Remote System Name:  
Remote Printer Name:  
Remote Operating System is:
```

10. **Fill out the form with the following information:**
 - ◆ Printer Name—name of the printer to refer to in UnixWare.
 - ◆ Type—supported printer. Select from list. Select DOS printer if no other is applicable.
 - ◆ Remote System Name—name used in the /etc/host file for the NetWare server.
 - ◆ Remote Printer Name—name of the NetWare print queue.
 - ◆ Remote Operating System—BSD.
11. **Click on Add to save the information.**

NetWare-to-UNIX Printing

This section describes how to configure a UnixWare system to accept a print job from a NetWare client.

For printing purposes, the UnixWare* system should have at least the update level Update3. To check this, type the `pkginfo` command at the shell prompt. You should see the following:

```
Update   Update3           UnixWare Update Package
```

This section assumes that a working printer is already set up on the UnixWare system. If a printer is not set up, refer to the UnixWare documentation for assistance.

Use this procedure to configure the UnixWare system for NetWare-to-UNIX printing.

1. **Add the host name and IP address of the NetWare server to the /etc/hosts file on the UnixWare system.**
2. **Start the UnixWare desktop as root. (Refer to the UnixWare documentation for information about starting the desktop for troubleshooting purposes.)**
3. **Double-click on the System_Setup icon.**
4. **Double-click on the Printer_Setup icon.**
5. **Click on the ACTIONS button and select SET REMOTE ACCESS.**

This identifies the type of remote system to which UnixWare should print.

6. **Select the NetWare host name from the list and double-click until the line shows the following:**

```
SYSTEM NAMEO/S TYPEREMOTE ACCESS  
NetWare_host BSD Enabled.
```

7. **Click on Save to exit.**
8. **Choose the local printer to be used for printing and click on the PRINTER button.**
9. **Choose the PROPERTIES----->BASIC option.**
A prompt asks if you want remote access.
10. **Allow remote access by answering YES.**

Troubleshooting

If problems occur when trying to send jobs from NetWare to UnixWare, use the `tabs` option in either the `CAPTURE` command or the `NPRINT` command to force the job to be sent in text format instead of as a byte stream.

For other troubleshooting purposes, examine the following lp log files for clues:

```
/var/lp/logs/lpNet  
/var/lp/logs/lpsched
```

appendix **B** Parameters

Parameters that can be configured by the user as required are described in this section. The default, maximum and minimum value allowed for each of these parameters is given here.

LPR_GWY

Parameter Name	Default Value	Range of Values	Description
SKIP_NETDB_MAPPING	OFF		Usage: To be used when there is a problem with NetDB logging into NDS™ which prevents LPR_GWY module from loading.
LPR_GWY_POLLING_TIME	2 secs	2- 10 secs	Explanation: Controls the frequency of polling remote UNIX* printers by LPR_GWY and updates their status and the status of the jobs queued. Usage: To be used only when LPR_GWY is operating in DIRECT Mode (in other words, when the LPR_GWY_MODE parameter is not configured or set to OFF). Note: Because this parameter affects the performance of the LPR_GWY module, it should be used with caution. Setting it to a higher value decreases the polling frequency and increases the time it takes for LPR_GWY to detect a change in the printer status.

Parameter Name	Default Value	Range of Values	Description
LPR_GWY_ DIRECT_MODE	ON	ON/ OFF	<p>Explanation: LPR_GWY supports two modes of operation: Normal Mode and the Direct Mode.</p> <p>In the Normal Mode, LPR_GWY operates synchronously spooling one job at a time to the printer. It monitors the status of the spooled job and, when the job is complete, spools another job onto the printer.</p> <p>In the Direct Mode, LPR_GWY operates asynchronously and allows multiple jobs to be spooled to a remote printer without waiting for the completion of the earlier print jobs on the remote printer. So, spooling of jobs in the Direct Mode is faster.</p> <p>By default, when the LPR_GWY_DIRECT_MODE parameter is not configured or set to ON, it operates in the Direct Mode. If this is set to OFF, it operates in the Normal Mode.</p>
LPR_GWY_WRT_ CHK_TIME	15 secs	10 - 30 secs	<p>Explanation: Controls the time for which LPR_GWY waits on a network socket associated with a TCP connection to the remote UNIX printer.</p> <p>Usage: Prior to a Read or Write operation on a socket, LPR_GWY polls the socket for its readiness for the Read/Write operation. This parameter may be used to increase or decrease this poll time depending on the response time from the remote printer.</p> <p>Note: As this parameter affects the performance of the LPR_GWY module, it should be used with caution.</p>

Parameter Name	Default Value	Range of Values	Description
LPR_GWY_MAX_PRT_TIME	300 secs	30 secs - 2 hrs	<p>Explanation: This parameter controls a timeout value, in other words, the maximum amount of time that LPR_GWY should wait for a remote UNIX printer to respond to the read or write operation.</p> <p>Usage: This parameter is useful when you are printing onto Network Direct printers. In such cases, when the paper runs out, further data from LPR_GWY is not accepted till additional paper is inserted. When this happens, LPR_GWY drops the connection after waiting for a timeout value controlled by this parameter. When the paper is inserted, the corresponding job is spooled again by LPR_GWY.</p> <p>Note: If this parameter is set to a higher value, LPR_GWY will wait for this period for paper to be restored on the remote printer.</p>
LPR_GWY_CHK_PRT_TIME	120 secs	30 - 300 secs	<p>Explanation: Determines the time for which LPR_GWY should wait for a response from the remote UNIX printer and controls the secondary printer status message displayed on the Pserver screen.</p> <p>Until the time specified elapses, LPR_GWY displays a "Printer Busy" secondary status message. If response is not received within this time, LPR_GWY waits for the period configured in the LPR_GWY_MAX_PRT_TIME parameter. After this period has elapsed, it displays a "Printer Needs Attention" secondary status message on the Pserver screen.</p>

Parameter Name	Default Value	Range of Values	Description
LPR_GWY_IR_TIME	10 secs	2 - 10 secs	<p>Explanation: Controls the frequency at which LPR_GWY polls the remote UNIX printers that need intervention, for example when messages such as Printer Down, Out-of-Paper, etc. are displayed. It determines the time it takes for LPR_GWY to detect whether a specific remote printer is Ready and Online.</p> <p>Usage: Setting this parameter to a lower value allows LPR_GWY to detect changes in Printer Statuses faster but increases network traffic and affects the performance of LPR_GWY.</p> <p>Note: As this parameter affects the performance of the LPR_GWY module, it should be used with caution.</p>
HIGH_WATER_MARK	900	100-990	<p>Explanation: Specifies the threshold value for the number of outstanding jobs that are spooled to the remote printer.</p> <p>When the number of jobs in the remote printer queue exceeds this threshold, LPR_GWY polls the remote printer for its queue status after spooling every job to the printer. This polling is required to determine the free sequence numbers available with LPR_GWY for a specific remote printer. LPR_GWY uses a free sequence number (between 0 and 999) to identify a specific job.</p>

Parameter Name	Default Value	Range of Values	Description
SPOOL_CFILE_FIRST	ON	ON/ OFF	Explanation: Controls the order in which the Data and the Control files are spooled onto a remote printer. By default, the Control file is spooled first, followed by the Data file. Set this parameter to OFF if the Data file is to be spooled first.
JOB_FAILURE_OPTION	ABORT	ABORT, HOLD & RETRY	Explanation: Controls what LPR_GWY does with a specific job which has failed to get spooled on the remote printer. Usage: By default, LPR_GWY attempts to spool a job up to three times on a remote printer. If the job does not get spooled even after three attempts, you can use this parameter either to cancel (ABORT), put on hold (HOLD) or continue (RETRY) with the job.
IDC_OVERRIDE	OFF	ON/ OFF	Explanation: The Queue Status command determines the sequence number of jobs in the remote printer queue and identifies the free sequence numbers available for spooling jobs to the remote printer. LPR_GWY cannot commence printing jobs to a remote printer until it gets a successful response to the LPQ (Queue Status) command. Some printers/print servers do not support the LPQ command. LPR_GWY can be made to work with such printers if this parameter is set to ON.

FTP Server

Parameter Name	Default Value	Range of Values	Description
GUESTDEF	SYS		<p>Explanation: This is the anonymous user's home directory.</p> <p>Usage: When a user logs in using the anonymous account, GUEST restrictions are imposed. The user can see only the specified home directory but can access other subdirectories. The parent directory for this home directory cannot be accessed. Depending on other permissions, the user can create and access other directories.</p> <p>The default directory is "SYS," which indicates an anonymous directory under the SYS volume.</p>
USERDEF	SYS		<p>Explanation: This is the default home directory for other users (other than anonymous). The default directory is "SYS," which indicates SYS volume only.</p> <p>Note: Apart from this parameter, the file restrict.ftp determines whether the user is forced to stay within the current directory. By default, the user's current directory is the default home directory, but the user can change to the parent directory.</p>
NAME-SPACE	DOS		<p>Explanation: This is the default name space with which the FTP user logs in. The other option is NFS. In this case, the name space would be set to NFS whenever the user logs in. NFS name space will take effect only when the volume itself supports NFS name space.</p> <p>Setting this to NFS is the same as doing a "site NFS" on the FTP prompt immediately upon logging in.</p>

Parameter Name	Default Value	Range of Values	Description
LOG_LEVEL	1	0 - 3	<p>Explanation: When any person logs in to the FTP server, a record of the login is maintained. Using this parameter, you can specify the login details that need to be maintained.</p> <p>0 - no logging</p> <p>1 - for statistics only</p> <p>2 - for login details</p> <p>3 - for file transfer logging</p>
LOGIN_RESET	3000 mns	5 - 99999 mns	<p>Explanation: The number of minutes after which the LOG will be cleared and restarted.</p>
LOGIN_LIMIT	6	1 - 9999	<p>Explanation: The number of unsuccessful login attempts allowed before the attempts get recorded in the log files.</p>
INTRUDER_CHECK	No	Yes No	<p>Explanation: Determines whether login attempts by intruders should be tracked. This parameter enables the LOGIN_LIMIT parameter, and unsuccessful login attempts are tracked to detect intruder logins.</p>
ANONYMOUS_ACCESS	0 or No		<p>Explanation: If this parameter is set to 1, anonymous access is allowed to the FTP server. A status of 0 denies access to the FTP server (even if there is an ordinary user by the name "anonymous").</p>
MAX_TIME	400 mns	1 - 99999 mns	<p>Explanation: The maximum period for which an FTP session can be active. If the period is exceeded, the user is forcefully logged out and the connection is terminated.</p>

Parameter Name	Default Value	Range of Values	Description
IDLE_TIME	30 mns	-1- 99999 mns -1 (indicates no limit)	<p>Explanation: When an FTP request is sent to the server, FTPSERV.NLM is loaded by INETD. This remains active as long as the connection is valid. When there are no connections, after a specified period, FTPSERV.NLM is automatically unloaded.</p> <p>This period for which the FTPSERV.NLM should wait before unloading is specified by the IDLE_TIME parameter.</p> <p>Usage: Loading the FTPSERV.NLM every time a request comes in is time consuming. So, if this NLM is still loaded when a new request comes in, there will be an improvement in the response time.</p>
SESSION	9	1 - 64	<p>Explanation: The maximum number of sessions that can be simultaneously active. If a user tries to log in when all the sessions are active, access is not granted, and a message is displayed advising the user to try later.</p>
<p>The next three parameters are newly added and are optional parameters. This feature is new and these parameters were not present in earlier FTP servers. They may not be available in the other FTPSERV modules for which this feature has not been included. As these parameters are not yet administered via UNICON, default values as specified are applicable.</p>			
PASSIVE_ RANGE	NO	YES/NO	<p>Explanation: Determines whether PASSIVE RANGE checking is required. This parameter specifies whether the FTPSERV should try to open the PASSIVE ports in the specified range.</p> <p>Note: The actual ranges are specified in the next two parameters. This parameter allows the user to turn off this feature without deleting the lines specifying the next two parameters.</p>

Parameter Name	Default Value	Range of Values	Description
PASSIVE_ MIN	5000		Explanation: This is the lowest port number that the FTPSERV can open in the PASSIVE mode. Whenever a new PASSIVE port is requested, this number will be used.
PASSIVE_ MAX	65535		Explanation: The highest port number that the FTPSERV can open in the PASSIVE mode. When this value is exceeded, the value specified by the PASSIVE_MIN parameter will be used. When all ports in the specified range are used, connection will be denied.
CREATE_ NO_ TRUSTEES	0	0 1	Explanation: This parameter is used to set permissions for files created through the FTP server. If this parameter is set to 1, [RW] permissions are granted to the group. If this parameter is set to 0, [RW] permissions are granted only to the user and not the group.

NetDB

Parameter Name	Default Value	Range of Values	Description
WRITELOCAL FILES	0	0 (reset) 1 (set)	Explanation: This is the compatibility mode parameter. Set this mode if you want to search for the NetDB entries only in the local server and not on the network.
NDS_LOGIN_MSG	1	0 (reset) 1 (set)	Explanation: This parameter is used to enable or disable the printing of error messages on the screen. If this is set, the messages are printed on the screen.
NDS_CONTEXT	() blank		Explanation: This represents the default OU in the NWPARAMS file. This must be set by the user by editing the NWPARAMS file; otherwise (if it is blank) the Bindery Context and server location will be used to determine the default OU.

NIS

Parameter Name	Default Value	Range of Values	Description
DEFAULT_DOMAIN	0	0 (reset) 1 (set)	<p>Explanation: The NIS and DNS services are initialized at the time of product installation. A Domain represents an administrative area served by the NIS server. All the information is stored in a map within this domain. Every NIS map contains data records consisting of the index key and the information record.</p> <p>Depending on the administrative area you need to access, the default value is assigned to the domain. But this can be modified by UNICON using the “Configure Server Profile” option.</p>
BINDER_ENABLE	TRUE	TRUE FALSE	<p>Explanation: If this parameter is set to TRUE, NIS Client can access information from the NIS Server stored in the NIS maps. If this parameter is set to FALSE, the information from the NIS maps cannot be accessed by the NIS Client and only information stored in the local files can be accessed.</p> <p>This parameter can be modified by the following:</p> <ul style="list-style-type: none">◆ Using the “Configure Server Profile” option◆ Changing the status (Set or Reset) of the NIS Client Access field

Parameter Name	Default Value	Range of Values	Description
SV_DOMAIN			<p>Explanation: This parameter is used to specify the IP address of the server that serves the NIS Domain.</p> <p>For example, the parameter can be set as follows:</p> <p>sv_Marketing 193.97.54.18 (here Marketing is the name of the default NIS Domain)</p>
DB_PATH	SYS:ETC\NIS		<p>Explanation: It is the path to the NIS database where the mappings are stored.</p>
INTER_DOMAIN_RESOLUTION	TRUE	TRUE FALSE	<p>Explanation: If this parameter is set to TRUE, then DNS is enabled for resolution. If it is set to FALSE, then DNS is not enabled for resolution.</p>
MAP_REFRESH_DEFAULT	24:00:00		<p>Explanation: When any parameter is changed, the changes are reflected in all the NIS mappings. Using this parameter, you can specify the interval by which any changes should be updated in all the NIS mappings.</p> <p>Note: This parameter can be overridden by the MAP_REFRESH_MAPNAME parameter.</p>

Parameter Name	Default Value	Range of Values	Description
MAP_REFRESH_MAPNAME			<p>Explanation: This parameter is used to override the default refresh time for any specific parameter as specified by the MAP_REFRESH_DEFAULT parameter. MAPNAME here refers to any parameter whose default value is to be changed.</p> <p>For example:</p> <p>MAP_REFRESH_PASSWD.BYNAM E 01:00:00</p> <p>Here, the default refresh time for the PASSWD.BYNAME parameter is changed to 1:00 hours.</p>

PLPD

Parameter Name	Default Value	Range of Values	Description
REMOTE_PLPD_USER			<p>Explanation: This is the NetWare user name to be used for printing jobs if the queue exists on a 3.x server and PLPD is running on another server. This parameter is used to submit jobs to the queue, and this information is seen on the banner page.</p> <p>Note: The user name specified here should be a valid NetWare user on the 3.x server with appropriate printing rights.</p>
PLPD_POLL_TIME	120 secs	30 - 1000 secs	<p>Explanation: When PLPD is loaded, the value of this parameter is read from the NWPARAMS file under the PRINT_ADMIN section. If the parameter is not found, a default value of 120 seconds is assigned. In case the value is present in the NWPARAMS file, it is checked against a lower limit of 30 seconds and an upper limit of 1000 seconds. If the value falls outside these limits, a default value of 120 seconds is assigned.</p>
USE_ANY_PORT	0	0 1	<p>Explanation: By default, PLPD does not allow port numbers greater than 1024. If the user wishes to use a number greater than 1024, the value of this parameter should be set to 1 in the NWPARAMS file.</p>

T *rademarks*

Novell, Inc. has attempted to supply trademark information about company names, products, and services mentioned in this manual. The following list of trademarks was derived from various sources.

Novell Trademarks

Access Manager is a registered trademark of Novell, Inc. in the United States and other countries.

Advanced NetWare is a trademark of Novell, Inc.

AlarmPro is a registered trademark of Novell, Inc. in the United States and other countries.

AppNotes is a trademark of Novell, Inc.

AppTester is a trademark of Novell, Inc. in the United States.

BrainShare is a registered service mark of Novell, Inc. in the United States and other countries.

C-Worthy is a trademark of Novell, Inc.

C3PO is a trademark of Novell, Inc.

CBASIC is a registered trademark of Novell, Inc. in the United States and other countries.

Certified NetWare Administrator in Japanese and CNA-J are service marks of Novell, Inc.

Certified NetWare Engineer in Japanese and CNE-J are service marks of Novell, Inc.

Certified NetWare Instructor in Japanese and CNI-J are service marks of Novell, Inc.

Certified Novell Administrator and CNA are service marks of Novell, Inc.

Certified Novell Engineer and CNE are service marks of Novell, Inc.

Certified Novell Salesperson is a trademark of Novell, Inc.

Client 32 is a trademark of Novell, Inc.

ConnectView is a registered trademark of Novell, Inc. in the United States and other countries.

Connectware is a trademark of Novell, Inc.

Corsair is a registered trademark of Novell, Inc. in the United States and other countries.

CP/Net is a registered trademark of Novell, Inc. in the United States and other countries.

Custom 3rd-Party Object and C3PO are trademarks of Novell, Inc.

DeveloperNet is a trademark of Novell, Inc.

Documenter's Workbench is a registered trademark of Novell, Inc. in the United States and other countries.

ElectroText is a trademark of Novell, Inc.

Enterprise Certified Novell Engineer and ECNE are service marks of Novell, Inc.

Envoy is a registered trademark of Novell, Inc. in the United States and other countries.

EtherPort is a registered trademark of Novell, Inc. in the United States and other countries.

EXOS is a trademark of Novell, Inc.

Global MHS is a trademark of Novell, Inc.

Global Network Operations Center and GNOC are service marks of Novell, Inc.

Grammatik is a registered trademark of Novell, Inc. in the United States and other countries.

Graphics Environment Manager and GEM are registered trademarks of Novell, Inc. in the United States and other countries.

GroupWise is a registered trademark of Novell, Inc. in the United States and other countries.

GroupWise 5 is a trademark of Novell, Inc.

GroupWise XTD is a trademark of Novell, Inc.

Hardware Specific Module and HSM are trademarks of Novell, Inc.

Hot Fix is a trademark of Novell, Inc.

InForms is a trademark of Novell, Inc.

Instructional Workbench is a registered trademark of Novell, Inc. in the United States and other countries.

Internetwork Packet Exchange and IPX are trademarks of Novell, Inc.

IPX/SPX is a trademark of Novell, Inc.

IPXODI is a trademark of Novell, Inc.

IPXWAN is a trademark of Novell, Inc.

LAN WorkGroup is a trademark of Novell, Inc.

LAN WorkPlace is a registered trademark of Novell, Inc. in the United States and other countries.

LAN WorkShop is a trademark of Novell, Inc.

LANalyzer is a registered trademark of Novell, Inc. in the United States and other countries.

LANalyzer Agent is a trademark of Novell, Inc.

Link Support Layer and LSL are trademarks of Novell, Inc.

MacIPX is a registered trademark of Novell, Inc. in the United States and other countries.

ManageWise is a registered trademark of Novell, Inc. in the United States and other countries.

Media Support Module and MSM are trademarks of Novell, Inc.
Mirrored Server Link and MSL are trademarks of Novell, Inc.
Mobile IPX is a trademark of Novell, Inc.
Multiple Link Interface and MLI are trademarks of Novell, Inc.
Multiple Link Interface Driver and MLID are trademarks of Novell, Inc.
My World is a registered trademark of Novell, Inc. in the United States and other countries.
N-Design is a registered trademark of Novell, Inc. in the United States and other countries.
Natural Language Interface for Help is a trademark of Novell, Inc.
NDS is a trademark of Novell, Inc.
NDS Manager is a trademark of Novell, Inc.
NE/2 is a trademark of Novell, Inc.
NE/2-32 is a trademark of Novell, Inc.
NE/2T is a trademark of Novell, Inc.
NE1000 is a trademark of Novell, Inc.
NE1500T is a trademark of Novell, Inc.
NE2000 is a trademark of Novell, Inc.
NE2000T is a trademark of Novell, Inc.
NE2100 is a trademark of Novell, Inc.
NE21500T is a trademark of Novell, Inc.
NE3200 is a trademark of Novell, Inc.
NE32HUB is a trademark of Novell, Inc.
NEST is a trademark of Novell, Inc.
NEST Autoroute is a trademark of Novell, Inc.
NetExplorer is a trademark of Novell, Inc.
NetNotes is a registered trademark of Novell, Inc. in the United States and other countries.
NetSync is a trademark of Novell, Inc.
NetWare is a registered trademark of Novell, Inc. in the United States and other countries.
NetWare 3 is a trademark of Novell, Inc.
NetWare 3270 CUT Workstation is a trademark of Novell, Inc.
NetWare 3270 LAN Workstation is a trademark of Novell, Inc.
NetWare 386 is a trademark of Novell, Inc.
NetWare 4 is a trademark of Novell, Inc.
NetWare 5 is a trademark of Novell, Inc.
NetWare Access Server is a trademark of Novell, Inc.
NetWare Access Services is a trademark of Novell, Inc.
NetWare Application Manager is a trademark of Novell, Inc.
NetWare Application Notes is a trademark of Novell, Inc.
NetWare Asynchronous Communication Services and NACS are trademarks of Novell, Inc.

NetWare Asynchronous Services Interface and NASI are trademarks of Novell, Inc.

NetWare Aware is a trademark of Novell, Inc.

NetWare Basic MHS is a trademark of Novell, Inc.

NetWare BranchLink Router is a trademark of Novell, Inc.

NetWare Care is a trademark of Novell, Inc.

NetWare Communication Services Manager is a trademark of Novell, Inc.

NetWare Connect is a registered trademark of Novell, Inc. in the United States.

NetWare Core Protocol and NCP are trademarks of Novell, Inc.

NetWare Distributed Management Services is a trademark of Novell, Inc.

NetWare Document Management Services is a trademark of Novell, Inc.

NetWare DOS Requester and NDR are trademarks of Novell, Inc.

NetWare Enterprise Router is a trademark of Novell, Inc.

NetWare Express is a registered service mark of Novell, Inc. in the United States and other countries.

NetWare Global Messaging and NGM are trademarks of Novell, Inc.

NetWare Global MHS is a trademark of Novell, Inc.

NetWare HostPrint is a registered trademark of Novell, Inc. in the United States.

NetWare IPX Router is a trademark of Novell, Inc.

NetWare LANalyzer Agent is a trademark of Novell, Inc.

NetWare Link Services Protocol and NLSP are trademarks of Novell, Inc.

NetWare Link/ATM is a trademark of Novell, Inc.

NetWare Link/Frame Relay is a trademark of Novell, Inc.

NetWare Link/PPP is a trademark of Novell, Inc.

NetWare Link/X.25 is a trademark of Novell, Inc.

NetWare Loadable Module and NLM are trademarks of Novell, Inc.

NetWare LU6.2 is trademark of Novell, Inc.

NetWare Management Agent is a trademark of Novell, Inc.

NetWare Management System and NMS are trademarks of Novell, Inc.

NetWare Message Handling Service and NetWare MHS are trademarks of Novell, Inc.

NetWare MHS Mailslots is a registered trademark of Novell, Inc. in the United States and other countries.

NetWare Mirrored Server Link and NMSL are trademarks of Novell, Inc.

NetWare Mobile is a trademark of Novell, Inc.

NetWare Mobile IPX is a trademark of Novell, Inc.

NetWare MultiProtocol Router and NetWare MPR are trademarks of Novell, Inc.

NetWare MultiProtocol Router Plus is a trademark of Novell, Inc.

NetWare Name Service is a registered trademark of Novell, Inc. in the United States and other countries.

NetWare Navigator is a trademark of Novell, Inc.

NetWare Peripheral Architecture is a trademark of Novell, Inc.

NetWare Print Server is a trademark of Novell, Inc.
NetWare Ready is a trademark of Novell, Inc.
NetWare Requester is a trademark of Novell, Inc.
NetWare Runtime is a trademark of Novell, Inc.
NetWare RX-Net is a trademark of Novell, Inc.
NetWare SFT is a trademark of Novell, Inc.
NetWare SFT III is a trademark of Novell, Inc.
NetWare SNA Gateway is a trademark of Novell, Inc.
NetWare SNA Links is a trademark of Novell, Inc.
NetWare SQL is a trademark of Novell, Inc.
NetWare Storage Management Services and NetWare SMS are trademarks of Novell, Inc.
NetWare Telephony Services is a trademark of Novell, Inc.
NetWare Tools is a trademark of Novell, Inc.
NetWare UAM is a trademark of Novell, Inc.
NetWare WAN Links is a trademark of Novell, Inc.
NetWare/IP is a trademark of Novell, Inc.
NetWire is a registered service mark of Novell, Inc. in the United States and other countries.
Network Navigator is a registered trademark of Novell, Inc. in the United States.
Network Navigator - AutoPilot is a registered trademark of Novell, Inc. in the United States and other countries.
Network Navigator - Dispatcher is a registered trademark of Novell, Inc. in the United States.
Network Support Encyclopedia and NSE are trademarks of Novell, Inc.
Network Support Encyclopedia Professional Volume and NSEPro are trademarks of Novell, Inc.
NetWorld is a registered service mark of Novell, Inc. in the United States and other countries.
Novell is a service mark of Novell, Inc. and a registered trademark of Novell, Inc. in the United States and other countries.
Novell Academic Education Partner and NAEP are service marks of Novell, Inc.
Novell Alliance Partners Program is a collective mark of Novell, Inc.
Novell Application Launcher is a trademark of Novell, Inc.
Novell Application Notes is a trademark of Novell, Inc.
Novell Authorized CNE is a trademark and service mark of Novell, Inc.
Novell Authorized Education Center and NAEC are service marks of Novell, Inc.
Novell Authorized Partner is a service mark of Novell, Inc.
Novell Authorized Reseller is a service mark of Novell, Inc.
Novell Authorized Service Center and NASC are service marks of Novell, Inc.
Novell BorderManager is a trademark of Novell, Inc.
Novell BorderManager FastCache is a trademark of Novell, Inc.

Novell Client is a trademark of Novell, Inc.
Novell Corporate Symbol is a trademark of Novell, Inc.
Novell Customer Connections is a registered trademark of Novell, Inc. in the United States.
Novell Directory Services and NDS are trademarks of Novell, Inc.
Novell Distributed Print Services and NDPS are trademarks of Novell, Inc.
Novell ElectroText is a trademark of Novell, Inc.
Novell Embedded Systems Technology is a registered trademark of Novell, Inc. in the United States and other countries and
NEST is a trademark of Novell, Inc.
Novell Gold Authorized Reseller is a service mark of Novell, Inc.
Novell Gold Partner is a service mark of Novell, Inc.
Novell Labs is a trademark of Novell, Inc.
Novell N-Design is a registered trademark of Novell, Inc. in the United States and other countries.
Novell NE/2 is a trademark of Novell, Inc.
Novell NE/2-32 is a trademark of Novell, Inc.
Novell NE3200 is a trademark of Novell, Inc.
Novell Network Registry is a service mark of Novell, Inc.
Novell Platinum Partner is a service mark of Novell, Inc.
Novell Press is a trademark of Novell, Inc.
Novell Press Logo (teeth logo) is a registered trademark of Novell, Inc. in the United States and other countries.
Novell Replication Services is a trademark of Novell, Inc.
Novell Research Reports is a trademark of Novell, Inc.
Novell RX-Net/2 is a trademark of Novell, Inc.
Novell Service Partner is a trademark of Novell, Inc.
Novell Storage Services is a trademark of Novell, Inc.
Novell Support Connection is a trademark of Novell, Inc.
Novell Technical Services and NTS are service marks of Novell, Inc.
Novell Technology Institute and NTI are registered service marks of Novell, Inc. in the United States and other countries.
Novell Virtual Terminal and NVT are trademarks of Novell, Inc.
Novell Web Server is a trademark of Novell, Inc.
Novell World Wide is a trademark of Novell, Inc.
NSE Online is a service mark of Novell, Inc.
NTR2000 is a trademark of Novell, Inc.
Nutcracker is a registered trademark of Novell, Inc. in the United States and other countries.
OnLAN/LAP is a registered trademark of Novell, Inc. in the United States and other countries.
OnLAN/PC is a registered trademark of Novell, Inc. in the United States and other countries.
Open Data-Link Interface and ODI are trademarks of Novell, Inc.

Open Look is a registered trademark of Novell, Inc. in the United States and other countries.

Open Networking Platform is a registered trademark of Novell, Inc. in the United States and other countries.

Open Socket is a registered trademark of Novell, Inc. in the United States.

Packet Burst is a trademark of Novell, Inc.

PartnerNet is a trademark and service mark of Novell, Inc.

PC Navigator is a trademark of Novell, Inc.

PCOX is a registered trademark of Novell, Inc. in the United States and other countries.

Perform3 is a trademark of Novell, Inc.

Personal NetWare is a trademark of Novell, Inc.

Pervasive Computing from Novell is a registered trademark of Novell, Inc. in the United States and other countries.

Portable NetWare is a trademark of Novell, Inc.

Presentation Master is a registered trademark of Novell, Inc. in the United States and other countries.

Print Managing Agent is a trademark of Novell, Inc.

Printer Agent is a trademark of Novell, Inc.

QuickFinder is a trademark of Novell, Inc.

Red Box is a trademark of Novell, Inc.

Reference Software is a registered trademark of Novell, Inc. in the United States and other countries.

Remote Console is a trademark of Novell, Inc.

Remote MHS is a trademark of Novell, Inc.

RX-Net is a trademark of Novell, Inc.

RX-Net/2 is a trademark of Novell, Inc.

ScanXpress is a registered trademark of Novell, Inc. in the United States and other countries.

Script Director is a registered trademark of Novell, Inc. in the United States and other countries.

Sequenced Packet Exchange and SPX are trademarks of Novell, Inc.

Service Response System is a trademark of Novell, Inc.

Serving FTP is a trademark of Novell, Inc.

SFT is a trademark of Novell, Inc.

SFT III is a trademark of Novell, Inc.

SoftSolutions is a registered trademark of SoftSolutions Technology Corporation, a wholly owned subsidiary of Novell, Inc.

Software Transformation, Inc. is a registered trademark of Software Transformation, Inc., a wholly owned subsidiary of Novell, Inc.

SPX/IPX is a trademark of Novell, Inc.

StarLink is a registered trademark of Novell, Inc. in the United States and other countries.

Storage Management Services and SMS are trademarks of Novell, Inc.

Technical Support Alliance and TSA are collective marks of Novell, Inc.

The Fastest Way to Find the Right Word is a registered trademark of Novell, Inc. in the United States and other countries.

The Novell Network Symbol is a trademark of Novell, Inc.

Topology Specific Module and TSM are trademarks of Novell, Inc.

Transaction Tracking System and TTS are trademarks of Novell, Inc.

Universal Component System is a registered trademark of Novell, Inc. in the United States and other countries.

Virtual Loadable Module and VLM are trademarks of Novell, Inc.

Writer's Workbench is a registered trademark of Novell, Inc. in the United States and other countries.

Yes, It Runs with NetWare (logo) is a trademark of Novell, Inc.

Yes, NetWare Tested and Approved (logo) is a trademark of Novell, Inc.

Yes, Tested and Approved is a trademark of Novell, Inc.

Z.E.N.works is a trademark of Novell, Inc.

Third-Party Trademarks

All third-party trademarks are the property of their respective owners.