

# Contents

## How to Use This Manual

Checklist for Installing and Setting Up Your Network . . . . .	xvii
Managing Your Network . . . . .	xviii
Command Syntax Conventions . . . . .	xix
User Comments . . . . .	xx

## 1 Managing NetWare Directory Services Objects

Default Objects and Rights for NetWare 4.11 . . . . .	2
Setting Up Administration Utilities . . . . .	5
Setting up NetWare Administrator on a Windows 3.1 Workstation . . . . .	5
Setting up NetWare Administrator on a Windows 95 Workstation . . . . .	7
Setting up NetWare Administrator on an OS/2 Workstation . . . . .	8
Rights Needed to Create and Manage Objects . . . . .	9
Object Rights . . . . .	11
Property Rights . . . . .	12
Managing Trustee Assignments to Objects . . . . .	13
Using NetWare Administrator to Manage Trustee Assignments . . . . .	14
Using NETADMIN to Manage Trustee Assignments . . . . .	15
Creating Container Objects . . . . .	16
Types of Container Objects . . . . .	16
Naming Container Objects . . . . .	19
Creating Searchable Container Objects . . . . .	21
Creating Container Objects Using INSTALL . . . . .	21
Creating Container Objects Using NetWare Administrator . . . . .	22
Creating Container Objects Using NETADMIN . . . . .	23
Creating Leaf Objects . . . . .	26
How to Use Leaf Objects . . . . .	27
Naming Leaf Objects . . . . .	33
Creating Searchable Leaf Objects . . . . .	35
Creating Leaf Objects Using NetWare Administrator . . . . .	36
Creating Leaf Objects Using NETADMIN . . . . .	37
Managing Groups of User Objects . . . . .	40
Managing Group Objects . . . . .	41

Managing Profile Objects . . . . .	51
Managing Organizational Role Objects . . . . .	55
Managing User Templates . . . . .	60
Searching for Objects . . . . .	64
Searching for Objects Using NetWare Administrator . . . . .	64
Searching for Objects Using NETADMIN . . . . .	66
Searching for Objects Using NLIST . . . . .	68
Moving Objects in the Directory Tree . . . . .	68
Moving Leaf Objects Using NetWare Administrator . . . . .	69
Moving Leaf Objects Using NetWare Administrator (Drag-and-Drop) . . . . .	71
Moving Leaf Objects Using NETADMIN . . . . .	72
Moving Container Objects Using NetWare Administrator . . . . .	74
Moving Container Objects Using NETADMIN . . . . .	76
Deleting Objects from the Directory Tree . . . . .	78
Cautions When Deleting NetWare Server Objects . . . . .	79
Cautions When Deleting User Objects . . . . .	79
Cautions When Deleting Alias Objects . . . . .	80
Deleting Objects Using NetWare Administrator . . . . .	81
Deleting Objects Using NETADMIN . . . . .	82
Renaming Leaf and Container Objects . . . . .	83
Renaming Objects Using NetWare Administrator . . . . .	84
Renaming Objects Using NETADMIN . . . . .	85
Changing Object Property Values . . . . .	87
Changing Object Property Values Using NetWare Administrator . . . . .	87
Changing Object Property Values Using NETADMIN . . . . .	91

## **2 Managing Directories, Files, and Applications**

Planning Directory Structures . . . . .	97
System-Created Directories . . . . .	97
High Capacity Storage System (HCSS) Directories . . . . .	98
Workstation Operating System Directories . . . . .	98
Application Directories . . . . .	99
Data Directories . . . . .	99
Sample Directory Structure . . . . .	99
Creating Directories and Copying Files . . . . .	100
Creating Directories Using NetWare Administrator . . . . .	101
Creating Directories Using FILER . . . . .	103
Copying or Moving Files Using NetWare Administrator . . . . .	104
Copying or Moving Files Using FILER . . . . .	106
Loading Operating Systems and Applications onto the Network . . . . .	109
Loading DOS onto the Network . . . . .	109
Loading MS Windows onto the Network . . . . .	111
Loading Other Applications onto the Network . . . . .	116

Assigning Trustee Rights to Operating System and Application Directories . . . . .	117
Creating and Using Directory Map Objects . . . . .	118
How to Use Directory Map Objects . . . . .	118
Creating a Directory Map Object . . . . .	119
Setting Up and Using NetWare Application Management Software . . . . .	123
Setting Up NetWare Application Manager. . . . .	123
Setting Up NetWare Application Launcher . . . . .	125
Configuring NetWare Application Launcher. . . . .	129
Creating and Using NetWare Application Objects. . . . .	129
Making the File System Secure and Accessible . . . . .	133
Understanding File and Directory Rights . . . . .	133
Adding a Trustee to a Directory or File . . . . .	135
Deleting a Trustee from a Directory or File . . . . .	139
Modifying a Trustee's Rights to a Directory or File . . . . .	142
Viewing/Modifying the Inherited Rights Filter for Directories and Files . . . . .	145
Changing Attributes of a Directory or File . . . . .	148
Changing the Owner of a Directory or File . . . . .	151
Viewing Effective Rights and Other Information . . . . .	154
Viewing a Trustee's Effective Rights to a Directory or File . . . . .	154
Viewing Other Information about a Directory or File . . . . .	157
Salvaging and Purging Deleted Files and Directories. . . . .	162
Salvaging Deleted Files . . . . .	162
Purging Files . . . . .	166

### 3 Creating Login Scripts

About Login Scripts . . . . .	169
Four Types of Login Scripts . . . . .	169
Deciding Which Login Scripts to Create. . . . .	171
Using Login Scripts from Other NetWare Versions . . . . .	173
Creating, Modifying, Copying, and Printing Login Scripts. . . . .	174
Login Script Hints . . . . .	175
Creating or Modifying a Login Script Using NetWare Administrator. . . . .	177
Creating or Modifying a Login Script Using NETADMIN . . . . .	179
Copying a Login Script Using NetWare Administrator. . . . .	183
Copying a Login Script Using NETADMIN . . . . .	184
Printing Login Scripts . . . . .	186
Login Script Commands and Variables . . . . .	187
# (Execute External Program) . . . . .	188
ATTACH . . . . .	189
BREAK . . . . .	190
CLS . . . . .	191
COMSPEC . . . . .	191
CONTEXT . . . . .	193

DISPLAY . . . . .	194
DOS BREAK . . . . .	195
DOS SET . . . . .	196
DOS VERIFY . . . . .	196
DRIVE . . . . .	197
EXIT . . . . .	198
FDISPLAY . . . . .	199
FIRE PHASERS . . . . .	200
GOTO . . . . .	202
IF...THEN . . . . .	203
INCLUDE . . . . .	206
LASTLOGINTIME . . . . .	209
MACHINE . . . . .	210
MAP . . . . .	210
NO_DEFAULT . . . . .	219
NOSWAP . . . . .	220
PAUSE . . . . .	221
PCCOMPATIBLE . . . . .	221
PROFILE . . . . .	222
REMARK . . . . .	223
SCRIPT_SERVER . . . . .	224
SET . . . . .	224
SET_TIME . . . . .	227
SHIFT . . . . .	228
SWAP . . . . .	230
TEMP SET . . . . .	231
WRITE . . . . .	232
Identifier Variables . . . . .	234
Using Identifier Variables . . . . .	238
Using LOGIN Parameters with %n Variables . . . . .	239
Examples of Login Scripts . . . . .	240
Default Login Script . . . . .	240
Container Login Script . . . . .	242
Profile Login Script . . . . .	245
User Login Script . . . . .	246

## 4 Maintaining NetWare 4 Networks

Introduction . . . . .	250
Ensuring Software and Utilities Are Current . . . . .	250
Testing Software and Hardware in a Lab Environment . . . . .	250
Identifying Network Monitoring and Maintenance Tools . . . . .	251
Viewing and Editing the Repair Log File . . . . .	253
Monitoring and Maintaining Network Communication . . . . .	254



Monitoring Communication Links . . . . .	254
Resolving Communication Failures . . . . .	255
Monitoring and Maintaining Replica Synchronization . . . . .	256
Determining Replica Synchronization Status . . . . .	257
Monitoring and Maintaining Time Synchronization . . . . .	262
Determining Time Synchronization Status . . . . .	262
Ensuring that the Server's DOS Clock Is Accurate . . . . .	264
Setting Time in NetWare 4 . . . . .	264
Maintaining Network Time Synchronization . . . . .	266
Monitoring and Maintaining Network Hardware . . . . .	278
Bringing an NDS Server or WAN Link Down . . . . .	278
Planned Backup for Hardware Upgrade. . . . .	283
Resolving Hard Disk Failures . . . . .	285
Monitoring and Maintaining Network Data . . . . .	289
Maintaining Sufficient Disk Space for Volume SYS: . . . . .	289
Maintaining and Monitoring Backward Compatibility . . . . .	290
Maintaining Bindery Services in a NetWare 4 Environment. . . . .	290
Maintaining Replicas in a Mixed NetWare 4 Environment . . . . .	292

## 5 Managing the NetWare Directory Tree

About NetWare Directory Services . . . . .	295
Creating and Managing Directory Services Partitions. . . . .	296
About Partitions and Replicas . . . . .	296
Planning and Using Partitions and Replicas . . . . .	297
Setting Up NDS Manager . . . . .	297
Controlling Access to NDS Manager . . . . .	299
Creating a New Partition . . . . .	299
Merging Partitions . . . . .	301
Moving a Partition . . . . .	303
Aborting a Partition Operation. . . . .	306
Creating a Replica. . . . .	308
Deleting a Replica . . . . .	310
Sending Updates to Other Replicas. . . . .	311
Receiving Updates from Other Replicas . . . . .	313
Viewing a List of Partitions Stored on a NetWare Server . . . . .	314
Viewing a List of Replicas of a Partition . . . . .	316
Viewing a List of Partitions in a Directory Tree . . . . .	317
Changing a Replica's Type . . . . .	317
Removing NetWare Directory Services from a Server . . . . .	319
Considerations Before Removing NDS . . . . .	319
Removing NDS from a Server. . . . .	320
Reinstalling NDS on a Server . . . . .	321
Deleting a NetWare Server Object from the NDS Database . . . . .	322

Considerations Before Deleting NetWare Server Objects . . . . .	322
Deleting a NetWare Server Object Using PARTMGR . . . . .	323
Repairing the NetWare Directory Database . . . . .	324
DSREPAIR Overview . . . . .	324
DSREPAIR Options . . . . .	326
Running an Unattended Full Repair . . . . .	327
Checking Time Synchronization (DSREPAIR) . . . . .	328
Checking Replica Synchronization . . . . .	330
Viewing and Editing the Repair Log File . . . . .	333
Using the Advanced Options . . . . .	333
Merging NDS Trees . . . . .	335
DSMERGE Overview. . . . .	335
Preparing the Source and Target Trees . . . . .	337
Time Synchronization before the Merge . . . . .	338
DSMERGE Options . . . . .	338
Checking Servers in the Tree . . . . .	340
Checking Time Synchronization (DSMERGE) . . . . .	342
Merging Two Trees. . . . .	343
Renaming the Tree. . . . .	345
Completing the Tree Merge . . . . .	347
Viewing and Managing NDS Synchronization Status . . . . .	348

## **6 Migrating Data Using the High Capacity Storage System**

What is the High Capacity Storage System? . . . . .	351
HCSS Concepts . . . . .	352
How the HCSS File System Is Structured . . . . .	352
What Happens When Data Migrates . . . . .	354
Media Access Control . . . . .	355
Media Export and Import Operations. . . . .	356
Restrictions. . . . .	357
Overview of HCSS Setup and Management. . . . .	358
How the HCSS File System Is Managed. . . . .	358
Installing and Setting Up HCSS . . . . .	360
Installing Hardware. . . . .	360
Loading HCSS Drivers . . . . .	361
Creating an HCSS Volume. . . . .	362
Loading HCSS on the Server . . . . .	363
Setting Up a Windows 3.x Workstation to Manage HCSS . . . . .	365
Setting Up a Windows 95 Workstation to Manage HCSS . . . . .	367
Setting Up the HCSS File System . . . . .	369
Managing the HCSS File System . . . . .	378
Exporting Media . . . . .	379
Reloading Media . . . . .	381

Deleting an HCSS Domain Directory . . . . .	382
Reformatting Media . . . . .	383
Checking Media Status . . . . .	384
Managing HCSS Parameters . . . . .	384
What the Parameters Do . . . . .	385
Setting Parameters Using NetWare Administrator . . . . .	390
Setting Parameters at the Server Console . . . . .	397

## 7 Maintaining the NetWare Server

Common Management Tasks . . . . .	402
Sending Console Messages to Workstations . . . . .	402
Bringing Down a Server . . . . .	405
Loading a NetWare Loadable Module . . . . .	406
Loading and Binding LAN Drivers . . . . .	407
Viewing and Adding Server Search Paths . . . . .	410
Installing, Uninstalling, and Configuring a Server Product . . . . .	412
Copying NetWare Files . . . . .	413
Extracting NetWare Files from the Installation CD-ROM . . . . .	414
Creating or Editing a Server Batch (.NCF) File . . . . .	416
Placing Optional Commands in a Server Batch (.NCF) File . . . . .	417
Editing Text Files from the Server Console . . . . .	418
Setting a Server's Language . . . . .	421
Specifying a Language for an NLM . . . . .	425
Changing the Server Keyboard Type . . . . .	426
Viewing and Setting Server Time and Time Zone . . . . .	427
Changing a Server's Name or IPX Internal Network Number . . . . .	430
Managing Server Connections . . . . .	431
Disabling and Enabling Logins . . . . .	431
Clearing a Workstation Connection . . . . .	431
Monitoring Workstation Connections . . . . .	433
Increasing the Maximum Number of Packet Receive Buffers . . . . .	435
Increasing the Minimum Number of Packet Receive Buffers . . . . .	436
Avoiding Bottlenecks During Peak Usage . . . . .	437
Monitoring and Optimizing the Server . . . . .	439
Assessing Server RAM . . . . .	439
Controlling Memory Allocation . . . . .	440
Speeding Directory Searches . . . . .	442
Prioritizing Server Processes . . . . .	443
Checking a Server's Processor Utilization . . . . .	445
Viewing a Server's Packet Traffic . . . . .	446
Viewing LAN Driver Statistics . . . . .	447
Improving Server Performance . . . . .	448
Improving Disk Writes . . . . .	449

Improving Disk Reads . . . . .	454
Controlling Resource Allocation with Locks . . . . .	457
Displaying Alert Messages . . . . .	460
Viewing the Server Error Log. . . . .	463
Managing Error Log Files . . . . .	465
Checking for Disk Errors . . . . .	466
Maintaining Volumes . . . . .	468
Creating Volumes . . . . .	469
Mounting and Dismounting Volumes . . . . .	471
Deleting Volumes. . . . .	472
Renaming Volumes . . . . .	473
Setting Up a Volume to Store Non-DOS Files . . . . .	475
Repairing Volumes . . . . .	477
Adding a Segment to an Existing Volume . . . . .	481
Modifying the Size of a Volume . . . . .	482
Using a CD-ROM as a NetWare Volume. . . . .	483
Managing Server Hard Disks . . . . .	489
Checking Available Disk Space with NDIR. . . . .	489
Using File Compression . . . . .	490
Enabling File Compression on a Volume. . . . .	491
Setting Compression for a File or Directory . . . . .	492
Suspending File Compression . . . . .	496
Using SET to Control File Compression . . . . .	497
Purging Files from a Disk. . . . .	499
Adding Optical Storage for File Migration . . . . .	501
Adding a Hard Disk to the NetWare Server . . . . .	501
Replacing a Hard Disk . . . . .	506
Loading Disk Drivers . . . . .	508
Creating NetWare Disk Partitions . . . . .	511
Deleting NetWare Disk Partitions . . . . .	513
Mirroring and Duplexing a Hard Disk. . . . .	514
Unmirroring Hard Disks . . . . .	517
Disaster Prevention and Recovery. . . . .	519
Securing the Server Console. . . . .	519
Preventing Virus Infection . . . . .	520
Preventing Packet Forgery . . . . .	521
Activating UPS Monitoring . . . . .	528
Protecting Database Integrity with TTS . . . . .	535
Mirroring and Duplexing to Protect Data . . . . .	537
Recovering Data from an Unmirrored (Out of Sync) Hard Disk . . . . .	537
Using Remote Console to Manage a Server. . . . .	538
Understanding Connection Types . . . . .	539
Running a Remote Console Session Through a Direct Connection . . . . .	539
Running a Remote Console Session Over a Modem . . . . .	545

Loading Remote Modules on Bootup . . . . .	551
Upgrading Files on a Remote Server . . . . .	553
Installing or Reconfiguring Applications on a Remote Server . . . . .	554
Rebooting a Remote Server. . . . .	556
Administering Accounting . . . . .	558
Setting Up Accounting. . . . .	558
Calculating Charge Rates for Accounting . . . . .	560
Viewing Accounting Totals . . . . .	561

## 8 Maintaining NetWare SMP

Installing and Uninstalling NetWare SMP . . . . .	565
Installing NetWare SMP . . . . .	565
Uninstalling NetWare SMP . . . . .	566
Multiprocessing Overview . . . . .	567
Uniprocessing vs. Multiprocessing . . . . .	567
Multithreaded Applications . . . . .	567
Architecture of NetWare SMP. . . . .	568
Monitoring SMP Performance. . . . .	573
Assessing the Statistics . . . . .	573
SMP Statistics in the “General Information” Window . . . . .	574
Statistics Accessed through the “Multiprocessor Information” Option. . . . .	574
Disabling and Enabling Processors . . . . .	584
Using SMP SET Parameters . . . . .	586

## 9 Backing Up and Restoring Data

Understanding Storage Management Services (SMS) . . . . .	592
Understanding Target Service Agents (TSAs) . . . . .	593
Understanding Supported Storage Devices and Drivers . . . . .	593
Understanding the Storage Management Engine (SME) . . . . .	594
Understanding Backup for the NetWare Directory Database . . . . .	603
Understanding Backup for the File System . . . . .	608
Loading Drivers, TSAs, and Backup Software . . . . .	610
Loading Controller and Storage Device Drivers on the Server . . . . .	610
Loading TSAs . . . . .	611
Loading SBACKUP on the Server. . . . .	612
Backing Up Data . . . . .	613
Procedures for Custom Backups . . . . .	620
Loading Software for Backing Up Workstations. . . . .	624
Loading SMS Software for Backing Up SFT III Servers. . . . .	627
Understanding Restoring Using SMS . . . . .	628
How SMS Restores Data . . . . .	628
Understanding Restore Issues with NetWare Directory Services. . . . .	630

Restore Sessions . . . . .	633
Restore Options . . . . .	633
Restoring Data . . . . .	635
Beginning Procedures for Restoring NDS . . . . .	642
Types of Restore Sessions . . . . .	647
Procedures for Completing the Restore . . . . .	654
Restoring Information for Special Conditions . . . . .	656
Unloading SMS Files . . . . .	657
Other SBACKUP Tasks . . . . .	658
Prerequisites for Other SBACKUP Tasks . . . . .	659
Log and Error Files . . . . .	659
Viewing a Log File . . . . .	661
Viewing an Error File . . . . .	662
Creating Log and Error Files . . . . .	664
Setting Location of Log and Error Files . . . . .	665
Deleting the Log Files for Overwritten Sessions . . . . .	666
Verifying Backup Data . . . . .	667
Administering Storage Devices . . . . .	670
Changing Targets . . . . .	675
Enhancing SBACKUP Performance . . . . .	676
Compressed Files . . . . .	676
Enhancing Host Server Performance . . . . .	677
Troubleshooting . . . . .	680

## 10 Managing NetWare Licensing Services

Understanding Software Licensing . . . . .	683
Understanding NetWare Licensing Services . . . . .	684
NLS Components . . . . .	684
License Service Providers . . . . .	685
LSP Server Objects . . . . .	686
NLS Clients . . . . .	686
NLS and NDS: Considerations . . . . .	688
Installing NetWare Licensing Services . . . . .	692
Introducing NLS Manager . . . . .	693
Installing Certificates . . . . .	694
Installing a License Certificate . . . . .	695
Creating a Metering Certificate . . . . .	696
Managing Licenses . . . . .	697
Viewing Licensed Product Information . . . . .	697
Viewing License Certificate Information . . . . .	698
Assigning Licenses to Users . . . . .	699
Unassigning Licenses . . . . .	700
Assigning a New Owner to a License Certificate . . . . .	700

Viewing LSP Server Information . . . . .	701
--	-----

## **A Troubleshooting the Network**

Troubleshooting Hardware and Network Problems . . . . .	703
Identifying Problems After Installation . . . . .	703
Resolving Hard Disk Access Problems . . . . .	704
Making Computer Memory Available for Network Drivers . . . . .	705
Resolving Cabling Problems . . . . .	705
Power Supply Errors . . . . .	706
Troubleshooting the NetWare Server . . . . .	707
Resolving Abends . . . . .	707
Resolving Server I/O Errors . . . . .	712
Resolving Server Disk Space Problems . . . . .	713
Resolving Server Memory Problems . . . . .	714
Resolving Locked Device Errors . . . . .	715
Resolving File I/O Errors . . . . .	715
Resolving Volume I/O Errors . . . . .	716
Resolving Event Control Block Allocation Errors . . . . .	716
Resolving Server Console Command Problems . . . . .	717
Resolving Keyboard Locking Problems When Copying Files from CD-ROM . . . . .	718
Resolving Problems When Server “Hangs” After Mounting Last Volume . . . . .	721
Resolving Problem When No Volumes Mount . . . . .	722
Resolving Problems When Only Some Volumes Mount . . . . .	722
Resolving Disk Error Problems When a Volume Is Mounting . . . . .	723
Resolving Memory Errors When a Volume Is Mounting . . . . .	724
Resolving Volume Mounting Problems Because of Corrupted Directory Entry Tables or File Allocation Tables . . . . .	725
Resolving Volume Mounting Problems Because of Name Space Module . . . . .	727
Troubleshooting Communication Problems . . . . .	728
General Communication Problems . . . . .	728
Resolving Server Boot Problems After a Network Board Is Installed . . . . .	730
Resolving Problems When Workstations Can’t Communicate with a Server . . . . .	731
Resolving Communication Problems Between Servers . . . . .	732
Resolving Slow Server Response . . . . .	734
Resolving Periodic Loss of Connection . . . . .	735
Resolving ARCnet-Specific Software Problems . . . . .	736
Resolving ARCnet-Specific Hardware Problems . . . . .	737
Resolving Ethernet-Specific Software Problems . . . . .	738
Resolving Ethernet-Specific Hardware Problems . . . . .	739
Resolving Token Ring-Specific Software Problems . . . . .	740
Resolving Token Ring-Specific Hardware Problems . . . . .	741
Troubleshooting Workstations . . . . .	741
Resolving Workstation Memory Problems . . . . .	741

Resolving Workstation Disk Space Problems . . . . .	742
---	-----

## **B Managing NetWare Server for OS/2**

NetWare Server for OS/2 and NetWare 4 . . . . .	743
Loading NetWare Server for OS/2 . . . . .	744
Using NWOS2.EXE to Load the Server from the Command Line . . . . .	744
Using the OS/2 Graphical Interface to Load the Server . . . . .	744
Navigating in NetWare Server for OS/2 . . . . .	745
Using Loadable Modules in NetWare Server for OS/2. . . . .	745
Monitoring NetWare Server for OS/2 . . . . .	746
Loading PMMON . . . . .	746
Using PMMON . . . . .	748
Setting Performance Tuning . . . . .	748
Setting Memory Sharing . . . . .	749
Releasing Server Memory . . . . .	752
Supporting Workstations . . . . .	753
Configuring NetWare Server for OS/2 . . . . .	754
NET.CFG File Format . . . . .	754
Conventions for Entering NET.CFG Options . . . . .	755
Editing the NET.CFG File Using the Installation Program . . . . .	756
Editing the NET.CFG File Using an OS/2 Text Editor . . . . .	757
NET.CFG Options and Settings . . . . .	759
The NetWare for OS/2 Option . . . . .	759
The NetWare Requester Option . . . . .	764
Using NetWare Server for OS/2 SET Parameters . . . . .	766
Performance Tuning . . . . .	766
OS/2 Debugger. . . . .	766
Backup Support for NetWare Server for OS/2 . . . . .	767

## **C SFT III Management Tips**

Server Synchronization . . . . .	770
Detecting Server Synchronization Errors. . . . .	770
Handling Secondary Restarts Immediately After Synchronization . . . . .	770
Notifying Users of Server Synchronization . . . . .	770
Reducing the Time for Resynchronizing and Remirroring . . . . .	771
Responding to "Invalid Mirrored Server Initialization" Messages. . . . .	771
Responding to "Mirrored Server Engine Already Loaded" Messages . . . . .	772
Mirrored Server Link (MSL) . . . . .	772
Determining Appropriate MSL Cable Lengths . . . . .	772
Handling MSL Cable or MSL Board Failure . . . . .	772
Responding to MSL Communications Error Messages . . . . .	773
Responding to "MSL Deadlock Delivering Data" Messages . . . . .	773



Server Configuration (.NCF) Files . . . . .	773
Server Memory . . . . .	775
Adding Memory Without Bringing the MSEngine Down . . . . .	775
Responding to “Secondary Server Is Missing RAM” Messages . . . . .	776
Server Consoles . . . . .	778
Logging and Viewing All Console Messages . . . . .	778
Handling Lost Interrupt Alerts on the Console . . . . .	778
Responding to “Loader Cannot Find...” Messages . . . . .	779
Shortening the Console Prompt . . . . .	779
Server Hard Disks . . . . .	779
Controlling the Size of Log Files on Volume SYS: . . . . .	779
Handling Primary Hard Disk Failure . . . . .	780
Mounting a CD-ROM as a NetWare 4.11 SFT III Volume . . . . .	781
Notifying Users of Disk or Server Failure . . . . .	783
Recovering an Orphaned Partition . . . . .	783
Network Clients . . . . .	784
Finding a Server from an Ethernet Workstation . . . . .	784
Finding the SFT III Server First . . . . .	785
Handling DOS IPX Session Timeouts During Server Switchover . . . . .	785
Logging in ARCnet or Token Ring Clients Immediately After a Halt . . . . .	785
Responding to “LAN Driver Loopback Error Detected” Messages . . . . .	785
Turning Off the IPX Checksum Option for Token Ring . . . . .	785
Network Performance . . . . .	786
Handling Frequent Ups and Downs of the IPX Internet . . . . .	786
Responding to “IPX Network No Longer Returning Status” Messages . . . . .	787
Handling Primary Network Board Failure . . . . .	787
Troubleshooting . . . . .	788

## **D Creating Menus**

Creating, Converting, and Modifying Menu Files . . . . .	799
Getting Acquainted with NMENU . . . . .	800
NMENU Syntax . . . . .	800
What Menus Look Like . . . . .	800
What Makes Menus Work . . . . .	802
Planning Your Menus . . . . .	807
Using the NMENU Commands . . . . .	808
NMENU Organizational Commands and Options . . . . .	808
NMENU Control Commands and Options . . . . .	813
Creating a Menu File . . . . .	820
Example Menu Programs . . . . .	820
Making Menus Work . . . . .	823
Setting Up the User Environment . . . . .	823
Converting Old Menu Files . . . . .	825

**Trademarks**

Novell Trademarks . . . . . 829  
Third-Party Trademarks . . . . . 831

**Index**

# How to Use This Manual

*Supervising the Network* has two purposes: to help you set up your network after completing the installation procedure, and to help you manage your network after you have installed or upgraded servers to NetWare® 4.11.

This manual is to be used by network supervisors responsible for maintaining all or part of a NetWare 4.11 network.



To set up or maintain a network in the NetWare Enhanced Security configuration (the Class C2 evaluated configuration), you must supplement the information in this manual with the information in *NetWare Enhance Security Server*, *NetWare Enhanced Security Administration*, *Auditing the Network*, and *Security Features User Guide*.

The checklist in the following section explains the process of planning and setting up a network, and refers you to the manual containing the information and instructions you need to complete that step in the process.



In Novell® documentation, an asterisk denotes a trademarked name belonging to a third-party company. Novell trademarks are denoted with specific trademark symbols, such as ™.

## Checklist for Installing and Setting Up Your Network

To set up your NetWare 4.11 network, use the manuals in your NetWare 4.11 set in the order shown in the following checklist. (Chapter-only references refer to chapters within *this* manual.)



- Install NetWare 4.11. See *Installation* for instructions.
- Set up Novell Directory Services™ (NDS) objects, such as organizations, groups, and user accounts. Chapter 1, “Managing Novell Directory Services Objects,” on page 1 gives you information and procedures.

- ❑ Set up your file system and install network applications. Chapter 2, “Managing Directories, Files, and Applications,” on page 97 contains planning guidelines and instructions for creating directories and installing applications.
- ❑ Plan and create login scripts. Chapter 3, “Creating Login Scripts,” on page 169 explains the types of login scripts you can use and gives you instructions for setting them up.
- ❑ Set up printing. See *Print Services for information and instructions*.
- ❑ Set up workstations. See *NetWare Client for DOS and Windows User Guide* or *NetWare Client for OS/2 User Guide* for information and instructions.

## Managing Your Network

After setting up your network, use this manual to help you keep it updated and running efficiently.

Use this manual to help you perform such routine tasks as managing your Novell Directory database and its associated objects, maintaining your netware file system, and setting up servers and keeping your network running efficiently.

You can also use it as a reference for backing up and restoring network data, using optical storage devices to increase and manage your available disk space, and using the new NetWare DynaText\* online documentation.

To get an overview of how this manual can help you manage your network, review the tasks listed in the Table of Contents (see “Contents” on page iii).

# Command Syntax Conventions

This section explains the command syntax used in NetWare documentation. The following MAP example illustrates several syntax conventions:

```
MAP [P | NP] [option] drive:= [drive:|path]
```

After typing the command line, press <Enter> to execute the command.

Convention	Explanation
<b>Boldface</b> characters	Boldface characters indicate items that you type at the prompt, such as commands.
<i>Italicized</i> characters	Italicized characters indicate variables that you replace with information pertinent to your task.
... (ellipses)	Ellipses indicate that parameters, options, or settings can be repeated.
[ ]	An item enclosed in square brackets is optional. You can enter the command with or without the item.
[ [ ] ]	Items enclosed by nested square brackets are optional, but if you use the items within the innermost brackets, you must also use the items within the outer brackets.
	When items are separated by a delimiter bar, you can use either item, but not both.
{ }	Curly braces indicate that you must choose one of the enclosed options.

# User Comments

We are continually looking for ways to make our products and our documentation as easy to use as possible.

You can help us by sharing your comments and suggestions about how our documentation could be made more useful to you and about inaccuracies or information gaps it might contain.

Submit your comments by using the User Comments form provided or by writing to us directly at the following address:

Novell, Inc.  
Documentation Development PRV-C231  
122 East 1700 South  
Provo, UT 84606 USA  
[commentdoc@novell.com](mailto:commentdoc@novell.com)

We appreciate your comments.

# **Managing Novell Directory Services Objects**

This chapter helps you start managing your network after installing the NetWare® 4.11 operating system.

The first section in this chapter explains what objects exist in the Directory tree immediately after you have installed NetWare 4.11 or upgraded to NetWare 4.11.

The rest of the sections explain basic “getting started” tasks, such as

- ◆ Creating and managing objects, such as Users, Groups, Organizational Roles, and Profiles
- ◆ Searching for objects
- ◆ Moving, deleting, and renaming objects
- ◆ Changing properties of objects

You can use either the NetWare Administrator graphical utility or the NETADMIN text utility to do those tasks. Both methods are explained. In some cases, a third method is available, which is also explained.

# Default Objects and Rights for NetWare 4.11

Table 1-1 explains what objects exist in a Directory tree immediately after you install NetWare 4.11 or upgrade to NetWare 4.11, and what default rights those objects have.

**Table 1-1**  
**Default Objects and Rights in a Directory Tree**

Default Objects after NetWare 4.11 Installation	Default Objects after NetWare 4.11 Upgrade	Default Rights after NetWare 4.11 Installation or Upgrade
NetWare Server object for the server on which NetWare 4.11 was installed	NetWare Server object for the server you upgraded to NetWare 4.11	User object ADMIN has the Supervisor object right to the NetWare Server object, which means that User object ADMIN also has the Supervisor right to the root directory of the file system of all volumes attached to the server.
Volume object SYS	Volume object SYS for volume SYS: on the server you upgraded	The container object for Volume object SYS is granted Read and File Scan rights to the volume's SYS:PUBLIC directory. This means that when users are created, they can access utilities located in the SYS:PUBLIC directory.
Volume objects for any other volumes on the server's disk besides SYS: that you created during installation	Volume objects for every other volume besides SYS: on the server you upgraded	<p>[Root] is granted the Read property right to the Host Server Name and Host Resource properties on all Volume objects. This means that all objects in the Directory tree have access to the physical volume name and the physical server name.</p> <p>User object ADMIN has the Supervisor right to the root directory of the file systems on these volumes.</p>



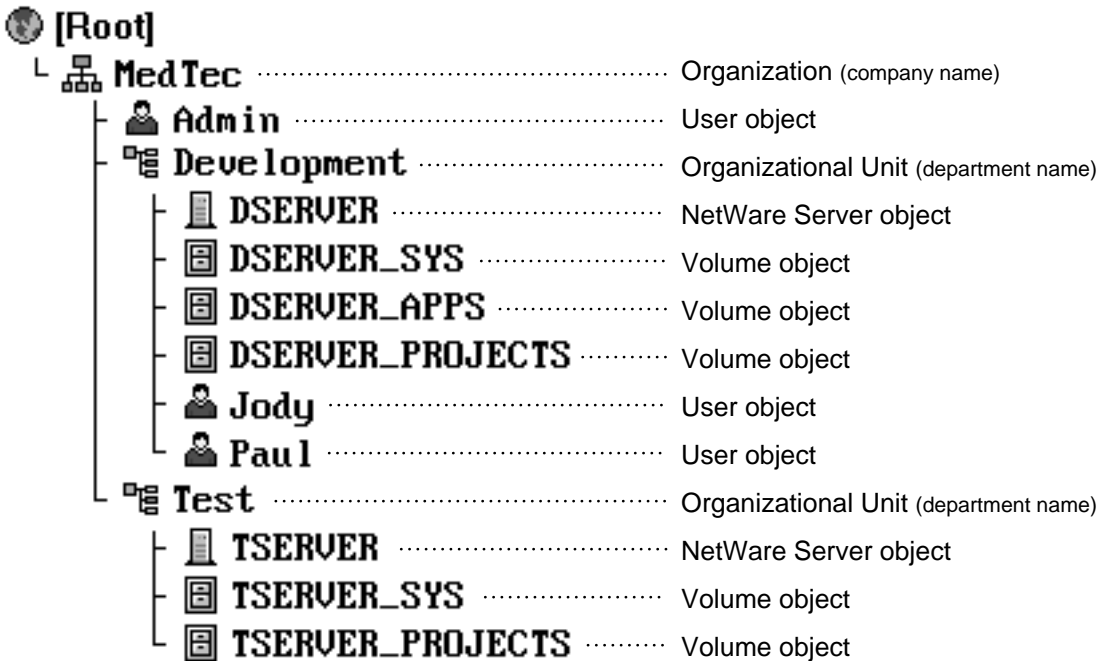
Table 1-1 *continued*

**Default Objects and Rights in a Directory Tree**

Default Objects after NetWare 4.11 Installation	Default Objects after NetWare 4.11 Upgrade	Default Rights after NetWare 4.11 Installation or Upgrade
<p>User object ADMIN</p> <p>When User object ADMIN is first created, by default it is placed in the Organization container object. This may not be the same context in which you installed the server.</p>	<p>User object ADMIN</p> <p>When User object ADMIN is first created, by default it is placed in the Organization container object. This may not be the same context in which you installed the server.</p> <p>All other objects that were on the server's bindery are placed in the same container as the server that was upgraded.</p>	<p>User object ADMIN receives a trustee assignment of Supervisor object right to the Root object of the Directory tree. This means that User object ADMIN has all rights to all the objects in the Directory tree.</p> <p>User object ADMIN also has the Supervisor object right to the NetWare Server object, which means that User object ADMIN has the Supervisor right to the root directory of the file system of all volumes attached to the server.</p> <p>[Public] has Browse object right at the root. This means that users who are attached to a Novell® Directory Services™ server, but who are not authenticated, can browse the tree.</p> <p>The network supervisor can remove [Public] browse rights so that users cannot do this.</p> <p>Users are granted all rights to their home directories, which are migrated when you migrate User objects.</p>

Figure 1-1 shows objects in a Directory tree after you have upgraded one server (DSERVER) and installed a NetWare 4.11 server (TSERVER).

Figure 1-1  
Example of a New Directory Tree



DSERVER was upgraded from NetWare 3.11 and placed in the context DEVELOPMENT.MEDTEC (that is, in Organizational Unit DEVELOPMENT, which is in Organization MEDTEC).

The volumes and users on the NetWare 3.11 server (DSERVER\_SYS, DSERVER\_APPS, DSERVER\_PROJECTS, JODY, and PAUL) were converted into Directory objects when the server was upgraded to NetWare 4.11.

TSERVER is a newly installed NetWare 4.11 server that was placed in the context TEST.MEDTEC (that is, in Organizational Unit TEST, which is in Organization MEDTEC). Volume object TSERVER\_SYS was created by default, and Volume object TSERVER\_PROJECTS was defined by the network supervisor during installation.

# Setting Up Administration Utilities

After installing client software on your workstation, set up the following administration utilities so that you can create and manage NDS objects in your Novell Directory tree:

- ◆ NetWare Administrator—a graphical utility that lets you create and manage NDS objects, set up printing and licensing services, and assign rights to the file system.
- ◆ NETADMIN—the DOS-based version of NetWare Administrator; NETADMIN lacks some of the functionality and enhancements that exist in NetWare Administrator.

To set up and run NETADMIN, or any DOS-based utility, map a search drive to SYS:PUBLIC and type the utility name at the DOS command line.

- ◆ NDS Manager—a graphical utility that lets you create and manage NDS partitions and replicas, perform diagnostics on your Directory tree, repair NDS synchronization errors, and update the version of NDS on NetWare servers in your network.

For information on setting up and using NDS Manager, see “Setting Up NDS Manager” on page 297.

## Setting up NetWare Administrator on a Windows 3.1 Workstation



### Prerequisites

- A workstation cabled to the network and running Windows\* 3.1
- 1.2 MB of free disk space on the workstation
- A drive mapping to SYS:PUBLIC on your preferred server
- Authentication to a Novell Directory tree

## Procedure

1. In Program Manager, choose the “NetWare Tools” program group or another program group you want to start NetWare Administrator from.
2. From the Program Manager “File” menu, choose “New.”
3. Select “Program Item” and choose “OK.”
4. Enter “NWADMIN” in the “Description” field and press <Tab>.
5. Choose “Browse.”
6. From the “Drives” drop-down list, select the drive that points to SYS:PUBLIC.
7. From the list under “File Name,” select NWADMN3X.EXE and choose “OK.”

The path to the executable file is placed in the “Command Line” text box.

8. Choose “OK” again, and then choose “Yes.”

NetWare Administrator is created as a program item icon in the group you selected.

You can now use the NetWare Administrator graphical utility to manage your Directory tree.

## Additional Information

For more information about	See
Installing Windows workstation software	<i>NetWare Client for DOS and Windows User Guide</i>
Using the NetWare Administrator utility	“NetWare Administrator” in <i>Utilities Reference</i>
Logging in	“LOGIN” in <i>Utilities Reference</i>

# Setting up NetWare Administrator on a Windows 95 Workstation



## Prerequisites

- A workstation cabled to the network and running Windows 95\* and Client 32™
- 1.2 MB of free disk space on the workstation
- A drive mapping to SYS:PUBLIC on your preferred server
- Authentication to a Novell Directory tree



## Procedure

1. **From the Windows 95 desktop, right-click and choose “New.”**
2. **Choose “Shortcut.”**
3. **Choose “Browse.”**
4. **From the Browser, locate the drive that points to SYS:PUBLIC and choose NWADMN95.EXE.**
5. **Choose “Open.”**
6. **Choose “Finish.”**

NetWare Administrator is created as a shortcut icon on your desktop.

You can now use the NetWare Administrator graphical utility to manage your Directory tree.

## Additional Information

For more information about	See
Installing Windows 95 workstation software	<i>IntranetWare Client for Windows 95 Supervisor Guide</i>
Using the NetWare Administrator utility	“NetWare Administrator” in <i>Utilities Reference</i>

---

For more information about	See
Logging in	"LOGIN" in <i>Utilities Reference</i>

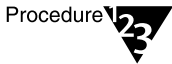
---

## Setting up NetWare Administrator on an OS/2 Workstation



### Prerequisites

- A workstation cabled to the network and running OS/2\* v2.x (or later versions) and WIN-OS/2.
- At least one NetWare 4.11 server installed
- A drive mapping to SYS:PUBLIC on your preferred server
- Authentication to a Novell Directory tree



### Procedure

1. In Program Manager, choose the "NetWare Tools" program group or another program group you want to start NetWare Administrator from.
2. From the Program Manager "File" menu, choose "New."
3. Select "Program Item" and choose "OK."
4. Enter "NWADMIN" in the "Description" field and press <Tab>.
5. Choose "Browse."
6. From the "Drives" drop-down list, select the drive that points to SYS:PUBLIC.
7. From the list under "File Name," select NWADMN3X.EXE and choose "OK."

The path to the executable file is placed in the "Command Line" text box.

**8. Choose “OK” again, and then choose “Yes.”**

NetWare Administrator is created as a program item icon in the group you selected.

You can now use the NetWare Administrator graphical utility to manage your Directory tree.

**Additional Information**

<b>For more information about</b>	<b>See</b>
Installing OS/2 workstation software	<i>NetWare Client for OS/2 User Guide</i>
Using the NetWare Administrator utility	“NetWare Administrator” in <i>Utilities Reference</i>
Logging in	“LOGIN” in <i>Utilities Reference</i>

## **Rights Needed to Create and Manage Objects**

As User object ADMIN, you have all rights to all objects on the Directory tree. However, to allow various parts of the Directory tree to be managed by other users, you need to give those users the rights necessary for them to manage their sections of the tree.

When you give an object, such as a User, rights to another object, such as a container, you have made a *trustee assignment*. That User is now a *trustee* of that container. An object with a trustee assignment to another object is a *trustee* of that object.

Each object contains a list of trustee assignments called a *trustee list*. This list tells who can access that object. An object’s trustee list is stored in its Access Control List (ACL) property.

Four kinds of rights exist in NetWare 4.11:

- ◆ **Object rights:** Control what a trustee can do with an object. These rights control the object as a single piece in the Directory tree, but don't allow access to information stored within that object (unless the Supervisor object right is granted).
- ◆ **Property rights:** Control a trustee's access to information stored within the object—that is, the information stored in the object's properties. Each object has several properties.
- ◆ **Directory rights:** Control what a trustee can do with a directory. Directory rights also apply to files in the directory only if file rights aren't granted and the file's Inherited Rights Filter doesn't block the directory rights.
- ◆ **File rights:** Control what a trustee can do with a file.

In previous versions of NetWare, you could assign directory and file rights. In NetWare 4.11, you can also assign rights to an object and to properties belonging to an object.

This section covers only object rights and property rights.

Directory rights and file rights apply only to the file system. For a discussion of these rights, see “Loading Operating Systems and Applications onto the Network” on page 109.

Object and property rights are assigned separately so that you can control access to the pieces of information (or properties) contained in the object.

Any object to which you grant sufficient rights can make trustee assignments, using the NetWare Administrator or NETADMIN utility.



# Object Rights

Object rights control what trustees can do with the object that they are trustees of. Object rights control the object as a single piece in the Directory tree, but do not allow the trustee to access information stored in that object's properties (unless the Supervisor object right is granted).

Table 1-2 lists and describes the object rights that you can assign to a trustee.

**Table 1-2**  
**Object Rights**

Right	Description
Supervisor	<p>Gives you all rights to the object and to all its properties. However, the Supervisor object right <i>can</i> be blocked by the Inherited Rights Filter (IRF) below the object where the Supervisor right is granted.</p> <p>(An IRF is a list of rights that can be created for any object. It controls the rights that a trustee can inherit from container objects.)</p>
Browse	<p>Allows you to see the object in the Directory tree. Also, when you perform a search for a value that matches the object, the Browse right to an object allows that object to be listed.</p>
Create	<p>Allows you to create a new object within a container object in the Directory tree. This right applies only to container objects because leaf objects cannot contain other objects.</p>
Delete	<p>Allows you to delete an object from the Directory tree. However, you cannot delete a container object unless all the objects in the container are deleted first. See "Moving Container Objects Using NETADMIN" on page 76, or "Moving Container Objects Using NetWare Administrator" on page 74.</p>
Rename	<p>Allows you to change the name of the object, in effect changing the naming property. This changes what the object is called when it's a part of complete names. See "Renaming Leaf and Container Objects" on page 83.</p>

## Property Rights

While object rights allow you to see the object, delete the object, create a new object, etc., they do not allow you to see the information stored in the object's properties.

To read the information in an object's properties, you must have the correct property rights. Property rights control access to each property in an object.

For example, if you include a private telephone number as a property for a User object, you can use property rights to prevent anyone else from seeing that telephone number. At the same time, you can allow other properties, such as Address or Fax Number, to be viewed.

Table 1-3 lists and describes property rights that you can assign to a trustee

**Table 1-3**  
**Property Rights**

Right	Description
Supervisor	Gives you all rights to the property. You can block the Supervisor property right with an Inherited Rights Filter. See "Security" in <i>Concepts</i> .
Compare	Allows you to compare any value to an existing value of the property. The comparison can return True or False, but cannot give the value of the property.
Read	Allows you to read the values of the property. This right includes the Compare right; that is, if the Read right is given, Compare operations are also allowed.
Write	Allows you to add, change, or remove any values of the property. The Write right includes the Add or Delete Self right  The Write right to the ACL property is the same as giving the Supervisor right to the object.

**Table 1-3**  
**Property Rights** *continued*

Right	Description
Add or Delete Self	Allows you to add or remove yourself as a value of the property, but you cannot change any other values of the property. This right is only used for properties where your User object can be listed as a value, such as group membership lists or mailing lists. The Write right includes the Add or Delete Self right.

See the following references for more detailed information.

#### **Additional Information**

For more information about	See
Access Control List	"Access Control List" in <i>Concepts</i>
Container and leaf objects	"Object" in <i>Concepts</i>
Trustees and rights	"Security" in <i>Concepts</i>

## **Managing Trustee Assignments to Objects**

An object granted rights to work with another object is called a *trustee* of the object.

Through *trustee assignments*, you determine what level of rights you want trustees to have on the objects they are assigned to.

For example, to make user KSMITH a trustee of Organizational Unit **MARKETING**, go to the Organizational Unit **MARKETING** and add KSMITH as a trustee, giving KSMITH whatever object and property rights you think are sufficient.

KSMITH's trustee assignment to **MARKETING** overrides any other rights that KSMITH may have inherited or received through security equivalence.

You can manage trustee assignments to objects using either the NetWare Administrator graphical utility or the NETADMIN text utility. Both procedures are documented in this section.

For more information about	See
Inherited Rights Filter	"Inherited Rights Filter" in <i>Concepts</i>
Rights	"Rights" in <i>Concepts</i>
Security	"Security" in <i>Concepts</i>
Trustees	"Trustee" in <i>Concepts</i>
Using the NetWare Administrator utility	"NetWare Administrator" in <i>Utilities Reference</i>

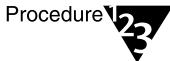
## Using NetWare Administrator to Manage Trustee Assignments



Checklist

### Prerequisites

- A 386 or 486 workstation running NetWare Administrator
- The Supervisor object right to the object to which trustees are to be assigned



Procedure

### Procedure

1. From the MS Windows Program Manager or the OS/2 desktop, choose the "NetWare Administrator" icon.
2. Select the object you want to assign trustees to.
3. Click once on the right button of your mouse and choose "Trustees of this Object," or, from the "Object" menu, choose "Trustees of this Object."

All the current trustees of this object are listed in the "Trustees" box.

From the “Trustees” dialog, you can

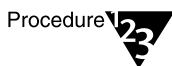
- ◆ View or change a trustee’s effective rights to this object
  - ◆ Add a trustee to this object
  - ◆ Delete a trustee from this object
  - ◆ Change the object rights of a trustee
  - ◆ Change the property rights of a trustee
  - ◆ View or change the Inherited Rights Filter (IRF) of this object
4. **For instructions on completing any of the above procedures, press the “Help” button and then select one of the procedures from the list.**

## Using NETADMIN to Manage Trustee Assignments



### Prerequisites

- A workstation running DOS 3.30 or later and the NETADMIN utility
- The Supervisor object right to the object to which trustees are to be assigned



### Procedure

1. **At the DOS prompt, type**  
  
`NETADMIN <Enter>`  
  
For information on moving around in NETADMIN and selecting objects, press <F1> after starting the utility.
2. **Choose “Manage Objects” from the “NETADMIN Options” menu.**
3. **Browse the Directory tree until you see the object you want to assign trustees to.**  
  
Use the instructions at the bottom of the screen to browse the directory. Press <F1> if you need help.
4. **When the desired object appears in the “Object, Class ” list, select it and press <F10>.**

**5. Select “View or Edit the Trustees of This Object.”**

From the “Trustees of This Object” menu you can

- ◆ Set the “Inherited Rights Filter” (IRF), which affects all trustees that are not explicitly assigned to this object.
- ◆ Add or change trustee assignments (which override the IRF)
- ◆ View the “Effective Rights” for a trustee

**6. From the “Trustees of This Object” menu, select one of the options.**

**7. For instructions on completing a procedure, press <F1>.**

## Creating Container Objects

You can create container objects by using either the NetWare Administrator graphical utility or the NETADMIN text utility. Each of these methods is explained in this section.

Considerations for naming container objects and suggestions for creating searchable objects are also covered.

### Types of Container Objects

The kinds of container objects you can create are Country, Organization, and Organizational Unit. The top object, called Root, is created by default and is placed at the top of the Directory tree when NetWare 4.11 is installed.



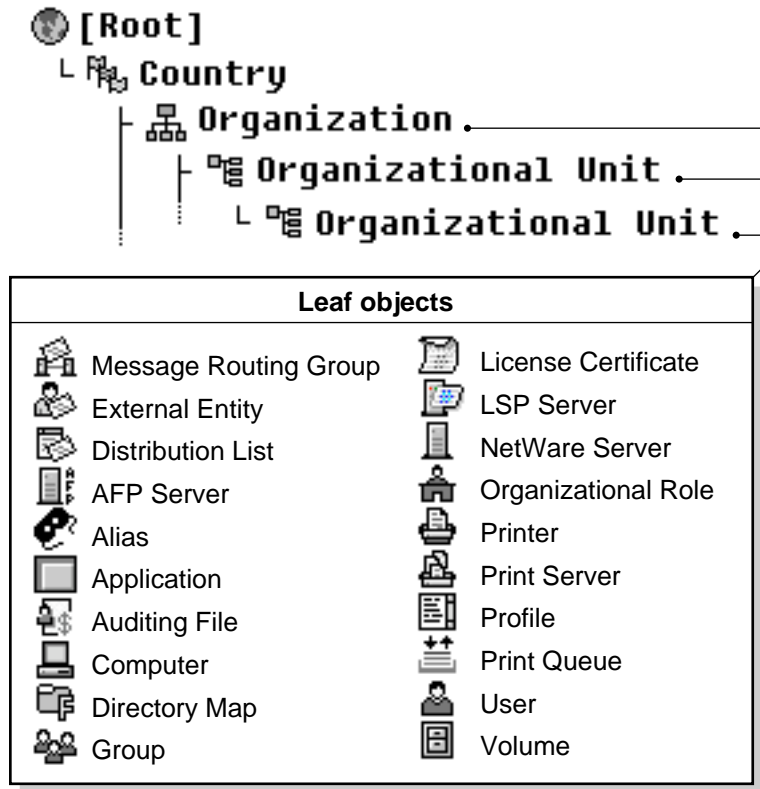
A fourth type of container object, Licensed Product, is created automatically when you install applications enabled for NetWare Licensing Services (NLS) technology. For more information, see Chapter 10, “Managing NetWare Licensing Services,” on page 683.

Container objects form the top levels of the Directory tree. Use them to manage and organize the Directory by relating groups of objects, both container objects and leaf objects.

For more information about planning the top levels of your Directory tree, see “Planning the Directory Tree Structure” in Chapter 3 of *Guide to NetWare 4 Networks*.

Figure 1-2 illustrates the hierarchy of container objects and leaf objects in Novell Directory Services. (The icons represent the leaf objects as they appear in the NetWare Administrator graphical utility.)

Figure 1-2  
Hierarchy of  
Objects



The first three leaf objects in the figure—Message Routing Group, External Entity, and Distribution List—are NetWare Message Handling Service™ (NetWare MHS) objects. They appear in NetWare Administrator only if you have installed NetWare MHS™ Services on your NetWare server.

You can create leaf objects only under the Organization, Organizational Unit, and (in specific cases) Licensed Product container objects.

Table 1-4 describes each type of container object you can create and when to use it.

**Table 1-4**  
**Container Objects You Can Create**

Container Object	Description	When to Use It
Country	<p>Designates the countries where your network resides and organizes other objects within the country.</p> <p>You must always include the name type of the object in complete names when you include the Country container object in your Directory tree. Even when you refer to objects located in the same container object, you must designate the name type (CN, OU, or O) of the object.</p>	<p>This object is optional. You do not have to create a Country object.</p> <p>If you choose to create a Country object, you can use it to represent the country where your organization headquarters reside or, if you have a multinational network, to represent each country that is a part of your network.</p> <p>You can create a Country container object only under the Root object.</p>
Organization	<p>Allows you to organize other objects in the Directory, to set defaults in a login script, and to create a user template for User objects you create in this container.</p> <p>For example, you can use an Organization object to designate a corporation.</p>	<p>The Organization container object is mandatory. The Directory tree must contain at least one.</p> <p>You can create an Organization object only under the Root or Country object.</p>
Organizational Unit	<p>Allows you to organize leaf objects in the Directory tree, to set defaults in a login script, and to create a user template for User objects you create in this container.</p>	<p>You can use an Organizational Unit object to designate a division, a business unit, or a project team.</p> <p>You can create multiple levels of Organizational Units.</p> <p>You can create Organizational Units in Organization objects and in other Organizational Unit objects.</p>



Table 1-4 *continued*

## Container Objects You Can Create

Container Object	Description	When to Use It
Licensed Product	Licensed Product container objects are created automatically when you install a license certificate or create a metering certificate using NetWare Licensing Services (NLS) technology.	When an NLS-enabled application is installed, it should add a Licensed Product container object to the Novell Directory database and a License Certificate leaf object to that container.

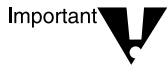
## Naming Container Objects

Try to keep container object names short and simple. This makes it easier for users to change context and to remember their own context.

The following rules apply to most objects. For specific rules about naming leaf objects, see “Naming Leaf Objects” on page 33.

### Object Naming Rules

- ◆ The name must be unique in the branch (container) of the Directory tree where the object is located.
- ◆ The object name can be up to 64 characters in length.
- ◆ You can use any special characters. But if the object needs to be accessed from a client running a version of NetWare earlier than NetWare 4™, you should avoid using special characters. (For a list of these characters, see “Object Name Restrictions for Bindery Services” on page 20.)
- ◆ You can enter object names in either upper or lowercase. Object names are displayed with uppercase and lowercase letters as they were first entered, but they are not case sensitive. Therefore, “ManagerProfile” and “MANAGERPROFILE” are considered to be identical names.
- ◆ You can use both spaces and underscores, but they are both displayed as spaces. Therefore, “Manager\_Profile” and “Manager Profile” are considered to be identical names.



- ◆ Country objects can have only a two-character name.

If you anticipate managing objects created from different code pages, you must limit object names and properties to those characters common to all the applicable code tables.

Nondisplayable Unicode\* characters for your code page are represented by an ASCII 3 character (a “heart” symbol). For more information, see “Unicode” in *Concepts*.

## Object Name Restrictions for Bindery Services

When you create objects to be accessed from a client running a version of NetWare earlier than NetWare 4, the names of the objects must follow bindery naming rules or the non-NetWare 4.11 client will not recognize them. Object names in bindery services are interpreted as the following:

- ◆ Spaces in object names are replaced by underscores.
- ◆ Object names longer than 47 characters are cut off after the 47th character.

You cannot use the following characters in an object name that must be accessed from a client running a version of NetWare earlier than NetWare 4:

- / Slash
- \ Backslash
- : Colon
- , Comma
- \* Asterisk
- ? Question mark

## Creating Searchable Container Objects

When you create a container object, you can enter various types of information about that object into its properties, such as location and telephone number. If you enter data into the containers' properties in a consistent format, it is easier to search the Directory database for a particular type of information.

Many container object properties are optional; you are not required to enter information about the property in order to create the object. However, information in objects' properties can help you track and manage container objects.

After you have created container objects, you can use the NetWare Administrator, NETADMIN, or NLIST utility to search for and list these objects. You can also search for their various properties.

## Creating Container Objects Using INSTALL

When you install NetWare 4.11 on a server, you are required to type a context (the pathname from the container object to the Root object) in which the NetWare Server object is placed.

If you create a new context, several events happen by default:

- ◆ An Organization or Organizational Unit container object is created, depending on the context you create.
- ◆ Bindery services are set for that container object, so that the server you installed in the container object is running bindery services.
- ◆ A read/write replica of the Directory partition that the container object is in is stored on the server that you just installed.

For more information on how to create container objects using the installation process, see Chapter 2, "Simple Installation," or Chapter 3, "Custom Installation," of *Installation*.

## Creating Container Objects Using NetWare Administrator

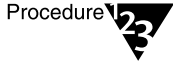


### Prerequisites

- A 386 or 486 workstation running NetWare Administrator

- The Create object right to the container that will contain the new container object

### Procedure



1. **From the MS Windows Program Manager or the OS/2 desktop, choose the “NetWare Administrator” icon.**
2. **Select the object that will contain the new container object.**  
  
For information on moving around in the browser and choosing objects, press <F1>.
3. **Choose “Create” from the “Object” menu.**
4. **Select the new container object class that you want from the “New Object” dialog.**

If the container object class you want to create does not appear under “New Object,” you cannot create that object in the selected container. Choose “Cancel” to return to the browser; then select a different container type.

5. **Choose “OK.”**  
  
The “Create Object” dialog appears.
6. **Type a name for the object in the box provided.**
7. **(Optional) Select “Define Additional Properties.”**

Select this option if you want to enter more information for the new container object.

Examples of additional properties are Login Script, Intruder Detection, Postal Address, and See Also. The Login Script and Intruder Limit apply to User objects in the new container object.

**8. (Optional) Select “Define User Defaults.”**

Select this option if you want to use the same default information in the new container as was present in the parent container. This default information is used whenever you create a new user.

The user default information for each container is actually stored in a User object named USER\_TEMPLATE.

**9. Choose “Create.”**

**10. (Optional) Choose “Yes” if you want to inherit user template properties from the parent container, or “No” if you want to define a new user template.**

**11. (Optional) Add information to the object dialog pages.**

If you chose “Define Additional Properties,” add the information now. Press <F1> to get help on each field.

**12. Choose “OK” to save the properties you have just entered in the dialog pages.**

**Additional Information**

For more information about	See
Objects	“Object” in <i>Concepts</i>
Rights	“Rights” in <i>Concepts</i>
User templates	“Managing User Templates” on page 60
Using the NetWare Administrator utility	“NetWare Administrator” in <i>Utilities Reference</i>
Using object dialog pages in NetWare Administrator	“NetWare Administrator” in <i>Utilities Reference</i>

## Creating Container Objects Using NETADMIN

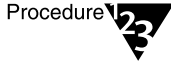
### Prerequisites



- A workstation running DOS 3.30 or later

- The Create object right to the object that will contain the new container object

### Procedure



**1. At the DOS prompt, type**

`NETADMIN <Enter>`

For information on moving around in NETADMIN and selecting objects, press <F1> after starting the utility.

**2. Choose “Manage Objects” from the “NETADMIN Options” menu.**

**3. Select the container object that will contain the new container object.**

The objects in the selected container are listed.

To see if you’re in the right context, look at the title bar on the screen. Press <F1> if you need help.

**4. Press <Insert>.**

**5. Select the container object class that you want to create from the “Select an Object Class” screen.**

If the container object class you want to create does not appear, you cannot create that object in the selected container. Press <Esc> to return to the browser; then select a different container type.

**6. Type the new container object name.**

**7. Enter a Mailbox Location and press <Enter>.**



If you are creating a Country object, you are not prompted to define a Mailbox Location or create a user template.

**8. If you want to create a user template to be applied to new User objects created in this container, type “Y” and press <Enter>.**

A user template contains default information that you can apply to users that you create to give them default property values.

The user template is actually a User object named USER\_TEMPLATE.

If you do not want to create a user template, type “N” and press <Enter>.

**9. Press <F10> to save the information.**

**10. If you want to create another container object, choose “Yes.” If you do not, choose “No” and then press <Enter>.**

If you chose “Yes,” you are prompted to type the new container object name. Repeat Steps 6 through 9, and then continue with Step 12.

If you chose No, then the container object is displayed in the Directory tree. Continue with Step 12.

**11. To edit this object, press <F10>.**

A menu appears from which you can choose to view or edit properties of this object and make trustee assignments to this object and to files and directories.

**12. Choose an option from the “Actions” menu and add any necessary information.**

**13. To exit, press <Esc> until you return to the “NETADMIN Options” menu.**

### Additional Information





















For more information about	See
Objects	“Object” in <i>Concepts</i>
Object properties	“Property” in <i>Concepts</i>
User templates	“Managing User Templates” on page 60
Using the NETADMIN utility	“NETADMIN” in <i>Utilities Reference</i>

# Creating Leaf Objects

Leaf objects represent network resources, such as users, computers, printers, applications and lists. They do not contain any other objects.

You create leaf objects within a container object. Figure 1-3 lists the leaf objects you can create. (The icons represent the leaf objects as they appear in the NetWare Administrator graphical utility.)

Figure 1-3  
Leaf Objects You  
Can Create

Leaf objects	
 Message Routing Group	 License Certificate
 External Entity	 LSP Server
 Distribution List	 NetWare Server
 AFP Server	 Organizational Role
 Alias	 Printer
 Application	 Print Server
 Auditing File	 Profile
 Computer	 Print Queue
 Directory Map	 User
 Group	 Volume



The first three leaf objects in the figure—Message Routing Group, External Entity, and Distribution List—are NetWare MHS Services objects. They appear in NetWare Administrator only if you have installed NetWare MHS Services on your NetWare server.



# How to Use Leaf Objects

Table 1-5 describes each leaf object you can create and when to use it.

**Table 1-5**  
**Leaf Objects You Can Create**

Leaf Object	Description	When to Use
AFP Server	Represents an AppleTalk* Filing Protocol-based server that is operating as a node on your NetWare network (and possibly also acting as a NetWare router to, and the AppleTalk* server for, several Apple* Macintosh* workstations).	<p>Create this object when you have an AFP server that you need to represent on the network. Use it to store information about this server, such as its description, location, and network address.</p> <p>This object has no effect on the operation of the network; it only stores information about the AFP server.</p>
Alias	<p>Points to another object in the Directory tree and makes it appear as if the object that it points to actually exists in the Directory tree where the Alias object is.</p> <p>Although an object appears both where it was actually created and where an Alias referring to it was created, only one copy of the object really exists.</p> <p>If you delete or rename an Alias, the Alias itself (not the object it is pointing to) is deleted or renamed.</p>	<p>Use this object to allow access to an object that is in another context.</p> <p>For example, you can use an Alias to represent a resource, such as a special printer, that most users in the tree need to access.</p> <p>Also, when you move or rename a container object in a Directory tree, you have the option of creating an alias in place of the moved or renamed object. If you select this option, NetWare Administrator automatically creates the alias for you and assigns it the same name as the original object.</p> <p>Creating an alias in place of a moved or renamed container object allows users to continue logging into the network and to see the container object (and the objects it contains) in its original Directory location</p>

Table 1-5 *continued*

### Leaf Objects You Can Create

Leaf Object	Description	When to Use
Application	<p>NetWare Application Manager allows network supervisors to manage network applications as Application objects in the Novell Directory tree.</p> <p>NetWare Application Manager displays icons for all available applications in a window, and lets the user double click on an icon to launch an application. Users don't need to worry about drive mappings, paths, or rights.</p> <p>The network supervisor can manage applications at the container, Group, or User object level.</p>	<p>Application objects allow you to manage the network more efficiently, saving time and headaches administering applications.</p> <p>Application objects simplify administrative tasks such as assigning rights, customizing login scripts, and supporting applications.</p>
Auditing File	<p>The Auditing File Object (AFO) is the Novell Directory Services data structure used to manage an audit trail's configuration and access rights.</p>	<p>The audit utility (such as AUDITCON) creates the AFO when you enable auditing. The server then checks for access rights each time a user attempts to access the audit trail.</p>
Computer	<p>Represents a nonsERVER computer on the network, such as a workstation or a router.</p>	<p>Use this object to store information about a nonsERVER computer, such as its network address, or serial number, or the person the computer is assigned to.</p> <p>This object has no effect on the operation of the network; it only stores information about the computer.</p>

Table 1-5 *continued*

## Leaf Objects You Can Create

Leaf Object	Description	When to Use
Directory Map	<p>Represents a particular directory in the file system. Directory Map objects can be especially useful in login scripts by pointing to directories that contain applications or other frequently used files.</p> <p>For example, if you have a directory that contains DOS 5.0, you will probably map a search drive to that directory in any login scripts you create. Later, if you upgrade to DOS 6.0 and rename the directory, you would have to change the mapping in every login script where that search mapping appears.</p> <p>With a Directory Map object, you only change the information in that one object.</p>	<p>Use this object to avoid making changes to many login scripts when the location of applications changes; instead, you change only the Directory Map object.</p> <p>For more information on Directory Map objects, see “Loading Operating Systems and Applications onto the Network” on page 109.</p>
Distribution List	<p>Represents a list of mail recipients.</p>	<p>Use this object to simplify sending mail to recipients.</p> <p>For example, you could create a Distribution List object called Recreation Committee. Anyone wanting to send a message to all the members in the Recreation Committee can simply address the message to Recreation Committee, rather to each member.</p>
External Entity	<p>Represents a nonnative NDS (Novell Directory Services) object that is imported into NDS or registered in NDS.</p> <p>NetWare MHS Services uses External Entity objects to represent users from non-NDS directories to provide an integrated address book for sending mail.</p>	<p>If your messaging environment contains non-MHS servers, such as SMTP hosts, SNADS nodes, or X.400 MTAs, you might choose to add users and lists at these servers to your Novell Directory database as External Entities.</p> <p>Adding these objects to the database as External Entities adds them to the address books of your messaging applications. When addressing messages, local users can choose non-MHS users and lists from a directory list.</p>

Table 1-5 *continued*

**Leaf Objects You Can Create**

Leaf Object	Description	When to Use
Group	Assigns a name to a list of User objects that can be located anywhere in the Directory tree.	Create a Group when you have many User objects that need the same trustee assignments. Rather than making many trustee assignments, you make just one trustee assignment to all the users who belong to the group, by making the trustee assignment to the Group object itself.
License Certificate	Used with NetWare Licensing Services (NLS) technology to install product license certificates as objects in the Novell Directory database.	License Certificate objects are added to the Licensed Product container when an NLS-aware application is installed.
LSP Server	<p>When you register an LSP (License Service Provider) with NDS, an LSP Server object is created, by default, in the same context as the NCP Server object on which it is loaded. The LSP Server object can be relocated to another context in the Directory.</p> <p>An LSP Server object appears only if you load the NLS (NetWare Licensing Services) NLM program with an <code>-r</code> option.</p>	<p>A client-specific component packages the request and submits it to the nearest connected LSP.</p> <p>If the client is not connected to an LSP, the client checks the Novell Directory database, searching up the Directory tree for an LSP Server object.</p>
Message Routing Group	Represents a group of messaging servers that can transfer messages directly with each other.	Create a Message Routing Group when you have two or more messaging servers that need to communicate with each other.
Messaging Server	Represents a messaging server that resides on a NetWare server. A Messaging Server object is automatically created in the NDS tree when you install NetWare MHS Services on a NetWare server.	Create a Messaging Server (by installing NetWare MHS Services on a NetWare server) when you need a server to handle messaging between users and groups on the network.

Table 1-5 *continued*

**Leaf Objects You Can Create**

Leaf Object	Description	When to Use
NetWare Server	<p>Represents a server running NetWare on your network.</p> <p>Store information about the server in the NetWare Server object's properties, such as the server's address, the physical location of the server, and what services it provides.</p> <p>In addition to storing information about the NetWare server, the NetWare Server object affects the network in that it is referred to by several other objects.</p>	<p>Use the NetWare Server object to tie the physical server on the network to the Directory tree. Without this object, you cannot access file systems that are on that server's volumes.</p> <p>If you have a non-NetWare 4.11 server, you must create this object to be able to access those non-NetWare 4.11 volumes. When you create a NetWare Server object for a non-NetWare 4.11 server, the non-NetWare 4.11 server must be running.</p>
Organizational Role	<p>Defines a position or role within an organization.</p>	<p>Create an Organizational Role object so that you can assign rights to a particular position rather than to the person who may occupy that position. The occupant may change frequently, but the responsibilities of that position do not.</p> <p>You can assign any user to be an occupant of the Organizational Role object because every occupant receives the same rights that you granted to the Organizational Role object.</p>
Print Queue	<p>Represents a print queue on the network.</p>	<p>You must create a Print Queue object for every print queue on the network.</p> <p>This object cannot be created with NETADMIN.</p> <p>See <i>Print Services</i> for more information.</p>
Print Server	<p>Represents a network print server.</p>	<p>You must create a Print Server object for every print server on the network.</p> <p>This object cannot be created with NETADMIN.</p> <p>See <i>Print Services</i> for more information.</p>

Table 1-5 *continued*

**Leaf Objects You Can Create**

Leaf Object	Description	When to Use
Printer	Represents a physical printing device on the network.	<p>You must create a Printer object for every printer on the network.</p> <p>This object cannot be created with NETADMIN.</p> <p>See <i>Print Services</i> for more information.</p>
Profile	<p>Contains a profile script (login script). When the Profile object is listed as a User object's property, the Profile object's login script is executed when that User object logs in. The Profile login script executes after the system login script and before the user login script.</p>	<p>Create a Profile object for a set of users who need to share common login script commands but who are not located in the same container in the Directory tree, or who are a subset of users in the same container.</p>
User	<p>Represents a person who uses your network.</p> <p>In the User object properties, you can set login restrictions, intruder detection limits, password and password restrictions, security equivalences, etc.</p>	<p>You must create a User object for every user who needs to log in to the network. When you create a User object, you can create a home directory for that user who will have default rights to that home directory. When you create User objects, you can also choose to apply a user template to the user that provides default property values.</p> <p>For users who have NetWare 4.11 workstations, you can create the User objects anywhere in the Directory tree, but the users must know their context in order to log in. You should create User objects in the container where the users will typically log in.</p> <p>For users who have non-NetWare 4.11 workstations, you must create the User objects in the container at which the bindery services context is set for the server that they need to log in to. (Bindery services is set by default for every NetWare 4.11 server that is installed.) Non-NetWare 4.11 users do not need to know their context because they log in to the server rather than to the Directory tree.</p>

Table 1-5 *continued*

## Leaf Objects You Can Create

Leaf Object	Description	When to Use
Volume	<p>Represents a physical volume on the network.</p> <p>In the Volume object's properties, you can enter identification information, such as the Host server, volume location, etc. You can also set restrictions for use of the volume, such as space limits for users.</p>	<p>You can create a Volume object for every physical volume on the network. (During installation of NetWare 4.11 on a server, Volume objects are created for every physical volume on that server.)</p> <p>When you create a Volume object, you are prompted for the server name and the volume name on the server. That information is placed in the Volume object's properties.</p> <p>You can use the Volume object to display information about the directories and files on that volume.</p>

## Naming Leaf Objects

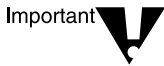
The object naming rules described in the next section apply to most objects. Special rules applying to NetWare Server objects and objects viewed through bindery services are described in separate sections. For rules about naming container objects, see "Naming Container Objects" on page 19.

### Object Naming Rules

- ◆ The name must be unique in the branch (container) of the Directory tree where the object is located.
- ◆ The object name can be up to 64 characters in length.
- ◆ You can use any special characters. But if the object needs to be accessed from a client running a version of NetWare earlier than NetWare 4, you should avoid using special characters. (For a list of these characters, see "Object Name Restrictions for Bindery Services" on page 20.)

- ◆ You can enter object names in either upper or lowercase. Object names are displayed with uppercase and lowercase letters as they were first entered, but they are not case sensitive. Therefore, “ManagerProfile” and “MANAGERPROFILE” are considered to be identical names.
- ◆ You can use both spaces and underscores, but they are both displayed as spaces. Therefore, “Manager\_Profile” and “Manager Profile” are considered to be identical names.

(If you use a space in a name, you must place quote marks around that text string whenever you use a command line utility that includes that text string.)



If you anticipate managing objects created from different code pages, you must limit object names and properties to those characters common to all the applicable code tables.

Nondisplayable Unicode characters for your code page are represented by an ASCII 3 character (a “heart” symbol). For more information, see “Unicode” in *Concepts*.

## Object Name Restrictions for Bindery Services

When you create objects to be accessed from a client running a version of NetWare earlier than NetWare 4, the names of the objects must follow bindery naming rules or the pre-NetWare 4 client does not recognize them. Object names in bindery services are interpreted as the following:

- ◆ Spaces in object names are replaced by underscores.
- ◆ Object names longer than 47 characters are cut off after the 47th character.

You cannot use the following characters in an object name that must be accessed from a client running a version of NetWare earlier than NetWare 4:

- / Slash
- \ Backslash
- : Colon
- , Comma
- \* Asterisk
- ? Question mark



## Naming Restrictions for NetWare Server Objects

The first NetWare Server object for a NetWare 4.11 server must be created with INSTALL. The object is given the same name as the physical server. Rules for naming physical servers are in the <F1> Help of INSTALL.

If you create a NetWare Server object for a non-NetWare 4.11 server, you must use the physical server name as well, because Novell Directory Services must search for the server on the network to verify its existence.

For example, if you create a Server object for a NetWare 3™ server whose physical name on the network is SURFBOY, you must name the Server object SURFBOY.

Because of these restrictions, you can never rename a NetWare Server object, even if you have the Supervisor object right to it. For more information on NetWare Server objects, see “Object” in *Concepts*.

## Creating Searchable Leaf Objects

When you create an object, you enter various types of information about that object into its properties. An object’s properties can include a telephone number, a description, an address, etc.

Many object properties are optional; you are not required to enter information about such properties to create the object. However, information in objects’ properties can help you track and manage those objects.

After you have created objects, you can use the NetWare Administrator, NETADMIN, or NLIST utility to search for and list these objects. You can also search for the values contained in the objects’ properties.

If you enter data into the properties in a consistent format, it is easier to search the Directory database for different types of information when you need it.

For example, you may want to search for all User objects at a certain location, such as building M1. You cannot easily list all objects located in building M1 if you have entered “Bldg. M1,” “BLDG M1,” and “M1” as values in the Location property of multiple User objects.

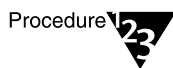
Standardizing the value for the Location property for all User objects at the site (such as M1, M2, and M3) makes it possible to search for objects located in each building.

## Creating Leaf Objects Using NetWare Administrator



### Prerequisites

- A 386 or 486 workstation running NetWare Administrator
- The Create object right to the container that will contain the new leaf object



### Procedure

1. **Choose the “NetWare Administrator” icon from the MS Windows Program Manager or the OS/2 desktop.**
2. **Select the object that will contain the new leaf object.**

For information on moving around in the browser and selecting objects, press <F1>.



If you are creating User objects, remember that users who are using non-NetWare 4.11 workstations must be created in the container where the bindery services context is set for the server that they need to log in to.

You can create User objects for users who have NetWare 4.11 workstations anywhere in the Directory tree, but the users must know their context in order to log in. You should create User objects in the container where the users will typically log in.

3. **Choose “Create” from the “Object” menu.**
4. **From the “New Object” dialog, select the class of object you want to create.**

If the class of object you selected does not appear under “New Object,” you cannot create this object in this container. Select or create another container to hold the object.

5. **Choose “OK.”**

Each type of leaf object that you create has a different “Create” dialog. For details on each dialog, choose “Help.”

The property fields that are displayed in the “Create” dialog are mandatory. You must enter information in these fields.

The check boxes that are displayed in the “Create” dialog are optional. Usually, you can select only one box, not both.

For example, if you select “Define Additional Properties,” the “Identification” page is displayed immediately after the object is created. If you select “Create Another Object,” another “Create” dialog is displayed immediately after the object is created.

## 6. Choose “Create.”

If you chose “Define Additional Properties,” the object dialog appears. If you chose “Create Another Object,” another “Create Object” dialog appears.

### Additional Information

For more information about	See
Objects	“Object” in <i>Concepts</i>
Using the NetWare Administrator utility	“NetWare Administrator” in <i>Utilities Reference</i>
Using the object dialog in NetWare Administrator	“NetWare Administrator” in <i>Utilities Reference</i>

## Creating Leaf Objects Using NETADMIN



### Prerequisites

- A workstation running DOS 3.30 or later
- The Create object right to the container object that will contain the new leaf object

## Procedure



### 1. At the DOS prompt, type

`NETADMIN <Enter>`

For information on moving around in NETADMIN and selecting objects, press <F1> after starting the utility.

### 2. Choose “Manage Objects” from the “NETADMIN Options” menu.

### 3. Select the container that will contain the new leaf object.

The objects in the selected container are listed.

To see if you’re in the right context, look at the title bar on the screen.

Press <F1> if you need help.



If you are creating User objects, remember that users who are using non-NetWare 4.11 workstations must be created in the container at which the bindery services context is set for the server that they need to log in to.

You can create User objects for users who have NetWare 4.11 workstations anywhere in the Directory tree, but the users must know their context in order to log in. You should create User objects in the container where the users will typically log in.

### 4. Press <Insert>.

### 5. From the “Select an Object Class” screen, select the object class that you want to create.

If the object class you want to create does not appear, you cannot create that object in the selected container. Press <Esc> to return to the browser; then select a different container type.

### 6. Type the information you are prompted for and press <Enter>.

Each leaf object that you create has a different dialog. For details on each dialog, press <F1> for help.

- 7. If you want to create another leaf object, choose “Yes.” If you do not, choose “No.”**

If you choose “Yes,” you are prompted for information about the next object you want to add. Repeat Step 6, and then continue with Step 8.

If you choose “No”, the leaf object is displayed in the Directory tree. Continue with the next step.

- 8. Press <F10> to edit this object.**

A menu appears from which you can choose to view or edit information about this object.

- 9. Choose an option from the “Actions” menu and add any necessary information.**

- 10. To exit, press <Esc> until you return to the “NETADMIN Options” menu.**

### Additional Information

---

<b>For more information about</b>	<b>See</b>
Objects	“Object” in <i>Concepts</i>
Using the NETADMIN utility	“NETADMIN” in <i>Utilities Reference</i>

---

# Managing Groups of User Objects

NetWare 4.11 allows you to manage User objects as a group, which is often more efficient than managing them individually. Six objects that can help you manage groups of User objects are described in Table 1-6.

**Table 1-6**  
**Objects That Help Manage Users**

Object	Description
Organization object	Allows you to assign trustee rights, login scripts, and user defaults to the User objects in the Organization.
Organizational Unit object	Allows you to assign trustee rights, login scripts, and user defaults to the User objects in the Organizational Unit.
Group object	Provides an efficient way for you to manage only one object, the Group object, instead of many individual User objects.
Profile object	Allows you to set up a specific work environment by using a common login script for groups of users who need similar work environments but who are not located in the same container object.
Organizational Role object	<p>Allows you to assign rights to a particular position and set of responsibilities, rather than to a person. The person who occupies that position may change frequently, but the responsibilities of that position do not.</p> <p>The difference between a Group object and an Organizational Role object is that a Group object usually has many members, whereas an Organizational Role object usually has only one or two.</p>
USER_TEMPLATE	Allows you to apply default property values to any user that you create in a container object. You can choose to apply the information in the user template when you create new User objects.

## Managing Group Objects

If you want a user to have access to an object, you must make a trustee assignment to that object. Rather than make trustee assignments to many users, you can create a Group object and then, with just one trustee assignment, grant access to all the users who belong to the Group.

If a trustee assignment names a Group object as the trustee, every user in the membership list of the Group object is granted the same access that is granted to the Group object.

After you have created a Group object and added User object names to it, you manage the rights of the Group object rather than the rights of the individual group members.

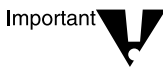
For example, suppose you have a word processing application on the network that many users need to access. You could create a Group object named WORD PROCESSOR USERS and add the User object names of the users who need access to the application.

Then, rather than granting file trustee rights to each of the individual User objects, you grant the file trustee rights to the Group object WORD PROCESSOR USERS for the application and the working directory.

The users can then use the word processing application just as if you had granted them file trustee rights to the application individually.

When a user is added to the membership list of a Group object, the Group is listed in that user's Security Equal To property. Security Equal To is a property of every User object that lists other objects. The user is granted all rights that any object (User, Group, Printer, etc.) in that list is granted, both object and file rights.

Only User objects can be listed in a Group, and you can add User objects from any part of the Directory tree to a Group.



A Group object is *not* a container. It does not "contain" User objects; users' names are merely assigned to a Group object.

To create a Group object, see “Creating Leaf Objects” on page 26.

You must create User objects before you can add them to the membership list of a Group object. See “Creating Leaf Objects” on page 26 for instructions on creating User objects.

After you have created a Group object, use the following procedures to

- ◆ Add members to a Group object
- ◆ Give a Group object rights to files and directories
- ◆ Delete members from a Group object

You can use either the NetWare Administrator or NETADMIN utility to manage Group objects. Both procedures are documented in this section.

<b>For more information about</b>	<b>See</b>
Groups	“Group object” in <i>Concepts</i>
Object and property rights	“Rights Needed to Create and Manage Objects” on page 9
Using the NETADMIN utility	“NETADMIN” in <i>Utilities Reference</i>
Using the NetWare Administrator utility	“NetWare Administrator” in <i>Utilities Reference</i>



## Adding Members to a Group Object Using NetWare Administrator

Checklist



### Prerequisites

- A 386 or 486 workstation running NetWare Administrator
- At minimum, the Write right to the Members property of the Group object
- At minimum, the Write right to the Security Equal To property of the User object
- At minimum, the Write right to the ACL property of the Group object
- The Group object must already exist, and the User objects you want to add as members of the Group must already exist

Procedure



### Procedure

1. **Choose the “NetWare Administrator” icon from the MS Windows Program Manager or the OS/2 desktop.**
2. **Select the Group object you want to edit.**  
  
For information on moving around in the browser and selecting objects, press <F1>.
3. **Choose “Details” from the “Object” menu.**
4. **Select the “Members” button at the right side of the “Object” dialog.**
5. **Choose the “Add” button to browse the Directory tree for User objects.**
6. **Browse the Directory tree until the User object you want appears in the “Objects” box.**
7. **Choose “OK.”**
8. **Repeat Steps 5 through 7 to add more User objects to the Group object.**

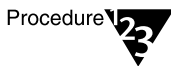
9. When you have finished adding User objects to the Group object, choose “OK” to save your changes and return to the browser.

## Adding Members to a Group Object Using NETADMIN



### Prerequisites

- A workstation running DOS 3.30 or later and the NETADMIN utility
- The Supervisor right to the Group object, or the Write or Supervisor right to the Members property of the Group object
- The Supervisor right to the Group object, or the Write or Supervisor right to the Security Equal To property of the User object
- The Supervisor or Write right to the ACL property of the Group and User objects
- The Group object must already exist, and the User objects you want to add as members of the Group must already exist



### Procedure

1. At the DOS prompt, type

`NETADMIN <Enter>`

For information on moving around in NETADMIN and selecting objects, press <F1> after starting the utility.

2. Choose “Manage Objects” from the “NETADMIN Options” menu.
3. Browse the Directory until the Group object appears on the screen.

Use the instructions at the bottom of the screen to browse the directory. Press <F1> if you need help.

4. **When the Group object appears in the “Object” list, select it and press <F10>.**

The “Actions” menu appears.

5. **Choose “View or Edit Properties of This Object.”**
6. **Choose Group members from the “View or Edit Group” menu.**
7. **Press <Insert> at the “Group Members” screen, and then press <Insert> again to browse for the User object you want to add to the Group object.**
8. **When the User object you want to add appears in the Directory, select it and press <F10>.**
9. **When the selected User object appears in the “Members” screen, press <Enter>.**

To select multiple User objects, use <F5>.

10. **Continue to press <Insert> and select User objects until you have added all the users you want as Group members.**
11. **To save the list of Group members, press <F10>.**
12. **To exit, press <Esc> until you return to the “NETADMIN Options” menu.**

## **Giving Group Object Rights to Files and Directories Using NetWare Administrator**



### **Prerequisites**

- A workstation running NetWare Administrator
- The Read object right to the Volume object
- Rights to the file system

## Procedure

1. **Choose the “NetWare Administrator” icon from the MS Windows Program Manager or the OS/2 desktop.**

2. **Select the Group object you want to edit.**

For information on moving around in the browser and selecting objects, press <F1>.

3. **Choose “Details” from the “Object” menu.**

4. **Select the “Rights to File System” button on the right side of the “Object” dialog.**

5. **To select a volume, select “Include.”**

A list of volumes appears in the “Select Object” box. Or, you can browse the Directory for a volume.

6. **From the “Volumes” list, select the volume that contains the directory or file.**

7. **Choose “Add.”**

8. **Select the volume that contains the directory or file you want to grant rights to.**

9. **From the “Files and Directories” dialog, select the directory or file that you want to grant rights to.**

The default rights that make up this object’s trustee assignment to the file or directory appear in the “Rights” area.

10. **Select the check boxes next to the rights that you want to add.**

You must have the Access Control right to the file or directory to make trustee assignments to the file or directory.

11. **Choose “OK.”**

The new trustee assignment is now effective for this object.

## Giving Group Object Rights to Files and Directories Using NETADMIN

Checklist



### Prerequisites

- A workstation running DOS 3.30 or later and the NETADMIN utility
- The Read object right to the Volume object
- Rights to the file system

Procedure



### Procedure

**1. At the DOS prompt, type**

`NETADMIN <Enter>`

For information on moving around in NETADMIN and selecting objects, press <F1> after starting the utility.

**2. Choose “Manage Objects” from the “NETADMIN Options” menu.**

**3. Browse the Directory until the Group object appears on the screen.**

Use the instructions at the bottom of the screen to browse the directory. Press <F1> if you need help.

**4. When the Group object appears in the “Object” list, select it and press <F10>.**

The “Actions” menu appears.

**5. Choose “View or Edit Rights to Files and Directories.”**

**6. Select a Volume where you want to make the Group object the trustee of a directory or file.**

Press <Insert> to type the Volume object name or press <Insert> twice to browse the Directory.

**7. Press <Insert> to type a beginning pathname to the directories in which you want to make trustee assignments, or press <Insert> again to browse for the path.**

- 8. Select “Directories/Files” and press <Enter>.**

Choose whether you want to view files, directories, or both when you are selecting one to give a trustee assignment to.

- 9. Select “Trustee Search Depth” and press <Enter>.**

Choose whether you want to view only the files or directories in the current directory, or to search subdirectories.

- 10. To list the trustee assignments, press <F10>.**

The “Trustee Directory Assignments” screen appears.

- 11. To select a directory or file in which the Group object should be added as a trustee, press <Insert>.**

- 12. To accept the directory you specified earlier, press <Enter>; or, to browse for file system directories, press <Insert>.**

- 13. To add or delete the rights granted, select “Trustee Directory Assignments” and press <Enter>.**

The “Trustee Rights Granted” menu appears.

- 14. To view or add rights that are not yet granted, press <Insert>.**

Press <F1> if you help.

- 15. To save the trustee assignments, press <F10>.**

- 16. Continue selecting directories and files and granting rights until finished.**

- 17. To exit, press <Esc> until you return to the “NETADMIN Options” menu.**

## Deleting Members from a Group Object Using NetWare Administrator

Checklist



### Prerequisites

- A workstation running NetWare Administrator
- The Supervisor right to the Group object, or the Write or Supervisor right to the Members property of the Group object
- The Supervisor right to the Group object, or the Write or Supervisor right to the Security Equal To property of the User object
- The Supervisor or Write right to the ACL property of the Group and User objects

Procedure



### Procedure

1. **Choose the “NetWare Administrator” icon from the MS Windows Program Manager or the OS/2 desktop.**
2. **Select the Group object you want to edit.**  
  
For information on moving around in the browser and selecting objects, press <F1>.
3. **Choose “Details” from the “Object” menu.**
4. **Select the “Members” button at the right side of the “Object” dialog.**  
  
The list of User objects for this group appears.
5. **From the “Members” dialog, select the name you want to delete.**
6. **Choose “Delete.”**
7. **If you want to delete other names, continue selecting names and choosing “Delete.”**

Note



You can delete several users at a time by holding down the button on the mouse, dragging the mouse arrow over the names, and choosing “Delete.”

8. When you have finished deleting members, choose “OK” to save your changes and return to the browser.

## Deleting Members from a Group Object Using NETADMIN

Checklist



### Prerequisites

- A workstation running DOS 3.30 or later and the NETADMIN utility
- The Supervisor right to the Group object, or the Write or Supervisor right to the Members property of the Group object
- The Supervisor right to the Group object, or the Write or Supervisor right to the Security Equal To property of the User object
- The Supervisor or Write right to the ACL property of the Group and User objects

Procedure



### Procedure

1. At the DOS prompt, type

`NETADMIN` <Enter>

For information on moving around in NETADMIN and selecting objects, press <F1> after starting the utility.

2. Choose “Manage Objects” from the “NETADMIN Options” menu.
3. Browse the Directory until the Group object appears on the screen.  
  
Use the instructions at the bottom of the screen to browse the directory. Press <F1> if you need help.
4. When the Group object appears in the “Object” list, select it and press <F10>.

The “Actions” menu appears.

5. Choose “View or Edit Properties of This Object.”



6. **Select Group members from the “View or Edit Groups” menu.**
7. **Select the User object you want to delete from the Group object and press <Delete>.**  
To select multiple User objects, use <F5>.
8. **To confirm the deletion, choose “Yes.”**
9. **To exit, press <Esc> until you return to the “NETADMIN Options” menu.**

## Managing Profile Objects

Profile objects contain login scripts that are used by groups of users who need similar work environments but who are not located in the same container object.

When a Profile object is named in a User object, the login script contained in the Profile object is executed when the user logs in, after any login script in the Organization or Organizational Unit has executed.

Users can have only one Profile, so only one profile script can execute for any user.

For information about creating a login script, see Chapter 3, “Creating Login Scripts,” on page 169.

For an example of a login script used in a Profile object, see “Profile Login Script” on page 245.

You can use either the NetWare Administrator or NETADMIN utility to create a Profile object. Both procedures are documented in this section.

For more information about	See
Profile objects	“Profile object” in <i>Concepts</i>
Creating login scripts	Chapter 3, “Creating Login Scripts,” on page 169
Using the NETADMIN utility	“NETADMIN” in <i>Utilities Reference</i>

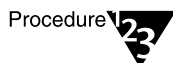
For more information about	See
Using the NetWare Administrator utility	"NetWare Administrator" in <i>Utilities Reference</i>

## Creating Profile Objects Using NetWare Administrator



### Prerequisites

- A workstation running NetWare Administrator
- The Create object right to the object that will contain the new Profile object



### Procedure

1. **Choose the "NetWare Administrator" icon from the MS Windows Program Manager or the OS/2 desktop.**

2. **Select the object that will contain the new Profile object.**

For information on moving around in the browser and choosing objects, press <F1>.



Only Organization and Organizational Unit objects can contain Profile objects.

3. **Choose "Create" from the "Object" menu.**

4. **Select "Profile" from the "New Object" dialog.**

The "Create Profile" dialog appears.

If Profile does not appear under "New Object," you cannot create Profile objects in this container. Select or create another object to contain the Profile object.

5. **Choose "OK."**

6. **Type the Profile object name in the box provided.**

**7. (Optional) Select “Define additional properties.”**

Select this option if you want to write a Profile login script or supply additional information about the new Profile object. Instructions for creating a Profile script are in Chapter 3, “Creating Login Scripts,” on page 169.

**8. Choose “Create.”**

If you selected “Define Additional Properties,” the “Identification” dialog appears.

**9. (Optional) Enter information in the fields provided in the “Identification” page of the “Object” dialog.**

**10. (Optional) Select the “See Also” button at the right side of the object dialog.**

The “See Also” page allows you to add information about the Profile object you are creating. For example, you might list the User objects to whom you have assigned this script.

Choose “Help” at any time for information on the current task.

**11. (Optional) Choose the “Login Script” page at the right side of the object dialog to add commands to the Profile login script.**

Use this page to specify commands that execute when a user logs in, such as a drive mapping.

**12. To save the new Profile object and return to the browser, choose “OK.”**

## Creating Profile Objects Using NETADMIN

Checklist



### Prerequisites

- A workstation running DOS 3.30 or later and the NETADMIN utility
- The Create object right to the object that will contain the new Profile object

Procedure



### Procedure

1. **At the DOS prompt, type**

**NETADMIN** <Enter>

For information on moving around in NETADMIN and selecting objects, press <F1> after starting the utility.

2. **Choose “Manage Objects” from the “NETADMIN Options” menu.**

3. **Select the object that will contain the new Profile object.**

The objects in the selected container are listed. To see if you're in the right context, look at the title bar on the screen.

Press <F1> if you need help.

4. **Press <Insert>.**

5. **Select “Profile.”**

If the Profile object class does not appear, you cannot create that object in the selected container. Press <Esc> to return to the browser, and then select a different container type.

6. **Type the new Profile object name and press <Enter>.**

7. **If you want to create another Profile object, choose “Yes.” If you do not, choose “No.”**

If you chose “Yes” you are prompted to type the new Profile object name. Repeat Steps 3 through 7, and then continue with Step 8.

If you chose “No,” then the Profile object is displayed in the Directory tree. Continue with Step 8.

8. **To edit this object, press <F10>.**

A menu appears from which you can choose to view or edit information about this object.

9. **Choose “View or Edit Properties of This Object.”**
10. **Choose “Login Script.”**
11. **To enter commands for this Profile login script, choose “No” or, to copy a login script from another Profile object, choose “Yes.”**

The commands you place in the Profile login script are executed when users who belong to this Profile object log in.

For information on the commands, press <F1> or see “Login Script Commands and Variables” on page 187.

12. **To save your changes, press <F10>.**
13. **To exit, press <Esc> until you return to the “NETADMIN Options” menu.**

## Managing Organizational Role Objects

An Organizational Role object allows you to assign rights to a particular position rather than to the person who occupies that position. The people who occupy that position may change frequently, but the responsibilities of the position do not.

The user assigned to an Organizational Role is called the occupant and is granted all rights that are granted to the Organizational Role object.

When a user is added to the occupant list of an Organizational Role object, the Organizational Role is listed in that user’s Security Equal To property.

Security Equal To is a property of every User object that lists other objects. The user is granted all rights that any object (User, Group, Printer, etc.) in that list is granted, both to objects and to files and directories.

You can use the NetWare Administrator or NETADMIN utility to create an Organizational Role object. Both procedures are documented in this section.

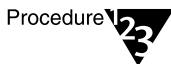
For more information about	See
Organizational Role object	“Organizational Role object” in <i>Concepts</i>
Security equivalence	“Security Equal To” in <i>Concepts</i>
Using the NETADMIN utility	“NETADMIN” in <i>Utilities Reference</i>
Using the NetWare Administrator utility	“NetWare Administrator” in <i>Utilities Reference</i>

## Creating Organizational Role Objects Using NetWare Administrator



### Prerequisites

- A workstation running NetWare Administrator
- The Create object right to the object that will contain the new Organizational Role object



### Procedure

1. Choose the “NetWare Administrator” icon from the MS Windows Program Manager or the OS/2 desktop.
2. Select the object that will contain the new Organizational Role object.

For information on moving around in the browser and selecting objects, press <F1>.



Only Organization and Organizational Unit objects can contain Organizational Role objects.

3. Choose “Create” from the “Object” menu.

4. **Select “Organizational Role” from the “New Object” dialog.**  
If “Organizational Role” does not appear under “New Object,” you cannot create Organizational Role objects in this container. Select or create another object to contain the Organizational Role object.
5. **Choose “OK.”**  
The “Create Organizational Role” dialog appears.
6. **Type the Organizational Role object name in the box provided.**
7. **(Optional) “Select Define Additional Properties.”**
8. **Select the “Create” button at the bottom of the window.**
9. **Enter information in the fields provided in the “Identification” dialog.**  
The “Identification” page of the “Object” dialog appears.
10. **Select the button to the right of “Occupant.”**
11. **Choose “Add.”**  
The “Select Object” window appears.
12. **Select User objects from the “Directory Context” window until the objects you want are shown in the “Object” window.**
13. **Select the User object in the left window to occupy the Organizational Role; then choose “OK.”**  
The object you selected appears in the “Occupant” window.
14. **Choose “OK” in the “Occupant” window.**
15. **When you are finished adding User objects as Occupants, choose “OK” in the “Organizational Role” window.**

16. **(Optional) Select the “See Also” button at the right side of the object dialog.**

The “See Also” page allows you to add information about the Organizational Role object you are creating. For example, you might list the User objects that you have assigned as occupants.

17. **To save the new Organizational Role object and return to the browser, choose “OK.”**

## Creating Organizational Role Objects Using NETADMIN

### Prerequisites



- A workstation running DOS 3.30 or later and the NETADMIN utility
- The Create object right to the object that will contain the new Organizational Role object

### Procedure



1. **At the DOS prompt, type**

`NETADMIN <Enter>`

For information on moving around in NETADMIN and selecting objects, press <F1> after starting the utility.

2. **Choose “Manage Objects” from the “NETADMIN Options” menu.**
3. **Select the object that will contain the new Organizational Role object.**

The objects in the selected container are listed. To see if you’re in the right context, look at the title bar on the screen.

Press <F1> if you need help.

4. **Press <Insert>.**



**5. Select “Organizational Role.”**

If the Organizational Role object class does not appear, you cannot create that object in the selected container. Press <Esc> to return to the browser, and then select a different container type.

**6. Type the new Organizational Role object name.**

**7. Type the Mailbox Location and press <Enter>.**

**8. If you want to create another Organizational Role object, choose “Yes.” If you do not, choose “No.”**

If you chose “Yes,” you are prompted to type the new Organizational Role object name. Repeat Step 6 and then continue with Step 8.

If you chose “No,” then the Organizational Role object is displayed in the Directory tree. Continue with Step 9.

**9. To edit this object, press <F10>.**

A menu appears from which you can choose to view or edit information about this object.

**10. Choose “View or Edit Properties of This Object.”**

**11. Choose “Identification” from the “View or Edit Organizational Role” menu.**

**12. Specify a User object for the Organizational Role.**

**12a. Select the field next to “Occupant” and press <Enter>.**

**12b. Press <Insert>.**

**12c. Type the complete name of a User object in the space provided, or press <Insert> to browse the Directory and select a User object to be the occupant of the Organizational Role.**

The path from the object to the root of the tree forms the object’s complete name.

**13. Select additional User objects as needed.**

**14. To save the list of occupants, press <F10>.**

15. Enter information in other fields as needed.
16. To save changes, press <F10>.
17. To exit, press <Esc> to return to the “NETADMIN Options” menu.

## Managing User Templates



The following information applies only to the NETADMIN text utility and not to the NetWare Administrator graphical utility. Under NetWare 4.11, the NetWare Administrator utility no longer supports the USER\_TEMPLATE object, but instead supports the new Template class of objects. For more information, see “Managing User Accounts” in the NetWare Administrator online help.

A user template contains default information that you can apply to User objects to give them default property values.

You can create a user template in an Organization or Organizational Unit object either when you create the container object or later on.

Then, when you create a User object, you are prompted to use the defaults in the user template. If you do, the property values you entered in the user template, such as login time restrictions, password restrictions, etc., are copied into the User object’s properties.

The user template is actually a User object named USER\_TEMPLATE. You enter information in this User object just as you would for any other User object. However, not all properties of a User object can be copied from a user template.

When you create a user template, you can copy information from the parent container’s user template. For example, if you create a user template in SALES.NOVELL, you are prompted to copy the user template from NOVELL, if one exists. Using this feature, you can avoid having to reenter similar information for lower-level containers.

User template information is taken from the nearest parent container. If the container object in which you create a User object does not have a user template, you can apply the parent container’s user template to the User object.

When working with user templates, remember the following:

- ◆ Changing values in a user template does not change those values in existing User objects. The changes apply only to User objects created after the user template values have been changed.
- ◆ To update information for existing users, you must enter the changes for each User object.
- ◆ You cannot use a user template to grant NDS or file system rights.

You can use the NetWare Administrator or NETADMIN utility to create a user template. Both procedures are documented in this section.

<b>For more information about</b>	<b>See</b>
User defaults	"User template" in <i>Concepts</i>
User objects	"User object" in <i>Concepts</i>
Using the NETADMIN utility	"NETADMIN" in <i>Utilities Reference</i>
Using the NetWare Administrator utility	"NetWare Administrator" in <i>Utilities Reference</i>

## Creating and Editing User Templates with NetWare Administrator

Checklist



### Prerequisites

- A workstation running NetWare Administrator
- The Create object right to the container object that will contain the user template

### Procedure

For information on creating and editing user Template objects using NetWare Administrator, see “Create Templates, Users, and Profiles” in the NetWare Administrator online help.

## Creating and Editing User Templates with NETADMIN

Checklist



### Prerequisites

- A workstation running DOS 3.30 or later
- The Create object right to the container object that will contain the user template

### Procedure

Procedure



#### 1. At the DOS prompt, type

`NETADMIN <Enter>`

For information on moving around in NETADMIN and selecting objects, press <F1> after starting the utility.

2. **Choose “Manage Objects” from the “NETADMIN Options” menu.**

3. **Browse the Directory tree to find and select the container object in which you want to add a new container object.**

The objects in the selected container are listed.

To see if you’re in the right context, look at the title bar on the screen. Press <F1> for help.

4. **Press <Insert>.**
5. **From the “Select an Object Class” screen, select the container type that you want to create.**

If the container object class you want to create does not appear, you cannot create that object in the selected container. Press <Esc> to return to the browser, and then select a different container type.

6. **Type the new container object name and press <Enter>.**
7. **If you want to create a user template to be applied to new User objects created in this container, type “Y” and press <Enter>.**



You are not prompted to create a user template if you are creating a Country container object.

8. **Choose “View or Edit Properties of This Object.”**
9. **Choose “Edit Template User.”**

The “View or Edit User” screen appears.

10. **Enter or change the values of the user template as needed.**

The help line at the bottom of the screen gives information on each of the options as you highlight them.

For more information, press <F1>.

11. To save the information, press <F10>.
12. To exit, press <Esc> until you return to the “NETADMIN Options” menu.

## Searching for Objects

When you want to find information in the Directory database without opening numerous containers to view the objects, you can use the Search feature.

With the Browse object right, you can search for object classes anywhere in the Directory tree. With the Compare property right, you can search for objects with properties that match a particular value.

You can search for objects using the NetWare Administrator, NETADMIN, or NLIST utility. All three procedures are documented in this section.

### Searching for Objects Using NetWare Administrator

The NetWare Administrator utility searches each object in the Directory database unless you narrow the search by specifying properties in combination with additional variables such as “less than” or “equal to.”

For example, to find all users in New York, you could search for User objects with State or Province Name “equal to” New York. The Search feature then displays objects that meet the search criteria.

#### Prerequisites



- A workstation running NetWare Administrator
- The Browse object right to the object you want to see in the search

## Procedure

1. **Choose the “NetWare Administrator” icon from the MS Windows Program Manager or the OS/2 desktop.**
2. **Select an object in the Directory tree where the search should start.**
3. **Choose “Search” from the “Object” menu.**

A “Search” window appears.
4. **Choose the browser icon (to the right of the “Start From” field) to select an object to start the search from.**
5. **Specify how much of the Directory tree to search.**
  - ◆ To search everything below the “Start From” object, select “Search Entire Subtree.”
  - ◆ To search only among objects one level below the “Start From” object, do not select “Search Entire Subtree.” Continue with Step 6.
6. **Select the down-arrow to the right of the “Search for” field to select an object class to search for.**
  - ◆ Choose “OK” if you want all the objects of this selected object class to be listed.
  - ◆ If you want only those objects having properties that match certain criteria to be listed, continue with Step 7.
7. **(Optional) Select the down-arrow to the right of the “Property” field to select which property’s value will be examined.**

The properties in this list change depending on which object class you selected in the “Search for” field.
8. **(Optional) Select how you want to compare a value to the selected property.**

You can select “Equal to,” “Greater than,” “Less than,” or other choices.

**9. (Optional) Enter a value in the field to the right of the comparison method that you entered in Step 8.**

For example, if you are searching for a Profile object that has the value “Manager’s Profile” in the Other Names property, you might select the property “Other Names,” then use the comparison method “Equal To” and the value of “Manager’s Profile.”

**10. Choose “OK.”**

Objects that match your selections are displayed in a “Search Results” window.

**Additional Information**

For more information about	See
Properties	“Property” in <i>Concepts</i>
Using the NetWare Administrator utility	“NetWare Administrator” in <i>Utilities Reference</i>

## Searching for Objects Using NETADMIN

NETADMIN searches each object in the Directory database unless you narrow the search by specifying properties in combination with additional variables such as “less than” or “equal to.”

For example, to find all users in New York, you could search for User objects with State or Province Name “equal to” New York. The Search feature then displays objects that meet the search criteria.

### Prerequisites



- A workstation running DOS 3.30 or later
- The Browse object right to the object you want to see in the search





## Procedure

1. **At the DOS prompt, type**

`NETADMIN <Enter>`

For information on moving around in NETADMIN and selecting objects, press <F1> after starting the utility.

2. **Choose “Manage According to Search Pattern” from the “NETADMIN Options” menu.**

3. **Enter the object name you wish to search on in the “Enter Object Name” field, use \* to view all objects, or limit the search by combining characters with the \*.**

For example, if you want to view all objects whose names begin with “P,” enter “P\*” in the “Enter Object Name” field.

4. **Select the object class or classes you want to search on in the “Object Class” field. To search on all object types, select “/All classes/.”**

**4a. Press <Enter> to select the object classes.**

**4b. If the object classes you want to search on don’t appear in the “Object Classes Included” screen, press <Insert> to select additional object classes.**

5. **Choose “Yes” in the “Show Alias Class” field if you want to view an Alias object as an alias, and not as the object the alias represents.**

6. **Press <F10>.**

Objects that match your selections are displayed in the browse screen.

## Additional Information

For more information about	See
Properties	“Property” in <i>Concepts</i>
Using the NETADMIN utility	“NETADMIN” in <i>Utilities Reference</i>

## Searching for Objects Using NLIST

NLIST is a workstation command line utility that allows you to

- ◆ List objects and object properties
- ◆ View information about users, groups, volumes, and servers (such as object properties, names, property groups, and login information)
- ◆ Search for objects and object properties (including groups of properties for objects) on NetWare 2 and NetWare 3 servers

For instructions on using NLIST, see “NLIST” in *Utilities Reference*.

## Moving Objects in the Directory Tree

While previous versions of NetWare allowed you to move only leaf objects, NetWare 4.11 allows you to move both leaf objects and container objects to other containers in the Directory tree.

You can move a container object only if it is the root of a Novell Directory Services (NDS) partition that has no subordinate partitions.

When you move a container object, create an alias object that points to the container object you’re moving. Then users can continue logging in to the network and finding the container object (and the objects it contains) in its original Directory location.



Important

If you move a container object and do not create an alias, users who are unaware of the object's new location will not easily find the object in the Directory tree, since they will look for it in its original Directory location.

Also, users may not be able to log in if the name context in their configuration file (NET.CFG file) references the moved container.

When you move a leaf or container object, NDS changes all references to the moved object. Although the object's common name remains unchanged, the context name of the object (and of all its subordinates) changes.

Because the context of a container object changes when you move it, users whose name context in their configuration file (NET.CFG file) references the moved container need to update their NET.CFG so that it references the container's new name.

To automatically update users' NET.CFG file with a new name context after you move a container object, use the NCUPDATE utility. For instructions, see "NCUPDATE" in *Utilities Reference*.

You can use NetWare Administrator or NETADMIN to move objects in the Directory tree. Both procedures are documented in this section.

## Moving Leaf Objects Using NetWare Administrator



Checklist

### Prerequisites

- A workstation running NetWare Administrator
- The Supervisor right o the object you want to move
- The Create object right to the destination container

### Procedure



Procedure

1. **From the MS Windows Program Manager or the OS/2 desktop, choose the "NetWare Administrator" icon.**
2. **From the browser window, select one or more leaf objects.**

To select multiple leaf objects, press <Ctrl> on the keyboard and, without releasing <Ctrl>, select the objects with the mouse.

3. From the “Object” menu, choose “Move.”
4. Select the browser button to the right of the “Destination” box.

The “Directory Context” box appears in the lower right corner of the screen. Use this field to browse the Directory tree’s containers.

The “Objects” box that appears in the lower left corner shows the containers that appear when you browse the Directory.

5. From the “Objects” box, select a container object (an Organization or Organizational Unit) as the place to move the objects to; then choose “OK.”
6. In the “Move” dialog, choose “OK.”

The listed objects are moved to the destination container.

### Additional Information

For more information about	See
Directory tree	“Directory tree” in <i>Concepts</i>
Using the NetWare Administrator utility	“NetWare Administrator” in <i>Utilities Reference</i>
Objects	“Object” in <i>Concepts</i>
Rights	“Rights” in <i>Concepts</i>

## Moving Leaf Objects Using NetWare Administrator (Drag-and-Drop)

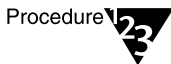
NetWare Administrator allows you to move an object to a different location in the Directory tree using the drag-and-drop method.

### Prerequisites



- A workstation running NetWare Administrator
- The Supervisor right to the object you want to move
- The Create object right to the destination container

### Procedure



1. **From the MS Windows Program Manager, choose the “NetWare Administrator” icon.**
2. **(Optional) From the “Tools” menu, open another browser window by selecting “Browse.”**

If you can see both the object and the destination container in one browser window, it is not necessary to open two browser windows. Go directly to Step 4.

3. **Reshape the browser windows, using the window borders, so that you can view both windows at once.**
4. **From one of the browser windows, select one or more leaf objects.**

To select multiple leaf objects, press <Ctrl> on the keyboard and, without releasing <Ctrl>, select the objects with the mouse.

5. **Press <Ctrl> on the keyboard and, without releasing <Ctrl>, click and hold down on the object(s) and drag the object(s) to the destination container; then release the mouse button.**
6. **In the “Move” dialog, choose “OK.”**

The listed objects are moved to the destination container.

## Additional Information

For more information about	See
Objects	“Object” in <i>Concepts</i>
Rights	“Rights” in <i>Concepts</i>
Directory tree	“Directory tree” in <i>Concepts</i>
Using the NetWare Administrator utility	“NetWare Administrator” in <i>Utilities Reference</i>

## Moving Leaf Objects Using NETADMIN

Checklist



### Prerequisites

- A workstation running DOS 3.30 or later and the NETADMIN utility
- The Create object right to the destination container
- The Supervisor right to the object you want to move

Procedure



### Procedure

1. **At the DOS prompt, type**

**NETADMIN** <Enter>

For information on moving around in NETADMIN and selecting objects, press <F1> after starting the utility.

2. **From the “NETADMIN Options” menu, choose “Manage Objects.”**

Your current context appears in the upper left corner.

3. **Select the object that you want to move.**
  - ◆ If the object you want to move appears on the list, select it and press <F10>.
  - ◆ If the object is not on the list, browse the Directory by selecting container objects and pressing <Enter> until you see the object you want. Select it and press <F10>.
4. **From the “Actions” menu, choose “Move.”**
5. **Using the Down-arrow key to reach the field, highlight the “New Context” field.**
6. **Assign a new context to the object you want to move.**
  - ◆ If you know the new context that you want the object to be in, type the new context in the highlighted field.
  - ◆ If you don’t know the new context that you want the object to be in, press <Insert> twice to browse the Directory for the destination container; then select the destination container and press <F10>.
7. **To accept the new context as the destination container, press <Enter>.**
8. **To confirm that you want to move the object listed in the “Old Context” field to the container listed in the “New Context” field, press <F10>.**

The selected object is moved to the destination container.



You need to wait for processes throughout the Directory to be completed before you can move this object again.

## Additional Information

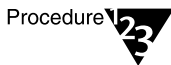
For more information about	See
Objects	“Object” in <i>Concepts</i>
Rights	“Rights” in <i>Concepts</i>
Directory tree	“Directory tree” in <i>Concepts</i>
Using the NETADMIN utility	“NETADMIN” in <i>Utilities Reference</i>

## Moving Container Objects Using NetWare Administrator



### Prerequisites

- A workstation running NetWare Administrator
- The Supervisor right to the object you want to move
- The Create object right to the destination container



### Procedure

1. From the MS Windows Program Manager or the OS/2 desktop, choose the “NetWare Administrator” icon.
2. From the “Tools” menu, choose “Partition Manager.”
3. From the “Partition Manager” browser, select the partition that you want to move.

You can move a container object only if it is the root of a Novell Directory Services (NDS) partition, and only if it contains no subordinate partitions.

In Partition Manager, the partition icon appears to the left of the object icon. If the container you want to move is not a partition, select the container and choose “Create as New Partition.”

4. From the “Object” menu, choose “Move Partition.”
5. Select the browser button to the right of the “Destination” box.



Use the browser in the “Directory Context” box to view the Directory tree’s containers.

The “Objects” box that appears in the lower left corner shows the containers that you select in the “Directory Context” box.

6. From the “Objects” box, select a container object (an Organization or Organizational Unit) as the place to move the listed objects to; then choose “OK.”

7. Choose “Create Alias in Place of Moved Container.”

The alias object will point to the partition’s new location.



If you move a container object and do not create an alias, users who are unaware of the object’s new location will not easily find the object in the Directory tree, since they will look for it in its original Directory location.

Also, users may not be able to log in if the name context in their configuration file (NET.CFG file) references the moved container.

8. In the “Move” dialog, choose “OK.”

If you chose to create an alias in place of the moved container, NetWare Administrator polls for the creation of the alias object before it moves the selected partition.

If you moved a container and created an alias in its place, you should use the NCUPDATE utility to update the name context of users in the moved container. For instructions, see “NCUPDATE” in *Utilities Reference*.

### Additional Information

For more information about	See
Objects	“Object” in <i>Concepts</i>
Rights	“Rights” in <i>Concepts</i>
Alias objects	“Alias object” in <i>Concepts</i>
Directory tree	“Directory tree” in <i>Concepts</i>
NCUPDATE	“NCUPDATE” in <i>Utilities Reference</i>
Using the NETADMIN utility	“NETADMIN” in <i>Utilities Reference</i>

# Moving Container Objects Using NETADMIN

Checklist



## Prerequisites

- A workstation running DOS 3.30 or later and the NETADMIN utility
- The Create object right to the destination container

Procedure



## Procedure

### 1. At the DOS prompt, type

`NETADMIN <Enter>`

For information on moving around in NETADMIN and selecting objects, press <F1> after starting the utility.

### 2. From the “NETADMIN Options” menu, choose “Manage Objects.”

Your current context appears in the upper left corner.

### 3. Select the object that you want to move.

- ◆ If the object you want to move appears on the list, select it and press <F10>.
- ◆ If the object is not on the list, browse the Directory by selecting container objects and pressing <Enter> until you see the object you want. Select it and press <F10>.

**4. From the “Actions” menu, choose “Move.”**

You can move a container object only if it is the root of a Novell Directory Services (NDS) partition, and only if it contains no subordinate partitions.

In NETADMIN, when you select a container object that is a partition, the context-sensitive help at the bottom of the screen reads “This is a partition.”

If the container you want to move is not a partition, you must first use a partition management utility (PARTMGR or NetWare Administrator) and create the container as a new partition.

**5. Using the Down-arrow key to reach the field, highlight the “New Context” field.**

**6. Assign a new context to the object you want to move.**

- ◆ If you know the new context that you want the object to be in, type the new context in the highlighted field.
- ◆ If you don't know the new context that you want the object to be in, press <Insert> twice to browse the Directory for the destination container; then select the destination container and press <F10>.

**7. To accept the new context as the destination container, press <Enter>.**

**8. To confirm that you want to move the object listed in the “Old Context” field to the container listed in the “New Context” field, press <F10>.**

**9. To create an alias in place of the moved container, choose “Yes.”**



If you don't create an alias, users who are unaware of the object's new location cannot easily find the object in the Directory tree, since they will look for it in its original Directory location.

Also, users might not be able to log in if the name context in their configuration file (NET.CFG file) references the moved container.

The alias object will point to the partition's new location.

The selected object is moved to the destination container.



Note

You need to wait for processes throughout the Directory to be completed before you can move this object again.

If you moved a container, and created an alias in its place, you should use the NCUPDATE utility to update the name context of users in the moved container. For instructions, see “NCUPDATE” in *Utilities Reference*.

### Additional Information

For more information about	See
Objects	“Object” in <i>Concepts</i>
Rights	“Rights” in <i>Concepts</i>
Directory tree	“Directory tree” in <i>Concepts</i>
Using the NETADMIN utility	“NETADMIN” in <i>Utilities Reference</i>

## Deleting Objects from the Directory Tree

When you delete leaf objects, Novell Directory Services (NDS) removes references to the deleted object. For example, if you delete a Profile object, that Profile object is deleted from any User objects that list it. Or, if you delete a User object, all trustee assignments listing that user are deleted.

Some special considerations apply when you delete particular objects, such as a NetWare Server object, a User object, or an Alias object. These cautions are explained in the next three sections.



Important

You cannot undo a Delete Object operation. To get the object back, you must re-create it and reenter all data in its properties.

You can use NetWare Administrator or NETADMIN to delete objects from the Directory tree. Both procedures are documented in this section.

## Cautions When Deleting NetWare Server Objects

An NDS NetWare server is one that you have installed in the Directory tree. Any server that is not in the Directory tree is a bindery server.

You can use NetWare Administrator or NETADMIN to delete bindery servers. But consider the following before you delete an NDS Server object:

- ◆ You cannot delete a NetWare server from the Directory tree using the NETADMIN utility.
- ◆ You must use the Partition Manager tool in the NetWare Administrator utility to delete an NDS NetWare server from the Directory tree.
- ◆ If the server you want to delete contains a master replica, you must first change the master to a different type and designate another replica on another server as the master.

## Cautions When Deleting User Objects

You must be careful not to delete a trustee object which has the only trustee assignment to a part of the Directory tree. If you did, you could cut off access to that part of the Directory tree.

You must also be careful not to block everyone's rights to an object with an Inherited Rights Filter, leaving no one with access to part of the Directory tree.

Therefore, be aware of the following before you delete a User object:

- ◆ To avoid losing access to any object, check the "Rights to Other Objects" and "Trustees of This Object" attributes of the User object you want to delete. To view these attributes, select the User object, and right-click once. Then select the attribute you want to view from the available options.

If the User object you want to delete has the Supervisor right to another object, transfer that Supervisor right to another User object before you delete the original User object.

Or, give a User object in a higher container object the Supervisor right to objects, and then block other users from deleting those objects.

- ◆ Do not delete user ADMIN until you have given another User object the same Supervisor right that ADMIN has.
- ◆ When you delete a User object, any security equivalences that you have assigned to other trustees are lost.
- ◆ When you delete a User object, the home directories and mail directories will not be deleted.

## Cautions When Deleting Alias Objects

Be aware of the following before you delete an Alias object:

- ◆ If you delete an alias object (which appears as the actual object it is pointing to), you only delete the alias object, not what it points to.

When you delete an alias object, it does not affect the object that the alias object points to.

- ◆ If you delete the object that an alias object points to, the alias object is also deleted.

# Deleting Objects Using NetWare Administrator



## Prerequisites

- A workstation running NetWare Administrator
- The Delete object right to the object that you want to delete



## Procedure

1. **Choose the “NetWare Administrator” icon from the MS Windows Program Manager or the OS/2 desktop.**
2. **Using the browser, select the object you want to delete.**  
  
Only leaf objects and container objects that are empty can be deleted.
3. **Select (check) the “Trustees of This Object” and the “Rights to Other Objects” dialogs.**



If the User object you want to delete has the Supervisor right to another object, give another User object that Supervisor right before you delete the original User object.

4. **Choose “Delete” from the “Object” menu.**



You cannot undo an object deletion. To get the object back, you must re-create it and reenter all data in its properties.

5. **To confirm the deletion, choose “OK.”**

## Additional Information

For more information about	See
Objects	“Object” in <i>Concepts</i>
Rights	“Rights” in <i>Concepts</i>
Using the NetWare Administrator utility	“NetWare Administrator” in <i>Utilities Reference</i>

# Deleting Objects Using NETADMIN

Checklist



## Prerequisites

- A workstation running DOS 3.30 or later and the NETADMIN utility
- The Delete object right to the object that you want to delete from the Directory tree

Procedure



## Procedure

1. **At the DOS prompt, type**

`NETADMIN <Enter>`

For information on moving around in NETADMIN and selecting objects, press <F1> after starting the utility.

2. **Choose “Manage Objects” from the “NETADMIN Options” menu.**
3. **Browse the Directory until the object you want to delete appears.**

Use the instructions at the bottom of the screen to browse the Directory. Press <F1> if you need help.

4. **Select the object and press <Delete>.**

Important



If the User object you want to delete has the Supervisor right to another object, give another User object that Supervisor right before you delete the original User object.

Important



You cannot undo an object deletion. To get the object back, you must re-create it and reenter all data in its properties.

5. **To confirm the deletion, choose “Yes.”**

The object is deleted from the Directory tree.

6. **Press <Esc> until you return to the “NETADMIN Options” menu**



## Additional Information

For more information about	See
Objects	“Object” in <i>Concepts</i>
Rights	“Rights” in <i>Concepts</i>
Using the NETADMIN utility	“NETADMIN” in <i>Utilities Reference</i>

## Renaming Leaf and Container Objects

You may want to rename objects to make their names more descriptive or to reflect your changing environment. For example, you may want to rename a printer from LASER IN BLDG D to LASER IN BLDG A, or an Organizational Unit from SALES to ACCOUNTS.

When you rename an object, Novell Directory Services changes all references to the renamed object.

Renaming a leaf object changes only the object’s common name, which is the name that is displayed in the Directory tree. It does not change the object’s context. However, renaming a container object changes the object’s common name as well as its context.

When renaming a container object, you should seriously consider creating an alias object that points to the container object you’re renaming. Then users can continue logging in to the network and can see the container object’s original name.



If you rename a container object and do not create an alias, users who are unaware of the object’s new name will not easily find the object in the Directory tree, since they will look for its original name.

Also, users may not be able to log in if the name context in their configuration file (NET.CFG file) references the renamed container.

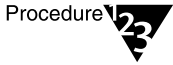
To automatically update users’ NET.CFG file with a new name context after you rename a container object, you can place a command in the renamed container’s log script that will run the NCUPDATE utility.

# Renaming Objects Using NetWare Administrator



## Prerequisites

- A workstation running NetWare Administrator
- The Rename object right to the object that you want to rename



## Procedure

1. **From the MS Windows Program Manager or the OS/2 desktop, choose the “NetWare Administrator” icon.**
2. **Using the browser, select the object that you want to rename.**
3. **From the “Object” menu, choose “Rename.”**
4. **Type the name you want to give to the object you selected.**
5. **(Optional) Select “Save Old Name.”**

Select this option if you want the old name saved as a value in the “Other Names” field of the “Details” screen.

With the old name saved, users who don’t know the object’s new name can search for the object under the old name.

6. **(Optional) If you are renaming a container object, select “Create Alias in Place of Renamed Container.”**



If you don’t create an alias, users who are unaware that the container has been renamed cannot easily find the object in the Directory tree. Also, users whose name context in their NET.CFG file references the renamed container might be unable to log in.

7. **To save the changes and return to the browser, choose “OK.”**

If you renamed a container object, you should use the NCUPDATE utility to update the name context of users in the renamed container. For instructions, see “NCUPDATE” in *Utilities Reference*.

## Additional Information

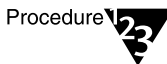
For more information about	See
Objects	“Object” in <i>Concepts</i>
Rights	“Rights” in <i>Concepts</i>
Alias objects	“Alias object” in <i>Concepts</i>
Directory tree	“Directory tree” in <i>Concepts</i>
NCUPDATE	“NCUPDATE” in <i>Utilities Reference</i>
Using the NetWare Administrator utility	“NetWare Administrator” in <i>Utilities Reference</i>

## Renaming Objects Using NETADMIN



### Prerequisites

- A workstation running DOS 3.30 or later and the NETADMIN utility
- The Rename object right to the object that you want to rename



### Procedure

- 1. At the DOS prompt, type**

**NETADMIN** <Enter>

For information on moving around in NETADMIN and selecting objects, press <F1> after starting the utility.

- 2. From the “NETADMIN Options” menu, choose “Manage Objects.”**

Your current context appears in the upper left corner of the screen.

3. **Select the object that you want to rename.**
  - ◆ If the object appears on the list, select it and press <F10>.
  - ◆ If the object is not on the list, browse the Directory by selecting container objects and pressing <Enter> until you see the object you want. Select it and press <F10>.
4. **Choose “Rename.”**
5. **In the “New Name” field, enter a new name for the object.**
6. **Choose “Yes” to save the old name; choose “No” to discard the old name.**

Choose “Yes” if you want the old name saved as a value in the “Other Names” field of the “Details” screen.

With the old name saved, users who do not know the object’s new name can search for the object under the old name.
7. **To save your changes, press <F10>.**
8. **To confirm you want to save the new name, choose “Yes.”**
9. **(Optional) To create an alias in place of the renamed container, choose “Yes.”**



If you don’t create an alias, users who are unaware that the container has been renamed cannot easily find the object in the Directory tree. Also, users whose name context in their NET.CFG file references the renamed container might be unable to log in.

10. **Press <Esc> until you return to the “NETADMIN Options” menu.**

If you renamed a container object, you should use the NCUPDATE utility to update the name context of users in the renamed container. For instructions, see “NCUPDATE” in *Utilities Reference*.

### Additional Information

For more information about	See
Objects	“Object” in <i>Concepts</i>

For more information about	See
Rights	“Rights” in <i>Concepts</i>
Alias objects	“Alias object” in <i>Concepts</i>
NCUPDATE	“NCUPDATE” in <i>Utilities Reference</i>
Using the NETADMIN utility	“NETADMIN” in <i>Utilities Reference</i>

## Changing Object Property Values

You can use the NetWare Administrator or NETADMIN utility to change object property values.

In this section, the general procedures for changing object property values are followed by tables that describe how to change specific properties of specific objects.

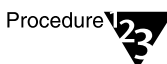
For a complete list of all properties for all objects, see Appendix A, “NDS and Bindery Objects and Properties,” in *Guide to NetWare 4 Networks*.

### Changing Object Property Values Using NetWare Administrator



#### Prerequisites

- A workstation running NetWare Administrator
- The Create object right to the container of the object whose property value will be changed



#### Procedure

1. Choose the “NetWare Administrator” icon from the MS Windows Program Manager or the OS/2 desktop.
2. From the browser, select the object whose property values you want to change.

For information on moving around in the browser and selecting objects, choose the “Help” button.

**3. Choose “Details” from the “Object” menu.**

The “Identification” page appears.

**4. Make any necessary changes.**

See Table 1-7 and Table 1-8 for details on object property values you can change.

Click on “Help” for details on each field and option.

Do not choose “OK” until you have entered all the changes you want to make to every page of the object dialog.

Do not choose “Cancel” unless you want to lose all changes made to every page of the object dialog.

Table 1-7 describes how to change User object property values.

**Table 1-7**

**Changing User Object Property Value with NetWare Administrator**

To	Choose this page of the object dialog; then...
Change the User’s last name, other names, title, description, department, telephone number, fax number, or email address	“Details”; then enter information in the fields.
Disable the User’s account	“Details”; then choose “Login Restrictions,” and select (check) “Account Disabled.”
Change the User’s password	“Details”; then choose “Password Restrictions,” choose “Change Password,” and then enter information in the fields.
Set the User’s account expiration date or number of concurrent connections	“Details”; then choose “Login Restrictions,” check “Account Has Expiration Date” or “Limit Concurrent Connections,” and then enter information in the fields.
Change the User’s password restrictions (password length, periodic changes, uniqueness, grace logins)	“Details”; then choose “Password Restrictions,” and enter information in the fields.
Restrict the User’s login times	“Details”; then choose “Login Time Restrictions,” and choose the days and hours that the User is restricted from logging in to the network.

Table 1-7 *continued*

**Changing User Object Property Value with NetWare Administrator**

To	Choose this page of the object dialog; then...
Set the User's login address restrictions	"Details"; then choose "Network Address," select the appropriate protocol, choose "Add," and then enter information in the fields.
Change the User's login script	"Details"; then choose "Login Script," and enter login script commands.
Specify the User's Profile login script	"Details"; then choose "Login Script," choose the browser button next to the "Profile" field, and then select a new Profile object from the "Select Object" dialog.
Add the User to an existing Group	"Details"; then choose "Group Membership," choose "Add," and then select a Group from the "Select Object" dialog.
Unlock a User's account	"Details"; then choose "Intruder Lockout," and enter information in fields to reset the User's account.
View, reset, or set up intruder detection on a user's account	"Details"; then choose "Intruder Lockout," and view or reset information in fields to detect intruder attempts.  To set up intruder detection, you must go to the "Details" page of the container that the users reside in; then choose "Intruder Detection," and enter information in the fields.
Change a User's mailing address	"Postal Address"; then enter information in the fields.
Set up the User's security equivalences	"Security Equivalence"; then choose "Add," and select an object from the "Select Object" dialog.

Table 1-8 describes how to change other object property values.

**Table 1-8**  
**Changing Other Object Property Values with NetWare Administrator**

To	Select this class of object	Choose this page of the object dialog; then...
Change information about the object's description, location, department, organization, etc.	Any class	"Details"; then enter information in the fields.
Change the object's mailing address	Organization, Organizational Unit	"Details"; then choose "Postal Address," and enter information in the fields.
Change the object's login script	Organization, Organizational Unit, Profile	"Details"; then choose "Login Script," and enter login script commands.
View, reset, or set up intruder detection for the object	Organization, Organizational Unit	"Details"; then choose "Intruder Detection," and enter information in the fields to detect intruder attempts.
Change the list of operators or resources associated with this object	AFP Server, Computer, NetWare Server	"Details"; then choose "Operators," "Supported Services," "Resources," or "User"; click on "Add," and then select other objects from the "Select Object" dialog.
Set the object's network address and protocol	AFP Server, Computer, NetWare Server, Volume	"Details"; then choose "Network Addresses"; select a network protocol, choose "Add," and then complete the fields associated with that protocol.
Change the list of other objects affiliated with this object	Any class	"Details"; then choose "See Also," choose "Add," and then select other objects from the "Select Object" dialog.
Change the list of objects belonging to the Group	Group	"Details"; then choose "Members," choose "Add," and then select other objects from the "Select Object" dialog.



Table 1-8 *continued*

**Changing Other Object Property Values with NetWare Administrator**

To	Select this class of object	Choose this page of the object dialog; then...
Change the object's volume time or usage information	Volume	"Details"; then choose "Statistics," "Dates and Times," or "User Space Limits"; then enter information in the fields.

- To save the changes you made in all pages of the dialog, and return to the browser, choose "OK."**

**Additional Information**

For more information about	See
Objects	"Object" in <i>Concepts</i>
Object properties	"Property" in <i>Concepts</i>
Rights	"Rights" in <i>Concepts</i>
Using the NetWare Administrator utility	"NetWare Administrator" in <i>Utilities Reference</i>

**Changing Object Property Values Using NETADMIN**



**Prerequisites**

- A workstation running DOS 3.30 or later
- The Create object right to the container of the object whose property value will be changed

## Procedure

1. **At the DOS prompt, type**

`NETADMIN` <Enter>

For information on moving around in NETADMIN and selecting objects, press <F1> after starting the utility.

2. **Choose “Manage Objects” from the “NETADMIN Options” menu.**

3. **Browse the Directory until the object you want appears.**

Use the instructions at the bottom of the screen to browse the Directory. Press <F1> if you need help.

4. **Select the object and press <F10>.**

The “Actions” dialog appears.

5. **Choose “View or Edit Properties of This Object.”**

6. **Select an option and make any necessary changes.**

See Table 1-9 and Table 1-10 for details on object property values you can change.

Press <F1> for details on each field and option.

Table 1-9 describes how to modify User object property values.

**Table 1-9**

**Changing User Object Property Values with NETADMIN**

To	Choose this option from the “View or Edit Properties of This Object” menu; then...
Change the User’s last name, other names, title, description, location, department, telephone number, fax number, or E-mail address	“Identification”; enter information in the fields.
Disable the User’s account	“Account restrictions,” and then choose “Login restrictions”; enter “Yes” in the “Account disabled” field.
Change the User’s password	“Change password”; enter new password as prompted.
Set the User’s account expiration date or number of concurrent connections	“Account restrictions,” and then choose “Login restrictions”; enter information in the fields.
Change the User’s password restrictions (password length, changes, uniqueness, grace logins)	“Account restrictions,” and then choose “Password restrictions”; enter information in the fields.
View, reset, or set up intruder detection on a user’s account	<p>“Account restrictions,” and then choose “Intruder lockout status”; view or reset information in fields to detect intruder attempts.</p> <p>To set up intruder detection, you must go to the “View or Edit Properties of This Object” page of the container that the users reside in; then choose “Intruder Detection,” enter information in the fields.</p>
Restrict the User’s login times	“Account restrictions,” and then choose “Login time restrictions”; enter information in the fields.
Change the User’s login script	“Login script”; enter login script commands.
Set the User’s login address restrictions	“Account restrictions,” and then choose “Net address restrictions”; press <Insert>, select the address type, and then enter information in the fields.
Specify the User’s Profile login script	“Groups/Security Equal To/Profile”; choose “Profile,” and then enter the name and context of the Profile object (or press <Insert> and select the name from the list).

Table 1-9 *continued*

### Changing User Object Property Values with NETADMIN

To	Choose this option from the “View or Edit Properties of This Object” menu; then...
Add the User to an existing Group.	“Groups/Security Equal To/Profile”; select “Groups” and press <Enter>, and then press <Insert> and enter the Group name (or press <Insert> again and select the Group name from the list).
Give the User security equivalence to another User.	“Groups/Security Equal To/Profile”; select “Security Equal To” and press <Enter>, and then press <Insert> and enter the complete name (or press <Insert> again and select the name from the list).
Change the User’s mailing address.	“Postal address”; enter information in the fields.
Change the User’s account balance, credit, or allow unlimited balance.	“Account restrictions,” and then choose “Account balance”; enter information in the fields.
Change the list of other objects affiliated with this User object.	“See also”; enter names (or press <Insert> and select names from the list).

Table 1-10 describes how to modify other object property values.

Table 1-10

### Changing Other Object Property Values With NETADMIN

To	Select this class of object	Choose this option from the “View or edit properties of this object” menu; then...
Change the information about an object’s description, location, department, organization, etc.	Any class except Print Queue, Print Server, Printer	“Identification”; enter information in the fields.
Change information about the object’s mailing address	Organization, Organizational Role, Organizational Unit	“Postal address”; enter information in the fields.
Change the object’s login script	Organization, Organizational Unit, Profile	“Login script”; enter login script commands.
Change the object’s password	AFP Server	“Change password”; enter a new password.

Table 1-10 *continued*

**Changing Other Object Property Values With NETADMIN**

To	Select this class of object	Choose this option from the “View or edit properties of this object” menu; then...
Set up the object’s accounting information	NetWare Server	“Accounting,” and then choose “Submenus”; enter information in the fields.
Set up the object’s intruder detection lockout	Organization, Organizational Unit	“Intruder detection”; enter information in the fields.
Set the object’s network address and protocol	Computer	“Other properties,” and then choose “Network address” and press <Enter>; press <Insert> and select an address type, and then enter information in other fields.
Change the list of other objects affiliated with this object	Any class except Print Queue, Print Server, Printer, User	“See also”; enter names of objects (or press <Insert> and select names from the list).
Change the list of objects belonging to the Group	Group	“Group members”; enter names of objects (or press <Insert> and select names from the list).
View the object’s volume time or usage information	Volume	“Volume statistics,” “Volume restrictions,” “Volume features,” or “Volume dates/times”; enter information in the fields.

7. **To save your changes, press <F10>.**
8. **Press <Esc> until you return to the “NETADMIN Options” menu.**

## Additional Information

---

For more information about	See
Objects	“Object” in <i>Concepts</i>
Object properties	“Property” in <i>Concepts</i>
Rights	“Rights” in <i>Concepts</i>
Using the NETADMIN utility	“NETADMIN” in <i>Utilities Reference</i>

---

# 2 *Managing Directories, Files, and Applications*

This chapter gives you step-by-step procedures for setting up your network file system and giving users access to the resources they need, while still keeping the files secure.

## Planning Directory Structures

How can you design your file system to make network administration easiest? This section gives you some basic information and suggestions about organizing directories and files. See also “Suggestions for Creating Volumes” in Chapter 3 of *Installation*.

### System-Created Directories

During installation, the following directories are automatically created.

- ◆ **SYS:DELETED.SAV** contains the files that are deleted before they are purged.
- ◆ **SYS:ETC** contains sample files to help you configure the server.
- ◆ **SYS:LOGIN** contains the programs necessary for users to log in to the network, such as LOGIN.EXE. It has a special subdirectory for OS/2 login programs and a subdirectory called NLS, containing subdirectories for each supported language for login message files.
- ◆ **SYS:MAIL** may or may not contain subdirectories or files.

If you upgrade your server from a previous version of the NetWare<sup>®</sup> operating system, existing users will still have directories here for their login scripts, but their login scripts will become properties of the new User objects.

If you create new users after upgrading, the new users won't have directories in SYS:MAIL.

**SYS:SYSTEM** contains NetWare operating system files as well as NetWare utilities and programs for the supervisor. SYS:SYSTEM also has an NLS subdirectory, containing subdirectories for each supported language for message files.

**SYS:PUBLIC** allows general access to the network and contains NetWare utilities and programs for network users. Like SYS:LOGIN, SYS:PUBLIC has a special subdirectory for OS/2 utilities and a subdirectory called NLS, containing the message files for utilities.

**SYS:DOC** contains electronic versions of the NetWare manuals. This directory is created if you install DynaText.\*

## High Capacity Storage System (HCSS) Directories

You can create HCSS directories specifically to contain files that migrate to optical disk. Migration begins when allocated space on the hard disk is filled to a set capacity. This feature can be used in place of or in conjunction with file compression and disk suballocation to manage volume space on a server.

HCSS directories can contain DOS program files, applications, batch files, and data files. In HCSS, directories and files are moved back and forth between hard disk and optical disk to optimize the server's storage capacity.

For more information about HCSS directories, see Chapter 6, "Migrating Data Using the High Capacity Storage System," on page 351. See also "High Capacity Storage System" in *Concepts*.

## Workstation Operating System Directories

You may want to put the workstation operating system files on the network to save workstation disk space or to make diskless workstations possible.

Since the workstation operating system files don't normally change, you can keep them on one set of backup diskettes and then skip these directories when you do network backups.



For information about loading operating system software on a network, see “Loading Operating Systems and Applications onto the Network” on page 109.

## **Application Directories**

For ease of management, you should keep application files in a different directory than data files.

Since the application programs don't normally change, you can keep one set of application files on backup diskettes and then skip the application directories when you do network backups.

For more information about loading applications on the network, see “Loading Operating Systems and Applications onto the Network” on page 109.

When creating application directories, you should also consider issues related to ease of distribution, installation, and operational control for network applications. NetWare 4.11 provides the NetWare Application Manager™ (NAM™) software to assist you in setting up and managing network applications through Novell® Directory Services™ from a single administrative console.

For more information about using NAM to manage applications, see “Setting Up and Using NetWare Application Management Software” on page 123.

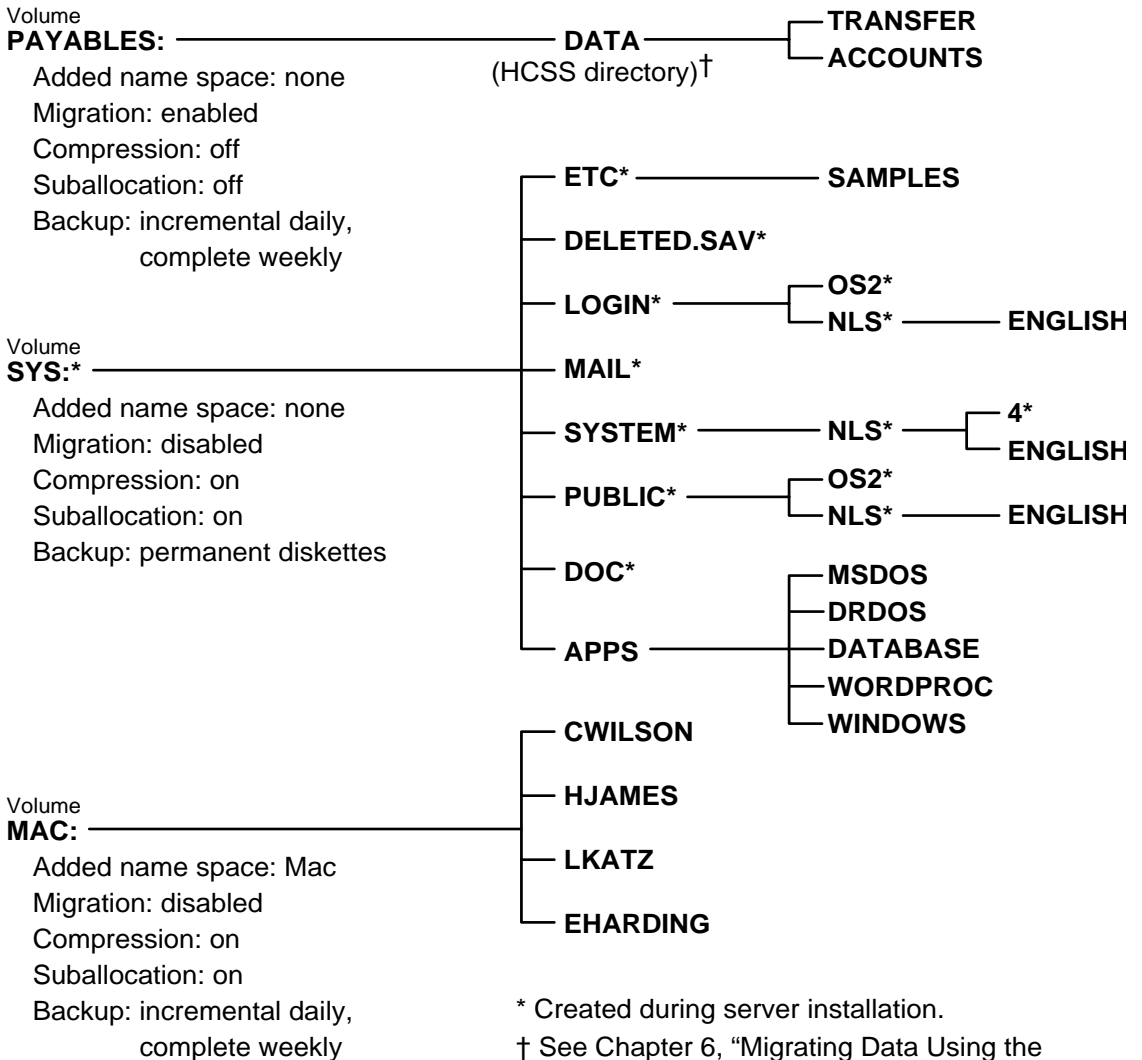
## **Data Directories**

Data directories can include work areas where groups or users keep work files. You can also create a directory to serve as a transfer point for copying files to and from other areas of the network.

## **Sample Directory Structure**

A sample directory structure is shown in Figure 2-1.

**Figure 2-1**  
**Sample Network Directory Structure**



## Creating Directories and Copying Files

For each NetWare volume, you can create directories and subdirectories to organize data and applications. (If you haven't created the volume, see "Maintaining Volumes" on page 468.)

Use one of several tools to divide a NetWare volume into directories. For example, use the NetWare Administrator graphical utility or the FILER text utility.

Two methods of creating directories and copying files (NetWare Administrator and FILER) are documented in this section.

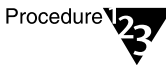
## Creating Directories Using NetWare Administrator

### Prerequisites



- A 386 or 486 workstation running NetWare Administrator
- The Create right to the parent directory of the new directory

### Procedure



1. **Choose the “NetWare Administrator” icon from the Microsoft Windows (MS Windows) Program Manager or the OS/2 desktop.**
2. **Using the browser, select the directory to be the parent directory of the one you want to create.**

To create a root directory, select the Volume object. For more about moving around in the browser and selecting objects, choose “Help” from the menu bar. For a list of directories and files on a volume, select “View/Set Context” and specify the volume name.

3. **Choose “Create” from the “Object” menu.**
4. **Enter the name for the new directory in the “Directory Name” box.**

5. **(Optional) Choose “Define Additional Properties” if you want to enter properties for the directory.**

Choose this item if you want to assign properties to the new directory now. You can also add or modify properties after the directory is created. Properties include items such as trustees and access rights.

6. **(Optional) Choose “Create Another Directory” to create another directory immediately after this one.**

7. **Choose “Create” to create a directory with the name you entered.**

The new directory is created. You are returned to the browser.

### Additional Information

For more information about	See
Creating HCSS directories	“Setting Up the HCSS File System” on page 369
Directories for workstation operating systems	“File system” in <i>Concepts</i>
File system rights	“Attributes,” “Effective rights,” “Inherited Rights Filter,” “Rights,” and “Security” in <i>Concepts</i>
Assigning directory and file rights	“Making the File System Secure and Accessible” on page 133
Using the NetWare Administrator utility	“NetWare Administrator” in <i>Utilities Reference</i>

# Creating Directories Using FILER

Checklist



## Prerequisites

- A workstation running DOS 3.30 or later
- A minimum of 512 KB of memory available on the workstation
- The Create right to the parent directory of the new directory

Procedure



## Procedure

### 1. At the DOS prompt, type

**FILER** <Enter>

A list of available options appears.

Your current context, Volume object, and path are shown in the upper left corner of the screen. Make sure you are in the correct location in the Directory tree when you create the new directory.

### 2. Select “Manage Files and Directories.”

The “Directory Contents” list appears.

### 3. Find and select the volume, directory, or subdirectory in which you want to create a new directory or subdirectory by completing the following steps:

- ◆ If the item you want appears on the list, select it and press <Insert>.
- ◆ If the item is not on the list, browse a directory or subdirectory by selecting it and pressing <Enter> until you see the item you want. Select it and press <Insert>.
- ◆ If you can't find what you want, check the Volume object name in the upper left corner of the screen. If you are in the wrong volume, you can change it by returning to the “Available Options” menu and choosing “Select Current Directory.”

4. **When you are prompted, type the name of the new directory and press <Enter>.**

The new directory is created. After you create it, you can change default attributes, assign rights, and make trustee assignments for the directory or subdirectory.

5. **To exit, press <Esc> until the menu you want appears.**

### Additional Information

For more information about	See
Assigning directory and file rights	"Making the File System Secure and Accessible" on page 133
File system rights	"Understanding File and Directory Rights" on page 133  "Attributes," "Effective rights," "Inherited Rights Filter," "Rights," and "Security" in <i>Concepts</i>  "Adding a Trustee to a Directory or File" on page 136
Using the FILER utility	"FILER" in <i>Utilities Reference</i>

## Copying or Moving Files Using NetWare Administrator

If you use the NetWare Administrator to copy a Macintosh file between volumes, you lose extended attribute information on the file unless the two volumes have identical sets of name spaces loaded.

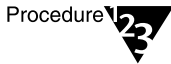
For example, if volume 1 has MAC and DOS name spaces, and volume 2 has MAC, DOS, and OS/2, and you copy a Macintosh file from one volume to another, you lose extended attributes even though both volumes have the MAC name space.



## Prerequisites

- A 386 or 486 workstation running NetWare Administrator.
- The File Scan right to the source directory and the Create right to the destination directory. In addition, to move files (delete them from the source directory), you need the Erase right.

## Procedure



1. **Choose the “NetWare Administrator” icon from the MS Windows Program Manager or the OS/2 desktop.**
2. **Using the browser, select the directory, and then select one or more files in that directory that you want to copy or move.**

To select multiple files, press <Ctrl> on the keyboard while clicking on the files.

For information about moving around in the browser and selecting objects, choose “Help” from the menu bar.

3. **Choose “Move” or “Copy” from the “Object” menu.**  
A list appears of the files you selected.
4. **Select either “Move” or “Copy” from the “Operation” dialog.**
5. **Choose the browser button next to the “Destination” field.**
6. **Using the browser, select a directory in a volume for the destination of the directories or files.**
7. **Choose “OK.”**  
The destination directory is listed in the “Destination” field.
8. **Choose “OK.”**  
The listed files are copied or moved to the destination directory.

## Additional Information

---

For more information about	See
----------------------------	-----

---

File system directories and files	“File system” in <i>Concepts</i>
-----------------------------------	----------------------------------

---

For more information about	See
File system rights	“Understanding File and Directory Rights” on page 133  “Attributes,” “Effective rights,” “Inherited Rights Filter,” “Rights,” and “Security” in <i>Concepts</i>
Using the NetWare Administrator utility	“NetWare Administrator” in <i>Utilities Reference</i>

## Copying or Moving Files Using FILER

Checklist



### Prerequisites

- A workstation running DOS 3.30 or later.
- A minimum of 512 KB of memory available on the workstation.
- The File Scan right to the source directory and the Create right to the destination directory. In addition, to move files (delete them from the source directory), you need the Erase right.

Procedure



### Procedure

1. **At the DOS prompt, type**

**FILER** <Enter>

A list of available options appears.

Your current context, volume object, and path are shown in the upper left corner of the screen.

2. **Select “Manage Files and Directories.”**

The “Directory Contents” list appears.

3. **Find the volume, directory, or subdirectory that contains the source files.**

Browse the directory structure by selecting a directory or subdirectory and pressing <Enter> until you see the directory or files you want to copy.



If you can't find the directory or files you want, check the Volume object name in the upper left corner of the screen. If you are in the wrong volume, you can change it by returning to the "Available Options" menu and choosing "Select Current Directory."

Depending on the operation you want to perform next, go to either Step 4 or Step 5.

4. **(Optional) If you want to move or copy a directory or subdirectory and all its contents, complete the following steps:**
  - 4a. **Select the directory or subdirectory and press <F10>.**
  - 4b. **Select the option you want from the "Subdirectory Options" menu.**
  - 4c. **At the prompt, type in the complete path to the destination directory, or press <Insert> to browse for the destination directory.**
  - 4d. **Press <F10> to start the copy or move process.**

The progress of the transaction is shown in an information box.
  
5. **(Optional) To copy specific files, complete the following steps:**
  - 5a. **Select the directory or subdirectory containing the files and press <Enter>.**

**5b. Press <F5> to mark files you want to copy.**

Browse the directory structure by selecting a directory or subdirectory and pressing <Enter> until you see the directory or files you want to copy.

If you can't find the directory or files you want, check the Volume object name in the upper left corner of the screen. If you are in the wrong volume, you can change it by returning to the "Available Options" menu and choosing "Select Current Directory."

**5c. After all of the files are marked, press <F10>.**

**5d. From the "Multiple File Operations" menu, select "Copy Marked Files."**

The "Copy Files to" box appears.

**5e. Type in the complete path to the destination directory or press <Insert> to browse for the destination directory.**

**5f. Press <F10> to start copying the files.**

The progress of the transaction is shown.

**6. To exit, press <Esc> until the menu you want appears.**

**Additional Information**

<b>For more information about</b>	<b>See</b>
Creating HCSS directories	"Setting Up the HCSS File System" on page 369
Directories and files	"File system" in <i>Concepts</i>
File system rights	"Understanding File and Directory Rights" on page 133 "Attributes," "Effective rights," "Inherited Rights Filter," "Rights," and "Security" in <i>Concepts</i>
Using the FILER utility	"FILER" in <i>Utilities Reference</i>

# Loading Operating Systems and Applications onto the Network

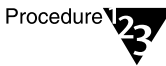
You may want to load workstation operating system (OS) files onto the network to save workstation disk space or to allow diskless workstations to log in to the network.

## Loading DOS onto the Network



### Prerequisites

- A workstation running DOS 3.30 or later
- The Supervisor or Create right to the directory where you want to load the application



### Procedure

1. **Create a directory in SYS:PUBLIC for each workstation type and version of DOS you will be using on your network.**

Name your directories according to the following convention:

**SYS:PUBLIC/machine/os\_type/os\_version**

For each directory, replace machine with the six-letter machine name of the workstation (such as IBM\_PC or COMPAQ).

Replace os\_type with the type of DOS you are using (such as MSDOS or DRDOS). Replace os\_version with the DOS version number.

For example, to install MS-DOS\* 5.0 on an IBM PC, go to SYS:PUBLIC to create the DOS subdirectory. To use the DOS MD command, type the commands shown below (in order):

```
MD IBM_PC <Enter>
CD IBM_PC <Enter>
MD MSDOS <Enter>
CD MSDOS <Enter>
MD 50 <Enter>
CD 50 <Enter>
```

## 2. Load DOS.

Follow the instructions in the DOS documentation to load the DOS software into the directories you created.

## 3. In the system login script, map the second search drive to the DOS directory.

If all users have the same types of workstations and are using the same version of DOS, you will probably have only one DOS directory. In this case, add a line similar to the following, substituting the correct directory names:

```
MAP S2:=SYS:PUBLIC\IBM_PC\MSDOS\50
```

If your network has more than one DOS directory, use variables to indicate the directory path. These variables are replaced by the correct information from the workstation software when each user logs in. Enter the following command, exactly as shown, in the login script:

```
MAP S2:=SYS:PUBLIC\%MACHINE%\OS\OS_VERSION
```

(The first search drive should be mapped to the PUBLIC directory so that users can access NetWare utilities.) For the %MACHINE variable to work, make sure the long machine type is set in each station's NET.CFG file. For example, a station might have the following line in its NET.CFG file:

```
LONG MACHINE TYPE = IBM_PC
```

## 4. Add COMSPEC to the system login script.

Following is the proper syntax for the COMSPEC command:

```
COMSPEC=Y:COMMAND.COM
```

This command tells the workstation where to find the command processor.

## Additional Information

---

For more information about	See
Loading DOS on the network	The DOS manual that came with your software
Login scripts	Chapter 3, "Creating Login Scripts," on page 169
Mapping search drives	"Mapping Search Drives" on page 214
Running DOS on a workstation	<i>NetWare Client for DOS and Windows User Guide</i>

---

## Loading MS Windows onto the Network

You can load MS Windows onto a network in several ways:

- ◆ Load all MS Windows files on a user's local hard drive.
- ◆ Load MS Windows program files on the server, and load user files on local hard drives.
- ◆ Load all MS Windows program and user files on the server. In most cases, this installation provides the easiest maintenance and most efficient use of resources.

Instructions for the first two options are included in the documentation that came with your MS Windows software. Instructions for loading program and user files on the server are included in this section.

Following are some advantages of having all MS Windows files installed on the server:

- ◆ Program and configuration files are backed up and secure.
- ◆ No hard disk is required on the user workstation.
- ◆ The .INI and driver files for all users can be updated from one location.
- ◆ Configuration files always match hardware.

The only real disadvantage of having all MS Windows files installed on the server is that it causes more network traffic.

### Files Needed for NetWare Functionality in MS Windows

Use the following files to run MS Windows with NetWare functionality. These files are in the Workstation for DOS/Windows kit.

File	Function
NETWARE.DRV	NetWare device driver. Contains executable code for NetWare-related functions.
NETWARE.HLP	Help file for NETWARE.DRV.
NETWARE.INI	Initialization file for NETWARE.DRV and other MS Windows utilities for NetWare. Automatically created by NETWARE.DRV.
NWPOPOP.EXE	Handler for broadcast messages.
VNETWARE.386	Virtual NetWare device driver. Performs virtualization among sessions when MS Windows is in 386 Enhanced mode.
VIPX.386	Virtual IPX device driver. Virtualizes IPX communications among sessions when MS Windows is in 386 Enhanced mode.

## Guidelines for Running MS Windows on the Network

- ◆ Use a permanent swap file on a local hard drive if possible; do not use network directories for swap files. If a local swap file is not possible, consider increasing RAM to a minimum of 8 MB.
- ◆ RAM plus swap file size should be a minimum of 10 MB.
- ◆ Remove MS Windows search drives from the workstation AUTOEXEC.BAT file.
- ◆ If users are running DR DOS, make sure DR DOS files are dated 07 April 1992 or later.
- ◆ If users are running DR DOS, make sure their CONFIG.SYS files install EMM386.SYS and configure it for use with MS Windows. See your DR DOS manual or DR DOS online help for configuration information.

## Loading and Setting Up MS Windows

Checklist



### Prerequisites

- A workstation running DOS 3.30 or later
- The Supervisor or Create right to the directory where you are loading MS Windows
- A licensed network copy of MS Windows 3.1 or later
- 16 MB of available disk space
- NetWare Client for DOS and MS Windows

## Procedure

- 1. Install MS Windows server software, using the SETUP /A option.**

For complete information about the MS Windows SETUP options and the installation procedure, see the documentation that came with your MS Windows software.

- 2. Create a Group object for users who will be running MS Windows.**

For instructions for creating a Group object, see “Managing Group Objects” on page 41.

- 3. Make the MS Windows Group object a trustee of the MS Windows directory.**

For instructions on granting trustee assignments, see “Adding a Trustee to a Directory or File” on page 136.

- 4. Create a directory for each user to store user-specific MS Windows files.**

WIN.COM and files such as .GRP and .INI files are stored here.

- 5. Add the following information to the system login script.**

An example of the syntax for these login script entries appears at the end of this step.

- 5a. Map a drive to the user-specific directories for the MS Windows group.**
- 5b. Map a search drive to the MS Windows directory for the MS Windows Group object.**
- 5c. Set the MS Windows TEMP directory to a subdirectory of the user directory.**



The following example shows the system login script entries you would add to set up MS Windows 3.1 on the network:

```
IF MEMBER OF "WIN31" THEN
MAP INS P:=SYS:USERS\%LOGIN_NAME\WIN31
MAP INS S16:=SYS:APPS\WINAPPS\WIN31
SET TEMP = "P:\USERS\%LOGIN_NAME\WIN31\TEMP"
END
```

6. **Set up the workstations by completing the following steps.**
  - 6a. **Change to the search drive mapped to the MS Windows directory.**

Enter the drive letter only.

- 6b. **Modify the user AUTOEXEC.BAT and CONFIG.SYS files by typing:**

```
SETUP /N <Enter>
```

Select the "Custom" option to make sure environment variables are correct. When MS Windows prompts for a path during setup, enter the drive letter instead of the path.

- 6c. **Install the NetWare Workstation for MS Windows software.**

Follow the instructions in *NetWare Client for DOS and Windows User Guide* to install the workstation software and update NetWare-specific files in the MS Windows directory.

### Additional Information

For more information about	See
Creating login scripts	Chapter 3, "Creating Login Scripts," on page 169
Installing MS Windows on the network	The MS Windows manual that came with your software
Mapping search drives	"Mapping Search Drives" on page 214
Running MS Windows on a workstation	<i>NetWare Client for DOS and Windows User Guide</i>

## Loading Other Applications onto the Network

You can load various types of network applications, such as word processing or spreadsheet programs, to make them available to users. When loading applications, keep the following in mind:

- ◆ You need the Create right in the directory where you will be loading the application.
- ◆ Follow the instructions in the application's documentation for loading the application onto a network.
- ◆ Make sure the application is designed for network (multiuser) use, and that you observe any licensing restrictions on the number of users who can access the application.
- ◆ To allow users to access network-based applications, map search drives to the directories that contain these applications. To make these search drives permanent, place them in login scripts, which are executed when users log in.
- ◆ If the application requires that it be installed at the root of a volume, but you would rather install it in a subdirectory for security reasons, you can map the directory to a fake root. To map a fake root directory, use the MAP ROOT command as explained in "MAP" on page 210.
- ◆ You can create a Directory Map object that points to an application directory.

Directory Map objects are useful in login scripts. Instead of mapping a drive to a specific directory path, you map a drive to a Directory Map object that points to a directory.

Then, if you change the directory path, you need to change only the Directory Map object's definition.

### Additional Information

For more information about	See
Creating login scripts	Chapter 3, "Creating Login Scripts," on page 169

For more information about	See
Mapping search drives and fake roots in login scripts	“MAP” on page 210

## Assigning Trustee Rights to Operating System and Application Directories

Application programs need a set of file system rights that make them available to users, yet protect them from being corrupted. Keep the following guidelines in mind as you assign file and directory rights to executable, application, and program files.

When you are ready to assign file and directory attributes and rights, see “Making the File System Secure and Accessible” on page 133.

Use the FLAG utility to assign the following rights:

- ◆ Assign the Shareable and Read-Only attributes to application and workstation operating system files.
- ◆ Assign the Execute Only attribute to executable files for which you keep permanent backups.
- ◆ Assign Read and File Scan rights to the User or Group objects that need to use the application.

### Additional Information

For more information about	See
Understanding file system rights	“Effective rights” and “Rights” in <i>Concepts</i>
Assigning file and directory rights	“Changing Attributes of a Directory or File” on page 148
Using the FLAG utility	“FLAG” in <i>Utilities Reference</i>

# Creating and Using Directory Map Objects

## How to Use Directory Map Objects

A Directory Map object represents a particular directory in the file system.

Directory Map objects can be especially useful in login scripts by indicating directories that contain applications or other frequently used files.

For example, if you have a directory that contains DOS 5.0, you will probably map a search drive to that directory in any login scripts you create.

If you should later upgrade to DOS 6.0 and rename the directory, you would have to change the mapping in every login script where that search mapping appears.

By using a Directory Map object, you could avoid having to make changes to the login scripts.

First, you could create a Directory Map object called `CURRENT_DOS` that points to the DOS directory (`SYS:PUBLIC\IBM_PC\MSDOS\5.0`).

Then, in a `MAP` command in your login scripts, map a search drive to the Directory Map object, rather than to the specific directory:

```
MAP INS S2:=-.CURRENT_DOS.SALES.NOVELL_US
```

When users log in, their search drive is mapped to the `CURRENT_DOS` Directory Map object, which points to the directory containing DOS 5.0.

Later, if you upgrade to DOS 6.0 and change the directory's name to `SYS:PUBLIC\IBM_PC\MSDOS\60`, you would change only the Directory Map object to indicate the new path.

You would not have to change the `MAP` command in the login script because the `MAP` command still indicates the correct Directory Map object.

## Additional Information

For more information about	See
Creating login scripts	Chapter 3, "Creating Login Scripts," on page 169
Mapping drives to Directory Map objects in login scripts	"MAP" on page 210
Using the MAP utility	"MAP" in <i>Utilities Reference</i>

## Creating a Directory Map Object

You can create a Directory Map object using either the NetWare Administrator graphical utility or the NETADMIN text utility. Both procedures are documented in this section.

### Using NetWare Administrator to Create a Directory Map Object



#### Prerequisites

- A 386 or 486 workstation running NetWare Administrator
- The Create object right to the container where the Directory Map object will be created

## Procedure

1. Choose the “NetWare Administrator” icon from the MS Windows Program Manager or the OS/2 desktop.
2. From the browser, select the Organization or Organizational Unit object that will contain the Directory Map object.

For information about moving around in the browser and selecting objects, choose “Help” from the menu bar.

3. Choose “Create” from the “Object” menu.
4. Choose “Directory Map” from the “New Object” dialog box.
5. Choose “OK.”
6. Enter the name for the Directory Map object in the space provided.
7. In the “Volume” field, enter the name of the volume this Directory Map object will point to.

You can type in the complete name of the Volume object, or you can choose the browser button to the right of the “Volume” field to browse for the Volume object.

8. In the “Path” field, enter the path of the directory this Directory Map object will point to.

You can type in the path, or you can choose the browser button to the right of the “Path” field to browse for the directory that the Directory Map object will point to.

If the Directory Map object will point to the root of the specified volume, leave the “Path” field blank.

9. (Optional) To define additional properties immediately after creating the Directory Map object, choose “Define Additional Properties.”
10. (Optional) To create another Directory Map object immediately after this one, choose “Create Another Directory Map.”

## 11. Choose “Create.”

The Directory Map object is created

If you chose “Create Another Directory Map,” the Create dialog appears.

If you chose “Define Additional Properties,” the identification screen appears.

### Additional Information

For more information about	See
Directory Map objects	“Directory Map object” in <i>Concepts</i>
Using the NetWare Administrator utility	“NetWare Administrator” in <i>Utilities Reference</i>

## Using NETADMIN to Create a Directory Map Object



### Prerequisites

- A workstation running DOS 3.30 or later
- A minimum of 512 KB of memory available on the workstation
- The Create object right in the container where the Directory Map object will be created



### Procedure

1. **At the DOS prompt, type**  
`NETADMIN <Enter>`
2. **Choose “Manage Objects” from the “Netadmin Options” menu.**

- 3. Select the Organization or Organizational Unit object that will contain the Directory Map object.**

Browse the Directory tree by selecting objects and pressing <Enter>. When you find the object that you want to contain the Directory Map object, select it and then press <Enter>.

- 4. Press <Insert>.**

- 5. From the “Select an Object Class” menu, select “Directory Map.”**

- 6. Type the name for the Directory Map object and press <Enter>.**

- 7. In the “Volume Object Name” field, press <Insert>.**

- 8. Enter the name of the Volume object this Directory Map object will point to.**

You can either type the Volume object’s complete name or you can press <Insert> to browse through the Directory tree, select an object, and press <Enter>.

- 9. In the “Path on Volume” field, press <Insert>.**

- 10. Enter the path of the directory this Directory Map object will point to.**

You can either type the full path or you can press <Insert> to browse the file system directory structure in the volume defined in Steps 7 and 8; then press <Enter>.

If the Directory Map object will point to the root of the specified volume, leave the “Path” field blank and press <Enter>.

- 11. From the “Name Spaces” box, select the type of name space for the volume and press <Enter>.**

- 12. To save the changes, press <F10>.**



## Additional Information

For more information about	See
Directory Map objects	“Directory Map object” in <i>Concepts</i>
Using the NETADMIN utility	“NETADMIN” in <i>Utilities Reference</i>

# Setting Up and Using NetWare Application Management Software

NetWare 4.11 provides application management software that assists you in setting up and managing network applications from a single administrative console through Novell Directory Services.

The software is comprised of a NetWare Administrator tool referred to as NetWare Application Manager™ (NAM) and a client tool referred to as NetWare Application Launcher™ (NAL).

The NetWare application management tools enable management of the application life-cycle, beginning with distribution and installation to configuration and upgrades.

## Setting Up NetWare Application Manager

NetWare Application Manager (NAM) is installed by default into the NetWare Administrator utility. NAM consists of an Application object and the management tools to setup and configure Application objects in the Directory tree.

Application objects allows you to define unique properties for specific applications to be used by the NetWare Application Launcher (NAL) on client workstations. Object properties such as name, location of executable, and support contacts are assigned to each Application object.

In addition, you can also specify unique drive mappings, printer ports, or environment variables that are required by an application.

If you need to reinstall NAM to include it in the NetWare Administrator “Tools” menu, see:

- ◆ “Setting Up NetWare Application Manager for the Windows 3.1x NetWare Administrator” on page 124
- ◆ “Setting Up NetWare Application Manager for the Windows 95 NetWare Administrator” on page 124

### Setting Up NetWare Application Manager for the Windows 3.1 x NetWare Administrator

To configure NetWare Application Manager to run as a tool that can be accessed from NetWare Administrator “Tools” menu, you must edit the NWADMN3X.INI file in the WINDOWS directory.

Add the following lines to the file:

```
[Snapin Object DLLs]
APPSNP3X.DLL = APPSNP3X.DLL
```

### Setting Up NetWare Application Manager for the Windows 95 NetWare Administrator

To configure NetWare Application Manager to run as a tool that can be accessed from NetWare Administrator “Tools” menu, you must edit your system registry after having run the 32-bit NetWare Administrator utility at least once.

#### Procedure

To edit the system registry, complete the following steps.



1. **Run the registry editor by typing**

```
REGEDIT <Enter>
```

2. **Select the following path:**

```
HKEY_CURRENT_USER\Software\NetWare\Parameters\NetWare Administrator
```

3. **With “NetWare Administrator” highlighted, from the “Edit” menu, choose “New” and then “Key.”**

4. **Type**

```
Snapin Object DLLs <Enter>
```

5. With “Snapin Object DLLs” highlighted, from the “Edit” menu, choose “New” and then “String Value.”
6. Type APPSNP95.DLL in the “String Data” field.
7. With “APPSNP95.DLL” highlighted, from the “Edit” menu, choose “Modify.”
8. Type APPSNP95.DLL in the “Value Data” field.
9. Choose “OK.”

## Setting Up NetWare Application Launcher

The NetWare Application Launcher (NAL) allows users to run applications that were previously configured by a network administrator, and whose setup information is stored as an Application object in the Directory tree.

NAL displays icons for all available applications in a window, and lets the user select an icon to launch an application.

Users don't need to worry about drive mappings, paths, or rights—these are all managed by the network administrator. The administrator can manage the Application Launcher by container, Group, or User object.

### Prerequisites for Setting up NetWare Application Launcher



- A workstation logged in to the network, running DOS 3.30 or later, Windows 3.1 or later, or Windows 95\*
  - A minimum of 512 KB of memory available on the workstation
  - The NetWare Application Manager installed in NetWare Administrator
- This occurs by default in NetWare 4.11.
- The NetWare Application Launcher software installed to SYS:PUBLIC

The NALW31.EXE file exists in SYS:PUBLIC and the NALW95.EXE file exists in SYS:PUBLIC\WIN95 directories.

## Setting up NetWare Application Launcher on a Windows 3.1 x Workstation

To configure NetWare Application Launcher (NAL) to run on a user's desktop, you must perform the following procedure.

### Prerequisites



- A workstation cabled to the network and running Windows 3.1 x
- A drive mapping to SYS:PUBLIC on your preferred server
- Authentication to a Novell Directory tree

### Procedure



1. In Program Manager, choose the "NetWare Tools" program group or another program group you want to start NetWare Application Launcher from.
2. From the Program Manager "File" menu, choose "New."
3. Select "Program Item" and choose "OK."
4. Enter "NetWare Application Launcher" in the "Description" field and press <Tab>.
5. Choose "Browse."
6. From the "Drives" drop-down list, select the drive that points to SYS:PUBLIC.
7. From the list under "File Name," select NAL.EXE and choose "OK."

The path to the executable file is placed in the "Command Line" text box.

## 8. Choose “OK” again, and then choose “Yes.”

NetWare Application Launcher is created as a program item icon in the group you selected.

You can now use the NetWare Application Launcher to access and use network applications through your Directory tree.

### Additional Information

For more information about	See
Installing Windows workstation software	<i>NetWare Client for DOS and Windows User Guide</i>  <i>IntranetWare Client for DOS and Windows 3.1x Supervisor Guide</i>  <i>IntranetWare Client for Windows 95 Supervisor Guide</i>
Using the NetWare Administrator utility	“NetWare Administrator” in <i>Utilities Reference</i>
Logging in	“LOGIN” in <i>Utilities Reference</i>

## Setting up NetWare Application Launcher on a Windows 95 Workstation

To configure NetWare Application Launcher (NAL) to run on a user’s desktop, you must perform the following procedure.

### Prerequisites



- A workstation cabled to the network and running Windows 95 and Client 32™
- A drive mapping to SYS:PUBLIC on your preferred server
- Authentication to a Novell Directory tree

### Procedure

1. From the Windows 95 desktop, right-click and choose “New.”
2. Choose “Shortcut.”
3. Choose “Browse.”
4. From the Browser, locate the drive that points to **SYS:PUBLIC\WIN95** and choose **NAL.EXE**.
5. Choose “Open.”
6. Choose “Finish.”

NetWare Application Launcher is created as a shortcut icon on your desktop.

You can now use the NetWare Application Launcher to access and use network applications through your Directory tree.

### Additional Information

For more information about	See
Installing Windows 95 workstation software	<i>IntranetWare Client for Windows 95 Supervisor Guide</i>
Using the NetWare Administrator utility	“NetWare Administrator” in <i>Utilities Reference</i>
Logging in	“LOGIN” in <i>Utilities Reference</i>

## Configuring NetWare Application Launcher

The NetWare Application Launcher can be configured for a container object, Group object, or User object. The NetWare Application Manager allows the network supervisor to specify how each user views the NetWare Application Launcher.

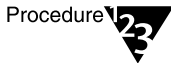
To configure NetWare Application Launcher (NAL) for a specific view, you must perform the following procedure.

### Prerequisites



- Supervisor rights to the container that contains the Application object you want to configure for
- A drive mapping to SYS:PUBLIC on your preferred server
- Access to NetWare Administrator
- Authentication to a Novell Directory tree

### Procedure



1. **From NetWare Administrator, choose the User or container object.**
2. **From the Object menu, choose “Details.”**
3. **Choose “Launcher Configuration” from the button bar.**

Follow the instructions provided within the interface to complete the procedure.

## Creating and Using NetWare Application Objects

NetWare 4.11 provides application management software that assist you in setting up and managing network applications from a single administrative console through Novell Directory Services.

The software is comprised of a NetWare Administrator tool referred to as NetWare Application Manager (NAM) and a client tool referred to as NetWare Application Launcher (NAL).

The NetWare application management tools enable management of the application life-cycle, beginning with distribution and installation to configuration and upgrades.



The NetWare Application Manager utility is only available in NetWare Administrator. The NetWare Application Launcher utility is only available in Windows 3.1x and Windows 95.

## Using NetWare Application Manager

The NetWare Application Manager (NAM) software assists you in setting up and managing network applications from the NetWare Administrator.

Using NetWare Administrator, a supervisor creates Application objects in NDS™ for any application to make it available through the NetWare Application Launcher (NAL). Rights to these application objects can then be assigned to containers, groups and users.

## Using the NetWare Application Launcher

The NetWare Application Launcher (NAL) program is a user application that leverages NDS to offer users easy access to applications stored on the network.

NAL offers easy distribution, updating, version control and license management for applications stored on the network. NAL also offers fault tolerance for the application environment.

When a user running NAL logs in through Novell Directory Services (NDS), NAL looks at the groups and containers the user belongs to and recognizes any applications that the user is authorized to access.

In the background, NetWare Application Launcher locates all the user's applications on the network and accesses them transparently when the user selects the program icon in Windows. An NAL program group displays all the appropriate application icons that the user can select to launch the application.

Available applications are scanned and updated automatically for the user.



Users don't need to worry about drive mappings, paths, or rights to the application directories. The administrator can manage the application launcher on a Container, Group, or User object level. NetWare 4 networks.

## Creating an Application Object

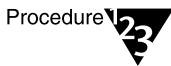
Using the NetWare Administrator utility, any Windows or DOS executable can be created as an Application object. Application objects can be managed by the network supervisor and made available to users running the NetWare Application Launcher.

### Prerequisites



- A 386 or 486 workstation running NetWare Administrator
- The Create object right to the container where the Directory Map object will be created

### Procedure



1. **Choose the “NetWare Administrator” icon from the Windows Program Manager or Desktop, or the OS/2 desktop.**
2. **From the browser, select the Organization or Organizational Unit object that will contain the Application object.**

For information about moving around in the browser and selecting objects, choose “Help” from the menu bar.

3. **Choose “Create” from the “Object” menu.**
4. **Choose the “Application Object” from the “New Object” dialog box.**

You should choose the Application object that corresponds with the type of application that you are configuring the object for.

5. **Choose “OK.”**
6. **Enter the name for the Application object in the space provided.**
7. **In the “Path” field, enter the path of the directory this Application object will point to.**

You can type in the path, or you can choose the browser button to the right of the “Path” field to browse for the directory that the Application object will point to.

8. **(Optional) To define additional properties immediately after creating the Application object, choose “Define Additional Properties.”**
9. **(Optional) To create another Application object immediately after this one, choose “Create Another Application.”**
10. **Choose “Create.”**

The Application object is created

If you chose “Create Another Application,” the Create dialog appears.

If you chose “Define Additional Properties,” the identification screen appears.

#### **Additional Information**

---

<b>For more information about</b>	<b>See</b>
Using the NetWare Administrator utility	“NetWare Administrator” in <i>Utilities Reference</i>

---

# Making the File System Secure and Accessible

## Understanding File and Directory Rights

File system security includes assigning trustee rights and setting file and directory attributes. These two types of security are discussed in the following sections.

### Trustee Rights

Trustee rights determine the access users have to directories and files. These rights can be given to User objects, Group objects, or Organizational Role objects.

Trustee rights are explained in Table 2-1.

**Table 2-1**  
**Trustee Rights**

Right	Allows you to
Access Control	Add and remove trustees and change rights to files and directories.
Create	Create subdirectories and files.
Erase	Delete directories and files.
File Scan	View file and directory names in the file system structure.
Modify	Rename directories and files, and to change file attributes.
Read	Open and read files, and to open, read, and execute applications.
Supervisor	Grant all rights listed in this table.
Write	Open, write to, and modify a file.

## Directory and File Attributes

Directory and file attributes assign properties to individual directories or files. Some attributes are meaningful only when applied at the file level, but some apply to both the directory and the file levels.

Be careful when assigning directory and file attributes. The attribute applies to *all* users.

For example, if you assign the Delete Inhibit attribute to a file, no one, including the owner of the file or the system supervisor, can delete the file. But any trustee with the Modify right can change the attribute to allow deletion.

Directory and file attributes are explained in Table 2-2.

**Table 2-2**  
**Directory and File Attributes**

Attribute	Description	Applies to
A	Archive Needed identifies files that have been modified since the last backup. This attribute is assigned automatically.	Files only
Ci	Copy Inhibit prevents Macintosh users from copying a file. This attribute overrides Read and File Scan trustee rights.	Files only
Dc	Don't Compress keeps data from being compressed. This attribute overrides settings for automatic compression of files not accessed within a specified number of days.	Directories and files
Di	Delete Inhibit means that the file or directory cannot be deleted. This attribute overrides the Erase trustee right.	Directories and files
Dm	Don't Migrate prevents files and directories from being migrated from the server's hard disk to another storage medium.	Directories and files
Ds	Don't Suballocate prevents data from being suballocated.	Files only
H	The Hidden attribute hides files and directories so they can't be listed using the DIR command. A user with File Scan rights can use FILER or the NDIR command to list directories and files with the Hidden attribute.	Directories and files
I	Index allows large files to be accessed quickly by indexing files with more than 64 File Allocation Table (FAT) entries. This attribute is set automatically.	Files only

Table 2-2 *continued*

**Directory and File Attributes**

Attribute	Description	Applies to
Ic	Immediate Compress sets data to be compressed as soon as a file is closed. If applied to a directory, every file in the directory is compressed as each file is closed.	Directories and files
N	Normal indicates the Read/Write attribute is assigned and the Shareable attribute is not. This is the default attribute assignment for all new files.	Directories and files
P	Purge flags a file or directory to be erased from the system as soon as it is deleted. Purged files and directories cannot be recovered.	Directories and files
Ri	Rename Inhibit prevents the file or directory name from being modified.	Directories and files
Ro	Read Only prevents a file from being modified. This attribute automatically sets Delete Inhibit and Rename Inhibit.	Files only
Rw	Read/Write allows you to write to a file. All files are created with this attribute.	Files only
Sh	Shareable allows more than one user to access the file at the same time. This attribute is usually used with Read Only.	Files only
Sy	The System attribute hides the file or directory so it can't be seen by using the DIR command. It can be seen if a user with File Scan rights uses FILER or the NDIR command. System is normally used with operating system files, such as DOS system files.	Directories and files
T	Transactional allows a file to be tracked and protected by the Transaction Tracking System (TTS).	Files only
X	The Execute Only attribute prevents the file from being copied, modified, or backed up. It does allow renaming. The only way to remove this attribute is to delete the file. Use the attribute for program files such as .EXE or .COM. Make a copy of a file before you flag it as Execute Only, so you can replace the file if it becomes corrupted.	Files only

## Adding a Trustee to a Directory or File

You can add a trustee to a directory or file using either the NetWare Administrator graphical utility or the FILER text utility. Both procedures are documented in this section.

### Using NetWare Administrator to Add a Trustee

Checklist



#### Prerequisites

- A 386 or 486 workstation running NetWare Administrator
- The Access Control right to the file or directory you want to add the trustee to

Procedure



#### Procedure

1. **Choose the “NetWare Administrator” icon from the MS Windows Program Manager or the OS/2 desktop.**
2. **Using the browser, select the directory or file that you want to add a trustee to.**

For information about moving around in the browser and selecting objects, choose “Help” from the menu bar.

3. **From the “Object” menu, choose “Details.”**
4. **From the “Identification” page, choose “Trustees of this Directory.”**
5. **From the “Trustees of this Directory” page, choose “Add Trustee.”**
6. **Select a trustee from the list.**

If the object does not appear in the list, browse the Directory tree to find the object that you want to make a trustee of the file or directory.

7. **Choose “OK.”**
8. **To grant rights to the trustee, mark the appropriate check boxes below the trustee.**

## 9. To return to the browser, choose “OK.”

### Additional Information

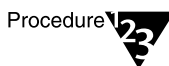
For more information about	See
Trustees	“Trustee” in <i>Concepts</i>
File system rights	“Trustee Rights” on page 133
Using the NetWare Administrator utility	“NetWare Administrator” in <i>Utilities Reference</i>

### Using FILER to Add a Trustee



#### Prerequisites

- A workstation running DOS 3.30 or later
- A minimum of 512 KB of memory available in the workstation
- Access Control right to the file or directory you want to add the trustee to



#### Procedure

##### 1. At the DOS prompt, type

**FILER** <Enter>

A list of available options appears.

Your current context, Volume object, and path are shown in the upper left corner of the screen.

##### 2. Select “Manage Files and Directories.”

The “Directory Contents” list appears.

**3. Find and select the file, directory, or subdirectory you want.**

- ◆ If the item you want appears on the list, select it and press <F10>.
- ◆ If the item is not in the list, browse a directory or subdirectory by selecting it and pressing <Enter> until you see the item you want. Select it and press <F10>.
- ◆ If you can't find the directory you want, check the Volume object name in the upper left corner of the screen. If you are in the wrong volume, you can change it by returning to the "Available Options" menu and choosing "Select Current Directory."

**4. Select "View/Set File [or Directory] Information" and press <Enter>.**

Information for that file or directory appears.

**5. Use the arrow keys to move to the "Trustees" field, and then press <Enter>.**

A list of trustees for that file or directory appears.

**6. To add a trustee, press <Insert> and locate the trustee's name in the list. Select the name and then press <Enter>.**

The new trustee, object type, and default rights appear in the list.

**7. (Optional) To add another trustee to this file or directory, press <Esc> until you get to the "File Information" screen. Then repeat Steps 5 and 6.**

**8. (Optional) Assign rights to the new trustee.**

You can assign or modify trustee rights now, or at any time after the trustee has been assigned to the directory or file.

**8a. From the trustee list, select the user you want to assign or modify rights for, and then press <Enter>.**

The "Trustee Rights" list appears, showing the rights the trustee currently has to this directory or file.

**8b. Press <Insert> to see a list of rights you can assign.**



- 8c. Select a right you want to give the trustee and press <Enter>. To give the trustee more than one right, press <F5> to mark each right, and then press <Enter>.**

The “Trustee Rights” list reappears with the new rights added.

- 8d. Press <Esc>.**

The new rights appear next to the trustee name.

- 9. Exit FILER by pressing <Esc> until you reach the Exit confirmation box, and then select “Yes.”**

### Additional Information

For more information about	See
Trustees	“Trustee” in <i>Concepts</i>
File system rights	“Trustee Rights” on page 133
Using the FILER utility	“FILER” in <i>Utilities Reference</i>

## Deleting a Trustee from a Directory or File

You can delete a trustee from a directory or file using either the NetWare Administrator graphical utility or the FILER text utility. Both procedures are documented in this section.

### Using NetWare Administrator to Delete a Trustee



#### Prerequisites

- A 386 or 486 workstation running NetWare Administrator
- The Access Control right to the file or directory you want to delete the trustee from

## Procedure



1. Choose the “NetWare Administrator” icon from the MS Windows Program Manager or the OS/2 desktop.
2. Using the browser, select a directory or file that you want to delete a trustee from.  
  
For information on moving around in the browser and selecting objects, choose “Help” from the menu bar.
3. From the “Object” menu, choose “Details.”
4. From the “Identification” page, choose “Trustees of This Directory.”
5. From the “Trustees” list, select a trustee.
6. Choose “Delete Trustee.”
7. To delete that object as a trustee, choose “Yes.”
8. To return to the browser, choose “OK.”

## Additional Information

For more information about	See
Trustees	“Trustee” in <i>Concepts</i>
Using the NetWare Administrator utility	“NetWare Administrator” in <i>Utilities Reference</i>

## Using FILER to Delete a Trustee



### Prerequisites

- A workstation running DOS 3.30 or later
- A minimum of 512 KB of memory available on the workstation
- The Access Control right to the file or directory you want to delete the trustee from

## Procedure

**1. At the DOS prompt, type**

**FILER** <Enter>

A list of available options appears.

Your current context, Volume object, and path are shown in the upper left corner of the screen.

**2. Select “Manage Files and Directories.”**

The “Directory Contents” list appears.

**3. Find and select the file, directory, or subdirectory you want.**

- ◆ If the item you want appears on the list, select it and press <F10>.
- ◆ If the item is not on the list, browse a directory or subdirectory by selecting it and pressing <Enter> until you see the item you want. Select it and press <F10>.

If you can't find what you want, check the Volume object name in the upper left corner of the screen. If you are in the wrong volume, you can change it by returning to the “Available Options” menu and choosing “Select Current Directory.”

**4. Select “View/Set File [or Directory] Information” and press <Enter>.**

Information for that file or directory appears.

**5. Use the arrow keys to move to the “Trustees” field, and then press <Enter>.**

A list of trustees for that file or directory appear.

**6. Select the trustee you want to delete, and then press <Delete>.**

You are prompted to delete that trustee from the directory.

**7. Select “Yes.”**

8. To exit, press <Esc> until the menu you want appears.

### Additional Information

For more information about	See
Trustees	"Trustee" in <i>Concepts</i>
Using the FILER utility	"FILER" in <i>Utilities Reference</i>

## Modifying a Trustee's Rights to a Directory or File

You can modify trustee rights to a directory or file through the NetWare Administrator graphical utility or the FILER text utility. Both procedures are documented in this section.

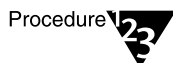
### Using NetWare Administrator to Modify a Trustee's Rights

#### Prerequisites



- A 386 or 486 workstation running NetWare Administrator
- The Access Control right to the file or directory for which you want to change the trustee's rights

#### Procedure



1. Choose the "NetWare Administrator" icon from the MS Windows Program Manager or the OS/2 desktop.
2. Using the browser, select the directory or file for which you want to change trustee rights.

For information on moving around in the browser and selecting objects, choose "Help" from the menu bar.

3. From the "Object" menu, choose "Details."
4. From the "Identification" page, choose "Trustees of this Directory."
5. From the "Trustees" list, select a trustee.

6. Grant or revoke rights by marking the check boxes below the trustee.
7. Choose “OK” to save the trustee rights.

### Additional Information

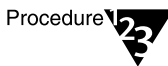
For more information about	See
File system rights	“Trustee Rights” on page 133 “Rights” in <i>Concepts</i>
Trustees	“Trustee” in <i>Concepts</i>
Using the NetWare Administrator	“NetWare Administrator” in <i>Utilities Reference</i>

## Using FILER to Modify a Trustee’s Rights



### Prerequisites

- A workstation running DOS 3.30 or later
- A minimum of 512 KB of memory available in the workstation
- The Access Control right to the file or directory for which you want to change the trustee’s rights



### Procedure

1. At the DOS prompt, type

**FILER** <Enter>

A list of available options appears.

Your current context, Volume object, and path are shown in the upper left corner of the screen.

**2. Select “Manage Files and Directories.”**

The “Directory Contents” list appears.

**3. Find and select the file, directory, or subdirectory you want.**

- ◆ If the item you want appears on the list, select it and press <F10>.
- ◆ If the item is not on the list, browse a directory or subdirectory by selecting it and pressing <Enter> until you see the item you want. Select it and press <F10>.
- ◆ If you cannot find the item you want, check the Volume object name in the upper left corner of the screen. If you are in the wrong volume, you can change it by backing out to the “Available Options” menu and choosing “Select Current Directory.”

**4. Select “View/Set File [or Directory] Information” and press <Enter>.**

**5. Using the arrow keys, move to the “Trustee” field, and then press <Enter>.**

**6. Select the name of the trustee whose rights you want to modify and press <Enter>.**

A list of the trustee’s current rights appears.

**7. Press <Insert> to see a list of rights you can assign.**

**8. Select a right you want to give the trustee, and then press <Enter>. If you want to assign more than one right, press <F5> to mark each right, and then press <Enter>.**

The “Trustee Rights” list reappears, showing the new list of rights.

**9. To exit, press <Esc>.**

The new rights appear next to the trustee name.

## Additional Information

For more information about	See
File system rights	“Trustee Rights” on page 133 “Rights” in <i>Concepts</i>
Trustees	“Trustee” in <i>Concepts</i>
Using the FILER utility	“FILER” in <i>Utilities Reference</i>

## Viewing/Modifying the Inherited Rights Filter for Directories and Files

You can view and modify the Inherited Rights Filter (IRF) for a directory or file using the NetWare Administrator graphical utility or the FILER text utility. Both procedures are documented in this section.

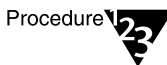
### Using NetWare Administrator to View/Modify an Inherited Rights Filter

#### Prerequisites



- A 386 or 486 workstation running NetWare Administrator
- The Access Control right to the file or directory for which you want to view or modify the IRF

#### Procedure



- 1. Choose the “NetWare Administrator” icon from the MS Windows Program Manager or the OS/2 desktop.**
- 2. Using the browser, select a directory or file.**  
For information on moving around in the browser and selecting objects, choose “Help” from the menu bar.
- 3. From the “Object” menu, choose “Details.”**
- 4. From the “Identification” page, choose “Trustees of This Directory.”**

5. Under “Inheritance Filter,” select the check boxes for the rights that you want to allow to be inherited for that directory or file.
6. Choose “OK.”  
The “Trustees” dialog reappears.
7. To return to the browser, choose “OK.”

### Additional Information

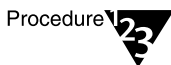
For more information about	See
Inherited rights	“Directory and File Attributes” on page 134 “Attributes,” “Inherited Rights Filter,” and “Rights” in <i>Concepts</i>
Using the NetWare Administrator utility	“NetWare Administrator” in <i>Utilities Reference</i>

## Using FILER to View/Modify the Inherited Rights Filter



### Prerequisites

- A workstation running 3.30 or later
- A minimum of 512 KB of memory available on the workstation
- The Access Control right to the file or directory for which you want to view or modify the filter



### Procedure

1. At the DOS prompt, type

**FILER** <Enter>

A list of available options appears.

Your current context, Volume object, and path are shown in the upper left corner of the screen.

2. Select “Manage Files and Directories.”



The “Directory Contents” list appears.

3. **Find and select the file, directory, or subdirectory you want.**
  - ◆ If the item you want appears on the list, select it and press <F10>.
  - ◆ If the item is not on the list, browse a directory or subdirectory by selecting it and then pressing <Enter> until you see the item you want. Select it and press <F10>.
  - ◆ If you can’t find the item you want, check the Volume object name in the upper left corner of the screen. If you are in the wrong volume, you can change it by returning to the “Available Options” menu and choosing “Select Current Directory.”

4. **Select “View/Set File [or Directory] Information” and press <Enter>.**

Information for that file or directory appears. The current inherited rights are shown in the “Inherited Rights Filter” field.

5. **Use the arrow keys to move to the “Inherited Rights Filter” field and then press <Enter>.**

A list of the rights inherited by the file or directory appears.

6. **Select a file or directory attribute you want to revoke, and then press <Delete>. To revoke more than one attribute, press <F5> to mark each attribute, and then press <Delete>.**
7. **Press <Esc>.**

The “File [or Directory] Information” screen reappears with a listing of the rights that can be inherited.

8. **To exit, press <Esc> until the menu you want appears.**

## Additional Information

For more information about	See
Inherited rights	“Directory and File Attributes” on page 134 “Attributes,” “Inherited Rights Filter,” and “Rights” in <i>Concepts</i>
Using the FILER utility	“FILER” in <i>Utilities Reference</i>

## Changing Attributes of a Directory or File

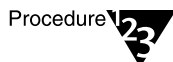
You can change the attributes of a directory or file with the NetWare Administrator graphical utility or the FILER text utility. Both procedures are documented in this section.

### Using NetWare Administrator to Change Attributes



#### Prerequisites

- A 386 or 486 workstation running NetWare Administrator
- The Modify right to the file or directory whose attributes you want to change



#### Procedure

- 1. Choose the “NetWare Administrator” icon from the MS Windows Program Manager or the OS/2 desktop.**
- 2. Using the browser, select a directory or file.**  
For information on moving around in the browser and selecting objects, choose “Help” from the menu bar.
- 3. From the “Object” menu, choose “Details.”**
- 4. From the “Identification” page, choose “Attributes.”**
- 5. Select the check boxes for the attributes that you want to set or reset for this directory or file.**

6. To close the object dialog box and save the new attributes, choose “OK.”

### Additional Information

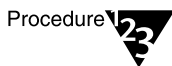
For more information about	See
File and directory attributes	“Directory and File Attributes” on page 134 “Attributes” in <i>Concepts</i>
Using the NetWare Administrator utility	“NetWare Administrator” in <i>Utilities Reference</i>

## Using FILER to Change Attributes



### Prerequisites

- A workstation running DOS 3.30 or later
- A minimum of 512 KB of memory available on the workstation
- The Modify right to the file or directory whose attributes you want to change



### Procedure

1. At the DOS prompt, type

```
FILER <Enter>
```

A list of available options appears.

Your current context, Volume object, and path are shown in the upper left corner of the screen.

2. Select “Manage Files and Directories.”

The “Directory Contents” list appears.

**3. Find and select the file, directory, or subdirectory you want.**

- ◆ If the item you want appears on the list, select it and then press <F10>.
- ◆ If the item is not on the list, browse a directory or subdirectory by selecting it and then pressing <Enter> until you see the item you want. Select it and press <F10>.
- ◆ If you can't find what you want, check the volume object name in the upper left corner of the screen. If you are in the wrong volume, you can change it by returning to the "Available Options" menu and choosing "Select Current Directory."

**4. Select "View/Set File [or Directory] Information" and press <Enter>.**

Information for the file or directory appears.

**5. To modify an attribute, use the arrow keys to move to the "Attributes" field, and then press <Enter>.**

The attributes for that file or directory appear.

**6. Modify the attribute by completing one of the following steps:**

- ◆ To delete an attribute, select it and press <Delete>. Select "Yes" when you are prompted to delete the attribute.
- ◆ To add an attribute, press <Insert>. Select the attribute you want to add and press <Enter>.

To assign more than one right, press <F5> to mark each right, and then press <Enter>.

**7. To exit, press <Esc> until the menu you want appears.**

## Additional Information

For more information about	See
File and directory attributes	“Directory and File Attributes” on page 134 “Attributes” in <i>Concepts</i>
Using the FILER utility	“FILER” in <i>Utilities Reference</i>

## Changing the Owner of a Directory or File

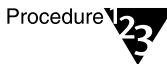
You can change the owner of a directory or file using the NetWare Administrator graphical utility or the FILER text utility. Both procedures are documented in this section.

### Using NetWare Administrator to Change the Owner



#### Prerequisites

- A 386 or 486 workstation running NetWare Administrator
- The Modify right to the file or directory for which you want to change the owner



#### Procedure

1. Choose the “NetWare Administrator” icon from the MS Windows Program Manager or the OS/2 desktop.
2. Using the browser, select the directory or file for which you want to change the owner.

For information on moving around in the browser and selecting objects, choose “Help” from the menu bar.

3. From the “Object” menu, choose “Details.”
4. From the “Identification” page, choose “Facts.”
5. To change the owner of this file or directory, click on the browser button to the right of the “Owner” field.

6. Choose the object that you want to make the new owner of this directory or file.
7. When the correct user is displayed in the “Object Name” field, choose “OK.”

The new owner appears in the “Owner” field of the object dialog box.

8. To save any changes, choose “OK.”

### Additional Information

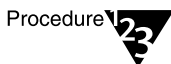
For more information about	See
Objects	Chapter 1, “Managing Novell Directory Services Objects,” on page 1  “Object” in <i>Concepts</i>
Using the NetWare Administrator utility	“NetWare Administrator” in <i>Utilities Reference</i>

## Using FILER to Change the Owner



### Prerequisites

- A workstation running DOS 3.30 or later
- A minimum of 512 KB of memory available on the workstation
- The Modify right to the file or directory for which you want to change the owner



### Procedure

1. At the DOS prompt, type

**FILER** <Enter>

A list of available options appears. Your current context, Volume object, and path are shown in the upper left corner of the screen.

2. Select “Manage Files and Directories.”

The “Directory Contents” menu appears.

**3. Find and select the file, directory, or subdirectory you want.**

- ◆ If the item you want appears on the list, select it and then press <F10>.
- ◆ If the item is not on the list, browse a directory or subdirectory by selecting it and then pressing <Enter> until you see the item you want. Select it and press <F10>.
- ◆ If you can't find what you want, check the Volume object name in the upper left corner of the screen. If you are in the wrong volume, you can change it by returning to the “Available Options” menu and choosing “Select Current Directory.”

**4. Select “View/Set File [or Directory] Information” and press <Enter>.**

Information for the file or directory appears. The current owner of the file or directory appears in the “Owner” field.

**5. Use the arrow keys to move to the “Owner” field and then press <Enter>.**

**6. Select the user that you want to be the owner of the file or directory and press <Enter>.**



(For directories only) You can apply the change of ownership to either the entire subdirectory structure or to a selected directory.

**7. To exit, press <Esc> until the menu you want appears.**

## Additional Information

For more information about	See
Objects	Chapter 1, "Managing Novell Directory Services Objects," on page 1  "Object" in <i>Concepts</i>
Using the FILER utility	"FILER" in <i>Utilities Reference</i>

# Viewing Effective Rights and Other Information

## Viewing a Trustee's Effective Rights to a Directory or File

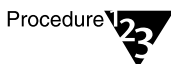
You can see the effective rights a trustee has to a directory or file by using either the NetWare Administrator graphical utility or the FILER text utility. Both procedures are documented in this section.

### Using NetWare Administrator to View a Trustee's Effective Rights



#### Prerequisites

- A 386 or 486 workstation running NetWare Administrator
- The Access Control right to the file or directory, and the Read property right to the trustee object's ACL property



#### Procedure

1. Choose the "NetWare Administrator" icon from the MS Windows Program Manager or the OS/2 desktop.

2. Using the browser, select a directory or file.

For information on moving around in the browser and selecting objects, choose "Help" from the menu bar.

3. From the "Object" menu, choose "Details."
4. From the "Identification" page, choose "Trustees of this Directory."



5. **Select the trustee whose effective rights you want to view.**

6. **Choose “Effective Rights.”**

The selected trustee’s effective rights are bolded in the “Effective Rights” box.

7. **(Optional) To view a different object’s rights to this directory or file, choose the browser button to the right of the “Trustee” text box and select an object from the browser.**

8. **To return to the browser, choose “Cancel.”**

### Additional Information

For more information about	See
Effective rights	“Effective rights” in <i>Concepts</i>
Modifying trustee rights	“Modifying a Trustee’s Rights to a Directory or File” on page 142
Using the NetWare Administrator utility	“NetWare Administrator” in <i>Utilities Reference</i>

## Using FILER to View a Trustee’s Effective Rights



### Prerequisites

- A workstation running DOS 3.30 or later
- A minimum of 512 KB of memory available on the workstation
- The Access Control right to the file or directory, and the Read property right to the trustee object’s ACL property

## Procedure

### 1. At the DOS prompt, type

**FILER** <Enter>

A list of available options appears.

Your current context, Volume object, and path are shown in the upper left corner of the screen.

### 2. Select “Manage Files and Directories.”

The “Directory Contents” menu appears.

### 3. Find and select the file, directory, or subdirectory you want.

- ◆ If the item you want appears on the list, select it and then press <F10>.
- ◆ If the item is not on the list, browse a directory or subdirectory by selecting it and then pressing <Enter> until you see the item you want. Select it and press <F10>.
- ◆ If you can't find the item on the list, check the Volume object name in the upper left corner of the screen. If you are in the wrong volume, you can change it by returning to the “Available Options” menu and choosing “Select Current Directory.”

### 4. Select “View/Set File [or Directory] Information” and press <Enter>.

Information for that file or directory appears.

### 5. Use the arrow keys to move to the “Trustees” field, and then press <Enter>.

A list of trustees for the file or directory appears, along with the object type of the trustee and the current rights the trustee has to the file or directory.

If the trustee list is empty, no effective rights exist for this file or directory. To assign trustee rights, see “Using FILER to Add a Trustee” on page 137.

## Additional Information

For more information about	See
Effective rights	"Effective rights" in <i>Concepts</i>
Modifying trustee rights	"Modifying a Trustee's Rights to a Directory or File" on page 142
Using the FILER utility	"FILER" in <i>Utilities Reference</i>

## Viewing Other Information about a Directory or File

You can see extended information about a directory or file using either the NetWare Administrator graphical utility or the FILER or NDIR text utilities. You can see file information such as

- ◆ Owner and trustees
- ◆ Attributes, effective rights, and the Inherited Rights Filter (IRF)
- ◆ Name space
- ◆ File size
- ◆ Creation, access, archive, and modify dates

You can see directory information such as

- ◆ Owner and trustees
- ◆ Creation date and time
- ◆ Attributes, effective rights, and the IRF
- ◆ Disk space limitations

Procedures for using the NetWare Administrator, FILER, and NDIR are documented in this section.

## Using NetWare Administrator to View Other Information

Checklist



### Prerequisites

- A 386 or 486 workstation running NetWare Administrator
- The Access Control right to the file or directory you want to see information about

Procedure



### Procedure

1. **Choose the “NetWare Administrator” icon from the MS Windows Program Manager or the OS/2 desktop.**
2. **Using the browser, select the file or directory you want to see information about.**

For help moving around in the browser and selecting objects, choose “Help” from the menu bar.

3. **Choose “Details” from the “Object” menu.**
4. **Select an “Information” page to view for this file or directory.**
5. **If you have made any changes on any pages, choose “OK” to save changes and return to the browser.**

If you haven’t made any changes, choose “Cancel” to return to the browser.

### Additional Information

For more information about	See
Using the NetWare Administrator utility	“NetWare Administrator” in <i>Utilities Reference</i>

## Using FILER to View Other Information

Checklist



### Prerequisites

- A workstation running DOS 3.30 or later
- A minimum of 512 KB of memory available on the workstation
- The Access Control right to the file or directory you want to see information about

Procedure



### Procedure

**1. At the DOS prompt, type**

**FILER** <Enter>

A list of available options appears.

Your current context, Volume object, and path are shown in the upper left corner of the screen.

**2. Select “Manage Files and Directories.”**

The “Directory Contents” list appears.

**3. Find and select the file, directory, or subdirectory you want.**

- ◆ If the item you want appears on the list, select it and then press <F10>.
- ◆ If the item is not on the list, browse a directory or subdirectory by selecting it and then pressing <Enter> until you see the item you want. Select it and press <F10>.
- ◆ If you can't find what you want, check the Volume object name in the upper left corner of the screen. If you are in the wrong volume, you can change it by returning to the “Available Options” menu and choosing “Select Current Directory.”

**4. Select “View/Set File [or Directory] Information.”**

Information for the file or directory appears.

**5. To exit, press <Esc> until the menu you want appears.**

## Additional Information

For more information about	See
Using the FILER utility	"FILER" in <i>Utilities Reference</i>

## Using NDIR to View Other Information

For online help with the NDIR utility's features, type one of the following commands:

- ◆ For information on the NDIR utility's sorting features, type  
`NDIR /? SORT <Enter>`
- ◆ For information on search filters (restrictions), type  
`NDIR /? RES <Enter>`
- ◆ For information on attribute filters, type  
`NDIR /? AT <Enter>`
- ◆ For information on other options, type  
`NDIR /? OPT <Enter>`
- ◆ For NDIR syntax information, type  
`NDIR /? SYN <Enter>`
- ◆ To view all of the NDIR utility's help screens, type  
`NDIR /? ALL <Enter>`



### Prerequisites

- A workstation running DOS 3.30 or later
- A minimum of 512 KB of memory available on the workstation
- The Access Control right to the file or directory you want to see information about

### Procedure

Use the NDIR commands in Table 2-3 to find information about files, directories, volumes, etc. For more information about using NDIR, see “NDIR” in *Utilities Reference*.

**Table 2-3**  
**Using NDIR to Get File and Directory Information**

To get information about	Use this NDIR command
Files only	NDIR <i>path</i> /FO
Directories only	NDIR <i>path</i> /DO
All subdirectories	NDIR <i>path</i> /S
Volumes	NDIR /VOL
Directory space	NDIR /SPA
File version	NDIR /VER
File details	NDIR <i>filename</i> /D

# Salvaging and Purging Deleted Files and Directories

Files deleted from the NetWare server remain on the disk until the deleted files are purged. Deleted files can be salvaged any time before they are purged.

Purging frees the space used to store the deleted files on the server's hard disk. If a disk runs out of free space, NetWare automatically purges first the files that were deleted first.

## Salvaging Deleted Files

Files deleted from the NetWare server can be recovered unless they have been purged.

You can salvage files by using either the NetWare Administrator graphical utility or the FILER text utility. Both procedures are documented in this section.

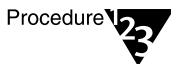
### Using NetWare Administrator to Salvage Files

#### Prerequisites



- A 386 or 486 workstation running NetWare Administrator
- The Create right to the file that has been deleted. If the file is in the "Deleted Directories" area, you need the Supervisor right to the file

#### Procedure



1. **Choose the "NetWare Administrator" icon from the MS Windows Program Manager or the OS/2 desktop.**
2. **Select the directory containing the files or directories you want to salvage.**
3. **From the "Tools" menu, choose "Salvage."**
4. **Select the source directory (current or deleted) from the "Source Options" drop box.**

If you salvage files from deleted directories on the SYS: volume, the list of files takes a long time to appear.



5. **Specify the deleted files you want listed by entering a file specification (such as wildcards) in the “Include” field.**

For example, to see a list of deleted batch files in the current directory, you would type \*.BAT in the “Include” field.

If you leave the field blank or type \*.\* you get a list of all deleted files in the selected directory.

6. **Choose “List” to display the filenames you included.**
7. **(Optional) Specify how you want the files to be listed by selecting a sort option from the “Sort Options” drop box.**

For example, you can sort by deletion date, deleter, etc. The default listing is by filename.

8. **Select the files you want to salvage.**
9. **Choose “Salvage.”**

If you salvage files from an existing directory, the files are restored to that directory. If you salvage files from a deleted directory, the files are restored under the root directory.

10. **To return to the browser, choose “Close.”**

### Additional Information

For more information about	See
Salvaging files	“Salvageable files” in <i>Concepts</i>
Using the NetWare Administrator utility	“NetWare Administrator” in <i>Utilities Reference</i>

## Using FILER to Salvage Files

Checklist



### Prerequisites

- A workstation running DOS 3.30 or later
- A minimum of 512 KB of memory available on the workstation
- The Create right to the file that has been deleted. If the File is in the “Deleted Directories” area, you need the Supervisor right to the file

Procedure



### Procedure

**1. At the DOS prompt, type**

**FILER** <Enter>

A list of available options appears.

Your current context, Volume object, and path are shown in the upper left corner of the screen.

**2. Select “Salvage Deleted Files.”**

The “Salvage” menu appears.

**3. Salvage files from an existing directory or a deleted directory by completing one of the following steps:**

- ◆ To salvage files from an existing directory, select “View/Recover Deleted Files” from the “Salvage” menu.
- ◆ To salvage files from a deleted directory, select “Salvage Deleted Directories” from the “Salvage” menu; then select the volume that contained the deleted directory and press <Enter>.

4. **When prompted, type a filename or wildcard to indicate the files you want to salvage, and then press <Enter>.**

For example, if you want to recover all files with the .EXE extension, type \*.EXE. Or, if you want to recover all files that have RPT in their names, type \*RPT\*.

If you do not specify a filename or wildcard, all files that have been deleted from the directory will be listed.

A list of deleted files appears. If you salvage files from deleted directories on the SYS: volume, the list of files takes a long time to appear.

5. **(Optional) Specify how you want the filenames to be listed by using the sort option.**

- 5a. **Press <F3>.**

- 5b. **From the “Salvage Sort Options” menu, select the way you want the files to be listed.**

You can sort the files by deletion date, deletion, etc. The default listing is by filename.

6. **Select the files to salvage from the list, and press <Enter>. To salvage more than one file, press <F5> to mark each file, and then press <Enter>.**

If you salvage files from an existing directory, the files are restored to that directory.

If you salvage files from a deleted directory, the files are restored under the root directory.

7. **To exit, press <Esc> until the menu you want appears.**

### Additional Information

For more information about	See
Salvaging files	“Salvageable files” in <i>Concepts</i>
Using the FILER utility	“FILER” in <i>Utilities Reference</i>

## Purging Files

Purging files frees disk space on the NetWare server's hard disk.



Purged files *cannot* be salvaged.

You can purge files using either the NetWare Administrator graphical utility or the FILER text utility. Both procedures are documented in this section.

### Using NetWare Administrator to Purge Files

#### Prerequisites



- A 386 or 486 workstation running NetWare Administrator
- The Erase right to the deleted file or directory you want to purge. If the file is in the "Deleted Directories" area, you need the Supervisor right to the file

#### Procedure



1. **Choose the "NetWare Administrator" icon from the MS Windows Program Manager or the OS/2 desktop.**
2. **Select the directory containing the files or directories to be purged.**
3. **From the "Tools" menu, choose "Salvage."**
4. **Select the source directory (current or deleted) from the "Source" drop box.**
5. **Enter a file specification (such as wildcards) in the "Include" field to specify files to be listed.**

For example, to see a list of deleted batch files in the current directory, you would type `.bat` in the Include field.

If you leave the field blank or type `*.*` you get a list of all deleted files in the current directory.

6. **Choose List to display the filenames you specified.**

7. **(Optional) Specify how you want the filenames to be listed by selecting a sort option from the “Sort Options” drop box.**

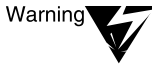
For example, you can sort by deletion date, deleter, etc. The default listing is by filename.

8. **Select the files to be purged.**

If no files are selected, then *all* deleted files are purged.

9. **Choose “Purge.”**

10. **To return to the browser, choose “OK.”**



### Additional Information

For more information about	See
Purging files	“Purge (P) attribute” in <i>Concepts</i>
Using the NetWare Administrator utility	“NetWare Administrator” in <i>Utilities Reference</i>

## Using FILER to Purge Files

### Prerequisites



- A workstation running DOS 3.30 or later
- A minimum of 512 KB of memory available on the workstation
- The Erase right to the deleted file or directory you want to purge. If the file is in the “Deleted Directories” area, you need the Supervisor right to the file

## Procedure



### 1. At the DOS prompt, type

**FILER** <Enter>

A list of available options appears.

Purge does *not* allow you to browse directories. Your current context, Volume object, and path are shown in the upper left corner of the screen. Make sure you are in the correct location in the Directory tree.

### 2. Select “Purge Deleted Files.”

You are prompted for a filename pattern.

### 3. Type a filename or a wildcard to specify the deleted files that you want to purge, and then press <Enter>.



If you do not specify a filename pattern, *all* deleted files are purged. As soon as you press <Enter> for Step 4, purging starts.

### 4. From the “Purge Options” menu, specify whether to purge files in the current directory only, or in the entire subdirectory structure of the current directory.

A list of the directories being checked and the files being purged appears.

### 5. To exit, press <Esc> until the menu you want appears.

## Additional Information

For more information about	See
Purging files	“Purge (P) attribute” in <i>Concepts</i>
Using the FILER utility	“FILER” in <i>Utilities Reference</i>

## About Login Scripts

You can use login scripts to automatically set up your users' workstation environments whenever they log in to the network. Login scripts are similar to configurable batch files and are executed by the LOGIN utility. You can use login scripts to

- ◆ Map drives and search drives to directories
- ◆ Display messages
- ◆ Set environment variables
- ◆ Execute programs or menus

Login scripts work the same way for DOS, Microsoft\* Windows (MS Windows), and OS/2\* workstations.

Some login script commands that apply to DOS and MS Windows workstations may not apply to OS/2 workstations. These differences are indicated in the description of each command later in this chapter.

## Four Types of Login Scripts

When a user logs in, the LOGIN utility executes the appropriate login scripts. Four types of login scripts are available, and they can be used separately or together to tailor a custom environment for your users. All four types of login scripts are optional.

- ◆ A container login script sets the general environments for all users in that container. The LOGIN utility executes container login scripts first. A user can use only one container login script.



A container login script replaces the system login script from NetWare 3™.

- ◆ A profile login script sets environments for several users at the same time. The LOGIN utility executes a profile login script after the container login script.

A user can be assigned only one profile login script, but can specify other profile login scripts on the command line. Several users can use the same profile login script.

- ◆ A user login script sets environments specific to a single user, such as printing options or a username for electronic mail. The LOGIN utility executes the user login script after any container and profile login scripts have executed.

A user can have only one user login script.

- ◆ The default login script is precoded into the LOGIN.EXE command and is not editable. It executes if a user doesn't have his or her own user login script, even if a container or profile login script exists.

The default login script is executed for all users (including user ADMIN) unless you create a user login script. The default login script contains only essential commands such as drive mappings to the NetWare® utilities.

(To see the commands in the default login script, see "Default Login Script" on page 240.)

If you don't want to create any user login scripts and you don't want the default login script to execute for any users, you can disable the default login script by including the NO\_DEFAULT command in the container or profile login script.

To use the login script from an Organization, Organizational Unit, or Profile object, users must have the Browse right to the object and the Read right to the object's Login Script property.



For more information on Browse or Read rights for a file, object, or property, see "Browsing" and "Rights" in *Concepts*.



## Deciding Which Login Scripts to Create

Maintaining many user login scripts can be time consuming. Therefore, you should try to include as much customizing information as possible in the container and profile login scripts, which are fewer in number and easier to maintain.

For example, if all users need access to the NetWare utilities in the same volume, put the search drive mapping to that volume in a single container login script rather than in every user login script.

Create profile login scripts if there are several users with identical login script needs.

Finally, in user login scripts, include only those individual items that can't be included in profile or container login scripts.

Since up to three login scripts can execute whenever a user logs in, conflicts can occur. If this happens, the last login script to execute (usually the user login script) overrides any conflicting commands in a previous login script.

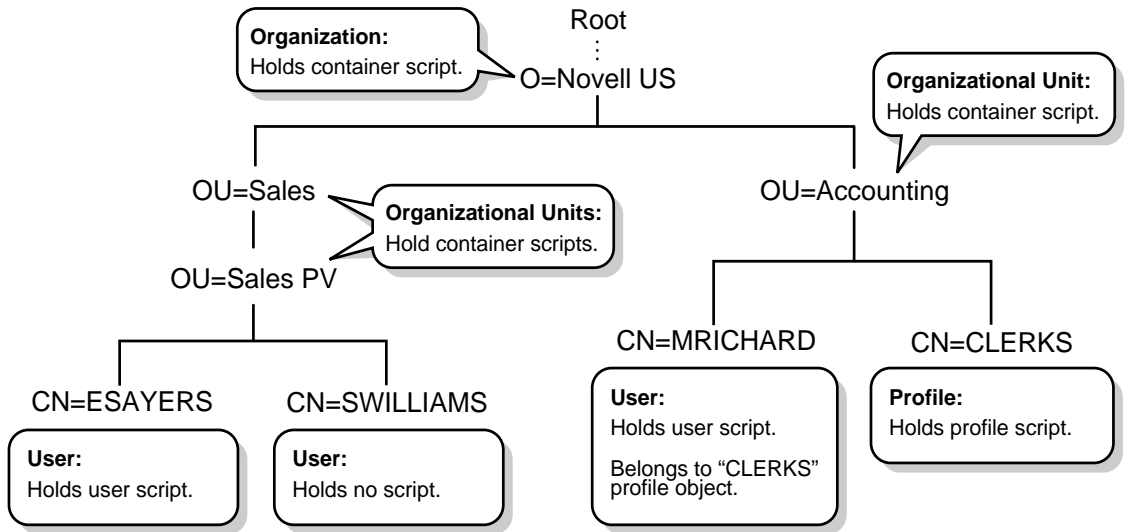
Login scripts are properties of objects. Table 3-1 shows which objects can contain which login scripts.

**Table 3-1**  
**Objects That Contain Login Scripts**

Object	Type of Login Script
Organization	Container
Organizational Unit	Container
Profile	Profile
User	User

Figure 3-1 shows where the different types of login scripts can reside in a Directory tree.

**Figure 3-1**  
**Where Login Scripts Are Located**



In the previous figure, there are three users, ESAYERS, SWILLIAMS, and MRICHARD. The following table shows which login scripts execute when each of these users logs in.

When this user logs in	Login scripts execute in this order
ESAYERS	<ol style="list-style-type: none"> <li>1. Sales PV's container login script</li> <li>2. ESAYERS' user login script</li> </ol>
SWILLIAMS	<ol style="list-style-type: none"> <li>1. Sales PV's container login script</li> <li>2. Default login script</li> </ol>
MRICHARD	<ol style="list-style-type: none"> <li>1. Accounting's container login script</li> <li>2. CLERKS' profile login script</li> <li>3. MRICHARD's user login script</li> </ol>

Container login scripts only affect users in the Organization or Organizational Unit that contains the login script.

For example, in Figure 3-1, although there are two levels of container objects above users ESAYERS and SWILLIAMS, only the container login script they're in (OU=SALES\_PV) executes when they log in.

If the SALES\_PV Organizational Unit had no container login script defined, no container login script would execute for ESAYERS and SWILLIAMS, even though a container login script exists at a higher level.

Because user SWILLIAMS has no user login script defined, the default login script executes after the container login script.

Since user MRICHARD belongs to the profile CLERKS, the CLERKS profile login script executes before MRICHARD's user login script. Users can be assigned to only one Profile object, but other profile login scripts can be specified at the command line. For example,

```
LOGIN username /p profile_object
```

You can, however, assign users to more than one Group object. Then use the MEMBER OF “*group*” identifier variable to specify that different parts of a login script execute, depending on the Group objects that the user belongs to.

For more information about using the MEMBER OF “*group*” identifier variable in login scripts, see “IF...THEN” on page 203 and “Identifier Variables” on page 234.

## Using Login Scripts from Other NetWare Versions

When you use INSTALL.NLM to upgrade a previous version of NetWare to NetWare 4™, the login scripts in the former login directory are automatically added to the Directory database as properties of their respective objects.<sup>216</sup>

In most cases, these earlier login scripts are compatible with NetWare 4 running Novell® Directory Services™. However, we recommend you review all your login scripts to see if they should be updated to take advantage of NetWare 4 functionality.

If you use a previous version of the NetWare MENU utility to execute a menu program from within a login script, see “Converting Old Menu Files” on page 825 for instructions on updating the menu program.

After you convert the menu, change the command in the login script from “#MENU *menu\_name*” to “#NMENU *menu\_name*.”

In previous versions of NetWare, login scripts for OS/2 and DOS were separate. In NetWare 4, only one login script is used for both OS/2 and DOS environments.

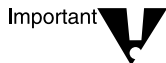
If a NetWare 3.11 user, for example, has both an OS/2 and a DOS login script, both of those login scripts are combined into a single login script when that user is upgraded to NetWare 4.

The commands from the OS/2 login script appear first in the upgraded login script, followed by the commands from the DOS script.

When the user logs in, the LOGIN utility determines whether the user is using OS/2 or DOS. Because of IF statements put in the script during migration/upgrade, LOGIN executes only the section of the upgraded script that contains the corresponding commands.

## Creating, Modifying, Copying, and Printing Login Scripts

To create or modify login scripts and to copy one object's login script into another's, you can use either the NetWare Administrator graphical utility or the NETADMIN text utility. Both procedures are documented in this section.



If you are logged in to a server running NetWare 2 or NetWare 3 and that server is in a Directory tree, you must not create or edit a login script using the SYSCON utility. If you do, the changes to that login script will not appear in your Novell Directory Services login script.

The reason is that your Novell Directory Services login script is a property of your User object, while your bindery-based login script is a file in your MAIL directory.

The main difference in creating container, profile, and user login scripts is the object you select to contain the login scripts.

- ◆ Container login scripts are assigned to container objects (Organization or Organizational Unit objects).
- ◆ Profile login scripts are assigned to Profile objects. For a User object to use a profile login script, you must select that User object and assign it to the Profile.
- ◆ User login scripts are assigned to User objects.

All four types of login scripts use the same conventions, commands, and variables.

## Login Script Hints

The following hints can help you plan effective login scripts. For a description of the commands you can use in a login script, see “Login Script Commands and Variables” on page 187. For login script examples, see “Examples of Login Scripts” on page 240.

Table 3-2  
**Login Script Conventions**

Subject	Convention
Minimum login script	No minimum. All four types of login scripts are optional. Login scripts can have only one line or they can have many. There are no required commands for login scripts.
Case	Either uppercase or lowercase is accepted. Exception: identifier variables enclosed in quotation marks and preceded by a percent sign (%) must be uppercase. See “Identifier Variables” on page 234.
Characters per line	150 characters per line is maximum; 78 characters per line (common screen width) is recommended for readability.
Punctuation and symbols	Type all symbols (#, %, “, _ ) and punctuation exactly as shown in examples and syntax.

Table 3-2 *continued*

### Login Script Conventions

Subject	Convention
Commands per line	<p>Use only one command per line. Start each command on a new line; press &lt;Enter&gt; to end each command and start a new command.</p> <p>Lines that wrap automatically are considered one command.</p> <p>WRITE command output displays better if WRITE is repeated at the beginning of each wrapped line.</p>
Sequence of commands	<p>Generally, enter commands in the order you want them to execute, with the following restrictions:</p> <ul style="list-style-type: none"><li>◆ ATTACH commands must precede related MAP commands to avoid prompting the user for a username/password during login.</li><li>◆ If you use “#” to execute an external program, it must follow any necessary MAP commands.</li><li>◆ If sequence is not important, group similar commands, such as MAP and WRITE commands, together to make the login script easier to read.</li></ul>
Blank lines	<p>Blank lines don’t affect login script execution. Use them to visually separate groups of commands.</p>
Remarks (REMARK, REM, asterisks, and semicolons)	<p>Lines beginning with REMARK, REM, an asterisk, or a semicolon are comments, which don’t display when the login script executes. Use remarks to record the purpose of each command or group of commands. (For examples, see “REMARK” on page 223.)</p>
Identifier variables	<p>Type identifier variables exactly as shown. For the value of an identifier variable to be displayed on the workstation’s screen as part of a WRITE command, you must enclose the identifier in quotation marks and precede it by a percent sign (%). See “Identifier Variables” on page 234.</p>

# Creating or Modifying a Login Script Using NetWare Administrator

Use the following instructions to create any of the three user-created types of login scripts (container, profile, or user).

Checklist



## Prerequisites

- A workstation running NetWare Administrator.
- The Write property right to the object that will contain the login script.
- The object to which you are going to assign the login script must already exist (Organization, Organizational Unit, Profile, or User object).

Procedure



## Procedure

1. **Choose the “NetWare Administrator” icon from the MS Windows Program Manager or the OS/2 desktop.**
2. **Using the browser, select the object whose login script you are creating or modifying.**

For information about moving around in the browser and selecting objects, choose Help from the menu bar.

3. **Choose “Details” from the “Object” menu.**
4. **Choose the “Login Script” page.**
5. **Enter the login script commands and information into the login script text box.**

For a description of all login script commands, see “Login Script Commands and Variables” on page 187. For login script examples, see “Examples of Login Scripts” on page 240.

- 6. Choose “OK” to save the login script and close the “Details” dialog box.**

If the login script you just created was a container or user login script, you’re finished.

If the login script you just created was for a Profile object, continue with Step 7.

- 7. (Profile login scripts only) Using the browser, select the User object that needs to use the profile login script.**
- 8. Choose “Details” from the “Object” menu.**
- 9. Choose the “Login Script” page.**
- 10. Enter the name of the Profile object in the “Default Profile” field located under the login script text box.**

You can type in the complete name of the Profile object, or you can choose the browser button next to the “Default Profile” field to select the Profile object.

- 11. To save the Profile object name and close the “Details” dialog box, choose “OK.”**

Now you must add the User object as a trustee of the Profile object.

- 12. Using the browser, select the Profile object.**
- 13. Choose “Trustees of This Object” from the “Object” menu.**
- 14. Choose “Add Trustee.”**
- 15. Enter the name of the User object who is using this Profile object.**

You can type in the complete name of the User object, or you can choose the browser button to select the Profile object.



- 16. Make sure the Browse object right and the Read property right are checked, and then choose “OK” to assign these rights to the User object.**

The User object is now a trustee of the Profile object and has the rights necessary to run the profile login script

### Additional Information

---

**For more information about See**

---

Creating a Profile object	“Managing Profile Objects” on page 51
Examples of login scripts	“Examples of Login Scripts” on page 240
Login script commands and variables	“Login Script Commands and Variables” on page 187
Using the NetWare Administrator utility	“NetWare Administrator” in <i>Utilities Reference</i>

---

## Creating or Modifying a Login Script Using NETADMIN

Use the following instructions to create any of the three user-created types of login script (container, profile, or user).

### Prerequisites



- A workstation running DOS 3.30 or later and the NETADMIN utility
- The Write property right to the object that will contain the login script.
- The object to which you are going to assign the login script must already exist (Organization, Organizational Unit, Profile, or User object).



## Procedure

**1. At the DOS Prompt, type**

`NETADMIN <Enter>`

**2. Choose “Manage Objects” from the “NetAdmin Options” menu.**

**3. Select the object whose login script you want to create.**

- ◆ If the object you want appears in the list, select it and press <F10>.
- ◆ If the object is not in the list, browse the directory by selecting container objects and pressing <Enter> until you see the object you want. Select it and press <F10>.

**4. Select “View or Edit Properties of This Object.”**

**5. Select “Login Script.”**

If you are editing an existing login script that already contains some commands, continue with Step 6.

If this login script is empty, a message appears asking if you want to copy a login script from another object.

- 5a. If you do not want to copy the login script from another object, answer No and continue with Step 6.**
- 5b. To copy a login script from another object, answer Yes and select the name of the object whose script you want to copy. Then continue with Step 6.**

The login script is copied into the login script text box.

**6. Enter the login script commands and information in the login script text box.**

For a description of all login script commands, see “Login Script Commands and Variables” on page 187. For login script examples, see “Examples of Login Scripts” on page 240.

**7. To save the login script, press <F10>.**

If the login script you just created was a container or a user login script, you're finished.

If the login script you just created was for a Profile object, continue with Step 8.

**8. (Profile login scripts only) Press <Esc> repeatedly until you return to the browser.**

**9. Select the User object that needs to use the profile login script.**

You can either type the object's complete name and press <F10>, or you can press <Insert> to browse through the Directory tree and choose the name.

**10. Select "View or Edit Properties of This Object."**

**11. Select "Memberships."**

**12. Select the "Profile" field and press <Insert>.**

**13. Enter the name of the Profile object in the box that appears.**

You can either type the object's complete name and press <F10>, or you can press <Insert> to browse through the Directory tree and select the name.

**14. Press <F10> to save the changes.**

Now you must add the User object as a trustee of the Profile object.

**15. Return to the "Manage Objects" menu.**

**16. Through the browser, select the Profile object.**

Press <Insert> to browse through the Directory tree and choose the name.

**17. Select "View or Edit the Trustees of This Object."**

**18. Select "Trustees."**

19. **To add the User object as a trustee of this Profile object, press <Insert>.**
20. **Enter the name of the User object who needs to be a trustee of this Profile object.**

You can either type the object's complete name and press <F10>, or you can press <Insert> to browse through the Directory tree and choose the name.

21. **Select “[All Properties Rights].”**
22. **To add the user as a trustee and grant the default property right, press <Enter>.**

The User object is added as a trustee of the Profile object and is given the Read right to all of the Profile's properties.

Now you must assign the Browse object right to the User object.

23. **Enter the name of the User object.**

You can either type the object's complete name and press <F10>, or you can press <Insert> to browse through the Directory tree and choose the name.

24. **Choose “[Object Right].”**

25. **To grant the default object right, press <Enter>.**

The User object is given the Browse object right. The User object now has all rights necessary to use the Profile object's login script.

26. **To exit NETADMIN, press <Esc> until you get to the confirmation prompt, and then select “Yes.”**

### **Additional Information**

---

<b>For more information about</b>	<b>See</b>
Creating a Profile object	“Managing Profile Objects” on page 51
Examples of login scripts	“Examples of Login Scripts” on page 240

---

For more information about	See
Login script commands and variables	“Login Script Commands and Variables” on page 187
Using the NETADMIN utility	“NETADMIN” in <i>Utilities Reference</i>

## Copying a Login Script Using NetWare Administrator

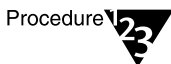
Use the following instructions to copy all or part of a login script and paste it into another object’s login script.

### Prerequisites



- A workstation running NetWare Administrator.
- The Write property right to the object that will contain the login script.
- The objects whose login scripts you will be working with must already exist (Organization, Organizational Unit, Profile, or User object).

### Procedure



1. **Choose the “NetWare Administrator” icon from the MS Windows Program Manager or the OS/2 desktop.**
2. **Using the browser, select the object whose login script you want to copy.**

For information about moving around in the browser and selecting objects, choose Help from the menu bar.

3. **Choose “Details” from the “Object” menu.**
4. **Choose the “Login Script” page.**
5. **In the login script text box, highlight the text you want to copy.**
6. **Press <Ctrl>+<Insert> to copy the highlighted text.**

The highlighted text has been placed in clipboard memory and can be pasted into another login script.

7. **To save the login script and close the “Details” dialog box, choose “OK.”**
8. **Using the browser, select the object whose login script you want to paste the copied text into.**
9. **Choose “Details” from the “Object” menu.**
10. **Choose the “Login Script” page.**
11. **In the login script text box, place the cursor where you want the copied text to appear.**
12. **Press <Shift>+<Insert> to paste the copied text into the login script.**
13. **To save the login script and close the “Details” dialog box, choose “OK.”**

## Copying a Login Script Using NETADMIN

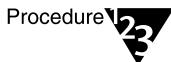
Use the following instructions to copy all or part of a login script and paste it into another object’s login script.

### Prerequisites



- A workstation running DOS 3.30 or later and the NETADMIN utility
- The Write property right to the object that will contain the login script.
- The objects whose login scripts you will be working with must already exist (Organization, Organizational Unit, Profile, or User object).

### Procedure



1. **At the DOS prompt, type**  
**NETADMIN <Enter>**

2. **Choose “Manage Objects” from the “NetAdmin Options” menu.**
3. **Select the object whose login script you want to copy.**
  - ◆ If the object you want appears in the list, select it and press <F10>.
  - ◆ If the object is not in the list, browse the Directory by selecting container objects and pressing <Enter> until you see the object you want. Select it and press <F10>.
4. **Select “View or Edit Properties of This Object.”**
5. **Select “Login Script.”**
6. **In the login script text box, place the cursor at the beginning of the text you want to copy and press <F5> to mark the beginning of the text.**
7. **Use the arrow keys to move to the end of the text you want to copy.**

As you move the cursor, text in the login script is highlighted. This highlighted text will be copied by first deleting it here, then reinserting it here, and then inserting it into the new login script.
8. **To delete the text from the login script, press <Delete>.**

Although you have deleted the text, the text has been placed in a clipboard memory and can be retrieved.
9. **To insert the text from the login script, press <Insert>.**

The deleted text has now been restored to your login script. A copy of the text still resides in the clipboard memory, so you can paste it into another object’s memory.
10. **To exit the login script, press <Esc>, and select “No” when asked if you want to save the changes you made.**
11. **Return to the browser screen.**
12. **Select the object whose login script you want to paste the copied text into.**

You can either type the object's complete name and press <F10>, or you can press <Insert> to browse through the Directory tree and choose the name.

13. Select "View or Edit Properties of This Object."
14. Select "Login Script."
15. In the login script text box, place the cursor where you want the copied text to appear.
16. To paste the copied text into the login script, press <Insert>.
17. To save the changes, press <F10>.

## Printing Login Scripts

Use the following instructions to print a login script.

### Prerequisites



- A workstation running DOS 3.30 or later
- The Read and File Scan property rights to the object to be printed.

### Procedure

To print a login script from the command line, use the NLIST command and redirect the output to a file or a printer. You must be in an object's parent container to see and print the login script of that object.

To print a user's login script, type:

```
NLIST user <username> show "login script" >LPT1
```

To print a container's login script, type:

```
NLIST "organizational unit" = "ou name" show  
"login script" >LPT1
```

Any parameter of the NLIST command that includes a space in its name must be enclosed in quotes.



# Login Script Commands and Variables

This section describes the commands you can use in a login script. The commands are presented in alphabetical order.

Syntax conventions for login script commands, as shown in Table 3-3, are the same as those for workstation text utilities, with one exception: Some login script commands must be preceded by the # symbol.

Following is an example of the syntax for the MAP login script command:

```
MAP [option] drive:=drive:|path <Enter>
```

The command syntax is described in the table.

**Table 3-3**  
**Command Syntax Conventions**

Convention	Explanation
MAP	Words in uppercase letters are keywords that must be included in the command and spelled exactly as shown. However, it doesn't matter if you type them in uppercase or lowercase letters.
[ ]	Square brackets indicate that the enclosed item is optional.
	A vertical bar means you can use either the item to the left of the bar or the item to the right, but not both. In the previous MAP example, you can enter either the drive letter or a complete path.
<i>drive</i>	Words in italics are variables. Replace variables with information specific to your task.
[ <i>option</i> ]	Options or parameters for each command are listed with the command. Options and parameters can often be abbreviated.
<Enter>	Angle brackets indicate a key you should press.
[[ ]]	Nested square brackets indicate that all enclosed items are optional. However, if you use the items within the innermost brackets, you must also use the items within the outer brackets.

## # (Execute External Program)

Use this command (the # symbol) to execute a program that is external to the login script.

### Command Format

```
# [path] filename [parameter]
```

Replace *path* with a drive letter, or, if you have specified NOSWAP on the command line or in the login script, you may replace *path* with a full directory path beginning with the NetWare volume name.

Replace *filename* with an executable file (files that end in .EXE, .COM, or .BAT, for example). Do not include the extension.

Replace *parameter* with any parameters that must accompany the executable file.

### Using #

If you want the LOGIN utility to execute a program that is external to the login script, enter the # command (symbol) followed by the name of the file you want to execute.

This command fails when

- ◆ The given directory is invalid
- ◆ Proper security rights are lacking
- ◆ The executable file cannot be found
- ◆ Insufficient workstation memory is available to load the file



LOGIN swaps to extended or expanded memory or to disk unless NOSWAP is specified on the command line or in the login script.

NOSWAP prevents LOGIN from being swapped out of conventional memory. Then, if the station does not have enough memory to handle both LOGIN and the # command, the # command fails but the rest of the login script executes normally.

For more information, see "SWAP" on page 230.

## Examples

When you want to define a default print queue and printer, you can make the login script execute the NetWare CAPTURE utility. This allows you to send print jobs to a network print queue (named QUEUE\_FOR\_LASERJET in this example).

If you have a search drive mapped to SYS:PUBLIC where the NetWare utilities are stored, you could enter the following command in the login script:

```
#CAPTURE Q=QUEUE_FOR_LASERJET NB TI=10 NFF
```

You do not need to enter a path in this case because CAPTURE is located in a search drive.

If you do not have a search drive mapped to a directory, include the path to that directory in the command. For example, to run a batch file named BATCH.BAT in the ACCOUNTS directory, use the following command:

```
#Z : \ACCOUNTS\BATCH
```

### Additional Information

For more information about	See
Using the NOSWAP command	"NOSWAP" on page 220
Using the SWAP command	"SWAP" on page 230

## ATTACH

Use ATTACH to connect to a bindery-based NetWare server (NetWare 2 or NetWare 3), or to a NetWare 4 server using bindery services, while the login script is running.

### Command Format

```
ATTACH [server[/username[;password]]]
```

## Using ATTACH

Replace *server* with the name of the NetWare server to which you want to attach.

Replace *username* with the login name. If you do not include the username, the user is prompted for a login name when the ATTACH command is executed from the login script.

You can replace *password* with the correct password for that user and server. If the username and password are the same as the primary login username and password, you can omit the password and not be prompted for it.

Use caution when including passwords in a login script, however. It is more secure to eliminate the password. Then, at the point in the login script where the ATTACH command is executed, the user is prompted for the password.

### Example

To attach user MRICHARD (whose password is “GOLFING”) to a server named REPORTS (which is a bindery-based server running NetWare 3), add the following line to her login script:

```
ATTACH REPORTS/MRICHARD;GOLFING
```

## BREAK

Use BREAK ON to allow the user to terminate execution of the login script. The default is BREAK OFF.

### Command Format

```
BREAK ON|OFF
```

## Using BREAK

If BREAK ON is included in a login script, you can press <Ctrl>+<C> or <Ctrl>+<Break> to abort the normal execution of your login script.

Including BREAK ON in a login script does not affect the DOS <Ctrl>+<Break> check. For more details, see “DOS BREAK” on page 195.

When the BREAK option is ON, type-ahead keyboard input is not saved in the buffer.

## CLS

Use CLS to clear the display from the workstation’s screen during the login process.

### Command Format

CLS

### Using CLS

When a user logs in, a login script may display messages on the user’s workstation screen.

If the CLS command is added to the login script, any messages generated by commands earlier in the login script are cleared from the screen.

## COMSPEC

To execute DOS commands from the network, use COMSPEC in the login script. Specify the directory where DOS and the DOS command processor (COMMAND.COM) are loaded.

COMSPEC is originally set when DOS is booted. It must be reset after you log in to change the location that COMMAND.COM loads from while you’re in the network.



Users running virtual DOS sessions under OS/2 should not use this command in the login script. For more information, see “Using COMSPEC with OS/2” on page 192.

## Command Format

```
COMSPEC=[path]COMMAND.COM
```

Replace *path* with either a drive letter or a full directory path beginning with the NetWare volume name.

## Using COMSPEC

- ◆ If users are running DOS from a network directory, first map a search drive in the login script to that directory and then add the COMSPEC command to the login script.
- ◆ (You may want to map a fake root to the DOS directory. For information about mapping a fake root, see “MAP” on page 210.)
- ◆ If all users use the same version of DOS from the network, you can add the COMSPEC command to the container login script.
- ◆ If more than one version of DOS is available on your network, a network directory should exist for each DOS version. In this case, you can put COMSPEC commands in either profile or user login scripts, to make sure each workstation accesses the version of DOS it needs.
- ◆ If users are running DOS from their local drives, do not add COMSPEC to login scripts.
- ◆ To use an environment variable as the value in a COMSPEC command, precede it with the percent sign (%), as follows:

```
COMSPEC=%environment variable
```

## Using COMSPEC with OS/2

For information about accessing the correct version of DOS from OS/2, see *NetWare Client for OS/2 User Guide*.

## CONTEXT

Use CONTEXT to set a user's current context in the Directory tree.

## Command Format

```
CONTEXT context
```

## Using CONTEXT

To change the current Directory tree context, replace *context* with the context you want the user to see after login.

Similarly to the workstation CX utility, you can enter a complete name to move down through the context, or you can use periods to move up toward the root of the tree.



Note

CONTEXT does not support all options that the CX workstation utility does. It only sets the context.

## Example

To change the context to the Organizational Unit SALES, under the Organization NOVELL\_US, add the following line to the login script:

```
CONTEXT .SALES.NOVELL_US
```

You can type a single period instead of a container name to indicate that you want to move up one level.

For example, if you are in the context SALES.NOVELL\_US and you want to move up one level to the context NOVELL\_US, add the following line to the login script.

```
CONTEXT .
```

To move up two levels, enter two periods, and so on.

## Additional Information

For more information about	See
Context	"Context" in <i>Concepts</i>
Using the CX utility	"CX" in <i>Utilities Reference</i>

## DISPLAY

Use `DISPLAY` to show the contents of a text file on a workstation's screen when the user logs in.

This command works best with an ASCII file. If you use `DISPLAY` with a word-processing file, printer and word-processing codes are displayed with the text.

### Command Format

```
DISPLAY [path] filename
```

Replace *path* with either a drive letter or a full directory path beginning with the NetWare volume name.

Replace *filename* with the complete name (including the extension) of the file you want to display.

### Using DISPLAY

When you use `DISPLAY` to display the contents of a file on the screen, the exact characters in the file, including any printer and word-processing codes, appear on the workstation screen. (To display only the text and suppress codes, use `FDISPLAY`. See "Using `FDISPLAY`" on page 200)

If the given directory does not exist or if the file is not found, no error message appears on the screen when the user logs in.

### Example

Suppose you put messages in a file called `SYSNEWS.TXT`, in the directory `SYS:PUBLIC\MESSAGES`, and you want your users to see this file on their screens when they log in on Mondays. Add the following lines to the container login script:

```
IF DAY_OF_WEEK="Monday" THEN
    DISPLAY SYS:PUBLIC\MESSAGES\SYSNEWS.TXT
END
```



## DOS BREAK

Use `DOS BREAK` to set the <Ctrl>+<Break> checking level for DOS.

If `DOS BREAK` is set to `ON`, you can terminate a program (other than the login script) by pressing <Ctrl>+<Break>. This command does not apply to OS/2 workstations.



This command is different from the `BREAK` command that terminates a login script. For more details, see “`BREAK`” on page 190.

### Command Format

```
DOS BREAK [ON|OFF]
```

### Using DOS BREAK

Enter the following command in the login script:

```
DOS BREAK ON
```

The default is `DOS BREAK OFF`.

## Additional Information

For more information about	See
Using the DOS BREAK command	Your DOS manual
Using the BREAK login script command	"BREAK" on page 190

## DOS SET

See "SET" on page 224.

## DOS VERIFY

Use DOS VERIFY to verify that data written to a local drive is not written to a bad sector and can be read without an error.

### Command Format

```
DOS VERIFY [ON|OFF]
```

### Using DOS VERIFY

The DOS COPY and NCOPY commands do not automatically verify that data copied to a local drive can be read after the copy.

To assure verification of each copy operation after login, add the VERIFY ON and DOS VERIFY ON commands (for network and DOS copies respectively) to the login script.

Another option, since VERIFY ON can affect performance by slowing down write operations, is to use the /V option at the command line with each COPY or NCOPY operation.

The default in the login script is DOS VERIFY OFF.

These commands may not work with some software that is copy protected.

## DRIVE

Use **DRIVE** to change the default drive while the login script is executing.



On OS/2 workstations, **DRIVE** is effective only during execution of the login script. When the login script completes, you're returned to the drive in effect when the **LOGIN** command was issued.

### Command Format

**DRIVE** [*drive*: | \**n*: ]

Replace *drive* with a local or network drive letter, or replace *n* with a drive number. Use of either is dependant on their already being assigned within the login script.

### Using DRIVE

Unless this command is in your login script, the default drive is set to the first network drive, which is often assigned to your home directory when you log in.

If you don't want the default drive to be the first network drive, map a drive in the login script to the directory you want to be the default; then, use the **DRIVE** command to change the default drive.

Instead of specifying a drive letter such as F: or G:, you can use an asterisk followed by a number *n* to represent the *n*th network drive (for example, \*3). This allows drive letters to reorder themselves automatically if previous drive mappings are deleted or added.

### Example

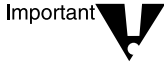
Suppose you expect to work on only one project for several days and the files for that project are located on drive S:. You can use the **DRIVE** command to set your default drive to S: so you won't have to change your default drive manually every time you log in.

First, make sure you've mapped drive S: to the correct directory in your login script. Then enter the following command in the login script:

```
DRIVE S:
```

## EXIT

Use EXIT to terminate execution of the login script and execute an external program.



This command does not apply to OS/2 workstations.

### Command Format

```
EXIT ["filename [parameters]"]
```

### Using EXIT

The length of information between quotes can't exceed your keyboard buffer length minus 1 (commonly  $15 - 1 = 14$  characters).

You can use the EXIT command in a login script to stop the login script and execute a program, such as a word processing or menu program.

Because EXIT stops the login script, make sure you put this command at the end of the login script.

You can also use EXIT in an IF...THEN statement, so that the login script stops and exits to an external program only if a certain condition exists. If the condition doesn't exist, the login script skips the EXIT command and continues executing.

If the program you are executing with the EXIT command requires any DOS paths or NetWare search drives to be set, make sure they are specified in the login script ahead of the EXIT command.

If you add EXIT to a container login script, it prevents other profile or user login scripts from running. If you put EXIT in a profile login script, it prevents the user login script from running.

The EXIT command works only on IBM-compatible workstations running DOS. Therefore, if your DOS workstation has a machine name different from IBM\_PC specified in its NET.CFG file, you must add the PCCOMPATIBLE login script command to the login script.

For more information about the PCCOMPATIBLE command, see "PCCOMPATIBLE" on page 221.

## Examples

- ◆ Suppose the workstation's long machine name is IBM\_PC. To execute a menu program called TRAINING when the login script is finished, add the following line at the end of the login script:

```
EXIT "NMENU TRAINING"
```

- ◆ If you are using a Hewlett Packard computer and you have changed the long machine name to HE\_PAC in the NET.CFG file, add the following lines at the end of the login script:

```
PCCOMPATIBLE  
EXIT "NMENU TRAINING"
```

- ◆ Suppose you want the login script to exit to a word processing program when the user logs in on Mondays, but not on other days. You could add the following IF...THEN statement to the login script:

```
IF DAY_OF_WEEK="MONDAY" THEN EXIT "WP"
```

## Additional Information

For more information about	See
Changing the machine name in NET.CFG	<i>NetWare Client for DOS and Windows User Guide</i>
Creating a menu	"Creating a Menu File" on page 820 in <i>Creating Menus</i>

## FDISPLAY

Use FDISPLAY to show the text of a word processing file on a workstation's screen when the user logs in.

To display both the text and the printer and word processing codes of a file, or to display an ASCII file, see "DISPLAY" on page 194.

## Command Format

```
FDISPLAY [path] filename
```

Replace *path* with either a drive letter or a full directory path beginning with the NetWare volume name.

Replace *filename* with the complete name (including the extension) of the file you want to display.

## Using FDISPLAY

When you use FDISPLAY to display the contents of a word processing file on the screen, the text in the file is filtered and formatted so that only the text itself is displayed. FDISPLAY will not display tabs.

If the given directory does not exist or if the file is not found, no error message appears on the screen when the user logs in.

## Example

Suppose you put messages in a file called SYSNEWS.TXT, in the directory SYS:PUBLIC\MESSAGES, and you want your users to see this file on their screens when they log in on Mondays.

Add the following lines to the container login script:

```
IF DAY_OF_WEEK="Monday" THEN  
    FDISPLAY SYS:PUBLIC\MESSAGES\SYSNEWS.TXT  
END
```

## FIRE PHASERS

FIRE PHASERS signals the workstation to emit a phaser sound.

## Command Format

```
FIRE n
```

Replace *n* with the number of times you want this sound to occur.

## Using FIRE PHASERS

Use this command by itself to generate the phaser sound whenever a user logs in. Use FIRE PHASERS with the IF...THEN command to make the sound execute a different number of times depending on the circumstances of the login.

### Example

The following line executes the phaser sound four times upon login:

```
FIRE 4
```

To use an environment variable as the number of times to fire, use % before the variable, as follows:

```
FIRE %environment variable
```

Either of the following lines fires the phaser five times on Thursdays:

```
IF DAY_OF_WEEK="Thursday" THEN FIRE 5
```

or

```
FIRE %NDAY_OF_WEEK
```

The identifier variable %NDAY\_OF\_WEEK indicates a number that corresponds to the day of the week. Since Thursday is the fifth day of the week, phasers fire five times on Thursdays.

For more information about using identifier variables, see “Identifier Variables” on page 234.

## GOTO

Use GOTO to execute a portion of the login script out of the regular sequence.

### Command Format

```
GOTO label
```

Use *label* to indicate where the login script should continue executing.

### Using GOTO

Set BREAK ON in your login script before experimenting with GOTO loops so that you can break out of a login script if necessary.

For more information about the BREAK login script command, see “BREAK” on page 190.



Do not use GOTO to enter or exit a nested IF...THEN statement. This usage confuses the program.

### Example

To execute a loop of commands, you could include the following lines in your login script. In this case, the commands to be executed are labeled AGAIN (as indicated in the second line).

```
SET X="1"  
AGAIN:  
SET X=<X> + "1"  
;see compound strings for this  
WRITE <X>  
IF <X> < "9" THEN GOTO AGAIN
```

The GOTO command looks at the value of <X> (a DOS environment variable). If the value of <X> is less than 9, then <X> increments by 1 and GOTO loops back to the AGAIN label. When <X> gains the value of 9, the IF...THEN test becomes false, the GOTO is ignored, and the script continues normally. See the IF...THEN command below.



## IF...THEN

Use IF...THEN when you want the login script to perform an action only under certain conditions.

### Command Format

```
IF conditional [AND|OR [conditional]] THEN  
    commands  
[ ELSE  
    command]  
[ END ]
```

Replace *conditional* with identifier variables. For more information about identifier variables, see “Identifier Variables” on page 234.

Replace *commands* with any login script commands that you want to be executed if the specified condition is true.

### Using IF...THEN

- ◆ Use IF...THEN statements to execute commands only under certain conditions.

An example of a conditional statement is

```
IF MEMBER OF "CLERKS"
```

In this statement, some action is performed if the user who logged in belongs to the Group object named CLERKS.

The following is a different type of conditional statement:

```
IF DAY_OF_WEEK="MONDAY"
```

In this statement, the equal sign (=) indicates the relationship between the variable (DAY\_OF\_WEEK) and its value (Monday). Note that the value (Monday) is inside quotation marks.

- ◆ When using IF...THEN statements, be aware of the following syntax rules:
  - ◆ Use AND or OR to include two or more conditionals in an IF...THEN statement.
  - ◆ Values of conditional statements must be enclosed in quotation marks.
  - ◆ The ELSE statement is optional.
  - ◆ IF, ELSE, and END must be on separate lines. THEN does not need to be on a separate line.
  - ◆ If you include a WRITE command as part of the IF...THEN command, the WRITE command must be on a separate line.
  - ◆ IF...THEN statements can be nested (up to 10 levels). However, GOTO should not be used in a nested IF...THEN statement to enter or exit from the body of an IF...THEN statement.
  - ◆ If your IF...THEN statement consists of only one line, even if that line wraps, you do not need to include END. If your IF...THEN statement must be on more than one line (for example, you used ELSE or WRITE, which must be on separate lines), you must include END.

Six relationships are possible between the elements of an IF...THEN statement. Represent these relationships with the following symbols:

Symbol	Definition
=	Equals
<>	Does not equal
>	Is greater than
>=	Is greater than or equal to
<	Is less than
<=	Is less than or equal to

## Examples

- ◆ If you place the following command in a login script, the message “Status report is due today” appears when the user logs in on Monday and “Have a nice day!” on other days.

```
IF DAY_OF_WEEK="MONDAY" THEN
    WRITE "Status report is due today"
ELSE
    WRITE "Have a nice day!"
END
```

- ◆ The following line means “If the hour (on a 24-hour scale) is greater than or equal to 12, then write ‘afternoon’.”

```
IF HOUR24>="12" THEN
    WRITE "afternoon"
END
```

- ◆ The following command executes the CAPTURE utility on the fourth day of the week (Wednesday):

```
IF NDAY_OF_WEEK="4" THEN
    #CAPTURE Q=FAST_Q NB TI=10 NFF
END
```

- ◆ The following example shows nested IF...THEN statements. Notice that there are two IF statements, so each one must have its own END statement.

```
IF DAY_OF_WEEK="MONDAY" THEN
    MAP *6:=VOL1:APPL\WP
    IF MEMBER OF CLERKS THEN
        WRITE "Your report is due immediately!"
    END
END
```

- ◆ Conditionals can be joined with commas, the word AND, or the word OR to form compound conditionals.

The first line of the following IF...THEN statement is a compound conditional that means "If it is the evening of the first day of the month":

```
IF GREETING_TIME="EVENING" AND DAY="01" THEN
    WRITE "The system will be backed up tonight."
END
```

The following line is a compound conditional that means "If it is 11:59:59 p.m.":

```
IF HOUR24="23" AND MINUTE="59" AND SECOND="59"
```

- ◆ An IF...THEN statement can include several commands that must be executed if the conditional is true.

The following example shows two commands that are executed on Tuesdays: a WRITE command that displays a message about a staff meeting, and an INCLUDE command that tells the login script to process any commands or messages contained in the file SYS:PUBLIC\UPDATE.

```
IF DAY_OF_WEEK="TUESDAY" THEN
    WRITE "Staff meeting today at 10 a.m."
    INCLUDE SYS:PUBLIC\UPDATE
END
```

### Additional Information

For more information about	See
Using identifier variables	"Identifier Variables" on page 234
Using the WRITE login script command to display messages	"WRITE" on page 232

## INCLUDE

Use INCLUDE to execute independent files or another object's login script as a part of the login script currently being processed.

These sub-scripts can be text files that contain valid login script commands (any of the commands explained in this section) or login scripts that belongs to a different object you have rights to.

## Command Format

```
INCLUDE [path]filename
```

or

```
INCLUDE object_name
```

To use a text file as a sub-script, replace *path* with either a drive letter or a full directory path beginning with the NetWare volume name.

Replace *filename* with the complete name (including the extension) of the text file.

To execute another object's login script as part of a login script, replace *object\_name* with the name of the object whose login script you want to use.

## Using INCLUDE

Text files that contain login script commands and other object's login scripts can be used as sub-scripts. Use these sub-scripts to supplement the main login script.

You can create and edit text file sub-scripts using any text editor. Sub-scripts do not have to have any particular filenames or extensions.

The INCLUDE command executes the login script commands contained in the sub-script. It does not display the text of the sub-scripts.

INCLUDE nesting is limited only by available memory. This means that one sub-script file can include another sub-script file, which can include yet another sub-script file, and so on.

If the sub-script is a text file, users must have at least File Scan and Read rights to the directory containing the sub-script.

If you are using another object's login script as a sub-script, users must have the Browse right to the object whose script you are including, and the Read right to the object's Login Script property.

## Examples

- ◆ To execute a text file called SCRIPT.NEW (located in the VOL1: volume) as a sub-script, add the following line to your main login script:

```
INCLUDE VOL1:ADMIN\USERS\SCRIPT.NEW
```

- ◆ Suppose you are creating a container login script for all users under the Organizational Unit object SALES\_LA. You recently created a container login script for users under the Organizational Unit object SALES\_PV.

Now you've decided that the login scripts for the two different groups of users are very similar. In fact, you decide that the SALES\_LA users could use the same login script as the SALES\_PV users, but with a few more drive mappings.

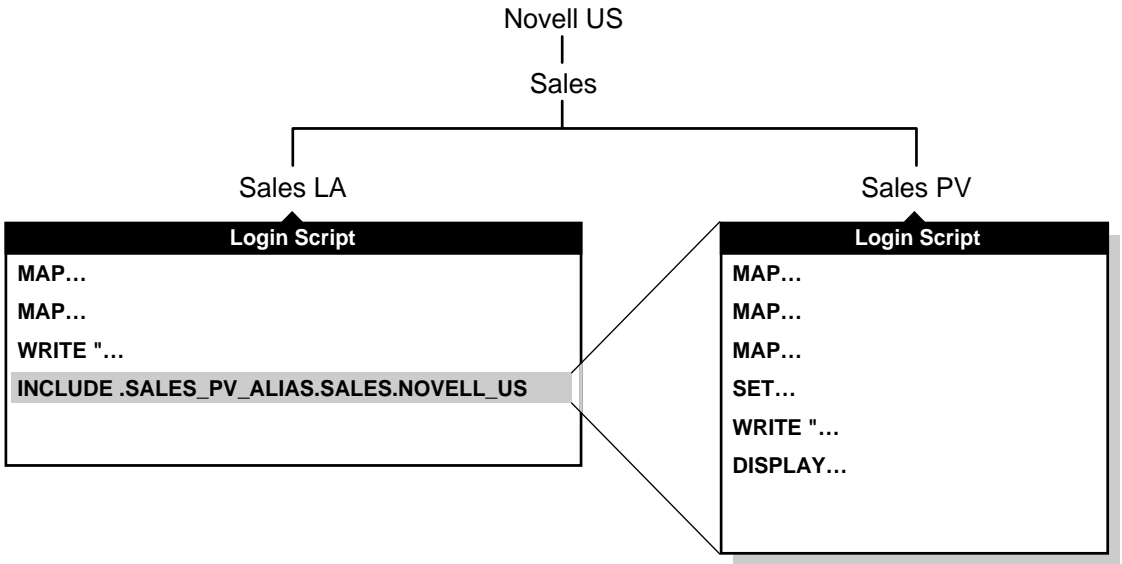
In the SALES\_LA login script, you could add the additional drive mappings, and then use the INCLUDE command to execute the entire SALES\_PV login script as a part of the SALES\_LA login script, as follows:

- ◆ Create an alias for the SALES\_PV Organizational Unit in the SALES\_LA Organizational Unit.
- ◆ Add this line to the SALES\_LA Organizational Unit's login script.

```
INCLUDE .SALES_PV_ALIAS.SALES.NOVELL_US
```

Figure 3-2 illustrates how the INCLUDE command executes the SALES\_PV login script as part of the SALES\_LA login script.

Figure 3-2  
Using INCLUDE in a Login Script



## LASTLOGINTIME

Use LASTLOGINTIME to display the last time the user logged in.

### Command Format

```
LASTLOGINTIME
```

### Using LASTLOGINTIME

If you include this command in your login script, the time of the last login is displayed on the user's workstation screen.

# MACHINE

Use MACHINE to set the DOS machine name (such as IBM or EDIT\_ROOM) of the workstation. The MACHINE command is necessary for some programs (such as NETBIOS) written to run under PC DOS.

The MACHINE command does not apply to OS/2 workstations.



Do *not* confuse the MACHINE command with the identifier of the same name. The identifier is used with a preceding percent (%) sign in MAP and WRITE statements. The identifier reads its value from the NET.CFG file.

It is unlikely that you will need to use this command. However, it is provided in case you come upon a program that requires it.

## Command Format

**MACHINE**=*name*

## Using MACHINE

The machine name can be up to 15 characters. (Longer machine names are truncated to 15 characters.)

For example, to specify that the machine name is IBM\_PS2, add the following line to the login script:

**MACHINE=IBM\_PS2**

## Additional Information

For more information about	See
Setting machine names in the NET.CFG file	<i>NetWare Client for DOS and Windows User Guide</i>
Using identifier variables	"Identifier Variables" on page 234

# MAP

Use MAP to map drives and search drives to network directories.



## Command Format

**MAP** [*option*] [*drive:=path*]

Replace *drive* with any valid network drive letter, local drive letter, or search drive number.

Replace *path* with either a drive letter, a full directory path, or a Directory Map object.

More than one command can be on the map line if the commands are separated by a semicolon (;), as shown in the following example:

```
MAP *1:=SYS:PUBLIC;*2:=SYS:PUBLIC\DOS
```

When mapping a drive to a directory on a Novell Directory Services (NDS™) server, begin the path with either the Volume object name or server/volume.

When mapping to a directory on a bindery-based server or to an NDS server that isn't your current server, begin the path with the server's name.

Replace *option* with one of the following:

- ◆ **DISPLAY ON/OFF:** Determines whether drive mappings are displayed on the screen when the user logs in. The default setting is ON. This option is valid only in login scripts.
- ◆ **ERRORS ON/OFF:** Determines whether MAP error messages are displayed when the user logs in. MAP ERROR OFF must be placed before MAP commands in the login script. The default setting is ON. This option is valid only in login scripts.

- ◆ **INS:** Inserts a drive mapping between existing search mappings. This option is valid in login scripts and at the DOS command line.
- ◆ **DEL:** Deletes a drive mapping, making that drive letter available for other mapping assignments. This option is valid in login scripts and at the command line.
- ◆ **ROOT:** Maps a fake root. OS/2 is always mapped to the root. Some applications require their executable files to be located in a root directory.

Since you may not want users to have rights at the root directory, you can map a fake root to a subdirectory instead. This option is valid in login scripts and at the command line.

- ◆ **C (CHANGE):** Changes a search drive mapping to a regular mapping, and a regular mapping to a search drive mapping. This option is valid in login scripts and at the command line.
- ◆ **NP (No prompt):** When a MAP command conflicts with an existing drive mapping, MAP NP eliminates the prompt that asks the user if the new drive mapping should overwrite the old mapping.

This option is valid only at the command line.

- ◆ **P (Physical):** Maps a drive to the physical volume of a server, rather than to the Volume object's name.

It is possible to have a Volume object name that conflicts with a physical volume name. (For example, object ACCT is an Accounting volume, but there is also an ACCT which is a physical volume.)

Therefore, if you prefer to map a drive to the physical volume name, use MAP P. This option is valid in login scripts and at the command line.

- ◆ **N (Next):** When used without specifying a drive number or letter, maps the next available drive. This option is valid in login scripts and at the command line.

## Using MAP

- ◆ If you use MAP to automate drive map assignments during execution of the login script, users don't have to manually map drives every time they log in.
- ◆ Specify drive mappings in a login script by entering the same commands that you would enter if you were using MAP at the command line.
- ◆ To avoid having the result of each mapping displayed as it is executed, you can put the MAP DISPLAY OFF command at the beginning of your login script. When all drive map assignments have been completed, add the line MAP DISPLAY ON and MAP to your login script. This sequence provides a cleaner display for the users as they log in.
- ◆ Instead of specifying drive letters such as F: or G:, you could use an asterisk followed by a number *n* to represent the *n*th network drive. For example, if your first network drive is F: then using MAP \*3:= would assign H: {F G H—1 2 3}, or if your first network drive is D: then using MAP \*4:= would assign G: {D E F G—1 2 3 4}.

This allows drive letters to reorder themselves automatically when local drives are removed or added or when the first network drive is changed.

This also allows users to log in from workstations with a different number of local drives than their regular workstation.

- ◆ You can map a local drive (usually A: through C:) to a network directory, but you cannot access the local drive until you remove the network drive mapping.
- ◆ You must not map a redirected drive, such as a CD-ROM drive, to a network drive.

- ◆ In many cases, you might find it useful to map network drives in the following order:
  - ◆ Map the first network drive to the user's home directory.
  - ◆ If your users are running OS/2, map network drive P: to the SYS:PUBLIC directory.

This drive mapping is used by OS/2 workstations, as explained in *NetWare Client for OS/2 User Guide*.

- ◆ If users are running MS Windows from the network, map a drive to each user's directory that contains user-specific files.
- ◆ Map remaining drives to any directories that users work in frequently, such as project directories.

## Mapping Search Drives



OS/2 workstations do not use search drives. Instead, OS/2 users use the OS/2 commands PATH, DPATH, and LIBPATH in their CONFIG.SYS files.

For DOS and MS Windows workstations, you can map search drives to directories that contain applications, executable files, and so forth. Then users can execute those applications regardless of the directory they are currently working in.

A maximum of 16 NetWare search drives are allowed.



Any object names in the login script should either be in the user's context or should have an alias point to the real object in another context. Any object referenced by a name outside the user's context will break when that object is moved or renamed, or the context is renamed. See "Alias object" in *Concepts*.

When you map a search drive, use a search drive number (an S followed by a number). This search drive number assigns the next available drive letter to the mapping, starting with Z and working backwards through the English alphabet.

The letter assigned to the search drive is put into the DOS path statement. If you already have search drives in the path statement, the command MAP S1: will overwrite the first one in the path. To prevent search drive assignments from overriding existing DOS PATH letters, use the INSERT option when assigning search drives. For example, type

```
MAP INS S16:=path
```

To ensure that users can access NetWare utilities, DOS directories, and applications, we recommend you map search drives to these directories in the following order:

- ◆ Map the first search drive (S1:) to the SYS:PUBLIC directory, which contains the NetWare utilities for DOS and MS Windows workstations.
- ◆ Map the second search drive (S2:) to the DOS directory if users access DOS from the network.
- ◆ Map the third and subsequent search drives (S3:, S4:, etc.) to directories containing applications and the electronic NetWare documentation.
- ◆ If your users are running MS Windows from the network, map a search drive to the MS Windows directory for the MS Windows group.

To avoid inadvertently changing the order of any search drives that must be mapped to a specific drive letter, you can map all remaining search drives with the number S16:, which assigns the next lowest search number each time it is used.

This command assigns the next available drive letter to the search drive, without displacing the previous search drives.

If you have an application that requires a particular drive letter, you can use the following command to map the search drive, replacing *drive* with the drive letter:

```
MAP S16:=drive:=path
```

If you map a search drive using a number already assigned to a search drive, NetWare makes the old search drive a network drive. The letter assigned to the old search drive remains assigned as the converted drive mapping. The new search drive takes the next unused letter of the alphabet.

## Mapping Drives to Directory Map Objects

Another way to map a drive to a directory is to create a Directory Map object that points to the directory. Then, if you move the directory, you only need to change the Directory Map object rather than all of the login scripts that may include that mapping.



It is best to use map objects in the user's current context. Don't use complete names that point to other contexts. If the map is in another context, you should create an alias that points to the real directory map object. See "Alias object" in *Concepts*.

For example, to map a search drive to a Directory Map object whose complete name is APPL.SALES\_LA.NOVELL\_US, add the following line to the login script:

```
MAP S2: = .APPL.SALES_LA.NOVELL_US
```

In the above example, the Directory Map object's name begins with a period, which indicates that the drive is mapped to the drive root.

If the user whose login script this line appears in is also located in the SALES\_LA.NOVELL\_US context, the MAP command does not have to specify the Directory Map object's complete name. Instead, the line would be

```
MAP S2: =APPL
```

For more information about using Directory Map objects, see "Loading Operating Systems and Applications onto the Network" on page 109.

## Examples

- ◆ To map the first search drive to the SYS:PUBLIC directory (which contains the NetWare utilities for DOS and MS Windows workstations) add the following line to the login script:

```
MAP S1: =SYS:PUBLIC
```

The second search drive should be mapped to the DOS directory if users run DOS from the network.

- ◆ If your network has more than one DOS directory, use variables to indicate the directory path. These variables are replaced by the correct information from the workstation software when each user logs in.

To use variables for the DOS directory path, enter the following command in the login script:

```
MAP S2:=SYS:PUBLIC%\%MACHINE%\%OS%\%OS_VERSION
```

- ◆ If all users have the same types of computers and are using the same version of DOS, you probably only have one DOS directory. In this case, add a line similar to the following, substituting the correct directory names:

```
MAP S2:=SYS:PUBLIC\IBM_PC\MSDOS\50
```

You can also create a Directory Map object that points to the DOS directory, then map the search drive to the Directory Map object.

For more information about creating DOS directories, see “Loading DOS onto the Network” on page 109.

- ◆ To map the next available search drive to the SYS:APPL\WORDPROC directory, add the following line to the login script:

```
MAP S16:=SYS:APPL\WORDPROC
```

If you have mapped a Directory Map object to this directory, you can substitute the Directory Map object’s name for the directory path.

For example, suppose you created a Directory Map object called WPROC, which is located in the context SALES.NOVELL\_US, and mapped that object to the SYS:APPL\WORDPROC directory.

Following the rule of no complete names in a login script, you would create an alias in your own context to the object in .SALES.NOVELL\_US. Then use the following line in your login script:

```
MAP S16:=WPROC
```

- ◆ Suppose an application in the FORM directory requires that it reside in the root directory of drive P:, but you don't want to put the application in the root directory for security reasons.

You can map a fake root to the directory and map a search drive to it at the same time by adding the following line to the login script:

```
MAP ROOT S16:=P:=SYS:APPL\FORM
```

- ◆ To map Richard's first four regular drive mappings to his home directory, the SYS:PUBLIC\OS2 directory (which contains the NetWare utilities for OS/2), the REPORTS directory, and the PROJECTS directory, add the following four lines to Richard's user login script:

```
MAP *1:=VOL1:HOME\RICHARD
MAP *2:=SYS:PUBLIC\OS2
MAP *3:=VOL1:ACCOUNTS\REPORTS
MAP *4:=VOL1:UPDATES\PROJECTS
```

To map Richard's fifth drive to the PUBLIC directory on a NetWare 3.11 server named FS1, you need to include the server name in the MAP command. Use the following line in your login script:

```
MAP *5:=FS1\SYS:PUBLIC
```

- ◆ If you are mapping a drive to a directory that is located on a volume within your current context, include the volume's common name in the MAP command, as demonstrated in the previous examples.

If you are mapping a drive to a volume that is not in your current context, first create an alias to that volume; then include the volume's common name in the MAP command.

For example, if the complete name of a volume not in your current context is VOL1.SALES.NOVELL\_US, then create an alias named VOL1: to that volume. The MAP command would include only this common name.

To map a drive to the APPL directory in this volume, the line in the login script would be

```
MAP *6:=VOL1:APPL
```



## Additional Information

For more information about	See
Drive mappings	“Drive mapping” in <i>Concepts</i>
Enabling users to run DOS from the network	“Loading DOS onto the Network” on page 109
Setting paths for OS/2 workstations	<i>NetWare Client for OS/2 User Guide</i>
Using Directory Map objects	“Loading Operating Systems and Applications onto the Network” on page 109

## NO\_DEFAULT

Use `NO_DEFAULT` in a container or profile login script if you do not want the default user login script to run.

### Command Format

`NO_DEFAULT`

### Using NO\_DEFAULT

If you do not want to create any user login scripts, and you do not want the default user login script to run, add this command to either the container or the profile login script.

If you have created a user login script for someone, that login script executes whether or not the `NO_DEFAULT` command is in the container or profile login script.

## NOSWAP

Use NOSWAP to prevent the LOGIN utility from being moved out of conventional memory into higher memory (if available) or onto the disk to execute a # command and LOGIN at the same time.

### Command Format

**NOSWAP**

### Using NOSWAP

LOGIN always swaps to extended or expanded memory unless NOSWAP is specified on the command line or in the login script.

If you do not want LOGIN to be temporarily stored in higher memory or on the workstation's disk, use the NOSWAP command. NOSWAP prevents LOGIN from being swapped out of conventional memory.

Then, if the workstation does not have enough memory to handle both LOGIN and the # command, the # command fails but the rest of the login script executes as usual.

If you want LOGIN to be swapped out of conventional memory immediately every time a # command is executed, place the SWAP command in the login script, before the # command.

### Additional Information

For more information about	See
Using the # command	"# (Execute External Program)" on page 188
Using the SWAP command	"SWAP" on page 230

## PAUSE

Use PAUSE to create a pause in the execution of the login script.

### Command Format

**PAUSE**

### Using PAUSE

Enter this command in your login script at any point you want a pause to occur.

You can add PAUSE to the login script following a message so that the user has time to read the message before it scrolls off the screen.

If you include PAUSE, the message “Strike any key when ready...” appears on the workstation screen. The LOGIN utility then waits for a key to be pressed before it executes the rest of the login script.

## PCCOMPATIBLE

Use PCCOMPATIBLE to enable the EXIT “*command*” login script command to work if your workstation’s LONG MACHINE NAME is not IBM\_PC.

This command does not apply to OS/2 workstations.

### Command Format

**PCCOMPATIBLE**

## Using PCCOMPATIBLE

If your computer is an IBM PC compatible machine and not an IBM PC, use PCCOMPATIBLE in your login script to inform the LOGIN utility that your machine's long name is something other than IBM\_PC. The LONG MACHINE NAME (AT&T, COMPAQ, or others) must be included in the NET.CFG file.

Place the following anywhere before EXIT in the login script:

```
PCCOMPATIBLE
```

### Example

If you have a Hewlett Packard computer and you have changed the LONG MACHINE NAME to HE\_PAC in the NET.CFG file, and you want to exit to NETADMIN from within your login script, put the following commands in your login script:

```
PCCOMPATIBLE  
EXIT "NETADMIN"
```

### Additional Information

For more information about	See
Setting the machine name in NET.CFG	<i>NetWare Client for DOS and Windows User Guide</i>
Using the EXIT command	"EXIT" on page 198

## PROFILE

Use PROFILE in a container script to set or override a user's assigned or command-line-specified profile script. It is useful when defining a group profile.

### Command Format

```
PROFILE profile_object_name
```

## Example

To override the profile script assigned to a user or specified at the command line, and cause the user to execute a PROFILE script called *team\_profile*, use the following command:

```
PROFILE team_profile
```

## REMARK

Use REMARK to insert explanatory text into your login script. This text does not display on the screen.

## Command Format

```
REM[ARK] [text]
```

or

```
* [text]
```

or

```
;  
[text]
```

Replace *text* with the comment you want to include in the login script.

## Using REMARK

To include explanatory text in your login script, begin a line with REMARK, REM, an asterisk (\*), or a semicolon (;).

Any text that follows these symbols is ignored when the LOGIN command executes your login script. Remarks do not appear on the screen.

Using remarks in your login script can make the script much easier for you or other users to read and understand.

The REMARK command and its associated text must be the only entry on a line. Placing remarks on the same line as other login script commands can cause errors.

If a remark is several lines long, begin each line with the remark keyword (REMARK, REM, an asterisk, or a semicolon).

## Example

The following are examples of explanatory text that you might use with the REMARK command and its variants:

```
* This is Richard's login script
; Mapped network drives follow:
REM The next mapping is a fake root.
REMARK This login script is for new users.
```

## SCRIPT\_SERVER

NetWare 2 and 3 users can use SCRIPT\_SERVER to set a home server from where the bindery login script is read.



SCRIPT\_SERVER has no effect on NetWare 4 users.

### Command Format

```
SCRIPT_SERVER server_name
```

### Using SCRIPT\_SERVER

This command has no effect on Novell Directory Services.

## SET

Use SET to set a DOS or OS/2 environment variable to a specified value.

For OS/2 workstations, SET commands affect the environment only while the login script is running; the settings disappear when LOGIN terminates.

## Command Format

```
[TEMP] SET name="value"
```

Replace *name* with an environment parameter that identifies the environment you want to change.

Replace *value* with identifier variable substitutions. Values must be enclosed in quotation marks.

To change the environment for the login script, but not for the workstation itself after the login script has finished executing, use the optional keyword TEMP.



Variables set in the login script for an OS/2 workstation affect the environment only while the login script is running. Therefore, the TEMP option does not work with OS/2 workstations.

## Using SET

Use the SET login script command the same way you use the DOS command called SET. However, when you use SET in a login script, you must enter quotation marks (“ ”) around values.



If a variable is set to a path that ends in a \”, these two characters are interpreted as an embedded quote preceded by an escape character. To avoid this problem, use two backslashes before the ending double quotes (\\”).

SET commands do not have to be included in login scripts.

For example, you may decide that it is easier to put some SET commands in the workstation’s AUTOEXEC.BAT file. Where you use SET commands depends upon your individual needs.

For information about values you can set, see the SET command in your DOS or OS/2 documentation.

This command does not work in a login script if the DOS workstation’s environment is too small. In this case, you should set the environment size in the CONFIG.SYS file.

See the SHELL command in your DOS manual for more information about the environment size. (OS/2 workstations do not have this limitation.)

After you use the SET command to set a value for an environment variable, you can use that variable in other login script commands.

To include an environment variable as an identifier variable in a command, enclose the name of the variable in angle brackets; for example, <emailuser>.

## Examples

- ◆ You can use SET to make a prompt display the current directory path, such as F:\HOME\MARY>, rather than just the drive letter. To do this, add the following line to the login script:

```
SET PROMPT="$P$G"
```

"\$P" lists the current directory path; "\$G" displays a ">" (greater than) character. See your DOS or OS/2 manual for more information.

- ◆ To set a path for a program called DAILY, which is in the REPORTS subdirectory beneath drive G:, you would add the following line:

```
SET PATH="G:\REPORTS\DAILY"
```

This sets the variable PATH to G:\REPORTS\DAILY.



Setting the variable PATH in the login script removes any search drives previously assigned. Use SET PATH only before you map search drives. SET PATH also overwrites any paths set in the user's AUTOEXEC.BAT file.

To display this path, you can include PATH as an identifier variable in a WRITE command by enclosing the variable (not the value) in angle brackets. For example, the following line displays "My path is G:\REPORTS\DAILY"

```
WRITE "My path is "%<path>
```



- ◆ To include an environment variable in a MAP command, precede the variable with a percent sign (%).

For example, you could include the following lines in a login script to set and map a drive to the variable NWS:

```
SET NWS="C:\XYZ"  
MAP S16 :=%<NWS>
```

### Additional Information

For more information about	See
Using environment variables as identifier variables in other login script commands	"Identifier Variables" on page 234
Using the SET command	Your DOS or OS/2 manual

## SET\_TIME

Use SET\_TIME to set the workstation time equal to the time on the NetWare server that the workstation first connects to.

### Command Format

```
SET_TIME ON|OFF
```

### Using SET TIME

The default value is SET\_TIME ON, which means the workstation time is set to the NetWare server time whenever the user logs in. If you include SET\_TIME OFF in the login script, the workstation time does not update to the server's time.

## SHIFT

Use **SHIFT** to change the order in which *%n* identifier variables are interpreted in the login script. **SHIFT** allows users to enter **LOGIN** parameters in any order.

### Command Format

**SHIFT** [*n*]

Replace *n* with the number of places you want the variable to shift. The default is **SHIFT** 1.

### Using SHIFT

You can shift up to 10 arguments.

When users execute **LOGIN**, they can include additional parameters. Each of these parameters is assigned a *%n* variable; in this way, the parameter's real value can be substituted for the *%n* variable that appears in the login script.

In the login script, you can add **SHIFT** with a positive or negative number to move the variables in either direction. For example, **SHIFT - 3** moves each *%n* variable three positions to the left.

### Example

When Mary logs in, she wants to access her word processing program, change the way it is set up, and map a drive to her work directory called **ACCNTS**.

Mary also has a command in her login script to map a drive to her LOTUS directory, but she does not need it today. The commands in Mary's login script are shown here.

```
LOOP
IF "%2"="WP" THEN
    SET WP="\U-CML\B-10\D"
    MAP S16:=SYS:APPL\WP\SETUP
IF "%2"="ACCNTS" THEN
    MAP G:=SYS:ACCNTS
IF "%2"="LOTUS" THEN
    MAP S16:=SYS:APPL\LOTUS
SHIFT
IF "%2"<>" THEN GOTO LOOP
```

(In the last line, "IF "%2" <>" is followed by closed quotation marks, which means "If %2 isn't blank".)

With these commands in her login script, Mary can log in to the primary file server (named FS1) using her username, MARY, as follows:

```
LOGIN FS1\MARY WP ACCNTS
```

The parameters in Mary's LOGIN command are given the following values:

```
%0=FS1
%1=MARY
%2=WP
%3=ACCNTS
```

Mary's login script looks for %2, which is WP, and sets the word processing environment. Then the login script shifts the variables one to the right so that %2 now becomes ACCNTS. Upon executing the loop, the login script maps a drive to the ACCNTS directory.

Mary could also change the order of her LOGIN command without affecting the way her work environment is set up, as follows:

```
LOGIN MARY ACCNTS WP
```

The parameters in this LOGIN command are given the following values:

%0=FS1  
%1=MARY  
%2=ACCNTS  
%3=WP

In this case, Mary's login script looks for %2, which is now ACCNTS.

The login script maps a drive to the ACCNTS directory. Then the login script shifts the variables to the right so that %2 now becomes WP.

Upon executing the loop, the login script sets the word processing environment.

### Additional Information

For more information about	See
Using %n variables in login scripts	Table 3-6 on page 235

## SWAP

Use SWAP to move the LOGIN utility out of conventional memory into higher memory (if available) or onto the disk. This allows execution of a # command and LOGIN at the same time.

### Command Format

**SWAP** [*path*]

You can replace *path* with either a drive letter or a full directory path beginning with the NetWare volume name.

### Using SWAP

By default, the LOGIN utility always swaps to extended or expanded memory, unless NOSWAP is specified on the command line or in the login script.



The SWAP option doesn't work with the DR DOS 6.0 EMM386 Memory Manager option unless upper memory is disabled.

If you specify a path in the SWAP command, LOGIN swaps into the directory you specified. If the directory specified in that path does not exist or if you do not have rights there, LOGIN prompts you for another path.

If you don't specify a path, LOGIN swaps either into higher memory (if available) or to the current drive. If LOGIN tries to swap to the current drive and you don't have rights to the current drive, LOGIN prompts you for a path to use. If you specify a valid path, LOGIN always swaps to the specified path.

Then, if the workstation doesn't have enough memory to handle both LOGIN and the # command, the # command fails but the rest of the login script executes as usual.

### **Additional Information**

---

<b>For more information about</b>	<b>See</b>
Using the # command	"# (Execute External Program)" on page 188
Using the NOSWAP command	"NOSWAP" on page 220

---

## **TEMP SET**

See "SET" on page 224.

## WRITE

Use WRITE to display messages on the workstation screen when a user logs in.

### Command Format

```
WRITE "[text][%identifier]" [;][identifier]
```

Replace *text* with the words you want to display on the screen.

Replace *identifier* with a variable you want to display, such as a user's login name. (See "Using Identifier Variables" on page 238 for a complete list of variables.)

### Using WRITE

Text you want to display must be enclosed in quotation marks ("").

There are several ways to display variables in the text message. The way you enter the variable in the WRITE command determines the display format, as follows:

- ◆ If you type the identifier variable exactly as shown, with no special punctuation, only the variable is displayed on the screen. (See Table 3-6 on page 235)
- ◆ If you enclose the identifier variable inside quotation marks, precede the variable with a percent sign (%), and type it in uppercase letters.

This method is often used to combine regular text with an identifier variable because both the text and the variable can be enclosed in the same quotation marks.

To join several text strings and identifier variables into a single display without enclosing the variables in quotation marks, use a semicolon between the text and the variables.

If you have several WRITE commands, each one appears on a separate line on your workstation. However, if you put a semicolon at the end of all but the last WRITE commands, the displays all appear as one continuous sentence or paragraph (although they may wrap onto additional lines on the workstation's screen).

Text strings can include the following special characters:

Table 3-4

Character	Meaning
\r	Makes a carriage return occur
\n	Starts a new line of the text
\"	Displays a quotation mark on the screen
\7	Makes a beep sound

In addition to the semicolon, there are additional operators you can use to form compound strings (in other words, to join text and identifier variables into one command). These operators are listed in the following table, in order of precedence.

Table 3-5

Operator	Meaning
* / %	Multiply, divide, modulus
+ -	Add, subtract
>> <<	Shift left or right (1000 >> 3 becomes 1)

## Examples

- ◆ To display the message "Hello," add the following line to the login script:

```
WRITE "Hello"
```

- ◆ To display the user's last name (surname) along with a greeting, add the identifier `LAST_NAME` to the command. To do this, either join the text and the identifier with a semicolon or include the variable in the quotation marks with the text.

Either of the following lines displays "Hello, Smith" when user Bob Smith logs in:

```
WRITE "Hello, " ;%LAST_NAME  
WRITE "Hello, %LAST_NAME"
```

- ◆ To make a beep sound occur while the phrase "Good morning" appears on the screen, add the following line to the login script:

```
WRITE "Good %GREETING_TIME \7"
```

## Identifier Variables

With many login script commands, you can take advantage of identifier variables to make your login script more efficient and flexible.

Identifier variables allow you to enter a variable (such as `LAST_NAME`), rather than a specific name (such as Smith) in a login script command. When the login script executes, it substitutes real values for the identifier variables.

By using the variable, you can make the login script command applicable to many users instead of limiting it to one user.

For example, the command

```
WRITE "Hello, "%LAST_NAME
```

displays the following message on Bob's Smith's workstation screen when he logs in:

```
Hello, SMITH
```

Similarly, when Mary Jones logs in, the message she sees is

```
Hello, JONES
```

In the previous example, when the user logged in, the user's actual last name was substituted for the `LAST_NAME` variable in the command.



Table 3-6 lists all the available identifier variables.

**Table 3-6**  
**Login Script Identifier Variables**

Category	Identifier Variable	Function
Date	DAY	Day number (01 through 31)
	DAY_OF_WEEK	Day of week (Monday, Tuesday, etc.)
	MONTH	Month number (01 through 12)
	MONTH_NAME	Month name (January, February, etc.)
	NDAY_OF_WEEK	Weekday number (1 through 7; 1=Sunday)
	SHORT_YEAR	Last two digits of year (94, 95, 96, etc.)
	YEAR	All four digits of year (1994, 1995, 1996, etc.)
Time	AM_PM	Day or night (am or pm)
	GREETING_TIME	Time of day (morning, afternoon, or evening)
	HOUR	Hour (12-hour scale; 1 through 12)
	HOUR24	Hour (24-hour scale; 00 through 23; 00=midnight)
	MINUTE	Minute (00 through 59)
	SECOND	Second (00 through 59)
User	%CN	User's full login name as it exists in NDS
	LOGIN_ALIAS_CONTEXT	"Y" IF REQUESTER_CONTEXT is an Alias
	FULL_NAME	User's unique username. It is the value of the FULL_NAME property for both NDS and bindery-based NetWare. Spaces are replaced with underscores
	LAST_NAME	User's last name (surname) in Novell Directory Services, or full login name in bindery-based NetWare
	LOGIN_CONTEXT	Context where user exists

Table 3-6 *continued*

**Login Script Identifier Variables**

Category	Identifier Variable	Function
	LOGIN_NAME	User's unique login name (long names are truncated to eight characters)
	MEMBER OF "group"	Group object that the user is assigned to
	NOT MEMBER OF "group"	Group object that the user is not assigned to
	PASSWORD_EXPIRES	Number of days before password expires
	REQUESTER_CONTEXT	Context when login started
	USER_ID	Number assigned to each user
Network	FILE_SERVER	NetWare server name
	NETWORK_ADDRESS	IPX external network number of the cabling system (8-digit hexadecimal number)
Workstation	MACHINE	Type of computer (IBM_PC, etc.)
	NETWARE_REQUESTER	Version of the NetWare Requester for OS/2 or VLM users
	OS	Type of operating system on the workstation (MSDOS, OS2, etc.)
	OS_VERSION	Operating system version on the workstation (3.30, etc.)
	P_STATION	Workstation's node number (12-digit hexadecimal)
	PLATFORM	Workstation's operating system platform: DOS, OS2, WIN (Windows 3.1), WNT (Windows NT*), or W95 (Windows 95*)
	SHELL_TYPE	Version of the workstation's DOS shell (1.02, etc.); supports NetWare 2 and 3 shells and NetWare 4 Requester for DOS.
	SMACHINE	Short machine name (IBM, etc.)
	STATION	Workstation's connection number

Table 3-6 *continued*

**Login Script Identifier Variables**

Category	Identifier Variable	Function
DOS environment	<i>&lt;variable&gt;</i>	<p>Any DOS environment variable can be used in angle brackets (&lt;path&gt;, etc.). To use a DOS environment variable in MAP, COMSPEC, and FIRE PHASERS commands add a percent sign (%) in front of the variable. For example,</p> <pre>MAP S16:=%&lt;path&gt;</pre>
Miscellaneous	ACCESS_SERVER	Shows whether the access server is functional (TRUE=functional, FALSE=not functional)
	ERROR_LEVEL	An error number (0=no errors)
	%n	Replaced by parameters the user enters at the command line with the LOGIN utility. For more information, see Table 3-6 on page 235.
Object properties	<i>property name</i>	<p>You can use property values of NDS objects as variables. Use the property values just as you do any other identifier variable. If the property value includes a space, enclose the name in quotation marks.</p> <p>To use a property name with a space, within a WRITE statement, you must place it at the end of the quoted string:</p> <pre>WRITE "Given name=%GIVEN_NAME" IF "%MESSAGE SERVER"="MS1" THEN MAP INS S16:=MS1\SYS:EMAIL</pre> <p>To see a list of object properties, see Appendix A, "NDS Object Classes and Properties," of <i>Guide to NetWare 4 Networks</i>. Not all properties are supported.</p>

## Using Identifier Variables

When using identifier variables in login script commands, observe the following conventions.

- ◆ Identifier variables are used most often with commands such as IF...THEN, MAP, and WRITE. They can also be used with commands for which you can specify a path, such as COMSPEC.
- ◆ Type the variable exactly as shown.
- ◆ To use DOS environment variables as identifiers, enclose them in angle brackets.
- ◆ Identifier variables can be placed within literal text strings in a WRITE statement. However, the identifier variable must be in uppercase letters and preceded by a percent sign. (Literal text is the text that is displayed on the screen, such as "Sales report is due today." Literal text must be enclosed in quotation marks.)

### Examples:

- ◆ If user Smith logs in during the morning, both of the following lines display the same message on his screen ("Good morning, SMITH"):

```
WRITE "Good "; GREETING_TIME; ", "; LAST_NAME  
WRITE "Good %GREETING_TIME, %LAST_NAME"
```

- ◆ To use DOS environment variables as identifiers, enclose them in angle brackets. The following example uses the DOS environment variable "path:"

```
WRITE "my path is "%<path>
```

The text displayed on the screen is similar to

```
my path is z:.;y:.;c:\WINDOWS
```

## Using LOGIN Parameters with %n Variables

Some variables in a login script can be indicated by a percent sign (%) followed by a number from 0 to 9.

When a user logs in, he or she can type additional parameters that the LOGIN utility passes to the login script. The login script then substitutes these parameters for any %n variables in the login script. These variables are replaced in order by the parameters the user typed when executing the LOGIN utility.

The %0 variable is replaced by the name of the NetWare server the user typed at the command line, and %1 is replaced by the user's login name. The remaining variables change, depending on what the user types when executing LOGIN. The %n variables must precede all command line options.

The SHIFT login script command allows you to change the order in which these %n variables are substituted. For more information about the SHIFT command, see "SHIFT" on page 228.

The %n variables can be used in WRITE statements if included within the quotes:

```
WRITE "My login name is %1."
```

### Example

Suppose a login script contains the following commands:

```
IF "%2"="SALES" THEN
    WRITE "Meeting today"
END
IF "%3"="LEGAL" THEN
    WRITE "Report is due tomorrow"
END
```

If user RON logged in by typing the following command:

```
LOGIN COUNT\RON SALES MARKETING
```

then the login script would substitute the values Ron entered at the keyboard for the %n variables in the login script, as shown here:

```
%0=COUNT
```

```
%1=RON
```

```
%2=SALES
```

```
%3=MARKETING
```

Since %2 is replaced by “SALES,” the message “Meeting today” is displayed on Ron’s screen. However, since %3 is replaced by “Marketing,” Ron doesn’t see “Report is due tomorrow.”

## Examples of Login Scripts

The following examples of login scripts may help you plan your own container, profile, and user login scripts. Each example login script is shown in a table.

The left column of each table shows the commands in the login script. The right column explains the command’s purpose.

For instructions on creating login scripts, see “Creating or Modifying a Login Script Using NetWare Administrator” on page 177 or “Creating or Modifying a Login Script Using NETADMIN” on page 179.

### Default Login Script

The default login script executes the first time User object ADMIN logs in. It also executes for any users who do not have user login scripts.

You can’t modify the default login script because it is coded into the LOGIN utility. Instead, you can create container, profile, or user login scripts.

The following table lists the content of the default login script.

**Table 3-7**  
**Default Login Script**

Login Script Command	Purpose
MAP DISPLAY OFF	Prevents map commands from displaying on the screen.
MAP ERRORS OFF	Prevents mapping errors from displaying on the screen.
MAP *1:=SYS:	Maps the first drive to volume SYS:.
MAP *1:=SYS:%LOGIN_NAME	Maps the first drive to the user's home directory, if LOGIN_NAME is the same as the user's home directory. If the user has no home directory, the first drive is still mapped to SYS:.
IF "%1"="ADMIN" THEN MAP *1:=SYS:SYSTEM	If the login name is ADMIN, the first drive is mapped to SYS:SYSTEM instead of to the user's home directory.
MAP P:=SYS:PUBLIC	<p>If the user logs in from an OS/2 workstation, drive P: is mapped to SYS:PUBLIC.</p> <p>This mapping is used by OS/2 workstations, as explained in <i>NetWare Client for OS/2 User Guide</i>.</p> <p>If the user is not using an OS/2 workstation, this drive mapping is not included in the default login script.</p>
MAP INS S1:=SYS:PUBLIC MAP INS S2:=SYS:PUBLIC%\%MACHINE%\%OS\ %OS_VERSION	<p>If the user is using a DOS or MS Windows workstation, the first search drive is mapped to SYS:PUBLIC, where DOS-based NetWare utilities are stored.</p> <p>Then the second search drive is mapped to the directory where DOS is stored. (The two MAP commands are joined by a semicolon.)</p> <p>If the user logs in from an OS/2 workstation, these drive mappings are not included in the default login script.</p>
MAP DISPLAY ON	Allows MAP commands to display.

**Table 3-7** *continued*  
**Default Login Script**

Login Script Command	Purpose
MAP	Displays a list of all drive mappings on the user's screen.

## Container Login Script

The container login script should contain as much information as possible that applies to all users. An example is shown in the following table.

**Table 3-8**  
**Sample Container Login Script**

Login script command	Purpose
MAP DISPLAY OFF	Prevents MAP commands from displaying on the screen as they are assigned.
MAP ERRORS OFF	Prevents mapping errors from displaying on the screen.
MAP *1:=SYS:	Maps the first drive to volume SYS:.
MAP *1:=SYS:%LOGIN_NAME	Maps the first drive to the user's home directory, if LOGIN_NAME is the same as the user's home directory. If the user has no home directory, the first drive is still mapped to SYS:.
IF "%1"="ADMIN" THEN MAP *1:=SYS:SYSTEM	If the login name is ADMIN, the first drive is mapped to SYS:SYSTEM instead of to the user's home directory.



Table 3-8 *continued*

**Sample Container Login Script**

Login script command	Purpose
<pre>IF OS="OS2" THEN MAP P:=SYS:PUBLIC ELSE MAP INS S1:=SYS:PUBLIC MAP INS S2:=SYS:PUBLIC\%MACHINE%\OS\ %OS_VERSION END</pre>	<p>If the user logs in from an OS/2 workstation, drive P: is mapped to SYS:PUBLIC.</p> <p>This mapping is used by OS/2 workstations, as explained in <i>NetWare Client for OS/2 User Guide</i>.</p> <p>If the user is not using an OS/2 workstation, the first search drive is mapped to SYS:PUBLIC, where DOS-based NetWare utilities are stored. The second search drive is mapped to the directory where DOS is stored.</p> <p>If all workstations use DOS, you can use the following two commands instead of the IF...THEN command:</p> <pre>MAP INS S1:=SYS:PUBLIC MAP INS S2:=SYS:PUBLIC\ %MACHINE%\OS%\OS_VERSION</pre>
<pre>IF MEMBER OF "WIN31" THEN MAP INS *2:=SYS:USERS\%LOGIN_NAME\WIN31 MAP INS S16:=SYS:APPS\WINAPPS\WIN31 SET TEMP="P:\USERS\%LOGIN_NAME\ WIN31\TEMP" END</pre>	<p>If the user who logs in is a member of the Group object WIN31, the next available drive is mapped to that user's MS Windows directory. Then the next available search drive is mapped to the MS Windows directory for the WIN31 group. Finally, the MS Windows TEMP directory is set to a subdirectory of the user's MS Windows directory.</p>
<pre>MAP INS S16:=VOL1:APPL\WP</pre>	<p>Maps the next available search drive to the directory that contains WordPerfect.</p>
<pre>MAP INS S16:=VOL1:APPL\LOTUS</pre>	<p>Maps the next available search drive to the directory that contains Lotus.</p>
<pre>MAP INS S16:=SYS:EMAIL</pre>	<p>Maps the next available search drive to the EMAIL directory.</p>

Table 3-8 *continued*

### Sample Container Login Script

Login script command	Purpose
MAP O:=SYS:DOC	Maps drive O: to a directory necessary for running the electronic NetWare documentation (Novell DynaText*).
IF MEMBER OF "MANAGERS" THEN MAP *3:=VOL1:PROJECTS\REPORTS END	If the user belongs to the Group object MANAGERS, the login script maps the third network drive to the REPORTS directory.
IF MEMBER OF "TESTERS" THEN MAP *4:=INPUT:STATUS\UPDATES END	If the user belongs to the Group object TESTERS, the login script maps the fourth network drive to the UPDATES directory.
COMSPEC=S2:COMMAND.COM	Sets COMSPEC to the DOS command processor, located in the DOS directory (in the second search drive).
SET PROMPT="\$P\$G"	Sets the prompt to display the user's current directory path, followed by the ">" symbol.
MAP DISPLAY ON	Allows MAP commands to display.
MAP	Displays a list of all drive mappings.
WRITE	Displays a blank line between the list of mappings and following lines.
WRITE "Good %GREETING_TIME, %LAST_NAME."	Displays a greeting to the user. Example: "Good morning, SMITH."
WRITE "Your password expires in %PASSWORD_EXPIRES days."	Displays a message indicating the number of days before the user's password expires.
FIRE 3	Makes the phaser sound occur three times to tell the user that the login process is complete.

## Profile Login Script

If you have groups of users with identical login script needs, you can create a Profile object, then create a login script for it. Then you can assign each user to be a member of that Profile object.

The following table shows an example of a profile login script you might create for users in the Profile object ACCOUNTING. This profile login script would execute after the container login script had executed.

**Table 3-9**  
**Sample Profile Login Script**

Login script command	Purpose
MAP DISPLAY OFF	Prevents MAP commands from displaying on the screen as they are assigned.
MAP ERRORS OFF	Prevents mapping errors from displaying on the screen.
MAP INS S16:=VOL1:APPL\DB	Maps the first available search drive (after those assigned in the container login script) to the directory that contains the database program.
MAP *5:=VOL1:ACCOUNTS\NEW	Maps the fifth network drive (after those assigned in the container login script) to the NEW subdirectory.
MAP *6:=VOL1:ACCOUNTS\RECORDS	Maps the sixth network drive (after those assigned in the container login script) to the RECORDS subdirectory.
#WSUPDATE S1:IPXODI.COM /LOCAL	Executes WSUPDATE, which updates the IPXODI.COM file on the user's workstation with a new version of the file located in the first search drive.
MAP DISPLAY ON	Allows MAP commands to display.
MAP	Displays a list of all drive mappings.
WRITE	Displays a blank line between the list of mappings and following lines.

Table 3-9 *continued*

### Sample Profile Login Script

Login script command	Purpose
IF DAY_OF_WEEK="FRIDAY" THEN WRITE "Weekly progress report is due today" FIRE 2 END	On Fridays, the phaser sound occurs twice to alert the user while the message "Weekly progress report is due today" displays on the screen.
PCCOMPATIBLE EXIT "NMENU WORK"	Stops the profile login script and sends the user into a menu program called WORK.  EXIT also prevents any user login scripts from executing.  If you want a user login script to execute after the profile login script, put these lines at the end of the user login script instead.  (DOS workstations with the machine name IBM_PC do not need the PCCOMPATIBLE line.)  The EXIT command does not work on OS/2 workstations.

### User Login Script

The following table shows an example of a user login script for user Mary. The user login script executes after the container and profile login scripts have executed.

**Table 3-10**  
**Sample User Login Script**

Login script command	Purpose
MAP DISPLAY OFF	Prevents MAP commands from displaying on the screen as they are assigned.
MAP ERRORS OFF	Prevents mapping errors from displaying on the screen.
MAP *7:=VOL1:MARY\PROJECTS\RESEARCH	Maps Mary's seventh network drive (after those assigned in the container and profile login scripts) to the RESEARCH subdirectory in her home directory.
MAP *8:=VOL1:FORMS	Maps Mary's eighth network drive (after those assigned in the container and profile login scripts) to the FORMS directory.
REM Mary needs access to FORMS while she's on the REM troubleshooting team. Remove this drive mapping REM when she's reassigned.	<p>This remark is intended as a reminder to the person who created the login script.</p> <p>This remark isn't displayed on the user's screen. (Because the remark is several lines long, each line starts with REM.)</p>
SET WP="/u-mjr/b-5"	Sets Mary's environment variables for her word processing application.
SET USR="mrichard"	Sets Mary's username (mrichard) for the electronic mail program.
#CAPTURE Q=FAST_Q NB TI=10 NFF	Executes the CAPTURE utility so Mary can print from nonnetwork applications.
PCCOMPATIBLE EXIT "NMENU TRAINING"	<p>Stops the user login script and sends the user into a menu program called TRAINING. (DOS stations with the machine name IBM_PC don't need the PCCOMPATIBLE line.)</p> <p>EXIT doesn't work on OS/2 workstations.</p>



# 4 **Maintaining NetWare 4 Networks**

This chapter briefly describes the maintenance utilities and procedures used for managing your implementation of the Novell® Directory Services™ (NDS™) technology on your network.

The following topics are discussed in this chapter:

- ◆ “Identifying Network Monitoring and Maintenance Tools” on page 251
- ◆ “Monitoring and Maintaining Network Communication” on page 254
- ◆ “Monitoring and Maintaining Replica Synchronization” on page 256
- ◆ “Monitoring and Maintaining Time Synchronization” on page 262
- ◆ “Monitoring and Maintaining Network Hardware” on page 278
- ◆ “Monitoring and Maintaining Network Data” on page 289
- ◆ “Maintaining and Monitoring Backward Compatibility” on page 290

# Introduction

A good Novell Directory tree design provides more efficient utilization and administration of your network resources. The robust nature of Novell Directory Services (NDS) allows administrative benefits from almost any tree structure.

As you gain experience, you may find ways to better design your NetWare 4™ network to suit your needs.

It is also common that changes in your organization such as mergers, reorganizations, or changing priorities will alter the original needs for which you created the Directory tree design.

The dynamic nature of your network environment requires you to be able maintain your NetWare 4 network during routine operation, changes, and problems. The information included in this chapter will provide you with procedures for ensuring the health and maintenance of your network environment.

## Ensuring Software and Utilities Are Current

To ensure network integrity and stability, it is recommended that you stay current with patches and updates to NetWare programs and utilities. You should also read the release notes and readme files for each particular product you are installing or using.

The latest file updates and patches can be found on NSEPro™, the NetWire<sup>SM</sup> forum on CompuServe\*, and the Internet. For more information, see Appendix D, “Supplemental Information,” in *Guide to NetWare 4 Networks*.

## Testing Software and Hardware in a Lab Environment

Whenever you upgrade or install new software or hardware, you should avoid experimenting on your organization's working trees and servers.

You should set up a lab to install, configure, and test all new patches and upgrades for your particular network environment. It will provide the hands-on experience important to monitoring and maintaining an efficient network.



The hardware and software used in the lab should be representative of the existing network environment. Try to use similar network boards, LAN topology, and workstation operating systems. At least one CD-ROM player should be included for installing the NetWare 4 software on a server.

The lab environment should not affect the current operation of the existing network, but should maintain a connection to the current network backbone. This will allow for migration and backward-compatibility testing.

## Identifying Network Monitoring and Maintenance Tools

Maintaining NetWare 4 on your network requires you to monitor Novell Directory Services operations and to recognize potential or beginning problems.

NetWare 4 includes maintenance utilities to help repair and maintain your network environment. These utilities are:

- ◆ NetWare Administrator or NETADMIN
- ◆ NDS Manager or PARTMGR
- ◆ DSREPAIR
- ◆ DSTRACE (Directory Services console screen)

The best source for utility specific information for these utilities is in the utility online help. Choose the Help option or press <F1> to access the online help in each utility. See the following table for a listing of documentation sources for the network management tools.

Utility	Source documentation
NetWare Administrator	"Setting Up Administration Utilities" on page 5 Online help
NETADMIN	"Setting Up Administration Utilities" on page 5 Online help

Utility	Source documentation
NDS Manager	“Setting Up NDS Manager” on page 297 Online help
PARTMGR	“About Partitions and Replicas” on page 296 Online help
DSREPAIR	“Repairing the Novell Directory Database” on page 324 Online help
DSTRACE	“Viewing and Managing NDS Synchronization Status” on page 348

If you receive a warning when performing an operation using any of these utilities, pay particular attention to the information that is provided.

Many of the operations you can perform with these utilities can adversely change the operating environment for your users.

In particular, the DSREPAIR “Advanced Options” menu is for advanced troubleshooting purposes and should only be used in very specific situations.

NDS Manager or PARTMGR should be used for all partition operations, such as deleting a replica from a server and changing a read/write replica to a master. If a utility such as NDS Manager or NetWare Administrator returns an error during an operation, we recommend that you resolve the error instead of forcing the operation through the DSREPAIR utility.

## Viewing and Editing the Repair Log File

The DSREPAIR utility can alert you that your Directory tree has a synchronization problem.

Error conditions that come and go don't indicate a problem. However, when a persistent error exists in the DSREPAIR.LOG file, resolve the problem before modifying the Directory database. Also, in the DSREPAIR.LOG file, ensure that every server's status is "OK."

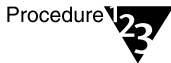
The default log file is DSREPAIR.LOG in the SYS:SYSTEM directory. You can change the filename with the "Log File and Login Configuration" option in the "Advanced Options" menu.

### Prerequisites



- Access to the server console or an established RCONSOLE session with the server
- The Supervisor object right to Directory objects in the local tree

### Procedure



1. **At the server console prompt, load the module by typing**

```
LOAD DSREPAIR <Enter>
```

If you have placed DSREPAIR in a directory other than SYS:SYSTEM, you must enter the full path to the utility.

The utility locks the Directory database.

2. **From the "Main Menu" choose the "Advanced Options" option.**
3. **Choose the "Log File and Login Configuration" option to view and configure the DSREPAIR.LOG file.**

The error log is displayed within a full text editor. You can annotate or modify the DSREPAIR log if you want to.

# Monitoring and Maintaining Network Communication

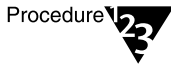
Your network's topology and communications links will impact the operation and efficiency of your Directory tree. Therefore, it is important to ensure that servers, routers, and bridges are on and functioning properly.

## Monitoring Communication Links

You can monitor the status of communication links by checking for -625 error codes in the DSREPAIR log file, NDS Manager, or the Directory Services console screen (DSTRACE screen). To view the DSREPAIR log file, see "Viewing and Editing the Repair Log File" on page 253. To use NDS Manager, see "Setting Up NDS Manager" on page 297. To use the Directory Services console screen, use the following procedure.

### Procedure

To load the Directory Services console screen, to identify whether -625 errors exist using DSTRACE,



- 1. At the server console, type**

```
SET NDS TRACE TO SCREEN = ON <Enter>
```

or

```
DSTRACE = ON <Enter>
```

- 2. Mark the status of all Server objects in the local database as "UP" by typing the following command at the server console:**

```
SET NDS SERVERS STATUS = UP
```

You can also use "Schedule Immediate Synchronization" under "Replica and Partition Operations" within DSREPAIR's "Advanced Options" menu.

Novell Directory Services will attempt to contact all servers that require information from that server. If a -625 error occurs, a communication-related problem exists.

## Resolving Communication Failures

Communication failures are generally caused by a LAN or WAN link failure.

If a communication error occurs, the DSREPAIR log file, NDS Manager, or Directory Services server console screen (DSTRACE screen) will list a -625 error. Resolving communication errors quickly will help avoid other errors due to the server's inability to synchronize.

To perform a partition or replica operation before you eliminate the -625 errors, first remove the server that is not communicating. (See "Bringing an NDS Server or WAN Link Down" on page 278.)

Therefore, if you make partition changes while a server that holds a replica involved in the change is not communicating, Novell Directory Services performance is impeded.

There are many causes for LAN or WAN link communication failures. The server reports the failures that it can detect as -625 errors.

The most common causes are as follows:

1. The communication link is completely down.

You should be able to isolate this problem easily, because none of the resources on the other side of the link will be available.

2. The link is unstable.

An unstable link can still provide consistent performance for SPX™ functions, but it cannot support NDS synchronization.

This is a difficult condition to isolate, because all SPX functions generally work well but Novell Directory Services still returns -625 errors when it tries to access a server on the other side of the link.

3. The router's RAM buffering is not large enough to provide a consistent flow of packets.

If you are experiencing dropped packets, investigate increasing the amount of RAM buffering on all routers in your network.

Different routers have different methods for monitoring dropped packets. Some routers allow you to check statistics using SNMP services; other routers can connect to a terminal.

For more information, see the router manufacturer's documentation.

4. The router is performing SAP filtering.

The two SAP numbers that cannot be filtered are 26Bx (time synchronization) and 278x (Novell Directory Services).

For more about SAP filtering on your router, see the router manufacturer's documentation.

5. One of the servers has a faulty network board.

If bad or dropped packets are being reported, make sure that the network boards in your NetWare 4 servers are functioning.

For more about diagnosing network board failures, see the network board manufacturer's documentation.

## Monitoring and Maintaining Replica Synchronization

NetWare versions prior to NetWare 4 provided views of single network resources (such as a servers) when managing network resources. NetWare 4 provides a view of the entire network of resources from a single location.

Because of the change from a server-based to a network-based system, all servers can be affected by the status of other servers.

As a result, taking down a NetWare 4 server (except for routine maintenance) might limit another server's access to network resources.

Therefore, if you have NetWare 4 servers that have replicas of a Directory partition on them or that provide time to other network servers, always leave them on.

## Determining Replica Synchronization Status

Use the following procedure on NDS servers to determine the synchronization status of replicas in the replica table for a Directory tree.

### Using DSREPAIR

The status informs you of the current condition of the Directory tree.

#### Prerequisites



- Access to the server console or an established RCONSOLE session with the server
- The Supervisor object right to the [Root] object of the Directory tree

#### Procedure



1. **At the server console prompt, load DSREPAIR by typing**

```
LOAD DSREPAIR <Enter>
```

If you have placed DSREPAIR in a directory other than SYS:SYSTEM, specify the full path to DSREPAIR.

Once DSREPAIR is loaded, the Novell Directory database is locked so that information can't be accessed or updated until the operation is completed.

2. **Choose "Replica Synchronization."**

The "Log In as the Admin" screen appears.

3. **Enter the administrator name and password to log in to the tree, and press <Enter>.**

Log in as a user who has the Supervisor object right to the [Root] object of the tree. Enter your complete name (Distinguished Name), such as ADMIN.ACME or CN=ADMIN.O=ACME. Entering only ADMIN is invalid because it is not a complete name.

After pressing <Enter>, The “Collecting Replica Synchronization and Server Status” screen appears. (A window is available to observe the operations in process.)

Following this operation, the DSREPAIR log is displayed within a full text editor. You can annotate or modify the DSREPAIR log.

The error log contains the following fields:

Field	Indicates
Servers that Contain Replicas	The servers in the tree that contain replicas.
Replica Type	The type of replica for each server that contains replicas of partitions.
Status	The synchronization status of partition replicas for servers in the tree. The server running DSREPAIR does not synchronize to itself, so the status for the server's own replica is displayed as “Host.”

Before you perform a partition operation, check the synchronization states of all servers that contain copies of the affected partitions. Refer to the following table to determine which partitions are affected.

Partition Operation	Partitions Affected
Create, add, or delete partitions	Target
Change replica types	Target
Rebuild replicas	Target
Merge partitions	Parent and child

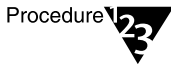


## Using DSTRACE



### Prerequisites

- Access to the server console, or an established RCONSOLE session with the server.



### Procedure

1. **Turn on the Directory Services (DSTRACE) console screen by typing the following at the server console:**

```
SET NDS TRACE TO SCREEN = ON <Enter>
```

or

```
DSTRACE = ON <Enter>
```

2. **(Optional) To copy NDS Trace messages to a file, type**

```
SET NDS TRACE to FILE = ON <Enter>
```

or

```
SET TTF = ON <Enter>
```

By default, the messages are copied to the DSTRACE.DBG file in the SYS:SYSTEM directory.

To copy the messages to a different directory and/or file on volume SYS:, type

```
SET NDS TRACE FILENAME = path\filename <Enter>
```

Example:

```
SET NDS TRACE FILENAME = SYS:SYSTEM\DSERROR.LOG  
<Enter>
```



Copying NDS Trace messages to a file may be helpful if you need to ask someone else for diagnostic help.

3. To view NDS Trace screen messages, press <Alt>+<Esc> until you see the “Directory Services” screen.

Two types of messages are of particular interest:

- ◆ “All processed = YES” indicates that all pending Novell Directory Services synchronization actions have been processed.
- ◆ Messages numbered –601 through –699 and F966 through F9FE indicate Novell Directory Services status or errors. For explanations and suggested actions, see *System Messages*.

4. To disable tracing, type

```
SET NDS TRACE TO SCREEN = OFF <Enter>
```

or

```
DSTRACE = OFF <Enter>
```

---

For more information about	Refer to
NDS Trace options	“Novell Directory Services Parameters” under SET in <i>Utilities Reference</i>
NDS system messages	<i>System Messages</i>

---

## Performing an Immediate Synchronization

Use the “Immediate Synchronization” option under the DSREPAIR “Advanced Options” menu to schedule an immediate synchronization. This saves waiting up to five minutes for the synchronization process to take place automatically.

You can also use the Novell Directory Services SET command “SET NDS SERVERS STATUS=UP” at the server console Directory Services screen to clear transport failure communication errors. Novell Directory Services then retries communication at the next synchronization interval.

## Server Synchronization

If Novell Directory Services can't synchronize with a specific server, make sure the server is running the Novell Directory Services software. Then make sure that all hardware, routers, and bridges are functioning.

If a server was taken down or was physically removed from the network, make sure it didn't contain the master replica of a Directory partition.

If it did contain a master replica, assign a new master replica to another server.



To designate a new master replica, use the DSREPAIR "Advanced Options" Menu "Assign New Master replica" option. Then, using the "Ring Edit" option, edit the replica ring and delete any reference to the server.

Use the "Assign New Master" option only when a server containing a master replica is permanently removed from the network.

## Maintaining Replica Synchronization Status When a Server Is Down

If you must bring down a server for an extended period, remove partition replicas before downing the server. (Use NDS Manager or PARTMGR.)

If you don't remove replicas before bringing down a server for an extended period, partition operations (such as split and join) can't function on other servers, because all replicas must be available.

Novell Directory Services also tries to synchronize new partition information with replicas stored on servers throughout the Directory tree.

If a replica is stored on a downed server, Novell Directory Services will keep trying to synchronize with the server until it succeeds.

When a server is reactivated, it synchronizes the replicas it contains. Still, some Novell Directory Services operations aren't possible or are delayed if the server can't be contacted by other servers in the Directory tree.

# Monitoring and Maintaining Time Synchronization

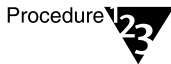
Time synchronization is very important to Novell Directory Services. All servers in a tree must be synchronized to the same time source. If they are not, collision will occur when objects are being synchronized in replicas.

## Determining Time Synchronization Status



### Prerequisites

- Access to the server console or an established RCONSOLE session with the server
- All servers in a tree using the same time source



### Procedure

1. **At the server console prompt, load the module by typing**

```
LOAD DSREPAIR <Enter>
```

If you have placed DSREPAIR in a directory other than SYS:SYSTEM, you must enter the full path to the utility.

Once DSREPAIR is loaded, the Novell Directory database is locked so that information can't be accessed or updated until the operation is completed.

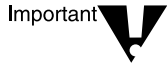
2. **Choose "Time Synchronization."**

The "Collecting Time Synchronization and Server Status" screen appears. A window is available to observe the operations in process.

Following the operation, the DSREPAIR log is displayed within a full text editor. You can annotate or modify the DSREPAIR log if you want to.

The DSREPAIR log contains the following:

Field	Indicates
Server Name	All of the server names known to the local copy of the Directory database files. If this server contains a replica of the [Root] partition, then this list contains all the servers in the tree.
Version	The version of DS.NLM running on the server.
Replica Depth	The replica depth field reports “-1” if no replicas are stored on the server or “0” if the server contains a replica of the [Root] partition. A positive integer indicates how many objects deep from the [Root] the first replica is on that server.
Time Source	<p>The time server type. This information helps you determine if time synchronization for all the trees in the server is configured properly.</p> <p>All servers in a tree must be using the same time source.</p> <p>For example, if there are two Single time servers, then you know that all servers in the tree cannot be polling the same time source and that there is a configuration problem.</p>
Time in Sync	The local time synchronization status on each server. This status should be “Yes.” If the status is “No,” then the server is not able to contact its time source.
Time +/-	<p>The difference in time between the local server and the selected server in the list. All servers should be within one second of each other; if they are not, they have not been configured properly.</p> <p>This field reports up to 999 minutes and 59 seconds (which is approximately 16 hours and 30 minutes) in the form <i>minutes:seconds</i>. If the time difference is greater than 16 hours and 30 minutes, then the maximum value is displayed as: -999:59.</p> <p>If the difference in time is more than a few minutes, it might indicate that the servers are using different time source servers.</p>



Use the DSREPAIR “Time Synchronization” option before or after performing a repair. This option allows you to contact all servers within this server’s local database to request information about Novell Directory Services (NDS) and time synchronization. If a replica of the [Root] partition is contained on this server, then all servers in the Directory tree are contacted.

## Ensuring that the Server’s DOS Clock Is Accurate

To ensure that the correct date and time is used when running patches that update SERVER.EXE, make sure that the DOS clock is set correctly.

If the time and date are incorrect, version control problems might arise.

Bring down the server and set the correct date and time in DOS. Booting the server sets the DOS clock to match the CMOS clock on the server.

## Setting Time in NetWare 4

To change the time on NetWare 4.11 servers, use the TIME command at the server console.

Then use the TIMESYNC command to verify that time synchronization is correct. When using the TIME command, you should receive the following message:

```
TIME IS SYNCHRONIZED
```

If you receive the following message, determine why the time is not synchronized and resolve the problem:

```
TIME IS NOT SYNCHRONIZED
```

Time synchronization errors occur when

- ◆ A server has received an error while communicating with another time server.
- ◆ The TIMESYNC configuration file tells TIMESYNC to communicate with a nonexistent server.
- ◆ The clock time on a server is out of synchronization with the network time. In this case, TIMESYNC will eventually synchronize the times.

To verify which of these conditions exists use the following procedure.

1. Type `TIME` at the console, and check the response to see if the time is correct.

If the time is only minutes out of synchronization, `TIMESYNC` will soon synchronize the time. However, if the time difference is hours or days, go to Step 2.

2. If the time difference between servers is too great for automatic synchronization, then bring down the server using the `DOWN` command and exit to DOS. Then use the `DOS TIME` command to correct the DOS clock.

Cold boot the server and make sure that the hardware clock is maintaining the correct time.



Do not correct the server's time at the server console or while NetWare is running.

Restart the NetWare 4 operating system. At the server console, type `SET TIMESYNC DEBUG = 7`. `TIMESYNC` then displays its messages on the server console.

If the server is a Secondary time server, the messages will show it contacting a Primary server and calculating the time offset.

If the server is a Primary or a Reference server, the message shows the name of the server it is contacting, along with a polling weight.

The polling weight should be 1 for other contacted Primary servers and 16 for Reference servers. A polling weight of 0 indicates a communication failure.

Check to see that the other contacted server is communicating. If it is, make sure that the routers are not restricting the `TIMESYNC` SAP.

If the server is a Primary or Reference server, it must vote successfully with at least one other Primary server.

Otherwise, if no vote is observed, the server is probably a Single Reference server.

Use the `TIMESYNC TYPE` command at the server console to determine which type of time server it is.

Other causes of time synchronization errors are:

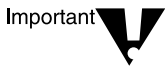
- ◆ The time zone is not set correctly.
- ◆ The daylight saving time parameter is not set.
- ◆ The previous version of AUTOEXEC.NCF file has accidentally overwritten the NetWare 4 AUTOEXEC.NCF file during upgrade.

## Maintaining Network Time Synchronization

Time synchronization ensures that all servers in a Directory tree report the same time and order Novell Directory Services events correctly.

NetWare 4 uses the TIMESYNC NLM, which automatically loads when the server is booted, to control time synchronization. The TIMESYNC.CFG file in SYS:SYSTEM can contain parameters for the TIMESYNC NLM, if the default settings are not adequate.

To change the time synchronization configuration on a NetWare server, use the EDIT server utility to modify the parameters in the TIMESYNC.CFG file, and then reboot the server.



Do not put SET time synchronization parameters in the STARTUP.NCF file, because the TIMESYNC.CFG file is read *after* the STARTUP.NCF file.

### SET Parameters for TIMESYNC

Table 4-1 shows the SET parameters used to configure time synchronization. The defaults are appropriate for most small networks. For large network TIMESYNC considerations, see “Configuring Time Synchronization for Large Networks” on page 273.

Table 4-1  
Time Synchronization SET Parameters

SET parameter and default	Recommended usage
TIMESYNC ADD Time Source Default: None	Instead of using this parameter, use EDIT to add a time server to the time source list in the TIMESYNC.CFG file.
TIMESYNC Configuration File Default: SYS:SYSTEM	Use this parameter to specify the file path if the TIMESYNC.CFG file is <i>not</i> located in SYS:SYSTEM.



Table 4-1 *continued*

**Time Synchronization SET Parameters**

SET parameter and default	Recommended usage
TIMESYNC Configured Sources Default: OFF	Set this parameter ON if you are using a custom-configured list of time sources.
TIMESYNC Directory Tree Mode Default: ON	Setting this parameter OFF allows SAP packets from other Directory trees to influence time synchronization on this server's Directory tree.
TIMESYNC Hardware Clock Default: ON	Set this parameter OFF <i>only</i> if this server uses an external time source (such as a radio clock). All servers in the same tree should have the same setting for this parameter.
TIMESYNC Polling Count Default: 3 (time packets)	Do not increase this setting. Doing so adds unnecessary traffic to the network.
TIMESYNC Polling Interval Default: 600 (seconds)	Decrease this setting if you need to poll time servers more often than every 10 minutes. All servers in the same tree should have the same setting for this parameter.
TIMESYNC REMOVE Time Source Default: None	Instead of using this parameter, use EDIT to remove a time server to the time source list in the TIMESYNC.CFG file.
TIMESYNC RESET Default: OFF	Instead of using this parameter, use EDIT to reset values in the TIMESYNC.CFG file and to remove the list of time sources.
TIMESYNC Restart Flag Default: OFF	Set this parameter ON <i>only</i> if you want to reload the TIMESYNC NLM (because you edited TIMESYNC.CFG) without rebooting the server.
TIMESYNC Service Advertising Default: ON	Set this parameter OFF if you are using a custom-configured list of time sources.
TIMESYNC Synchronization Radius Default: 2000 (milliseconds)	Increase this parameter to allow a wider margin of error for time synchronization between servers. If you decrease the radius too much (below 1,000), some time servers may never achieve synchronization.
TIMESYNC Time Adjustment Default: None	Use this parameter sparingly to correct network-wide time errors, or you may corrupt time synchronization and the order of events on your network.

Table 4-1 *continued*

### Time Synchronization SET Parameters

SET parameter and default	Recommended usage
TIMESYNC Time Source Default: None	Instead of using this parameter, use EDIT to add a time server to time source list in the TIMESYNC.CFG file or display the time source list.
TIMESYNC Type Default: Secondary	Instead of using this parameter, use EDIT to change the default time server type in the TIMESYNC.CFG file.
TIMESYNC Write Parameters Default: OFF	Instead of using this parameter, use EDIT to change the settings in the TIMESYNC.CFG file.
TIMESYNC Write Value Default: None	Instead of using this parameter, use EDIT to modify the TIMESYNC.CFG file.

### Editing the TIMESYNC.CFG File

Time synchronization parameters are stored in their own configuration file, by default the TIMESYNC.CFG file in the SYS:SYSTEM directory.

To change the time synchronization configuration on a NetWare server, modify the parameters in the TIMESYNC.CFG file, and then reboot the server or use SET to turn ON the “TIMESYNC Restart Flag” parameter.



Note

You can use SET or SERVMAN to change the TIMESYNC parameters; however, unless you also edit the TIMESYNC.CFG file, changes made in SET or SERVMAN will be lost the next time the server boots.

### Prerequisites



Checklist

- Access to the server console, or an established RCONSOLE session.



## Procedure

1. **At the server console prompt, type**

```
LOAD EDIT <Enter>
```

You are prompted to enter the file to edit.

2. **At the prompt, type**

```
SYS:SYSTEM\TIMESYNC.CFG <Enter>
```

The current TIMESYNC.CFG file appears.

3. **Use the arrow keys to move the cursor to the lines you need to edit.**
4. **Modify the settings for the TIMESYNC parameters you want to change.**
5. **To save your edits, press <Esc>.**  
A confirmation prompt appears.
6. **To save the TIMESYNC.CFG file, choose “Yes.”**
7. **To exit EDIT, press <Esc>.**



If you have several parameters in your TIMESYNC.CFG file, you may want to copy the file from server to server. Be sure that each copied TIMESYNC.CFG file contains the correct default time server type and configured-sources list for the server it configures.

## Creating a Custom Time Source Configuration

Time servers use one of two methods to find each other on the internetwork: SAP (Service Advertising Protocol) and custom time source configuration.

### SAP Method

By default, Primary, Reference, and Single Reference time servers use SAP to announce their presence on the network. Secondary time servers do not advertise, but they do “listen to” SAP information to find the nearest time source.

The SAP method allows for quick installation without regard to the network layout. It also allows automatic reconfiguration if new servers are added to the network.

### **Custom Time Source Method**

The custom time source method lists specific, authorized time servers that each server contacts to determine network time. In a custom time configuration, servers do not listen for SAP information from other time servers, and they do not advertise with SAP.

A configured-sources list resides in the TIMESYNC.CFG file of each time server on the internetwork. The order of the server names in the list is the polling order the server follows to get the correct time.

The custom configuration method requires careful planning before NetWare installation, but it gives the network supervisor complete control of the time synchronization environment.

In most circumstances, you can use the default SAP method and do not need to create a custom time source configuration. However, you may need a custom configuration if

- ◆ You have more than one Reference or more than one Primary time server on your network.
- ◆ You frequently add or remove temporary or “test” servers to or from your network.
- ◆ You need to prevent unauthorized time sources from determining network time.

Use this procedure to create a custom time source configuration. These steps must be repeated for each time server on your network.

### **Prerequisites**



- A prioritized list of time sources.



## Procedure

1. **At the server console prompt, type**

```
LOAD EDIT <Enter>
```

You are prompted to enter the file to edit.

2. **At the prompt, type**

```
SYS:SYSTEM\TIMESYNC.CFG <Enter>
```

The current TIMESYNC.CFG file appears.

3. **Add the following parameters to the TIMESYNC.CFG file:**

```
Type = x  
Service Advertising = OFF  
Configured Sources = ON
```

Replace *x* with this server's time server type (Reference, Single Reference, Primary, or Secondary).

4. **Add the list of time sources for this server as follows:**

```
Time Source = x  
Time Source = y  
Time Source = z
```

Replace *x* with the name of the first time server this server should contact (probably a Reference server or the nearest Primary time server). Replace *y* and *z* with the name of the other time servers this server should contact, in order of importance.



The order of the time servers in the time source list determines their priority when advertising network time.

5. **To save your edits, press <Esc>.**

A confirmation prompt appears.

6. **To save the TIMESYNC.CFG file, choose "Yes."**

7. **To exit EDIT, press <Esc>.**



If you have several parameters in your TIMESYNC.CFG file, you may want to copy the file from server to server. Be sure that each copied

TIMESYNC.CFG file contains the correct default time server type and time source list for the server it configures.

For more information about	See
SAP	"Service Advertising Protocol" in <i>Concepts</i>
Time server types	"Planning the Time Synchronization Strategy" in Chapter 8 of <i>Guide to NetWare 4 Networks</i>
Time synchronization	"Time synchronization" in <i>Concepts</i>

## Adjusting a Fast or Slow Reference Time Server

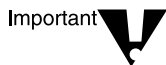
If your Reference time server is inaccurate by several minutes, all other time servers in your network will also be inaccurate.

To correct the time on the Reference server (and therefore, network-wide), type the following SET command at the Reference server's console:

```
SET TIMESYNC Time Adjustment=[+|-] hour:minute:second  
at month/day/year hour:minute:second [AM|PM] <Enter>
```

For example, if your Reference Server is 10 minutes fast and you want to adjust the time at 2:00 a.m. on May 1, 1996, you would type

```
SET TIMESYNC Time Adjustment=-00:10:00 at 5/1/96  
2:00:00 AM <Enter>
```



Adjusting network time affects the order of Novell Directory Services events. It is best to schedule time adjustments during low-usage periods, such as late evening or early morning.

To cancel a time adjustment, type the following SET command at the Reference Server's console:

```
SET TIMESYNC Time Adjustment = cancel <Enter>
```



The cancel command must be issued *before* the scheduled time adjustment and at the *same* server where the original time adjustment was set, or it will not cancel the time adjustment.

## Configuring Time Synchronization for Large Networks

Some of the default settings for TIMESYNC are not suitable for large networks. This section explains time synchronization considerations for configuring large installations.

### Time Providers and Time Consumers

Time synchronization servers are either *time providers* or *time consumers*. Secondary servers are time consumers. Single Reference, Reference, and Primary servers are time providers.

Reference and Primary servers must be able to exchange information with another time provider in order to synchronize. A Reference or Primary server cannot claim to be synchronized if it is the only time provider on the network, because it requires at least one other time provider to synchronize with.

The Single Reference server is, as its name implies, a special type of Reference server that does not need another time provider in order to synchronize.

Secondary servers (time consumers) require at least one time provider.

### Time Synchronization and the Directory Tree

Although time synchronization and Novell Directory Services are independent features of NetWare 4, time synchronization can be configured to follow the Directory tree structure.

The default NetWare 4 installation makes the [Root] server in a Directory tree a Single Reference time server and all other servers in the tree Secondary time servers.

The default time synchronization parameter, "SET TIMESYNC Directory Tree Mode = ON," recognizes the Directory tree structure and only synchronizes time within that tree.

In a large installation with more than one Directory tree, the network supervisor can change the defaults to configure time synchronization across Directory trees.

The default does not require custom time synchronization parameters during installation. However, the default relies on a Single Reference server, thus permitting only a single point of failure and increasing network traffic at that server.

In addition, the default installation relies on Service Advertising Protocol (SAP) packets to identify the time providers.

On a large network, relying on SAP is not only inefficient, but can also lead to errors, especially if it is common for test servers (which may be misconfigured) to come and go on the network.

The custom time source method described under “Custom Time Source Method” on page 270 is recommended for large networks because it does not rely on SAP.

The time synchronization algorithm always attempts to contact explicitly named time sources before listening to SAP. This makes it possible to synchronize across Directory trees, because the Directory Tree Mode only applies to SAP packets.

Network supervisors with custom-configured time sources may choose to eliminate the use of SAP entirely.

### **Using an .NCF File to Configure Multiple Time Servers**

One easy way to configure several servers is to create a custom .NCF file containing the SET parameters required to configure time sources.

Using the custom .NCF file avoids repetitive typing at each server console. Include the “SET TIMESYNC Write Parameters = ON” parameter in the custom .NCF file to save the time source parameters to each server’s TIMESYNC.CFG file.

Most servers will have identical TIMESYNC configuration parameters with the exception of the time source list, where the first entry in the list likely varies from server to server.

To change the first server in the time source list, edit the TIMESYNC.CFG file or issue the “SET TIMESYNC Time Source” parameter from the server console before saving the configuration parameters.



## Avoiding SET TIMESYNC Parameter Inconsistencies

Several of the SET TIMESYNC parameters interact with each other. Because these parameters are set on each server, it is important to configure the entire network consistently.

Understanding the relationship of the parameters described here can help avoid time synchronization problems on large networks.

### **SET TIMESYNC Service Advertising = ON/OFF**

When ON, time providers advertise using SAP. This parameter has no effect on time consumers (Secondary time servers). When OFF, time providers do not advertise.

We recommend all servers be configured the same (ON or OFF) in order for this parameter to be effective.

### **SET TIMESYNC Configured Sources = ON/OFF**

When ON, time servers do not listen to SAP information. They listen only to the time providers in the configured sources list (initially read from the TIMESYNC.CFG file). When OFF, time servers listen for SAP information.

### **SET TIMESYNC Directory Tree Mode = ON/OFF**

When ON, time providers do not advertise under the name of the host server. Instead, they advertise under the name of their Directory tree. When ON, servers listening for SAP packets will reject packets that are not from within their own tree.

When OFF, time providers advertise under their host server name, and listening servers will accept packets from any time provider.

This parameter also interacts with the “SET TIMESYNC Service Advertising” and the “SET TIMESYNC Configured Sources” parameters. “Directory Tree Mode” has no effect if “Service Advertising” is OFF and “Configured Sources” is ON.

### **SET TIMESYNC Time Source and SET TIMESYNC Add Time Source**

These parameters identify a time provider by server name. When configured sources are listed in a server’s TIMESYNC.CFG file, their time information is always used before any SAP information is considered.

### **SET Default Time Server Type**

This parameter provides a method to override the default TIMESYNC type, which is Secondary, without using a TIMESYNC.CFG file.

However, when present, the “SET TIMESYNC Type” parameter always overrides the “SET Default Time Server Type” parameter.

If you use INSTALL to change the default type, it may have no effect if you have already created a TIMESYNC.CFG file with the overriding “TIMESYNC Type” parameter in it.

## **Example of Synchronizing Two Directory Trees**

Suppose you have two Directory trees on your network and you want all the servers in both trees to synchronize to the same time.

You used the default installation, so the [Root] servers of each tree (ROOT1 and ROOT2) are Single Reference servers, “Directory Tree Mode” is ON, and “Service Advertising” is ON.

Each tree is synchronized within itself, but time between the trees differs by a few minutes. To synchronize both trees together, create a custom .NCF file containing the following commands and execute it on the respective servers:

Server ROOT1:

```
SET TIMESYNC Type = REFERENCE
SET TIMESYNC Time Source = ROOT2
SET TIMESYNC Write Value = 3
SET TIMESYNC Write Parameters = ON
```

Server ROOT2:

```
SET TIMESYNC Type = PRIMARY
SET TIMESYNC Time Source = ROOT1
SET TIMESYNC Write Value = 3
SET TIMESYNC Write Parameters = ON
```

The root servers of both trees will synchronize, which in turn will synchronize all of the other servers in both trees.

Since the roots are now both time providers, it is necessary to change the “TIMESYNC Types” from “Single” to “Reference” on Server ROOT1 and from “Single” to “Primary” on Server ROOT2.

Server ROOT1 is a Reference server so that there will be a central point for controlling time on the network.

The “Write Parameters” command causes the TIMESYNC.CFG file to be rewritten so the changes will be in place if the servers are rebooted.



When you synchronize two Directory trees, you basically double the size of the time synchronization network. You should examine the physical layout of the network and add other Primary servers, or consider hand-configuring the time sources and eliminating the use of SAP.

For more information about	See
Time server types	“Planning the Time Synchronization Strategy” in Chapter 8 of <i>Guide to NetWare 4 Networks</i>
Time synchronization	“Time synchronization” in <i>Concepts</i>
SAP	“Service Advertising Protocol” in <i>Concepts</i>

## Monitoring and Maintaining Network Hardware

NetWare versions prior to NetWare 4 provided views of single network resources (such as a servers) when managing network resources. NetWare 4 provides a view of the entire network of resources from a single location.

Because of the change from a server-based to a network-based system, all servers can be affected by the status of other servers.

As a result, taking down a NetWare 4 server (except for routine maintenance) might limit another server’s access to network resources.

Therefore, if you have NetWare 4 servers that have replicas of a Directory partition on them or that provide time to other network servers, always leave them on.

If you can’t repair the server in a few hours however, remove it from the tree until the problem is resolved.

### Bringing an NDS Server or WAN Link Down

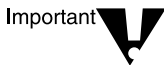
Before you take a server or WAN link down, make sure you check the server’s synchronization states. (See “Monitoring and Maintaining Replica Synchronization” on page 256.)

Use the “Planned Backup” option in the “Maintenance Mode” of INSTALL to prepare the network for downing the server, or follow the procedures documented in this section. For more information, see “Planned Backup for Hardware Upgrade” on page 283.

Use the **DOWN** command at the server console to ensure data integrity before turning off power to the server.

The following table lists required actions for each event.

Event	Action
Bringing a server or WAN link down permanently	Remove NDS from the server.
Bringing a server or WAN link down temporarily if you are replacing the hard disk that contains volume SYS:	Remove NDS from the server.
Bringing a server or WAN link down temporarily for <ul style="list-style-type: none"><li>◆ Partition operations</li><li>◆ Large numbers of changes, adds, or deletes of replicas</li><li>◆ Relocation of the server to another site</li></ul>	Remove replicas from the server before bringing down the server or disconnecting WAN links.



Make sure you back up your data properly before performing this operation. If you fail to do a backup, you might lose trustee assignments. Bindery services is lost on servers where partition replicas containing the bindery context are removed.

## Removing Novell Directory Services

Using **INSTALL** to remove Novell Directory Services from a server can corrupt your Directory database if other server depend on the server for replica or time synchronization information.

In most cases, this procedure isn't necessary to correct an NDS problem. Before removing NDS, consider the following:

- ◆ Do other servers get Directory information (such as partition replicas) from this server?
- ◆ Could a bad LAN driver (one that doesn't allow NDS to communicate properly) be causing the problem?

- ◆ Could routers, network boards, or other hardware components be causing the problem?

It is rarely necessary to remove Novell Directory Services from a server. You should remove Novell Directory Services *only* if you are sure that doing so will assist you in recovering your Directory tree.

Try correcting any problems first by removing and reinstalling replicas with the partition management utilities. Remove Novell Directory Services only as a last resort.

By removing Novell Directory Services, you remove the Server object from the Directory tree and downgrade the server's volumes to bindery volumes. Trustee assignments and all Novell Directory Services information, such as links to subordinate partitions, are removed.



If you installed the server into the wrong container, it isn't necessary to remove Novell Directory Services. Use NDS Manager to move the Server object to the correct container.

If you are going to remove Novell Directory Services from a server and want to preserve the trustee rights for objects stored on the server, perform an NDS-aware SMS backup. For more information, see "Understanding Backup for the Novell Directory Database" on page 603.

When you remove Novell Directory Services, the remove process creates a file that maps Novell Directory Services names to object ID numbers. This file is used to restore the trustee rights when you reinstall Novell Directory Services.

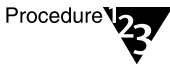
## Removing NDS Using INSTALL

Use the following procedures to remove Novell Directory Services using INSTALL.



### Prerequisites

- Access to the server console.
- A user with Supervisor object rights to the Server object and its associated Volume objects.
- Make sure all of the server's volumes are mounted. Unmounted volumes won't get their Volume objects removed from the Novell Directory database.
- Use NDS Manager or PARTMGR to identify and document the replicas contained on the server.
- Remove all replicas from the server. If a master replica exists, ensure that a replica on a different server is changed to a master replica.
- Bring down the server and cold boot it before you reinstall Novell Directory Services.



### Procedure

1. **At the server console, type**

```
LOAD INSTALL <Enter>
```

2. **From the "Installation Options" menu, select "Directory Options (Install Novell Directory Services)."**
3. **From the "Directory Services Options" menu, select "Remove Directory Services from this Server."**
4. **At the confirmation prompt, choose "Yes."**

The "Directory Services Login/Authentication" screen appears.

5. **Type the password for the network supervisor in the “Password” field and press <Enter>.**

After you enter the password, the server's mounted volumes are downgraded and a message displays the number of volumes affected. Then the system checks for Directory connections to other servers.

6. **(Conditional) If this server contains a master replica, you must designate another server to hold it. Choose one of the following:**

- ◆ Locate a server automatically.

INSTALL finds the first server with a replica of this partition and changes its type to “master.”

- ◆ Designate the server yourself.

Highlight the server where you want the master replica located.

- ◆ Press <F10> to save and continue.

A message notifies you that the master replica has moved.

7. **To continue, press <Enter>.**

INSTALL removes Novell Directory Services and deletes the Server object and Volume objects associated with it from the Directory database.

If a Directory link is down (such as another server containing objects from this server), use NDS Manager to delete the Server and Volume objects from Novell Directory Services.

8. **To exit INSTALL, press <Esc>.**



## Removing Replicas

Use NDS Manager or PARTMGR to remove replicas from a server. When you remove replicas, keep the following in mind:

- ◆ If a master replica becomes unavailable (for example, if the server will be down for an extended period of time or if the master replica becomes corrupted), change a read/write or read-only replica on another server to the master replica.

Doing so automatically changes the old master replica to a read/write replica.

- ◆ Always have at least three copies of each partition in the Directory tree, to provide fault tolerance.
- ◆ Removing partition replicas from a server might prohibit bindery services access to the server.

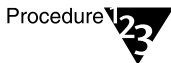
## Planned Backup for Hardware Upgrade

The following procedures allow you to back up server Novell Directory Services information from existing hardware and to restore it to new hardware. This will keep the rights, access, and user IDs intact.

### Backing up Server NDS Information Before Hardware Upgrade

The following procedure backs up the Novell Directory Services information to a file called BACKUP.NDS, which you can use to restore the server Novell Directory Services information to upgraded hardware.

#### Procedure



1. **At the server console, type**  
  
`LOAD INSTALL <Enter>`
2. **From the “Installation Options” menu, choose “Directory Options.”**
3. **From the “Directory Options” menu, choose “Directory Backup and Restore Options.”**

**4. Choose “Save Local DS Information Prior to Hardware Upgrade.”**

**5. Enter the supervisor’s name and password.**

The BACKUP.NDS file is created. You will need to access this file after you have replaced the hardware. You can save it to another server on the network, or to drive C: of the server.

**6. Remove NDS.**

For more information, see “Removing Novell Directory Services” on page 279.

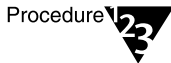
This will create a placeholder for the downed server that will hold all information from the network until the server is brought back up.

**7. Uninstall the server.**

## Restoring Server NDS Information After Hardware Upgrade

The following procedure restores the server Novell Directory Services information using the BACKUP.NDS file.

### Procedure



**1. Install new hardware.**

**2. Reinstall NetWare 4 on the server. When prompted to “Choose a Directory Tree,” press <F5>.**

This allows you to install the server-specific Novell Directory Services information from the BACKUP.NDS file, instead of installing a new server.

**3. Enter the path to the BACKUP.NDS file.**

**4. Continue with the normal installation.**

**5. Restore the file system data from an SMS backup.**

For more information, see Chapter 9, “Backing Up and Restoring Data,” on page 591.

## Resolving Hard Disk Failures

Because Novell Directory Services information is stored on volume SYS: of each NetWare 4 server in the network, resolving hard disk failures on a server requires you to identify if the failure is on volume SYS: or not.

The procedures you follow depend on if the error exists on volume SYS: or another volume.

To resolve failures with volume SYS:, see “Involving Volume SYS:” on page 286. To resolve failures on volumes other than volume SYS:, see “On Volumes Other Than SYS:” on page 285.

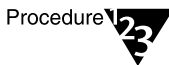
### On Volumes Other Than SYS:

If the hard disk failure does not involve volume SYS:, you do not need to modify or reinstall Novell Directory Services.

As soon as the volume is mounted again, the Volume object will function as before.

To restore a volume after a hard disk failure not involving volume SYS:, follow these steps:

#### Procedure



1. **Replace the bad hard disk.**
2. **Create a NetWare partition.**
3. **Define volumes using INSTALL.**
4. **Mount the volumes.**
5. **Restore data, file ownership, and trustees using your backup system.**

If the backup system is unable to restore file ownership and trustee information, you will have to do this manually.

The restoration of the volume is complete.

## Involving Volume SYS:

Because the Directory database is located on volume SYS:, a hard disk crash involving volume SYS: is equivalent to removing NetWare 4 from the file server.

You must reinstall NetWare 4 and Novell Directory Services before you restore your data.

### Procedure



**1. Document the replicas located on the server.**

Use NDS Manager to select the server object and record the replicas listed.

**2. If any replica displayed in Step 1 is a master replica, designate a new master replica on a different server in the tree.**

Run DSREPAIR on a server that has a current read/write replica of the partition you need to change.

**3. To change the replica type,**

**3a. Load DSREPAIR.**

**3b. Choose “Advanced Options.”**

**3c. Select “Replica and Partition Operations.”**

**3d. Select the partition you want to edit.**

**3e. Select “Designate this server as the new Master replica.”**

**3f. Exit DSREPAIR.**

**4. Using NDS Manager, delete the Server object of the server on which the hard disk crashed.**

**5. Using NetWare Administrator or NETADMIN, delete the Volume objects associated with the server.**

6. **At the server console of the server that contains copies of the partition in which the deleted server object was located, type**

`LOAD DSREPAIR <Enter>`

7. **Check replica synchronization of all partitions that existed on the deleted server and resolve all errors before proceeding.**
8. **Resolve all errors before proceeding.**
9. **If any -625 errors occur while Novell Directory Services is trying to connect to the server you deleted in NDS Manager, wait to see if the error clears up. If the error remains, remove replica pointers to the deleted server using DSREPAIR.**



Normally, you only need to perform the following steps on the master replica. Novell Directory Services should synchronize the deletion. If following these steps doesn't clear up the -625 errors, perform the same steps on all servers containing replicas of the partition in question.

Be careful when doing this operation. It can cause irreparable damage to the Directory database.

Use the procedures listed in this step only to remove a deleted server object. Using these procedures to delete an active server from a replica pointer list will corrupt the list.

Perform normal partition operations with NDS Manager or PARTMGR. Use the "Replica Synchronization" option in DSREPAIR only when the master replica of a partition is lost because of server or hardware failure. The server will be reinstalled into the Novell Directory tree.

If a server containing a read/write or read-only replica is changed to a master replica and the server containing the original master replica is brought back up, the partition might have two master replicas. Check the DSREPAIR.LOG file in DSREPAIR to identify where master replicas are stored.

To remove the deleted server out of the replica pointer list:

- 9a. **Load DSREPAIR.**
- 9b. **Choose "Advanced Options."**
- 9c. **Select "Replica and Partition Operations."**
- 9d. **Select the partition you want to edit.**
- 9e. **Select "View Replica Ring."**
- 9f. **Select the name for the deleted server.**

**9g. Select “Remove This Server from the Replica Ring.”**

**9h. Choose “Yes” to continue or “No” to cancel.**

**9i. Exit DSREPAIR.**

**10. Install the new hard disk.**

Follow the instructions provided by the manufacturer to verify that the disk is working. The new hard disk should have the same or larger storage capacity as the drive it replaces.

**11. Reinstall NetWare 4.**

After you copy NetWare 4 to the new hard disk, you are prompted to install Novell Directory Services on the server. You can install the server to its previous context or to another context.

If you choose a different context, NDS-style drive mappings to the old context are invalid. Bindery drive mappings are not affected.

**12. Use NDS Manager and the list you generated in Step 1 to replace replicas on the server.**

The completion time needed to restore replicas depends on the speed of your LAN or WAN environment.

**13. Use the backup system to restore the server data.**

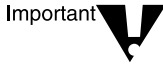
The backup system restores not only data but also file ownership and user trustee information.

If the backup system can't restore file ownership and trustees, you must create them manually.

**14. If needed, set the bindery context.**

# Monitoring and Maintaining Network Data

On all NetWare Directory Services servers, volume SYS: contains the Directory database for that server. The database files are stored in a hidden directory.



Volume SYS: must *not* run out of disk space. If volume SYS: runs out of space, it causes Transaction Tracking System™ (TTS™) software to shut down. This is reported to the Directory Services server console screen (DSTRACE screen), NDS Manager, or the DSREPAIR log file as a -621 error.

Novell Directory Services tracks all writes to its database using TTS. If TTS is disabled, writing information to the Directory is also disabled. Writes to the Directory aren't allowed unless TTS is enabled.

## Maintaining Sufficient Disk Space for Volume SYS:

To prevent volume SYS: from running out of space:

- ◆ Set minimum disk space alerts so that you are warned if the remaining space on volume SYS: drops below the minimum.

By default, NetWare sends a broadcast alert when the remaining space on a volume reaches 256 blocks. You can adjust the threshold by using the “SET Volume Low Warning Threshold” command at the server console.

- ◆ Store user files and applications on a volume other than SYS:.
- ◆ Store print queues on a volume other than SYS:.
- ◆ Add the following statement to the STARTUP.NCF file:

```
SET AUTO TTS BACKOUT FLAG = ON
```

This flag causes TTS to back out all transactions that were incomplete when the server failed.

This eliminates the need for the network supervisor respond to TTS-related prompts when the server comes up after a failure.

# Maintaining and Monitoring Backward Compatibility

You should upgrade all NetWare 4 servers to NetWare 4.11 for performance and administrative advantages.

However, during migration to NetWare 4.11, different versions of NetWare 4 and NetWare 3 will still interoperate.

## Maintaining Bindery Services in a NetWare 4 Environment

Some applications and services that run in the NetWare 4 environment do not currently take full advantage of Novell Directory Services technology. To enable users of these services to access them from the NetWare 4 environment, Novell offers bindery services.

With bindery services, NDS imitates a flat structure for leaf objects within an Organization or Organizational Unit object. Thus, when bindery services is enabled, all objects within the specified container can be accessed by NDS objects and by bindery-based servers and client workstations.



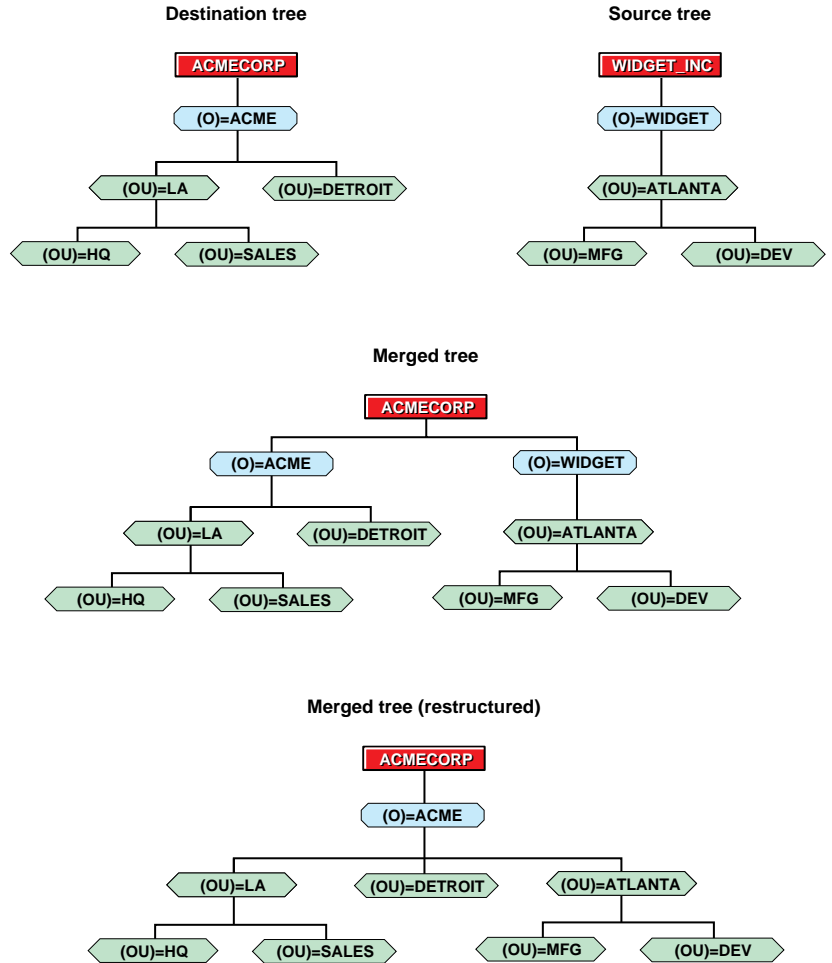
Bindery services applies only to leaf objects in the specified container object.

To enable bindery services, use the “SET BINDERY CONTEXT = *fully\_distinguished\_name*” parameter by using the SET command or the SERVMAN server utility. (See “SERVMAN” in *Utilities Reference*.) The container object you indicate with the SET BINDERY CONTEXT parameter is called the *bindery context*.

The following figure illustrates bindery services when an Organizational Unit object is specified as the bindery context.



**Figure 4-1**  
**Bindery Services in**  
**a Directory Tree**



A writable replica of the partition that includes the container object to be set as the bindery context must be stored on each server you want bindery services enabled on.

However, by default, only the first three servers installed on a partition receive a replica of the partition during the installation process and subsequently support bindery services.

You can add replicas to other servers if needed for bindery services. If a read/write or master replica is not present, use the NDS Manager or PARTMGR utility to add one to the server. For information and procedures, see “Creating and Managing Directory Services Partitions” on page 296.

## Maintaining Replicas in a Mixed NetWare 4 Environment

To maintain proper synchronization amongst NetWare 4 servers of different version, first upgrade servers that hold a replica of the [Root] partition in a tree to NetWare 4.11.

When upgrading NetWare 4.0x servers to NetWare 4.1x, the following rules apply to the Add, Split, Join, and Remove Partition operations and to the Change Replica Type operations:

- ◆ If the master replica of a partition resides on a NetWare 4.0x server, all partition operations can be performed in a mixed environment.
- ◆ Once the master replica of a partition has been moved to a NetWare 4.1x server, the master replica can't be moved back to a NetWare 4.0x server.
- ◆ You cannot perform the Add, Split, and Join Partition operations for that partition until all servers are upgraded to NetWare 4.1x, or until the NetWare 4.0x servers that have partition replicas have had those replicas removed.
- ◆ If a master replica of a partition resides on a NetWare 4.1x server, the Add, Split and Join Partition operations won't work if the NetWare 4.0x server contains a subordinate reference of the partition.
- ◆ The Remove Partition operation always works regardless of the master replica's location.
- ◆ The Change Replica Type operation works in a mixed environment *except* when the master replica has been moved to a NetWare 4.1x server. In this case the master replica can only be moved to another NetWare 4.1x server. However, you can only change replicas of a partition on servers running earlier versions of NetWare 4 to read/write or read-only.

The following matrix shows which partition operations are possible in a mixed environment.

The master replica column indicates the NetWare version on the server containing the master replica.

**Table 4-2**  
**Partition Operations Support for All NetWare 4 Versions**

Operation	Master replica	On a NetWare 4.01	On a NetWare 4.02	On a NetWare 4.1x
Add replica	NetWare 4.01	OK	OK	OK
	NetWare 4.02	OK	OK	OK
	NetWare 4.1x	Not OK	Not OK	OK
Change replica type	NetWare 4.01	OK	OK	OK
	NetWare 4.02	OK	OK	OK
	NetWare 4.1x	OK	OK	OK
Join partition	NetWare 4.01	OK	OK	OK
	NetWare 4.02	OK	OK	OK
	NetWare 4.1x	Not OK	Not OK	OK
Remove partition	NetWare 4.01	OK	OK	OK
	NetWare 4.02	OK	OK	OK
	NetWare 4.1x	OK	OK	OK
Split partition	NetWare 4.01	OK	OK	OK
	NetWare 4.02	OK	OK	OK
	NetWare 4.1x	Not OK	Not OK	OK

### Where to Go from Here

If you want to	Go to
Perform Directory tree-specific operations	Chapter 5, "Managing the Novell Directory Tree," on page 295

---

<b>If you want to</b>	<b>Go to</b>
Manage Directory objects	Chapter 1, "Managing Novell Directory Services Objects," on page 1
Manage the network file system and applications	Chapter 2, "Managing Directories, Files, and Applications," on page 97

---

## About Novell Directory Services

Novell® Directory Services™(NDS™) is a distributed name service that provides global access to all network resources regardless of where they are physically located. Users log into a multiserver network and view the entire network as a *single information system*.

This single information system is the basis for increased productivity and reduced administrative costs. You can manage NDS by using the utilities and programs described in this chapter.

The following utilities and programs help you manage the NDS database.

- ◆ **NDS Manager** (a graphical utility) and **PARTMGR** (a DOS utility) allow you to create and manage NDS partitions and replicas.



If you have a Windows\* or Windows 95\* workstation, you can use NDS Manager instead of PARTMGR to manage NDS partitions and replicas. NDS Manager has functionality that PARTMGR does not.

NDS Manager provides partitioning and replication services for the NDS database, as well as repair capabilities for repairing the database from a client workstation.

NDS Manager provides server and workstation services at a single client location, which reduces the need for administrators of NDS to run RCONSOLE or to work directly at a server console.

For instructions on using NDS Manager, refer to its online help system.

- ◆ **DSREPAIR** checks and repairs local portions of the database, similar to the way VREPAIR fixes volumes on a server.

- ◆ **DSMERGE** allows you to merge one Directory tree into another at the [Root], resulting in a single tree. This merging process would be used to create a single tree structure when previously separate organizations are joined together.
- ◆ **DSTRACE** allows you to determine whether NDS synchronization processes are complete and diagnose NDS errors.

## Creating and Managing Directory Services Partitions

### About Partitions and Replicas

A partition is a part of the total Directory and contains one or more containers and its associated leaf objects.

When a partition is subordinate to another in the Directory tree, it is referred to as a *child partition*. The partition above it is referred to as the *parent partition*.

You can make copies of a partition, called *replicas*, and store them on different servers in your network. Distributing replicas reduces network traffic by making information accessible locally and enabling users to utilize the network services even when a particular server is down.

Replicas also provide fault tolerance by ensuring that more than one copy of the partition information is available. For example, if a replica of the partition becomes unavailable, you can use a different replica to re-create it.



Partitions contain only NDS database information, *not* file and directory information.

## Planning and Using Partitions and Replicas

### What Happens During Installation?

By default, the installation utility adds a replica of the partition that contains the server's context only if the total of existing replicas is less than three.

However, if the server is not a NetWare<sup>®</sup> 4 server and contains bindery files (SYS:SYSTEM\NET\$\*.SYS) a replica will be added, regardless of the number of replicas.

These default settings ensure that bindery services will work correctly for networks running both NetWare 3<sup>™</sup> and 4 software.

For more information about bindery services, see "Maintaining Bindery Services in a NetWare 4 Environment" on page 290 and "Bindery services" in *Concepts*.

You can create additional partitions and replicas using the NDS Manager graphical utility or the PARTMGR text utility.

For more information on Directory partitions and replicas, see Chapter 4, "Determining a Partition and Replication Strategy" of *Guide to NetWare 4 Networks* and "Novell Directory partition" in *Concepts*.

### Setting Up NDS Manager

NDS Manager can be run as a standalone executable program from the SYS:PUBLIC directory.

You can also configure NDS Manager to run as a tool under the "Tools" menu in NetWare Administrator.

### Windows 3.1 Users

You can configure NDS Manager to run as a tool that can be accessed from NetWare Administrator's "Tools" menu. If you have not used NetWare Administrator yet, you need to open and close NetWare Administrator and then edit the NWADMN3X.INI file in the WINDOWS directory.

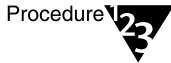
Add the following line to the [Snapin Object DLLs WIN 3X] section:

**NDSMGR = NMSNAP16.DLL**

## Windows 95 Users

To configure NDS Manager to run as a tool that can be accessed from NetWare Administrator's "Tools" menu, you must edit your system registry.

### Procedure



1. **Launch the Windows 95 NetWare Administrator and from the "Options" menu, choose "Save Settings on Exit."**
2. **Close NetWare Administrator.**
3. **Run REGEDIT.EXE (the Windows 95 editor).**
4. **Choose the following path:**  
  
`HKEY_CURRENT_USER\Software\NetWare\Parameters\NetWare Administrator`
5. **With "Snapin Object DLLs WIN 95" highlighted, from the "Edit" menu, choose "New" and then choose "String Value."**
6. **Type NDSMGR and press <Enter>.**
7. **With "NDSMGR" highlighted, from the "Edit" menu, choose "Modify."**
8. **Type NMSNAP32.DLL in the "Value Data" field and choose "OK."**

The next time you launch NetWare Administrator, you should see NDS Manager as an option under the "Tools" menu.



## Controlling Access to NDS Manager

If you are running Windows 3.1, you can control access to NDS Manager by restricting access to NDSMGR16.EXE and NMSNAP16.DLL.

If you are running Windows 95, you can control access to NDS Manager by restricting access to NDSMGR32.EXE and NMSNAP.DLL.

## Creating a New Partition

A partition can consist of one or more container objects and their associated leaf objects. A partition cannot contain only leaf objects. The container that is the first object in the partition is called the “root” of the partition.

When you create a new partition, you split the parent partition and end up with two partitions. The new partition becomes a child partition.

For example, if you select an Organizational Unit and choose to create it as a new partition, you are choosing to split the Organizational Unit from its parent partition ([Root], for example, which is always a partition). The Organizational Unit you selected becomes the partition root of a new partition.

The replicas of the parent partition will remain on the same servers, and information for the new partition will migrate from the parent partition’s replicas to the new partition’s replicas.

The master replica of the new partition will be stored on the same server as the master replica of the parent partition.

Creating a partition may take some time, since all of the replicas need to be synchronized with the new partition information.

When you create a new partition, the utility you use will inform you that the partition is created successfully, but the actual creating is still completing on the servers. You will need to wait a while before being able to perform another partition operation.

## Creating a Partition Using PARTMGR

Checklist



### Prerequisites

- A workstation logged in to the network, running DOS 3.30 or later
- A minimum of 512 KB of memory available on the workstation
- The Supervisor object right to the container object you are partitioning

Procedure



### Procedure

**1. At the DOS prompt, type**

`PARTMGR <Enter>`

**2. From the “Partition Administration” menu, choose “Manage Partitions.”**

Your current context appears in the upper-left corner of the screen.

**3. Select the container object to partition.**

- ◆ If the container you want to partition appears on the list, select it and press <F10>.
- ◆ If the container is not on the list, browse the directory by selecting containers and pressing <Enter> until you see the container you want. Select it and press <F10>.

**4. To create the new partition, choose “Yes.”**

The new partition is created when the process is completed on the servers. To see the partition icon that signifies that a container is a partition, you need to refresh the screen by choosing the up arrow and then expanding the parent container again.

A master replica is stored on the server where the parent partition’s master replica resides. An icon appears next to the Organization (O) or Organizational Unit (OU) to show that the container is the root of a partition.

To see where the master replica is stored, select the Organization (O) or Organizational Unit (OU) that you just partitioned, and then choose “View/Edit Replicas.” The server name appears in the “Replicas Stored on Server” column, and “Master” appears next to it in the “Type” column.

If you want to make additional replicas of this partition, see “Creating a Replica” on page 308.

For more information about	See
Partitions	“Novell Directory partition,” “Partition management,” and “Replica” in <i>Concepts</i>
Using the PARTMGR utility	“PARTMGR” in <i>Utilities Reference</i>

## Merging Partitions

You might want to merge two partitions if the Directory information in the two partitions is closely related.

In other words, you would merge a partition with its parent partition when you want to delete the partition without deleting the objects in the partition.

Consider keeping partitions separate if the partitions are large, because large partitions slow down response time.

The partition is merged when the process is completed on the servers. To see that the icon of the partition you merged is gone (which signifies that the merge is complete), you need to refresh the screen by choosing the up arrow and then expanding the container again.

Merging a partition with its parent partition might take some time, since the replicas need to be deleted and the parent replicas updated with the merging partition information.

### Merging Partitions Using PARTMGR

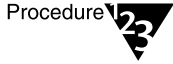
#### Prerequisites



- A workstation running DOS 3.30 or later
- A minimum of 512 KB of memory available on the workstation

- The Supervisor object right to the object at the root of the parent partition

### Procedure



**1. At the DOS prompt, type**

`PARTMGR <Enter>`

**2. From the “Partition Administration” menu, choose “Manage Partitions.”**

Your current context appears in the upper-left corner of the screen.

**3. Select the partition to merge.**

- ◆ If the partition appears on the list, select it and press <F10>.
- ◆ If the partition is not on the list, browse the directory by selecting objects and pressing <Enter> until you see the partition you want. Select it and press <F10>.

**4. Choose “Merge with the Parent Partition.”**

**5. To merge the selected partition with its parent partition, choose “Yes.”**

The partition is merged when the process is completed on the servers. To see that the icon of the partition you merged is gone (which signifies that the merge is complete), you need to refresh the screen by choosing the up arrow and then expanding the container again.

Merging a partition with its parent partition might take some time, since the replicas need to be deleted and the parent replicas updated with the merging partition information.

For more information about	See
Partitions	“Novell Directory partition,” “Partition management,” and “Replica” in <i>Concepts</i>
Using the PARTMGR utility	“PARTMGR” in <i>Utilities Reference</i>

## Moving a Partition

You can move a container object only if it is the root of a Directory partition that has no subordinate partitions. So, moving a container is really moving a partition.

When you move a container object, Novell Directory Services (NDS) changes all references to the container. Although the object’s common name remains unchanged, the context name of the container (and of all its subordinates) changes.

When you move a partition, create an alias object that points to the partition you’re moving. Doing so allows users to continue logging into the network and finding objects in their original Directory location.



If you move a partition and do not create an alias, users who are unaware of the partition’s new location will not easily find objects in the Directory tree, since they will look for them in their original Directory location.

This might also cause client workstations to fail at login if the NAME CONTEXT parameter in the NET.CFG file is set to the original location in the Directory tree.

Because the context of an object changes when you move it, users whose name context in their configuration file (NET.CFG file) references the moved object need to update their NET.CFG so that it references the object’s new name.

To automatically update users’ NET.CFG file with a new name context after moving an object, use the NCUPDATE utility. For instructions, see “NCUPDATE” in *Utilities Reference*.

## Moving a Partition Using NETADMIN

### Prerequisites



Checklist

- A DOS workstation running DOS 3.30 or later and the NETADMIN utility
- The Create object right to the destination container

### Procedure



Procedure

1. **At the DOS prompt, type**

**NETADMIN** <Enter>

For information on moving around in NETADMIN and selecting objects, press <F1> after starting the utility. To see which container objects in the Directory tree are partitions, exit NETADMIN and type "PARTMGR" at the command line. Then browse the tree.

2. **From the NETADMIN options menu, choose "Manage Objects."**

Your current context appears in the upper-left corner.

3. **Select the object that you want to move.**

- ◆ If the object you want to move appears on the list, select it and press <F10>.
- ◆ If the object is not on the list, browse the directory by selecting container objects and pressing <Enter> until you see the object you want. Select it and press <F10>.

4. **From the "Actions" menu, choose "Move."**

You can move a container object only if it is the root of a Directory partition, and only if it contains no subordinate partitions.

In NETADMIN, when you select a container object that is a partition, the context-sensitive help at the bottom of the screen reads "This is a partition." Also, an asterisk (\*) is displayed in front of the object name.

If the container you want to move is not a partition, you must first use a partition management utility (PARTMGR or NetWare Administrator) and create the container as a new partition.

5. **Use the Down-arrow key and highlight the “New Context” field.**
6. **Assign a new context to the object you want to move.**
  - ◆ If you know the new context that you want the object to be in, type the new context in the highlighted field.
  - ◆ If you don't know the new context that you want the object to be in, press <Insert> twice to browse the Directory for the destination container; then select the destination container and press <F10>.
7. **To accept the new context as the destination container, press <Enter>.**
8. **To confirm that you want to move the object listed in the “Old Context” field to the container listed in the “New Context” field, press <F10>.**
9. **To create an alias in place of the moved container, choose “Yes.”**

The alias object will point to the partition's new location, and the selected object is moved to the destination container.



If you move an object do not create an alias, users who are unaware of the object's new location will not easily find objects in the Directory tree, since they will look for them in their original Directory location.

This might also cause client workstations to fail at login if the NAME CONTEXT parameter in the NET.CFG file is set to the original location in the Directory tree.

Because the context of an object changes when you move it, users whose name context in their configuration file (NET.CFG file) references the moved object need to update their NET.CFG so that it references the object's new name.

To automatically update users' NET.CFG file with a new name context after moving an object, use the NCUPDATE utility. For instructions, see “NCUPDATE” in *Utilities Reference*.



You will need to wait for processes throughout the Directory to be complete before you can perform a partition operation with this object again.

Unless you want the partition you just moved to remain a partition, you should merge it with its parent partition to avoid having an unnecessary partition in the Directory tree. See “Merging Partitions” on page 301.

For more information about	See
Objects	“Object” in <i>Concepts</i>
Rights	“Rights” in <i>Concepts</i>
Directory tree	“Directory tree” in <i>Concepts</i>
Using the NETADMIN utility	“NETADMIN” in <i>Utilities Reference</i>

## Aborting a Partition Operation

If you have begun the process of creating, merging, or moving a partition, or changing a replica type, you can still abort the process since partition operations take time. You can abort a partition operation only before the operation is in its final stages.

You would want to use this feature if you begin a partition operation and find that your database will not synchronize.

If Novell Directory Services (NDS) cannot synchronize replica information in your database because it is corrupted, or because a server in your Directory tree is down, you probably want to abort any partition operation in progress.

If you choose to abort a partition operation when there is no operation in progress, no partitions will be affected.



## Aborting a Partition Operation Using PARTMGR

Checklist



### Prerequisites

- A workstation running DOS 3.30 or later
- A minimum of 512 KB of memory available on the workstation
- The Supervisor object right to the object at the root of the partition

Procedure



### Procedure

1. **At the DOS prompt, type**

`PARTMGR` <Enter>

2. **From the “Partition Administration” menu, choose “Manage Partitions.”**

Your current context appears in the upper-left corner.

3. **Select the parent partition that is involved in a partition operation.**

- ◆ If the partition appears on the list, select it and press <F10>.
- ◆ If the partition is not on the list, browse the directory by selecting objects and pressing <Enter> until you see the partition you want. Select it and press <F10>.

4. **Choose “Abort Partition Operation.”**

A list of the replicas of the selected partition appears. Each replica’s type and state are also displayed.

As long as at least one of the replicas has not yet finished the operation you had begun, you can still abort the operation. If the state of the replica is “On,” all operations are complete and cannot be aborted.

5. **To abort the partition operation, press <F10> and choose “Yes.”**

The partition operation is aborted, and any replicas that began to be merged or created (depending on the operation you had begun) are returned to their previous state.

For more information about	See
Partitions	“Novell Directory partition,” “Partition management,” and “Replica” in <i>Concepts</i>
Using the PARTMGR utility	“PARTMGR” in <i>Utilities Reference</i>

## Creating a Replica

When you create a partition, a master replica is automatically created and stored on the server where the parent partition’s master replica resides. You can create additional replicas of the partition, within these guidelines:

- ◆ You can have only one master replica. Additional replicas must be read/write or read-only. For a description of replica types, see “Planning and Using Partitions and Replicas” on page 297.
- ◆ You can store only one replica of a partition on a server.

### Creating a Replica Using PARTMGR



#### Prerequisites

- A workstation running DOS 3.30 or later
- A minimum of 512 KB of memory available on the workstation
- The Supervisor object right to the object at the root of the partition



#### Procedure

1. **At the DOS prompt, type**  
  
`PARTMGR <Enter>`
2. **From the “Partition Administration” menu, choose “Manage Partitions.”**

Your current context appears in the upper-left corner.

**3. Select the partition to replicate.**

- ◆ If the partition appears on the list, select it and press <F10>.
- ◆ If the partition is not on the list, browse the tree by selecting objects and pressing <Enter> until you see the partition you want. Select it and press <F10>.

**4. Choose “View/Edit Replicas.”**

A list of the replicas of the selected partition appears. Each replica’s type is also displayed.

**5. To add a replica to the server, press <Insert>.**

**6. Enter the replica information.**

- 6a. At the “Replica Type” field, press <Enter>.**
- 6b. Choose the type of replica you want to create from the “Replica Type” menu at the top of the screen.**
- 6c. At the “Store on Server” field, press <Enter>.**
- 6d. Type the name of the server you want to add the replica to, or press <Insert> to select a server from the browser.**
- 6e. To create the replica, press <Esc> or <F10> and choose “Yes.”**

The new replica appears on the list of replicas for the server.

---

<b>For more information about</b>	<b>See</b>
Partitions	“Novell Directory partition,” “Partition management,” and “Replica” in <i>Concepts</i>
Using the PARTMGR utility	“PARTMGR” in <i>Utilities Reference</i>

---

## Deleting a Replica

When you delete replicas, keep the following guidelines in mind:

- ◆ If a master replica becomes corrupted (for example, if the server will be down for a long time or the master replica becomes corrupted), change a read/write or read-only replica on another server to the master replica. This automatically changes the old master replica to a read/write replica.
- ◆ For fault tolerance, you should maintain at least one replica of the master partition on different servers.

### Deleting a Replica Using PARTMGR

Checklist



#### Prerequisites

- A workstation running DOS 3.30 or later
- A minimum of 512 KB of memory available on the workstation
- The Supervisor object right to the object at the root of the partition whose replica you want to delete

Procedure



#### Procedure

1. **At the DOS prompt, type**

`PARTMGR <Enter>`

2. **From the “Partition Administration” menu, choose “Manage Partitions.”**

Your current context appears in the upper-left corner.

3. **Select the partition that has a replica you want to delete.**
  - ◆ If the partition appears on the list, select it and press <F10>.
  - ◆ If the partition is not on the list, browse the directory by selecting objects and pressing <Enter> until you see the partition you want. Select it and press <F10>.

**4. Choose “View/Edit Replicas.”**

A list of the replicas of the selected partition appears. Each replica’s type is also displayed.

**5. Select the replica to delete and press <Delete>.**

You cannot delete a master replica. If the replica you want to delete is a master, go to a server with another replica of the master and make it the new master replica. This automatically changes the old master replica to a read/write replica, which you can then delete.

For instructions, see “Viewing a List of Partitions in a Directory Tree” on page 317.

**6. To delete the replica, choose “Yes.”**

For more information about	See
Partitions	“Novell Directory partition,” “Partition management,” and “Replica” in <i>Concepts</i>
Using the PARTMGR utility	“PARTMGR” in <i>Utilities Reference</i>

## Sending Updates to Other Replicas

Although Novell Directory Services automatically synchronizes the directory data of replicas (so that each replica contains the most recently updated data), you can manually start the process to synchronize (update) the directory data of replicas, if necessary.

You should use the DSREPAIR utility to discover if the data in some replicas is out of sync with the master replica or not. If the data is out of sync, you would want to manually send updates to those replicas. The data in the other replicas would be updated and the directory data of each replica would be synchronized.

## Sending Updates Using PARTMGR

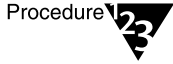


### Prerequisites

- A workstation running DOS 3.30 or later
- A minimum of 512 KB of memory available on the workstation

- The Supervisor object right to the object at the root of the partition whose replicas you want to send updates to

### Procedure



**1. At the DOS prompt, type**

`PARTMGR` <Enter>

**2. From the “Partition Administration” menu, choose “Manage Partitions.”**

Your current context appears in the upper-left corner.

**3. Select the partition whose replicas you want to update.**

- ◆ If the partition appears on the list, select it and press <F10>.
- ◆ If the partition is not on the list, browse the tree by selecting objects and pressing <Enter> until you see the partition you want. Select it and press <F10>.

**4. Choose “View/Edit Replicas.”**

A list of the replicas of the selected partition appears. Each replica’s type is also displayed.

**5. Select the replica you want to send updates from and press <F10>.**

**6. Choose “Send Updates to Other Replicas.”**

**7. To send updates to all the other replicas, choose “Yes.”**

The replica information is sent to all other replicas of the partition (including the master replica).

For more information about	See
Partitions	“Novell Directory partition,” “Partition management,” and “Replica” in <i>Concepts</i>
Using the PARTMGR utility	“PARTMGR” in <i>Utilities Reference</i>

## Receiving Updates from Other Replicas

Although Novell Directory Services (NDS) automatically synchronizes the directory data of replicas (so that each replica contains the most recently updated data) you can manually synchronize (update) the directory data of replicas if they ever get out of sync.

You should use the DSREPAIR utility to discover if the data in some replicas is out of sync with the master replica or not. If the data is out of sync, you would want to manually receive updates from the Master replica.

You cannot choose “Receive Updates From Other Replicas” from a master replica. The master is assumed to be the most current and accurate copy of the partition. If it’s not, you should assign one of the other replicas to be the master using the PARTMGR utility.

If you choose “Receive Updates From Other Replica” from any replica, that replica will receive NDS information from the master.

## Receiving Updates Using PARTMGR



### Prerequisites

- A workstation running DOS 3.30 or later
- A minimum of 512 KB of memory available on the workstation
- The Supervisor object right to the object at the root of the partition whose replicas you want to update

**Procedure**

- 1. At the DOS prompt, type**

`PARTMGR <Enter>`

- 2. From the “Partition Administration” menu, choose “Manage Partitions.”**

Your current context appears in the upper-left corner.

- 3. Select the partition whose replicas you want to update.**

- ◆ If the partition appears on the list, select it and press <F10>.
- ◆ If the partition is not on the list, browse the tree by selecting objects and pressing <Enter> until you see the partition you want. Select it and press <F10>.

- 4. Choose “View/Edit Replicas.”**

A list of the replicas of the selected partition appears. Each replica’s type is also displayed.

- 5. Select the replica you want to update and press <F10>.**

- 6. Choose “Receive Updates from Other Replicas.”**

- 7. To receive updates from all the other replicas, choose “Yes.”**

The selected replica receives NDS information from the master replica.

For more information about	See
Partitions	“Novell Directory partition,” “Partition management,” and “Replica” in <i>Concepts</i>
Using the PARTMGR utility	“PARTMGR” in <i>Utilities Reference</i>

**Viewing a List of Partitions Stored on a NetWare Server**

When you view a list of partitions stored on a NetWare server, you are seeing all the partitions that have a replica stored on the selected server and the type of each replica.



## Listing Partitions Using PARTMGR

Checklist



### Prerequisites

- A workstation running DOS 3.30 or later
- A minimum of 512 KB of memory available on the workstation
- The Write property right to the ACL property of the NetWare Server object whose partitions you want to view

Procedure



### Procedure

1. **At the DOS prompt, type**  
`PARTMGR <Enter>`
2. **From the “Partition Administration” menu, choose “Manage Partitions.”**  

Your current context appears in the upper-left corner.
3. **Select the server whose partitions you want to list.**
  - ◆ If the server appears on the list, select it and press <F10>.
  - ◆ If the server is not on the list, browse the tree by selecting containers and pressing <Enter> until you see the server you want. Select it and press <F10>.

A list of partitions stored on the server appears.

For more information about	See
Partitions	“Novell Directory partition,” “Partition management,” and “Replica” in <i>Concepts</i>
Using the PARTMGR utility	“PARTMGR” in <i>Utilities Reference</i>

## Viewing a List of Replicas of a Partition

You can see a list of a partition’s replicas, the servers where the replicas are stored, and whether a replica is a master, read/write, read-only, or subordinate reference replica type.

### Listing Replicas Using PARTMGR



#### Prerequisites

- A workstation running DOS 3.30 or later
- A minimum of 512 KB of memory available on the workstation
- The Write property right to the ACL property of the Server object whose replicas you want to view



#### Procedure

1. **At the DOS prompt, type**  
`PARTMGR <Enter>`
2. **From the “Partition Administration” menu, choose “Manage Partitions.”**  
Your current context appears in the upper-left corner.
3. **Select the partition whose replicas you want to list.**
  - ◆ If the partition appears on the list, select it and press <F10>.
  - ◆ If the partition is not on the list, browse the tree by selecting containers and pressing <Enter> until you see the partition you want. Select it and press <F10>.
4. **Choose “View/Edit Replicas.”**

The “Replicas Stored on Server” screen appears, which lists the replicas of the selected partition, the server they reside on, and the type of each replica.

For more information about	See
Partitions	“Novell Directory partition,” “Partition management,” and “Replica” in <i>Concepts</i>
Using the PARTMGR utility	“PARTMGR” in <i>Utilities Reference</i>

## Viewing a List of Partitions in a Directory Tree

You can see a list of all partitions to which you have Browse rights in a Novell Directory Services (NDS) tree using the NDS Manager utility. For instructions or help, see the online help in NDS Manager.

## Changing a Replica’s Type

You can change replica types according to the following guidelines:

- ◆ You can have only one master replica of a partition. Creating a new master replica automatically changes the old master replica to a read/write replica.
- ◆ You can change read/write replicas to read-only, and vice versa, without affecting other replicas of the same partition.

## Changing a Replica’s Type Using PARTMGR



### Prerequisites

- A workstation running DOS v3.30 or later
- The Supervisor object right to the object at the root of the partition

## Procedure

1. **At the DOS prompt, type**

`PARTMGR <Enter>`

2. **From the “Partition Administration” menu, choose “Manage Partitions.”**

Your current context appears in the upper-left corner.

3. **Select the partition whose replica you want to change.**

- ◆ If the partition is on the list, select it and press <F10>.
- ◆ If the partition is not on the list, browse the tree by selecting partitions and pressing <Enter> until you see the partition you want. Select it and press <F10>.

4. **Choose “View/Edit Replicas.”**

A list of the replicas of the selected partition appears. Each replica’s type is also displayed.

5. **Select the replica you want to change and press <F10>.**

6. **Choose “Change Replica Type.”**

7. **Press <Enter> and choose the replica type you want the replica to become.**

8. **To save the replica as the new type, press <F10>.**

The new replica type appears on the list. The new replica type appears on the “Partition Replicas” screen.

If you changed a replica type to a master and a master replica already existed, the replica you just changed to master is now the master replica and the old master replica has been changed automatically to a read/write replica.

For more information about	See
Partitions	“Novell Directory partition,” “Partition management,” and “Replica” in <i>Concepts</i>
Using the PARTMGR utility	“PARTMGR” in <i>Utilities Reference</i>

## Removing Novell Directory Services from a Server

### Considerations Before Removing NDS

Removing Novell Directory Services (NDS) from a server may corrupt your NDS database. In most cases, this procedure is not necessary to correct a NetWare 4 problem. Before removing NDS, ask

- ◆ Do other servers get Directory information (such as partition replicas) from this server?
- ◆ Could a bad LAN driver (one that doesn’t communicate properly with NDS) be causing the problem?
- ◆ Could routers, network boards, or other hardware components be causing the problem?

If you answered “yes” to any of these questions, only remove NDS as a last resort, after resolving all other problem areas.

By removing NDS from a server, you remove the NetWare Server object from the Directory tree and downgrade the server’s volumes to bindery volumes. Trustee assignments and all NDS information, such as links to subordinate partitions, are lost.

If you installed this server into the wrong container, it isn’t necessary to remove NDS. Use the NetWare Administrator utility to move the Server object to the correct container.



Removing NDS may corrupt your Directory database. You must remove NDS if you are reformatting this server’s hard drive. Do not remove NDS unless Novell Technical Support advises you to remove NDS from this server.

## Removing NDS from a Server

Checklist



### Prerequisites

- Access to the server console.
- The Supervisor object right to the NetWare Server object and its associated Volume objects.
- Make sure all of the server's volumes are mounted. Unmounted volumes won't get their Volume objects removed from the Directory database.

Procedure



### Procedure

1. **At the server console, type**  
  
`LOAD INSTALL <Enter>`
2. **From the “Installation Options” menu, select “Directory Options (Install Novell Directory Services)” and press <Enter>.**
3. **From the “Directory Services Options” menu, select “Remove Directory Services from this Server” and press <Enter>.**
4. **At the confirmation prompt, choose “Yes.”**  
  
The “Directory Services Login/Authentication” screen appears.
5. **Type the password for User ADMIN in the “Password” field and press <Enter>.**

After you enter the password, the server's mounted volumes are downgraded and a message displays the number of volumes affected. Then the system checks for Directory connections to other servers.

6. **(Conditional) If this server contains a master replica, you must designate another server to hold it. Choose one of the following and press <Enter>:**

- ◆ Do it automatically.

INSTALL finds the first server with a replica of this partition and changes its type to “master.”

- ◆ Designate the server yourself.

Highlight the server where you want the master replica located.

Press <F10> to save and continue.

A message notifies you that the master replica has moved.

7. **To continue, press <Enter>.**

INSTALL removes NDS and deletes the Server object and Volume objects associated with it from the Directory database.



If a Directory link is down (such as another server containing objects from this server), you must use NDS Manager to delete the Server and Volume objects from the Directory database.

8. **To exit INSTALL, press <Esc>.**

## Reinstalling NDS on a Server

This procedure reinstalls Directory Services on a server. It doesn't preserve the trustee assignments from the first time NDS was installed on the server; you must make those assignments again.

### Prerequisites



- Access to the server console
- The Supervisor object right to the container you want to install the server in

### Procedure

1. **At the server console, type**  
  
`LOAD INSTALL <Enter>`
2. **From the “Installation Options” menu, select “Directory Options (Install Novell Directory Services)” and press <Enter>.**
3. **From the “Directory Services Options” menu, select “Install Directory Services onto this Server” and press <Enter>.**
4. **Install Directory Services on the server.**  
  
To select a Directory tree and install Directory Services on the server, follow the instructions in Chapter 2, “Simple Installation,” or Chapter 3, “Custom Installation,” of *Installation*.
5. **To exit INSTALL, press <Esc>.**

## Deleting a NetWare Server Object from the NDS Database

### Considerations Before Deleting NetWare Server Objects



Deleting a NetWare Server object permanently removes it from your network! It also permanently removes its data and resources from the network.

Deleting a NetWare Server object may corrupt your NDS database, especially if the Server object provides NDS database services (such as storing partition replicas). Before deleting the Server object with the NDS Manager utility, consider these alternatives:

- ◆ Change the master replicas stored on this server to read/write replicas and then delete all replicas on the server. Once all the processes are complete, you can delete the server.
- ◆ Remove NDS from the server with the INSTALL NLM (described in “Removing NDS from a Server” on page 320). This procedure protects your NDS database from lost services.
- ◆ To move the NetWare Server object to another context, use the “Move Server Object” option in the NetWare Administrator



utility. (You do *not* need to delete the Server object and re-create it in another context.)

## Deleting a NetWare Server Object Using PARTMGR



### Prerequisites

- A workstation running DOS v3.30 or later.
- A minimum of 512 KB of memory available on the workstation.
- The Supervisor object right to the container of the Server object you want to delete.
- Create a new master replica (if a master replica is stored on the NetWare Server object). See “Viewing a List of Partitions in a Directory Tree” on page 317.



### Procedure

- 1. At the server console, bring down the server by typing**

`DOWN <Enter>`

For more information, see “Bringing Down a Server” on page 405.

- 2. At your workstation's DOS prompt, type**

`PARTMGR <Enter>`

- 3. From the “Partition Administration” menu, choose “Manage Partitions.”**

Your current context appears in the upper-left corner.

#### 4. Select the NetWare Server object you want to delete.

- ◆ If the NetWare Server object appears on the list, select it and press <Delete>.
- ◆ If the NetWare Server object is not on the list, browse the tree by selecting objects and pressing <Enter> until you see the NetWare Server object you want. Select it and press <Delete>.

The NetWare Server object is deleted from the NDS database.



It may take a long time for all the other servers to know that a server is down. You should wait awhile after downing a server before deleting it.

For more information about	See
Deleting objects from the NDS database	"Moving Container Objects Using NETADMIN" on page 76
Using the PARTMGR utility	"PARTMGR" in <i>Utilities Reference</i>

## Repairing the Novell Directory Database

The DSREPAIR utility is provided with NetWare 4™ software to repair problems with Novell Directory Services on a single-server basis. It does not correct problems on other servers from a single, centralized location. It must be run on each server that you want to correct Directory database errors on.

### DSREPAIR Overview

The DSREPAIR utility allows you to maintain and repair the local Novell Directory database of a tree. This utility performs the following operations:

- ◆ Repairs the local database
- The repair is performed for the DS.NLM file stored on the current server you are running the DSREPAIR utility on.

- ◆ Repairs local replicas

You are provided with tools to repair replicas, replica rings, and server objects. You can also view the purge time of each replica to ensure that data in each replica is the same.

- ◆ Analyzes each server in each local partition for synchronization errors

You can view errors and list the partition name, server name, synchronization time, and error code for each error.

- ◆ Writes replica information to a log file

The log file contains detailed information about local partitions and servers. This information helps you diagnose damage to the database.

- ◆ Creates a dump file of a damaged database

The dump file is saved in a compressed format. You can use DSREPAIR to diagnose and repair the damaged database.

- ◆ Checks the remote server ID list

You can access a list of the identification numbers for remote servers. You can use this list to verify the identification numbers of remote servers and modify the numbers if you need to.

- ◆ Searches for local database objects

A browser allows you to locate and synchronize objects in the local database.

Some NDS database problems are not fatal, and Directory Services continues to operate. But if the database becomes corrupted, you get a message on the console that the server could not open the local database. In this case, run DSREPAIR or reinstall the NDS database to fix the problem so that the database can be opened.



DSREPAIR affects only the parts of the database stored on the server where you run it. To fix the entire database, you must run the utility on each server which contains a part of the database.



DSREPAIR changes inconsistent objects to Unknown objects when they do not have mandatory properties or are invalid in other respects (their properties don't meet minimum requirements for an object type). Unknown objects can be deleted but cannot be changed back to their original object type.

In NetWare 4.11, Unknown objects are represented by question mark icons in the NetWare Administrator utility.

## DSREPAIR Options

After you load DSREPAIR, you can use the following options:

Option	Use to
Unattended Full Repair	Automatically perform all possible repair operations to the Directory database that do not require operator assistance.
Time Synchronization	Contact all servers within this server's local database to request information about Directory Services and time synchronization.  If a replica of the root partition is contained on this server, then all servers in the Directory tree are contacted.
Replica Synchronization	Determine the status of synchronization for every replica in the replica table for the Directory tree.  The status of synchronization can inform you of the current condition of the Directory tree.
View/Edit Repair Log File	Track all operations of the DSREPAIR utility to a single file. The default log file is <code>SYS:SYSTEM\DSREPAIR.LOG</code> .  You can configure options for the log file by accessing "Log File And Login Configuration" in the "Advanced Options" menu.
Advanced Options Menu	The "Advanced Options" menu allows you to manually perform individual or global repair operations on the Directory tree. You can also access diagnostic information about the Directory tree database to analyze the status of the tree.  See "Using the Advanced Options" on page 333 for more information.

## Running an Unattended Full Repair

Use this procedure to perform an automatic repair of the Directory database. Any operation requiring an operator's assistance, such as managing partition replicas or editing remote server ID numbers, is not performed.

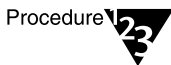
If you want to manually repair the Directory database, use options available in the "Advanced Options" menu. See "Using the Advanced Options" on page 333 for more information.

### Prerequisites



- Access to the server console or an established RCONSOLE session with the server
- All servers in a tree using the same time source
- The Supervisor object right to the [Root] object of the Directory tree

### Procedure



1. **At the server console prompt, load the module by typing**

```
LOAD DSREPAIR <Enter>
```

If you have placed DSREPAIR in a directory other than SYS:SYSTEM, you must enter the full path to the utility.

The utility locks the database.

## 2. Choose “Unattended Full Repair.”

The “Repairing Directory on Server *servername*” screen appears. A window is available to observe the repairs in process.

Following the automatic repair, a message window appears that informs you of the repair status, the total number of errors corrected, and the amount of time used to complete the repair operation.

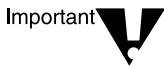
## 3. Press <Enter> to display the error log file.

The error log is displayed within a full text editor. You can annotate or modify the DSREPAIR log if you want to.

## Checking Time Synchronization (DSREPAIR)

Use this procedure on the server before or after performing a repair. It allows you to contact all servers within this server’s local database to request information about Directory Services and time synchronization.

If a replica of the root partition is contained on this server, then all servers in the Directory tree are contacted.

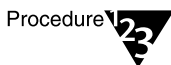


Time synchronization is very important to Directory Services. All servers in a tree must be synchronized to the same time source. If they are not, collision will occur when synchronizing objects in replicas.



### Prerequisites

- Access to the server console or an established RCONSOLE session with the server
- All servers in a tree using the same time source



### Procedure

1. **At the server console prompt, load the module by typing**

```
LOAD DSREPAIR <Enter>
```

If you have placed DSREPAIR in a directory other than SYS:SYSTEM, you must enter the full path to the utility.

The utility locks the database.

## 2. Choose “Time Synchronization.”

The “Collecting Time Synchronization and Server Status” screen appears. A window is available to observe the operations in process.

Following the operation, the DSREPAIR log is displayed within a full text editor. You can annotate or modify the DSREPAIR log if you want to.

The DSREPAIR log contains the following:

Field	Indicates
Server Name	All of the server names known to the local Directory database. If this server contains a replica of the root partition, then this list contains all the servers in the tree.
Version	The version of DS.NLM running on the server.
Replica Depth	The replica depth field reports “-1” if no replicas are stored on the server or “0” if the server contains a replica of the root partition. A positive integer indicates how many objects deep from the root the first replica is on that server.
Time Source	<p>The time server type. This information helps you determine if time synchronization for all the trees in the server is configured properly.</p> <p>All servers in a tree must be using the same time source.</p> <p>For example, if there are two Single time servers then you know that all servers in the tree cannot be polling the same time source and there is a configuration problem.</p>
Time in Sync	The local time synchronization status on each server. The status should be “Yes.” If the status is “No,” then the server is not able to contact its time source.

Field	Indicates
Time +/-	<p>The difference in time between the local server and the selected server in the list. All servers should be within one second of each other; if they are not, they have not been configured properly.</p> <p>This field reports up to 999 minutes and 59 seconds (which is approximately 16 hours and 30 minutes) in the form <i>minutes:seconds</i>. If the time difference is greater than 16 hours and 30 minutes, then the maximum value is displayed as: -999:59.</p> <p>If the difference in time is more than a few minutes, it might indicate that the servers are using different time source servers.</p>

## Checking Replica Synchronization

Use this procedure on the server to determine the status of synchronization for every replica in the replica table for the Directory tree.

The synchronization status can inform you of the current condition of the Directory tree.

If you want to manually manage the Directory partitions and replicas, use the “Replica And Partition Operations” option in the “Advanced Options” menu. See “Using the Advanced Options” on page 333 for more information.



Normal partitioning operations should be done with one of the client utilities (NDS Manager or PARTMGR). The “Replica Synchronization” option should only be used when the master replica of a partition has been lost because of server or hardware failure and the server will be reinstalled into the Novell Directory tree.



You need to synchronize damaged replicas manually, using the PARTMGR utility or NDS Manager.





Warning

Be careful when changing a secondary replica to a master. If a server containing a secondary is changed to a master and the server containing the original master is brought back up, there is a possibility that the partition will have two master replicas.

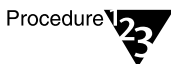


Checklist

### Prerequisites

- Access to the server console or an established RCONSOLE session with the server
- The Supervisor object right to the [Root] object of the Directory tree

### Procedure



Procedure

1. **At the server console prompt, load the module by typing**

```
LOAD DSREPAIR <Enter>
```

If you have placed DSREPAIR in a directory other than SYS:SYSTEM, you must enter the full path to the utility.

The utility locks the database.

2. **Choose “Replica Synchronization.”**

The “Log In as the Admin” screen appears.

3. **Enter the administrator name and password to log in to the tree.**

Log in as a user who has the Supervisor object right to the [Root] object of the tree. Enter your complete name (Distinguished Name), such as ADMIN.NOVELL or CN=ADMIN.O=NOVELL. Entering only ADMIN is invalid because it is not a complete name.

4. **Press <Enter>.**

The “Collecting Replica Synchronization And Server Status” screen appears. A window is available to observe the operations in process.

Following this operation, the DSREPAIR log is displayed within a full text editor. You can annotate or modify the DSREPAIR log if you want to.

The error log contains the following fields:

Field	Indicates
Servers That Contain Replicas	The servers in the tree that contain replicas.
Replica Type	<p>The type of replica for each server that contains replicas of partitions.</p> <p>Following is a list of the possible types of replicas.</p> <p><b>Master.</b> This is a writable replica that can also handle partition operations. There is only one master replica per partition. Only one partition operation is valid at any time for a partition, and the master enforces that requirement. For all nonpartition operations, this replica is equivalent to a read/write replica.</p> <p><b>Read/Write.</b> This is a writable replica that can be updated from a client workstation. Both read/write and master replicas are valid for login and authentication requests.</p> <p><b>Read-Only.</b> This is a replica that cannot be changed from a client workstation. It is updated with the changed data in the replica from another read/write or master. This replica cannot be used for bindery services because bindery services requires a writable replica to be contained on the server for bindery users.</p> <p><b>Subordinate Reference.</b> This is a replica of the root partition which includes the replica list (ring). As a child partition, it resides on every server that holds a copy of it's parent partition.</p> <p>This replica is used to facilitate tree connectivity.</p>
Status	The synchronization status of partition replicas for servers in the tree. The server running DSREPAIR does not synchronize to itself, so the status for the server's own replica is displayed as "Host".

## Viewing and Editing the Repair Log File

Use this procedure on the server to view and edit repair information for the local Directory tree.

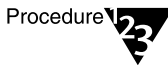
The default log file is `SYS:SYSTEM\DSREPAIR.LOG`. You can change the filename with the “Log File and Login Configuration” option in the “Advanced Options” menu. See “Using the Advanced Options” on page 333 for more information.

### Prerequisites



- Access to the server console or an established RCONSOLE session with the server
- The Supervisor object right to Directory objects in the local tree

### Procedure



1. **At the server console prompt, load the module by typing**

```
LOAD DSREPAIR <Enter>
```

If you have placed DSREPAIR in a directory other than `SYS:SYSTEM`, you must enter the full path to the utility.

The utility locks the database.

## Using the Advanced Options

Use this procedure to access the “Advanced Options” for manual repair of the Directory database.

If you want the Directory database to be repaired automatically, use the options available from the “Unattended Full Repair” option in the main menu. See “Running an Unattended Full Repair” on page 327 for more information.

The “Advanced Options” menu includes the following options:

- “Log File and Login Configuration”
- “Repair Local DS Database”
- “Servers Known to this Database”
- “View Remote Server ID List”
- “Replica and Partition Operations”
- “Check Volume Objects and Trustees”
- “Check External References”
- “Security Equivalence Synchronization”
- “Global Schema Operations”
- “View/Edit Repair Log File”
- “Create a Database Dump File”

### Prerequisites



- Access to the server console or an established RCONSOLE session with the server
- The Supervisor object right to the [Root] object in the tree

### Procedure



- 1. At the server console prompt, load the module by typing**  
  
`LOAD DSREPAIR <Enter>`  
  
If you have placed DSREPAIR in a directory other than SYS:SYSTEM, you must enter the full path to the utility.  
  
The utility locks the database.
- 2. Choose “Advanced options menu.”**
- 3. From the menu, select the repair operation you want to perform.**

Refer to the online help in DSREPAIR for more information and instructions on how to use these options in the DSREPAIR utility.

For more information about	See
Directory Services database	"Novell Directory Services" in <i>Concepts</i>
DSREPAIR utility	"DSREPAIR" in <i>Utilities Reference</i>

## Merging NDS Trees

The DSMERGE utility allows you to merge the [Root] of two separate NDS trees. Only the [Root] objects are merged; container objects and their leaf objects maintain separate identities within the newly merged [Root].

### DSMERGE Overview

The two trees you merge are called the local source tree and the target tree. To merge two trees, you load DSMERGE on a server in the local tree.

DSMERGE does not change Directory names or contexts within the containers. Object and property rights for the merged objects are retained.



You can't merge container or leaf objects with DSMERGE. To move leaf objects, use the NetWare Administrator graphical utility or the NETADMIN text utility. To merge partitions, use the PARTMGR utility.

#### Merging the Source into the Target Tree

When you merge the trees, the servers in the source tree become part of the target tree. (The target tree is the tree that the local tree will be merged into.)

The target [Root] object becomes the new [Root] for objects in the source tree, and the tree name of all servers in the source tree is changed to the target tree name.

After the merge, the target tree name is retained.

The objects that were subordinate to the local [Root] object become subordinate to the target [Root] object.

## Partition Changes

During the merge, all replicas of the root partition are removed from servers in the local tree. The server that contained the master replica of the local tree receives a replica of the target tree's root partition.

During the merge, DSMERGE splits the objects below the local [Root] object into separate partitions.

The following two figures illustrate the effect on partitions when you merge two trees.

Figure 5-1  
Directory Trees Before a Merge

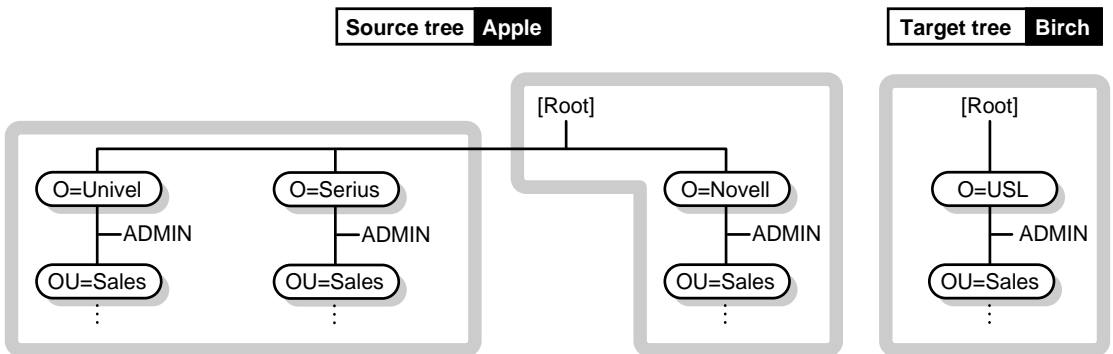
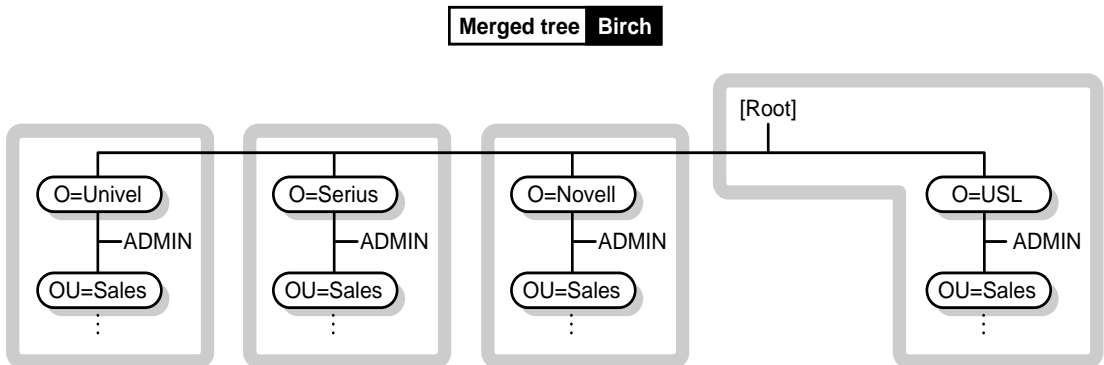


Figure 5-2  
Directory Tree After a Merge



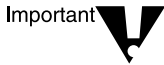
## Preparing the Source and Target Trees

Before performing a merge operation, ensure that the state of synchronization for all servers affected by the operation is stable. The following table provides recommendations for preparing source and target trees for merging.

Necessary Precondition	Required Action
No aliases or leaf objects can exist at the [Root] of the source tree.	Delete any aliases or leaf objects at the [Root] of the source tree.
No similar names can exist between the source and target trees.	Rename objects on the source and target trees if similar names exist.  Move objects from one of the containers to a different container in its tree if you don't want to rename objects. Then delete the empty container before running DSMERGE. (See "Moving Objects in the Directory Tree" on page 68 and "Moving Container Objects Using NETADMIN" on page 76.)  You can have identical container objects in both trees if they are not immediately subordinate to the [Root]. They are uniquely identified by their immediate container object.
No login connections can exist on either the source or target trees.	Close all connections on the source and target trees.
The NDS version must be the same on both source and target tree.	Upgrade all non-4.11 servers that have a replica of the [Root] object.
Any server that contains a replica of the [Root] object on both source and target trees must be up and running.	Ensure that all servers containing a replica of the [Root] partition on both source and target trees are up and running.  Ensure that any WAN links affected are stable.
Schema on both source and target trees must be the same.	Ensure that both source and target trees are time synchronized within 2 seconds of each other.

Because the merge operation is one single transaction, it is not subject to catastrophic failure caused by power outages or hardware failure. However, you should perform a regular backup of the Directory database before using DSMERGE. See Chapter 9, “Backing Up and Restoring Data,” on page 591.

## Time Synchronization before the Merge



Proper configuration of time synchronization is a very involved process. Make sure you allow enough time to synchronize both trees before you merge the trees.

Directory Services will not work properly if two external time sources are used, or if all servers in a tree are not synchronized.

Before you do the merge, make sure that all servers in both trees are synchronized, and use only one time source.

There should be a maximum of one Reference or one Single Reference time server in a tree. Likewise, after the merge, the tree should contain only one Reference or one Single Reference time server.

If each of the trees you are merging has either a Reference or one Single Reference time server, you must reassign one of them to refer to the Reference or Single Reference time server in the other tree so that the final tree contains only one Reference or Single Reference time server (if any).

For more information on time synchronization, see “Monitoring and Maintaining Time Synchronization” on page 262.

To view time synchronization information, see “Checking Time Synchronization (DSMERGE)” on page 342.

## DSMERGE Options

After you load DSMERGE, you can use the following options:



Option	Use to
Check Servers in This Tree	<p>Contact all servers in the local tree to verify that each server has the correct version, status, and tree name.</p> <p>The server you are on must have a replica of the [Root] partition. It does not require the master replica.</p>
Check Time Synchronization	<p>Display a list of all servers in this tree, along with information about time sources and time synchronization.</p> <p>The server you are on must have a replica of the [Root] partition. It does not require the master replica.</p>
Merge Two Trees	<p>Merge the [Root] of the local (source) tree to the [Root] of the target tree.</p> <p>The server you are on must have the master replica of the local tree's [Root] partition.</p>
Rename Tree	<p>Rename the local tree. Use this option if you are merging two roots with the same name.</p> <p>You can rename only the local tree name. To rename the target tree name, load DSMERGE on a server in the target tree. Then load DSMERGE on the source tree to perform the merge.</p> <p>This option requires that the server you are on has the master replica of the [Root] partition.</p>

## Checking Servers in the Tree

Before you rename or merge trees, use this option to contact all servers in the tree and verify that all servers have the same tree name.

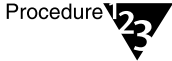
After you rename or merge trees, use this option to verify that all servers have the new tree name.

### Prerequisites



- Access to a server console on the local tree or an established RCONSOLE session with the server
- The Supervisor object right to the [Root] object of the local tree

### Procedure



1. **Load DSMERGE on the server where a replica of the [Root] partition of the local tree is stored.**

At the server console prompt, type

```
LOAD DSMERGE <Enter>
```

2. **Choose “Check servers in this tree.”**

Each server in the tree is listed in the “Status of Servers in the Tree” screen., with their corresponding status information. Any servers that have existing problems are flagged and then listed at the top of the server list.

You should confirm that each server’s status is marked as “Verified” before completing a merge of two trees.

The following table describes the information provided in the “Status of Servers in the Tree” screen.

Field	Operation
Server Name	Lists the names of all servers DSMERGE contacted, and shows their context within the tree.
Version	Indicates the version of NetWare running on the server.
Status	<ul style="list-style-type: none"><li>◆ UP</li></ul> <p>Indicates that the server is in the right tree.</p> <ul style="list-style-type: none"><li>◆ Error <i>number</i></li></ul> <p>All Directory Services errors are numbered between –600 and –699 in decimal notation.</p> <p>See <i>System Messages</i> for an explanation of specific Directory Services error messages.</p> <ul style="list-style-type: none"><li>◆ Unknown</li></ul> <p>Indicates the server is not responding. This is usually the cause of a downed server or of communication problems.</p> <ul style="list-style-type: none"><li>◆ Wrong Tree</li></ul> <p>Indicates that this server does not belong to this Directory tree.</p> <p>This status might occur if the tree was recently merged or renamed because the server might take a few minutes to recognize the change.</p> <p>Or, this status can occur if the server was reinstalled in another tree, but not properly removed from this tree. If so, delete this server’s object from this tree.</p>

## Checking Time Synchronization (DSMERGE)

Use this procedure on both of the trees before merging them.

### Prerequisites

Checklist



- Access to a server console on both the source and target trees or an established RCONSOLE session with the servers
- The Supervisor object right to the [Root] object of both the source and target trees

### Procedure

Procedure



1. **Load DSMERGE on the server where a replica of the [Root] partition of the local tree is stored that has the master replica.**

At the server console prompt, type

```
LOAD DSMERGE <Enter>
```

If you don't know where the master replica is, load DSMERGE on any server. You will be prompted with the name of the server that contains the master replica when it is required.

2. **Choose “Check time synchronization.”**

The “Time Synchronization Information for Tree *treename*” screen appears.

This option displays a list of all servers in the tree, along with information about their time sources and the server time.

Verify that all servers in the tree are synchronized and that they are using the same time source.

The following table describes the information provided in the “Time Synchronization Information for Tree *treeName*” screen.

Field	Operation
Server Name	Lists the name of each server recorded in the tree’s [Root] partition. If the server could not be contacted, it is listed as “Unknown.”
Type	Indicates the kind of time server the server is using.
In Sync	<ul style="list-style-type: none"><li>◆ YES</li></ul> Indicates that the server is in sync with the time server.
	<ul style="list-style-type: none"><li>◆ NO</li></ul> Indicates that the server is not in sync with the time server.
	This option does not indicate if the local server is in sync with the server you have selected. Check the type of time server each server is using to determine if they are using different time servers.
Time Delta	Displays the difference in time between the local server and the selected server in the list.
	If the difference in time is more than a few minutes, it may indicate that the servers are using different time servers.

## Merging Two Trees

For complete functionality of all menu options in DSMERGE, load DSMERGE on a server that contains the master replica.

If you don’t know where the master replica is stored, you will be prompted with the correct server name when you attempt an operation that requires the master replica.

To perform a merge operation, you must load DSMERGE on the local tree.

When merging large trees, it’s significantly faster to designate the source tree as the tree with fewer objects immediately subordinate to

the [Root]. By doing this, you create fewer partition splits during the merge, since all target tree objects result in new partitions.



Because the local tree name no longer exists after the merge, you must update the “PREFERRED TREE” statement in the NET.CFG files of all local client workstations.

To minimize the number of client workstations you need to update, designate the tree with the most client workstations as the target tree, because the final tree retains the name of the target tree.

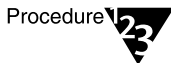
Or, rename the tree after the merge operation so that the final tree name corresponds to the tree with the greater number of client workstations attaching to it. See “Renaming the Tree” on page 345.

### Prerequisites



- Access to the server console on the local tree or an established RCONSOLE session with that server
- The Supervisor object right to the [Root] object of both trees you want to merge
- A regular backup of the Directory Services database for the two trees
- All servers in both trees are synchronized and using the same time source
- (Optional) All servers in the tree are verified

### Procedure



1. **Load DSMERGE on the server where the master replica on the local tree is stored.**

At the server console prompt, type

```
LOAD DSMERGE <Enter>
```

If you don't know where the master replica is stored, you will be prompted with the correct server name when you attempt to merge the trees.

2. **Choose “Merge two trees.”**

The “Merge Tree Information” screen appears.

- 3. Enter the administrator name and password to log in to the local (source) tree.**

Log in as a user who has the Supervisor object right to the [Root] object on the local tree. Enter the typeless or typeful Distinguished Name, such as ADMIN.NOVELL or CN=ADMIN.O=NOVELL. Entering only ADMIN is invalid because it is not the complete name of the User object.

- 4. Choose “Target Tree” and select a target tree from the list servers in the “Available Trees” window.**

If the tree you want is not in the list, press <Insert> and enter the target tree’s network address.

- 5. Enter the administrator name and password to log in to the target tree.**

- 6. Press <F10> to perform the merge.**

A message stating that the trees have been merged successfully is displayed.

## Renaming the Tree

You must rename a tree if the two trees you want to merge have the same name.

You can rename only the local (source) tree name. To rename the target tree, run DSMERGE from a server on the target tree.

After you change a tree’s name, you must update the clients’ “PREFERRED TREE” statement in their NET.CFG files.

When you merge two trees, to minimize the number of client workstations that need to be updated, designate the tree with the most client workstations as the target tree because the final tree retains the name of the target tree.

Or, rename the tree after the merge so that the final tree name corresponds to the tree name with the majority of client workstations.

Another option is to rename the merged tree to the name of the original source tree. If you choose this option, then you must update the NET.CFG files on the target tree client workstations.

### Prerequisites



- Access to a server console on the local tree or an established RCONSOLE session with the server
- The Supervisor object right to the [Root] object of the local tree
- (Optional) All servers in the tree are verified

### Procedure



1. **Load DSMERGE on the server where a master replica of the [Root] partition is stored.**

At the server console prompt, type

```
LOAD DSMERGE <Enter>
```

If you don't know where the master replica is, load DSMERGE on any server in the local tree. Then you will be prompted with the correct server name when you attempt to rename a tree.

2. **Choose "Rename this tree."**
3. **Enter the administrator name and password to log in to the local (source) tree.**

Log in as a user who has the Supervisor object right to the [Root] object on the local tree. Enter your complete name, such as ADMIN.NOVELL or CN=ADMIN.O=NOVELL. Entering only ADMIN is invalid since it is not a complete name.

4. **Enter the new tree name.**
5. **Press <F10> to perform the rename.**

## Completing the Tree Merge

Following the merging of two trees, it might be necessary to complete the following tasks:



1. (Optional) Choose “Checking Servers in the Tree” in the DSMERGE main menu to confirm that all tree names were changed correctly. See “Checking Servers in the Tree” on page 340.
2. Check the new partitions that the merge operation created. If you have many small partitions in the new tree, or if you have partitions that contain related information, you might want to merge them. See “Merging Partitions” on page 301.
3. Copy a new replica to any non-NetWare 4.11 servers after the merge is complete, if you did not upgrade before running DSMERGE.
4. Re-create any leaf objects or aliases at the [Root] that were deleted before you run DSMERGE.
5. Evaluate partitioning of the Directory tree.

Merging trees might significantly change replica placement on the source tree. You should carefully evaluate and change the partitioning as needed.

6. Update client workstations’ “PREFERRED TREE” statements in their NET.CFG files or rename the target tree.

Only the target tree name is retained after the merge.



To minimize the number of NET.CFG files you need to update, designate the tree with the most client workstations as the target tree because the final tree retains the name of the target tree.

Or, rename the tree after the merge operation so that the final tree name corresponds to the majority of the client workstations’ NET.CFG files. See “Renaming the Tree” on page 345.

The target [Root] object becomes the new [Root] for servers moved from the source tree. The Access Control List (ACL) for the [Root] object of the source tree are preserved. Therefore, the rights of the source tree’s user ADMIN to the [Root] object are still valid.

After the merge is complete, both ADMIN users still exist and are uniquely identified by different container objects.



For security reasons, you might want to delete one of the two ADMIN User objects or restrict the rights of the two objects.

For more information about	See
Object and property rights	“Object Rights” on page 11 and “Property Rights” on page 12
Partitions and replicas	“Creating and Managing Directory Services Partitions” on page 296
[Root] object	“Naming Your Directory Tree” in Chapter 3 of <i>Guide To NetWare 4 Networks</i>  “Root object,” “Directory tree,” and “Objects” in <i>Concepts</i>
Time synchronization	“Monitoring and Maintaining Time Synchronization” on page 262
DSMERGE	“DSMERGE” in <i>Utilities Reference</i>

## Viewing and Managing NDS Synchronization Status

This section explains the NDS Trace feature that you can use from the server console. You should use this feature:

- ◆ To determine whether NDS synchronization processes are complete.
- ◆ To diagnose NDS errors. These errors may appear when you are manipulating NDS objects with the administration utilities. NDS errors also show up on the NDS Trace screen.

You can identify NDS-related system messages by their numbering: -601 through -699 and F966 through F9FE.



As with all NetWare system messages, an NDS system message does not necessarily indicate an error condition, but may simply indicate general NDS status. For more information, see the specific message in *System Messages*.

### Prerequisites



- Access to the server console, or an established RCONSOLE session with the server



## Procedure

1. **Turn on the NDS Trace screen by typing the following at the server console:**

```
SET NDS TRACE TO SCREEN = ON <Enter>
```

2. **(Optional) To copy NDS Trace messages to a file, type**

```
SET NDS TRACE TO FILE = ON <Enter>
```

By default, the messages are copied to the file DSTRACE.DBG in the SYS:SYSTEM directory.

To copy the messages to a different directory and/or file on volume SYS:, type

```
SET NDS TRACE FILENAME = path\filename <Enter>
```



Copying NDS Trace messages to a file may be helpful if you need to ask someone else for diagnostic help.

3. **To view NDS Trace screen messages, press <Alt>+<Esc> until you see the “Directory Services” screen.**

Two types of messages are of particular interest:

- ◆ “All processed = YES” indicates that all pending NDS synchronization actions have been processed.
- ◆ Messages numbered -601 through -699 and F966 through F9FE indicate NDS status or errors. For explanations and suggested actions, see *System Messages*.

4. **To disable tracing, type**

```
SET NDS TRACE TO SCREEN = OFF <Enter>
```

---

<b>For more information about</b>	<b>See</b>
NDS Trace options	“Novell Directory Services Parameters” under SET in <i>Utilities Reference</i>
NDS system messages	<i>System Messages</i>

---

## ***Migrating Data Using the High Capacity Storage System***

### **What is the High Capacity Storage System?**

The High Capacity Storage System (HCSS) is a utility that extends the storage capacity of a NetWare<sup>®</sup> server by integrating an optical disk library, or jukebox, into the NetWare file system.

HCSS moves files between the server's faster, but limited-capacity, storage devices (hard disks) and the slower, high-capacity storage devices (magneto-optical disks) in a jukebox.

This process, called data migration and demigration, is mostly hidden from the end user.

HCSS uses a NetWare volume to cache frequently used files, and manages the migration of less frequently used files to media in a jukebox.

Once a jukebox and the HCSS directories are set up, users and applications can access files stored on media by using the same NetWare commands and function calls with which they access files stored on the volume.

After the initial configuration, you can use HCSS in the NetWare Administrator graphical utility to

- ◆ Import and export media
- ◆ Format and reformat media
- ◆ Delete HCSS directories
- ◆ Change HCSS file storage parameters

HCSS also gives you the flexibility to physically transport directory and file data. You can move media to another jukebox, or you can store media on a shelf for archiving.

## HCSS Concepts

To understand the information in this chapter, you should be familiar with the following entries in *Concepts*:

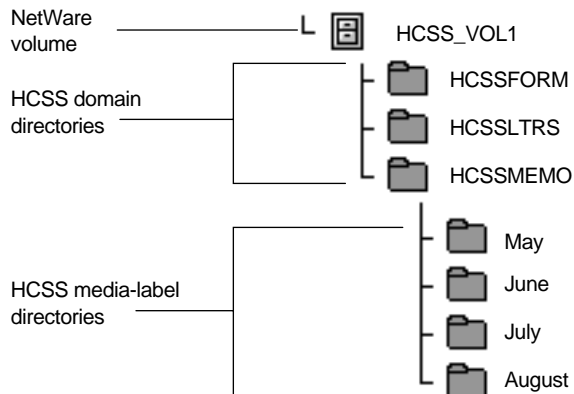
- “Data migration”
- “High Capacity Storage System”
- “Jukebox”

## How the HCSS File System Is Structured

An HCSS directory looks like other directories in the NetWare file system. However, certain levels in an HCSS directory are created and handled differently.

Figure 6-1 illustrates these levels in a NetWare file system structure.

**Figure 6-1**  
**Sample HCSS File**  
**System Structure**



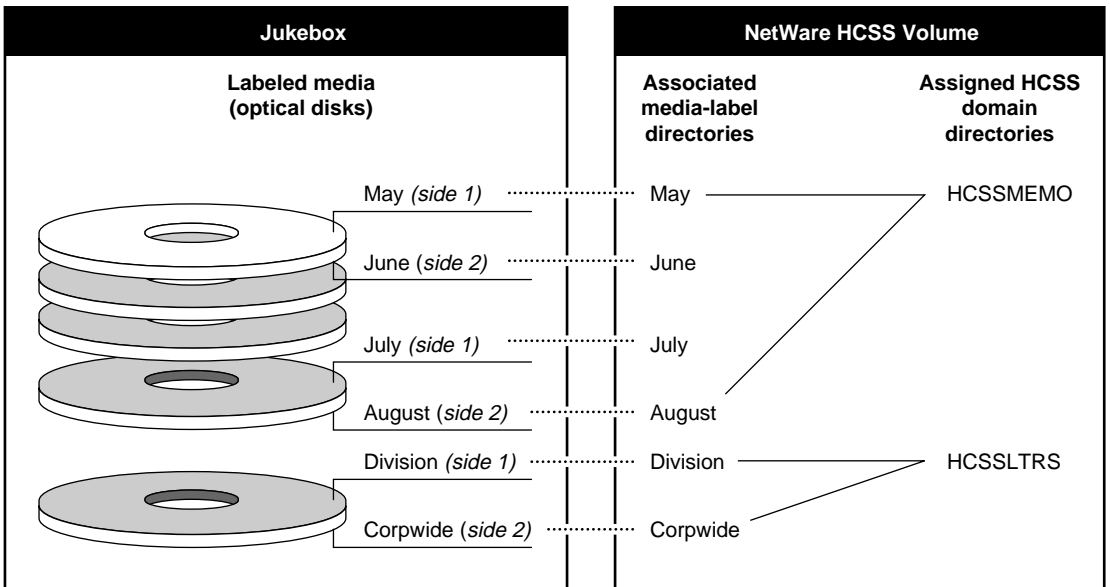
You create HCSS domain directories off the root of an HCSS volume. Within these directories, you create pairs of media-label directories. Each media-label directory corresponds to one side of media (that is, to one side of magneto-optical media that is labeled “Formatted Rewriteable Optical Disk”).



Creating HCSS directories and non-HCSS directories on the same volume can cause problems for HCSS users. Non-HCSS directories can fill the volume to its migration threshold and trigger migration inefficiently.

Figure 6-2 illustrates the association between media in the jukebox and media-label directories in the HCSS volume on the server.

**Figure 6-2**  
**Labeled Media and Related Directories**



An HCSS volume can contain an unlimited number of HCSS domain directories, and each domain directory can have several media-label directories (in multiples of two only, one media-label directory for every side of media assigned to that domain directory).

Each media-label directory can have multiple levels of subdirectories and files, like any other NetWare directory.

You are limited, however, to only one HCSS volume per NetWare server and to two media-label directories for each piece of media (that is, two for each optical disk) your jukebox will hold.



Although it is possible for HCSS domain directories and non-HCSS directories (regular NetWare directories) to coexist on the same volume, for management

simplicity, we recommend you create and dedicate one volume exclusively for HCSS domain directories and their contents.

## What Happens When Data Migrates

A file is considered migrated when the file data (everything inside of the file) has been moved from the volume to the corresponding labeled side of media in the jukebox.

File information, such as the file name and file size, remains on the volume so you can view the complete directory structure and access a file at any time.

The space the file data occupied on the NetWare volume is available after the file data has migrated, thus allowing more data to be stored in the volume. A 100MB volume, for example, has the potential to store many gigabytes as some of its files migrate to the jukebox.

The triggers that start and stop migration are the upper and lower threshold parameters, which are set with HCSS commands.

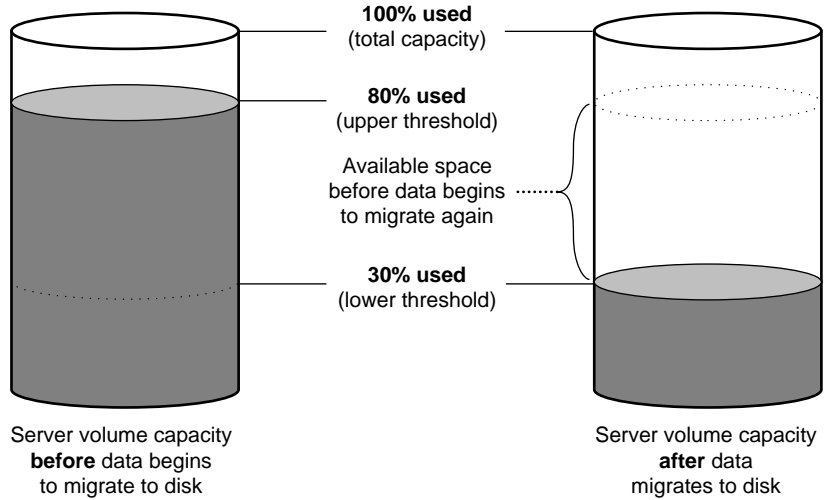
The least-recently-used file data migrates when the upper volume-capacity threshold is reached or at a set time of day, and migration continues until the lower volume-capacity threshold is reached.

Figure 6-3 illustrates the upper and lower threshold concept. Assume that this is a 100MB volume and that its upper threshold is set to 80 percent and its lower threshold to 30 percent.

When 80 MB of the volume contain data, the oldest file data begins to migrate to the jukebox. The data continues to migrate until only 30 MB of data remain on the volume, making 50 MB of space on the volume available for more file data.



**Figure 6-3**  
**Volume Capacity**  
**Before and After**  
**Data Migration**



This migration process might happen several times a day, depending on the size of the volume.

Migration occurs on a file-by-file basis according to the last time a file was accessed (least-recently-used files migrate first).

The migration process doesn't allow file data to flow from one side of media to the other. If one side of media is nearly full, you are notified so you can decide whether to delete or move files.



Note

For information on how to determine if a file has been migrated, see "NDIR" or "FLAG" in *Utilities Reference*.

Migrated file data stays on the media until the file is accessed; then the file data is automatically demigrated to the volume. Migrated files are always available, but file access may be slower.

## Media Access Control

HCSS has options you can adjust to provide fair and efficient access to media in the jukebox. These options allow you to specify the amount of time a side of media is loaded in the jukebox drive to fill requests before the changer switches to another side of media.

The way HCSS controls media access is called elevator queuing. Elevator queuing for a jukebox works like an elevator in a tall building. Requests for any given floor come in sporadically. Rather than filling the requests in a first-come-first-served order, the elevator system determines the most efficient way to fill every request.

The number of people who can get on or off the elevator on any floor is determined by how long the doors remain open on a floor. If the elevator doors are closing and a person in the hallway pushes the elevator button, the doors will open again for a given period.

Likewise with HCSS, all requests for a side of media are queued by the system. Once the side of media is loaded into the drive, the system tries to fill as many requests as possible within a given time limit.

## **Media Export and Import Operations**

HCSS can export (remove) media from the jukebox and later import (load) it into the same jukebox or into a different jukebox on another server with HCSS installed.

Before exporting a piece of media, HCSS attempts to migrate all file data under the two affected media-label directories to the media.

If all file data is migrated, the media, complete with the two media-label directories and files, is ejected from the jukebox and all references to the two directories are deleted from the volume.

When media is imported and assigned to an HCSS domain directory, the two media-label directories (including all subdirectories, files, and file attributes) are re-created in the domain directory just as they were before the media was exported.

## Restrictions

The following restrictions apply when you use HCSS.

- ◆ Supports only one volume per server.

Only one NetWare volume on the server where HCSS is installed can have the migration attribute set.



Do not have more than one volume with the migration attribute set on the server where HCSS is installed. This would compromise migration and may cause migration to fail.

- ◆ Supports only one jukebox per server.
- ◆ Supports only the DOS name space.
- ◆ Requires a Windows\* 3.x or Windows 95\* client.
- ◆ Requires use of NetWare Administrator to delete media-label and domain directories.

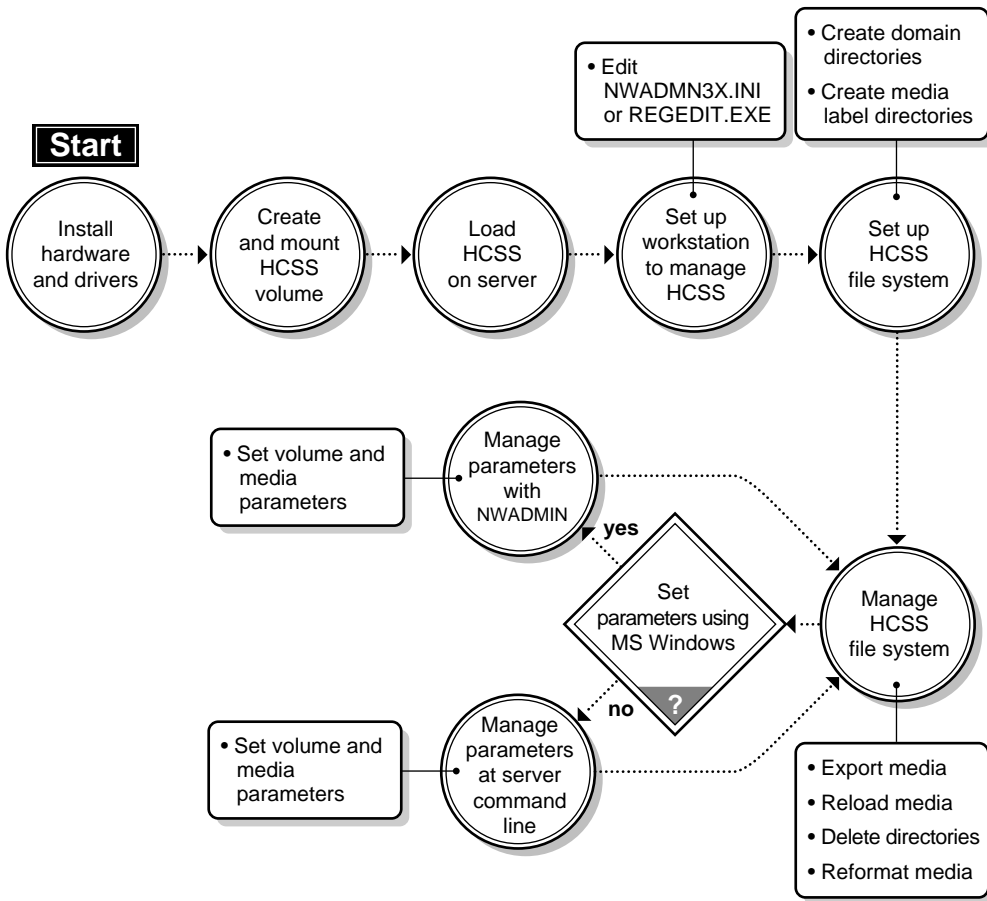
You can delete HCSS domain directories and media-label directories only by using the HCSS tools in the NetWare Administrator graphical utility.

- ◆ Doesn't support modifying media label and domain directory attributes.
- ◆ Doesn't support renaming of any subdirectory under a media-label directory.

# Overview of HCSS Setup and Management

Figure 6-4 illustrates the tasks required to integrate HCSS with your regular NetWare® file system.

Figure 6-4  
HCSS Tasks



## How the HCSS File System Is Managed

After you install HCSS on the server, you can use the NetWare Administrator graphical utility at a workstation to perform all routine file system management tasks.

Table 6-1 summarizes how you must create, set up, and manage the levels of the HCSS directory structure.



Do not use other NetWare utilities to manage HCSS domain directories or media-label directories. Doing so could cause your file system to become corrupted.

**Table 6-1**  
**Managing the HCSS File System**

File System Level	Management Method
HCSS volume	<p>Use the NetWare INSTALL module to create and modify volumes.</p> <p>Use HCSS commands either in NetWare Administrator or at the server console prompt (MSEngine prompt if you are running SFT III) to set data migration parameters for the volume.</p> <p>Requires Supervisor right, or equivalent, in the file system.</p>
HCSS domain directory on the volume	<p>Use HCSS commands in NetWare Administrator to create and manage HCSS domain directories.</p> <p>Requires Supervisor right, or equivalent, in the file system.</p>
HCSS media-label directory	<p>Use HCSS commands in NetWare Administrator to create and modify media-label directories.</p> <p>Requires Supervisor right, or equivalent, in the file system.</p>
Subdirectories below media-label directory	<p>Create and modify by using standard NetWare utilities and commands.</p> <p>Users with appropriate rights can work at this level the same as they do in the regular NetWare file system.</p>

## Additional Information

For more information about	See
Creating HCSS volumes	“Creating an HCSS Volume” on page 362 “Manage NetWare Volumes” in Chapter 3 of <i>Installation</i>
HCSS functionality	“High Capacity Storage System” and “Data migration” in <i>Concepts</i>
HCSS system messages	<i>System Messages</i>

## Installing and Setting Up HCSS

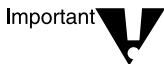
This section describes how to install a new High Capacity Storage System (HCSS) utility under the NetWare 4.11 operating system.

If you already have HCSS running under NetWare 4.1, you can use your existing HCSS utility with NetWare 4.11. However, to run HCSS under the new version of NetWare Administrator that comes with NetWare 4.11, you must update the NWADMN3X.INI file with three new DLL names. See “Setting Up a Windows 3.x Workstation to Manage HCSS” on page 365.

## Installing Hardware

The NetWare 4.11 release of HCSS requires the following:

- ◆ Hewlett Packard 1718, 1715, or 1710 SCSI jukeboxes, or compatible jukeboxes using either the SCSICHGR.CDM driver or the HPCHGR.DSK driver. Both drivers support media of 512 and 1,024 bytes per sector



If your adapter uses a .HAM driver, then use the SCSICHGR.CDM jukebox driver. If your adapter uses a .DSK driver, then use the HPCHGR.DSK jukebox driver. You cannot mix .DSK and .HAM drivers. The following procedure, “Loading HCSS Drivers” on page 361, explains which jukebox driver to use with which adapter.

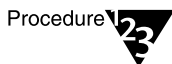
- ◆ Magneto-optical media that have been low-level formatted (labeled “Formatted Rewriteable Optical Disk” by the manufacturer)

- ◆ A workstation running Windows 3.x or Windows 95

Install the jukebox and its adapter according to the documentation that came with the products.

## Loading HCSS Drivers

### Procedure



- 1. Ensure that the appropriate hardware has been installed as recommended by the hardware manufacturer.**

- 2. Load the applicable drivers.**

- 2a. Load the adapter driver(s).**

At the server console prompt (or IOEngine prompt on an SFT III system), load the correct .HAM or .DSK driver(s) for your board.

For example, if your board is the Adaptec 1540, you would type

```
LOAD SCSI154X.HAM <Enter>
```

If your board is the DPT 2022, you would type

```
LOAD PM12NW40.DSK <Enter>
```

```
LOAD DPTSIM4.DSK <Enter>
```

Some adapter drivers require you to specify parameters or options. For more information, see the hardware manufacturer's documentation.

- 2b. If you loaded a .DSK adapter driver, then load ASPITRAN.DSK.**

At the server console prompt (or IOEngine prompt on an SFT III system), type

```
LOAD ASPITRAN.DSK <Enter>
```

Some adapter drivers might autoloading ASPITRAN.DSK.

- 2c. If you loaded a .HAM adapter driver, then load the magneto-optical device driver.**

At the server console prompt (or the MSEngine prompt on an SFT III system), type

```
LOAD SCSIMO.CDM <Enter>
```

You need to load the driver only once, even if there are multiple drives in the jukebox.

**2d. Load the jukebox driver.**

At the server console prompt (or the MSEngine prompt on an SFT III system), load the correct jukebox driver for your adapter driver.

If you loaded a .HAM adapter driver, type

```
LOAD SCSICHGR.CDM <Enter>
```

If you loaded a .DSK adapter driver, type

```
LOAD HPCHGR.DSK <Enter>
```

**3. Type the following at the server console prompt (or MSEngine prompt on an SFT III system):**

```
LIST DEVICES <Enter>
```

The LIST DEVICES command checks for peripheral devices added since the server was last booted and then registers the added devices with the operating system.

## Creating an HCSS Volume

An HCSS volume *must* be in the Novell® Directory Services™ database, and the HCSS volume *must not* be in the SYS: volume.



To simplify management of your HCSS system, we recommend that you create a dedicated HCSS volume for your domain directories and their contents. Make the HCSS volume capacity at least 10 percent of the full capacity of the jukebox. Consider adding hard disk space or moving existing directories if necessary. You should provide enough room for frequently accessed files, or access time may be slower due to file migration and demigration.

An HCSS volume is created like any other NetWare volume, but it requires some specific settings.



Create an HCSS volume using the procedure detailed in “Creating Volumes” on page 469, but, before mounting it, do the following:

- ◆ Choose the volume and set the following parameters:

File Compression: OFF or ON (as appropriate)

Block Suballocation: OFF or ON (as appropriate)

Data Migration: ON

To change any of these parameters, select the parameter and press <Enter> to toggle between off and on.

- ◆ Choose the volume and set the volume block size, using one of these supported settings, to match your average file size:

Settings: 4 KB, 8 KB, 16 KB, 32 KB, or 64 KB

If Block Suballocation is ON, set “Volume Block Size” to 64 KB.

- ◆ Save all changes

## Loading HCSS on the Server



### Prerequisites

- Jukebox and adapter installed according to the hardware manufacturer’s instructions
- HCSS drivers loaded, and LIST DEVICES executed (see “Loading HCSS Drivers” on page 361)
- HCSS volume created and mounted

## Procedure



1. **At the server console prompt (or the MSEngine prompt on an SFT III system), type**

```
LOAD HCSS <Enter>
```

The HCSS module, as well as several other loadable modules, autoloads RTDM.NLM (a module that enables migration).

When HCSS is loaded, it takes inventory of the media in the jukebox and verifies a correlation between the media-label directories (directories created when importing media) and the media. Any media without corresponding media-label directories are ejected.

When HCSS has completed the inventory and verification, the message “HCSS is up and running” appears on the server (or MSEngine) console and is broadcast to user ADMIN or equivalent. (The message doesn’t appear when HCSS is loaded for the first time.)



When HCSS is loaded for the first time, it will not be fully functional until you have created the domain and media-label directories. How to create these directories is explained in “Setting Up the HCSS File System” on page 369.

2. **(Conditional) If the jukebox ejects media when you load HCSS, remove the media and, at the server console prompt (or the MSEngine prompt), type the following:**

```
MEDIA REMOVED <Enter>
```

Enter this command after each piece of media is removed.



You can prevent more media from being ejected by typing the following command at the server (or MSEngine) console: HCSS Eject Media Override=On. See “Setting Parameters at the Server Console” on page 397.

3. **(Optional) Add the commands to load the drivers and loadable modules to the server's AUTOEXEC.NCF file (or to the MEngine's MSAUTO.NCF file on an SFT III system).**

Adding the commands to the file allows the drivers and modules to be loaded automatically every time the server is restarted.

For more information about adding commands to the .NCF file, see "Creating or Editing a Server Batch (.NCF) File" on page 416.



Two .NCF files are included in the HCSS module for unloading and reloading HCSS when needed. Run HUNLOAD.NCF if it becomes necessary to unload HCSS. Run HRELOAD.NCF to reload (reinitialize and set up) HCSS after a fatal error has occurred.

If you are running SFT III and the server to which the jukebox is attached fails, you must run HRELOAD.NCF after the mirrored servers resynchronize.

4. **At each workstation you plan to use to manage HCSS, edit the NWADMN3X.INI file as described in "Setting Up a Windows 3.x Workstation to Manage HCSS," or edit the system registry as described in "Setting Up a Windows 95 Workstation to Manage HCSS" on page 367.**

## Setting Up a Windows 3.x Workstation to Manage HCSS

Many HCSS management tasks can be done only through NetWare Administrator, which runs under Windows 3.x or Windows 95. You must configure NetWare Administrator to display the HCSS options in the "Tools" menu.

If you are using Windows 95, see the next section, "Setting Up a Windows 95 Workstation to Manage HCSS" on page 367.

If you are using Windows 3.x, complete the following procedure. For more information about the NWADMN3X.INI file, see *NetWare Client for DOS and Windows User Guide*.

Checklist



### Prerequisites

- HCSS hardware and server software installed
- A volume created and set up for the HCSS file system
- NetWare Administrator run once to create the NWADMN3X.INI file entries

Procedure



### Procedure

1. **At the workstation you plan to use to manage HCSS, log in as ADMIN, or equivalent, to the server where HCSS is loaded.**

2. **At the same workstation, change to the MS Windows directory where the NWADMN3X.INI file is stored.**

If you can't locate the NWADMN3X.INI file, verify that you have successfully loaded NetWare Administrator in your MS Windows directory.

For more information, see *NetWare Client for DOS and Windows User Guide*.

3. **Using a text editor, open the NWADMN3X.INI file and add the following lines under the [Snapin Object DLLs WIN 3X] section heading:**

```
HCSSDecider = HDECSN3X.DLL
HCSSObject = HOBJSN3X.DLL
HCSSMedia = HMEDSN3X.DLL
```

4. **Save your changes and exit the NWADMN3X.INI file.**
5. **Create HCSS directories, as described under "Setting Up the HCSS File System" on page 369.**

## Setting Up a Windows 95 Workstation to Manage HCSS

Many HCSS management tasks can be done only through NetWare Administrator, which runs under Windows 3.x or Windows 95. You must configure NetWare Administrator to display the HCSS options in the “Tools” menu.

If you are using Windows 3.x, see the previous section, “Setting Up a Windows 3.x Workstation to Manage HCSS” on page 365.

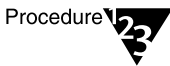
If you are using Windows 95, complete the following procedure. For more information about the Windows 95 system registry and keys, see the online Help in NetWare Administrator.

### Prerequisites



- HCSS hardware and server software installed
- A volume created and set up for the HCSS file system
- NetWare Administrator run once to create the NetWare Administrator object in the system registry

### Procedure



1. **At the workstation, log in to the server where HCSS is loaded.**
2. **Click the “Start” button, then choose “Run.”**
3. **In the dialog box, type the following:**

```
REGEDIT <Enter>
```

The Registry Editor window is displayed.

4. **Double-click the following folders, in sequence:**

HKEY\_CURRENT\_USER

Software

NetWare

Parameters

NetWare Administrator

5. **Highlight the “Snapin Object DLLs Win95” key and create three new Values, as follows.**
  - 5a. **From the menu bar, choose “Edit,” then “New,” then “String Value.”**

A new Value is displayed in the “Name” column, with the default name “New Value #1.”
  - 5b. **In place of the default name, type the following and then press <Enter> twice:**

`HCSSDecider`

The “Edit String” dialog box is displayed.
  - 5c. **In the “Value Data” field, type**

`HDECSN95.DLL`
  - 5d. **Click “OK.”**

The Value data now appears in the “Data” column.
  - 5e. **Repeat Step 5a and Step 5b to create the second Value. Type the Value name as**

`HCSSObject`
  - 5f. **Repeat Step 5c and Step 5d to enter the Value data. Type the Value data as**

`HOBJSN95.DLL`
  - 5g. **Repeat Step 5a and Step 5b to create the third Value. Type the Value name as**

`HCSSMedia`
  - 5h. **Repeat Step 5c and Step 5d to enter the Value data. Type the Value data as**

`HMEDSN95.DLL`
6. **From the menu bar, choose “Registry,” then “Exit.”**

## Setting Up the HCSS File System

To set up your HCSS file system:

1. Create one or more HCSS domain directories off the root of the HCSS volume. (See “Creating an HCSS Domain Directory” on page 369.)
2. Create media-label directories immediately below each domain directory. (See “Creating HCSS Media-Label Directories” on page 371.)



Hint

Because the domain directory and the media-label directory must be managed with HCSS commands, you might want to give them distinctive names to distinguish them from other NetWare directories.

### Creating an HCSS Domain Directory

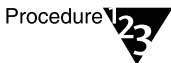
#### Prerequisites



Checklist

- A workstation running NetWare Administrator
- HCSS hardware and server software installed
- A volume created and set up for the HCSS file system
- You are logged in as ADMIN, or equivalent, to the server on which HCSS is loaded

#### Procedure



Procedure

1. **Start NetWare Administrator.**
2. **From the browser, select the HCSS volume where you want to create the HCSS domain directory.**

For information about moving around in the browser and selecting objects, choose “Help” from the menu bar and look up “Navigation.”

3. Verify that HCSS options appear in the “Tools” menu.

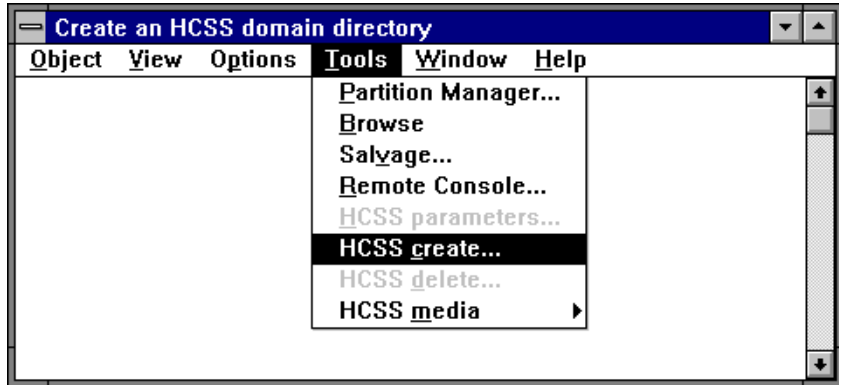
The options include “HCSS Parameters” and “HCSS Create.”

If the HCSS options do not appear in the “Tools” menu, verify that you have met the prerequisites listed for this procedure.

4. From the “Tools” menu, select “HCSS Create.”

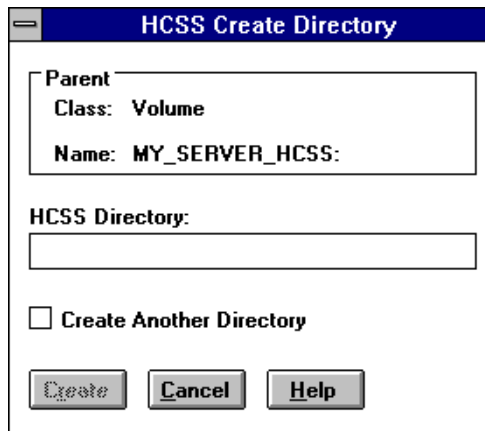
(See Figure 6-5.)

Figure 6-5  
Selecting the  
“HCSS Create”  
Option



The “HCSS Create Directory” dialog box appears. (See the example in Figure 6-6).

Figure 6-6  
“HCSS Create  
Directory” Dialog  
Box





**5. Complete the “HCSS Create Directory” dialog.**

**5a. In the “HCSS Directory” text box, type a unique name for the HCSS domain directory.**

The name can be no longer than eight characters, with no extension. Allowable characters are: uppercase A–Z and 0–9.

**5b. (Optional) If you want to create more than one HCSS domain directory, select “Create Another Directory.”**

**5c. Choose “Create.”**

If you selected “Create Another Directory,” the dialog box remains on the screen so you can type in your next directory name.

If you did not select (or have unselected) “Create Another Directory,” you are returned to the browser, where the name or names of the new HCSS directories appear under the HCSS volume.

You can now create HCSS media-label directories, as described in the following section.

## Creating HCSS Media-Label Directories

Checklist



### Prerequisites

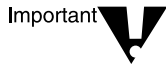
- A workstation running NetWare Administrator
- HCSS hardware and server software installed
- A volume created and set up for the HCSS file system
- Domain directories created
- You are logged in as ADMIN, or equivalent, to the server on which HCSS is loaded

You create media-label directories when you assign labeled media to a domain directory.

To label or assign new or existing media, use the following table and determine which procedures to follow.

If you need to	Complete these procedures
Load new media (or media that you intend to overwrite) into the jukebox and file system	<ol style="list-style-type: none"><li>1. "Importing Media" on page 372</li><li>2. "Formatting Media" on page 375</li><li>3. "Assigning HCSS Media to Domain Directories" on page 377</li></ol>
Import previously formatted media, with files and directories intact, into the jukebox and file system	<ol style="list-style-type: none"><li>1. "Importing Media" on page 372</li><li>2. "Assigning HCSS Media to Domain Directories" on page 377</li></ol>

For an example of assigned media, see Figure 6-2.



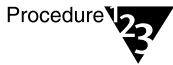
Always use the "HCSS Import" option to load media; don't load it into the jukebox manually.

## Importing Media



During the import process, access to migrated data on other media is denied.

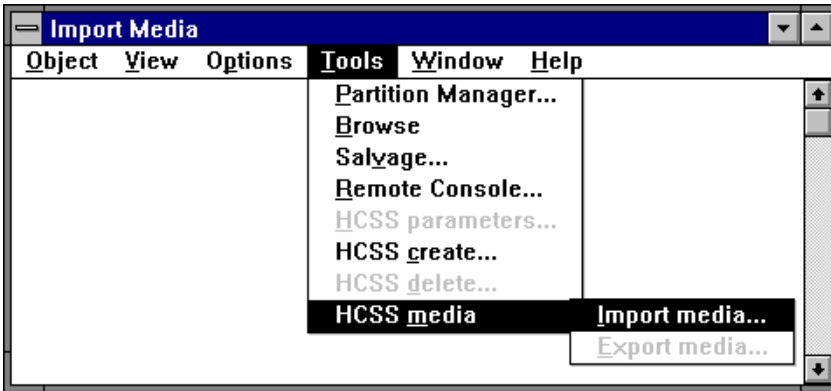
### Procedure



1. **Start NetWare Administrator.**
2. **From the browser, choose an HCSS domain directory.**
3. **From the "Tools" menu, select "HCSS Media."**

(See Figure 6-7.)

Figure 6-7  
Selecting the “Import Media” Option



**4. From the “HCSS Media” menu, select “Import Media.”**

The “HCSS Import Media” dialog box appears, prompting you to insert the media.



Hint

Before inserting media, label the cartridges with the names of the two media-label directories you plan to create.

**5. Insert the media into the jukebox’s mail slot.**



Important

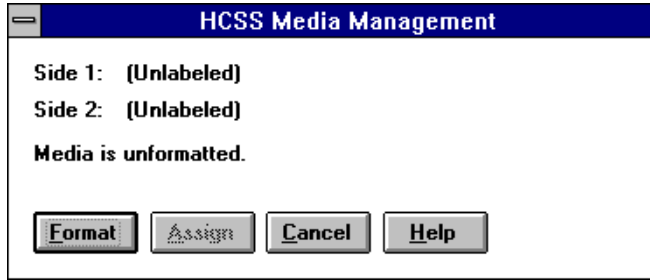
Use only media labeled by the manufacturer “Formatted Rewriteable Optical Disk.” This is a low-level format done by the manufacturer.

**6. Choose “OK.”**

The “HCSS Media Management” dialog box (Figure 6-8) appears, displaying the state of the media that was loaded (either “Media is unformatted” or “Media is formatted and unassigned”).

In this case, “formatted” refers to the high-level format that must be done by HCSS before the media can be used for data migration.

**Figure 6-8**  
**“HCSS Media**  
**Management”**  
**Dialog Box**



If the media is unformatted, you must format it before proceeding.

**7. Choose a command from the dialog box and then go to the appropriate procedures, as shown in the following table:**

<b>If you need to</b>	<b>Choose</b>	<b>Then go to</b>
Format or reformat media (when media is new or you plan to overwrite existing contents)	Format	“Formatting Media” on page 375
Create HCSS media-label directories by assigning media to an HCSS domain directory	Assign	“Assigning HCSS Media to Domain Directories” on page 377
Eject media from the jukebox	Cancel	Step 5 if you want to import media, or continue to select “Cancel” to return to the browser

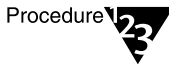
## Formatting Media

Before files can be stored on media, the media must be high-level formatted by HCSS.



### Prerequisites

- HCSS hardware and server software installed
- A volume created and set up for the HCSS file system
- Domain directories created
- You are logged in as ADMIN, or equivalent, to the server on which HCSS is loaded
- A workstation running NetWare Administrator
- Magneto-optical media imported into the jukebox (see “Importing Media” on page 372)



### Procedure

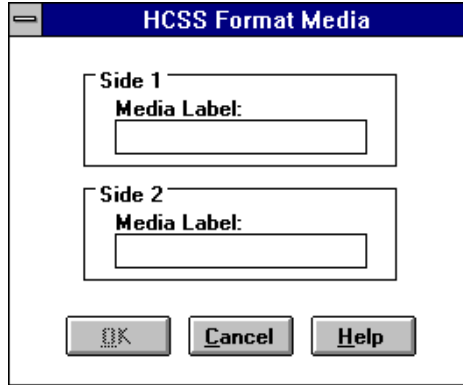
1. **Ensure that you meet the prerequisites.**
2. **From the “HCSS Media Management” dialog box, choose “Format.”**

A message appears, warning you about erasing data and asking if you are sure you want to format the media. When you select “Yes,” the dialog box in Figure 6-9 appears.



If you are reformatting media, the previous media labels appear as defaults in the “Media Label” boxes.

**Figure 6-9**  
**“HCSS Format**  
**Media” Dialog Box**

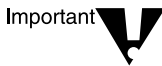


**3. Enter the media label names.**



Since labels should not be changed except by reformatting the media, you should plan your labels carefully.

Type a unique label for each side of media in the “Media Label” boxes for side 1 and side 2.



Each media label is used to create a media-label directory; therefore, each media label must be unique.

Labels can be no longer than eight characters and must not have extensions. The following character sets are allowed: uppercase A–Z and 0–9.

The media labels you enter here become the HCSS media-label directory names.

**4. Select one of the options from the following table:**

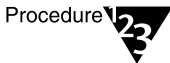
If you	Choose	Then go to
Want to accept the format, label the media, and assign the media-label directories	OK	“Assigning HCSS Media to Domain Directories” on page 377
Do not want to format or label the media	Cancel	Step 7 in “Importing Media” on page 372 (where you can exit through the “HCSS Media Management” dialog box)

## Assigning HCSS Media to Domain Directories

The existence of HCSS media-label directories implies the existence of media labeled with the same name.

You can assign one or more pieces of media (and therefore media-label directories) under an HCSS domain directory. You are limited only to the number of media your jukebox will hold.

### Procedure

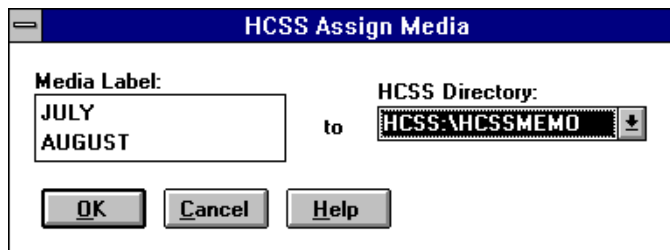


1. Ensure that the “HCSS Assign Media” dialog box is on the screen.

Figure 6-10 shows an example of this dialog box.

If you have just imported or formatted media, the box should already be displayed. (If the box isn’t displayed, refer to the procedures in “Importing Media” on page 372 and make the appropriate selections until the box appears.)

Figure 6-10  
“HCSS Assign  
Media” Dialog Box



The two media labels you entered when you formatted the media appear in the “Media Label” list box.

All domain directories assigned to the HCSS volume are listed in the “HCSS Directory” drop box on the right side of the screen.

2. From the “HCSS Directory” drop box, select an HCSS directory.
3. Choose “OK.”

The HCSS media-label directories are assigned to the HCSS domain directory you selected.

4. **(Optional) To return to the “HCSS Media Management” dialog box, select “Cancel.”**
5. **(Optional) To return to the browser, select “Cancel” one or more times.**

As you return to the browser, the unassigned piece of media is ejected.
6. **(Optional) To label media and assign other media-label directories to a domain directory, return to Step 3 on page 372.**

Your HCSS directories and files should now be ready for migration.

## Managing the HCSS File System

You might need to perform some or all of the following tasks to manage or maintain your HCSS file system:

- ◆ Export media
- ◆ Reload (import) media
- ◆ Delete an existing HCSS directory
- ◆ Reformat media



Always use the HCSS options in the NetWare Administrator utility to change HCSS domain directories and media-label directories.

Always use the “HCSS Import Media” and “HCSS Export Media” options in NetWare Administrator to load and unload media; do not manually load media into the jukebox until prompted by the software.

Never rename subdirectories once they are created under media-label directories.



## Exporting Media

You must use HCSS commands to export (remove) media from the jukebox.

Exporting media removes the two associated HCSS media-label directories and their contents from the NetWare<sup>®</sup> file system. All files that were cached on the volume are first migrated to media, and then the media is ejected.

You might want to export media to

- ◆ Store media with its directories and files intact
- ◆ Assign specific media-label directories and data to a different HCSS domain directory
- ◆ Reformat media or move it to a jukebox on a different server

If the export operation fails, you get a message that HCSS cannot export the media.

The export operation will fail if:

- ◆ Files are open
- ◆ Files are not archived and the Migrate Unarchived Files parameter is turned off
- ◆ The Migrate Compressed Files Only parameter is turned on
- ◆ Files are flagged with the Execute Only file attribute
- ◆ Subdirectories under the media-label directory have the Don't Migrate attribute set
- ◆ There is not enough room on the media to hold all of the unmigrated files that are assigned to it

To make sure files are not in use before exporting media, use the SEND utility at the server console (or at the MSEngine prompt if you are running SFT III) to notify users that you are exporting media.



During the export process, access to migrated data on other media is denied.

**Procedure**

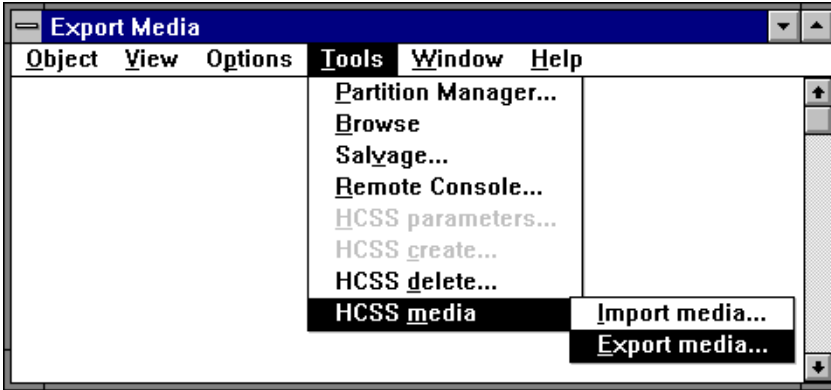
1. **Start NetWare Administrator.**
2. **From the browser, select the HCSS volume; then select the HCSS domain directory to which the media is assigned.**

For information about moving around in the browser and selecting objects, choose “Help” from the menu bar.

3. **From the “Tools” menu, select “HCSS Media.”**
4. **From the “HCSS Media” menu, select “Export Media.”**

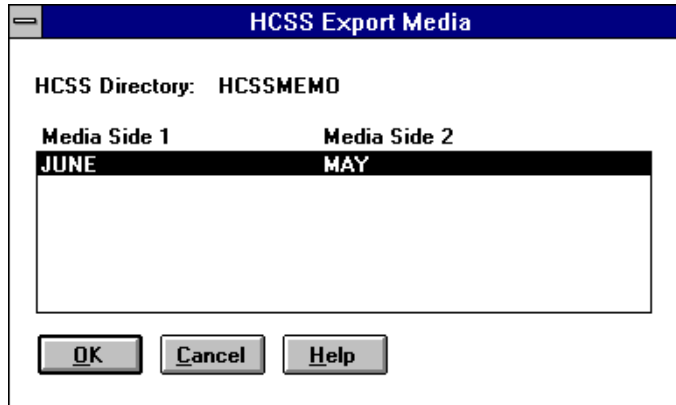
(See Figure 6-11.)

**Figure 6-11**  
**Selecting the “Export Media” Option**



A dialog box similar to Figure 6-12 appears.

Figure 6-12  
“HCSS Export  
Media” Dialog Box



5. **Select the pair of HCSS media-label directories for the media you want to export.**

6. **Choose “OK.”**

The names of the HCSS directories are removed from the browser. If the HCSS files are currently located on the server’s hard disk, you must wait while they are migrated back to the media in the jukebox.

7. **When the “Remove Media” prompt is displayed, remove the media from the jukebox.**

Both the directory structure and the file data are removed from the file system.

8. **Choose “OK.”**

The dialog box disappears and you are returned to the browser.

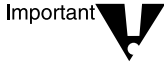
## Reloading Media

You can reload the files on exported media, and add the corresponding HCSS media-label directories and contents to your file system, by importing the media with the NetWare Administrator utility.

To import previously formatted media into the jukebox with files and directories intact, follow the procedures in “Creating HCSS Media-Label Directories” on page 371.

## Deleting an HCSS Domain Directory

Deleting an HCSS domain directory removes it from the NetWare file system.



You must use NetWare Administrator to delete an HCSS domain directory. Using a command line delete or some other delete utility will confuse the jukebox inventory and might cause media to begin ejecting from the jukebox.

### Procedure



1. **Export all media whose labels appear as HCSS media-label directories under the HCSS domain directory you are deleting.**

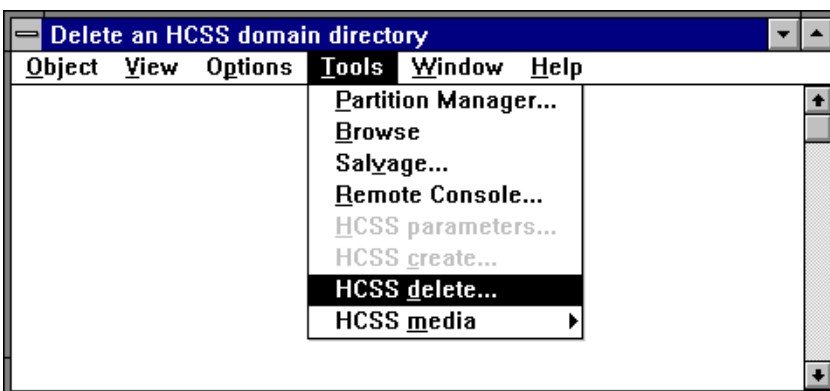
For instructions, see “Exporting Media” on page 379.

2. **Delete or move any non-HCSS files and directories from the HCSS domain directory, using standard NetWare commands.**

If you had both HCSS and non-HCSS files in the same domain directory, the non-HCSS files are probably those remaining after you have exported all media in the domain directory.

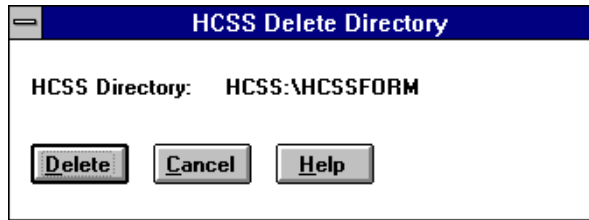
3. **From the browser, select the name of the HCSS domain directory you want to delete.**
4. **From the “Tools” menu, select “HCSS Delete” (Figure 6-13).**

Figure 6-13  
Selecting the “HCSS Delete” Option



The “HCSS Delete Directory” dialog box appears. (See the example in Figure 6-14.)

Figure 6-14  
“HCSS Delete  
Directory” Dialog  
Box



5. Choose “Delete.”

The HCSS domain directory name is removed from the browser and the file system.

## Reformatting Media



Warning

Reformatting media erases all files and directories stored on the media.

You might want to reformat media to

- ◆ Erase all files and directories stored on the media
- ◆ Create new media labels (HCSS media-label directory names)
- ◆ Assign media to an HCSS directory

To reformat media:

1. Perform the procedures under “Importing Media” on page 372.
2. Perform the procedures under “Formatting Media” on page 375.
3. (Optional) If you want to assign media to domain directories at this time, perform the procedures under “Assigning HCSS Media to Domain Directories” on page 377.

## Checking Media Status

HCSS provides a command you can use to check media status and verify that migration has occurred.

To check HCSS media status, from the server console prompt (MSEngine prompt if you are running SFT III), type the following:

```
HCSS Media Status = [path]
```

The path should include the volume name.

For example:

```
HCSS Media Status = HCSSVOL:\domain_dir\media-  
label_dir
```

After you enter the command, the following information about the specified media appears:

- ◆ **Total Bytes:** The total capacity of media, in bytes, for a media-label directory
- ◆ **Used Bytes:** How much space is currently being used in bytes
- ◆ **Migrated Files:** The number of files that have been migrated to this side of media

## Managing HCSS Parameters

You can customize your HCSS volume and define how the volume and jukebox interact by setting various HCSS parameters. You can set or change these parameters either through Windows, using NetWare Administrator, or at the server console prompt (MSEngine prompt if you are running a NetWare 4.11 SFT III™ system).



Note

All HCSS parameters have default settings. You don't need to change these settings unless you want to customize HCSS operations.

(For information on the default settings, see "Setting Parameters Using NetWare Administrator" on page 390 or "Setting Parameters at the Server Console" on page 397.)

## What the Parameters Do

Several parameters work together and allow you to specify

- ◆ If and when data migration occurs (see “Migration If/Then Parameters” on page 385)
- ◆ How media requests are handled (see “Media and Media Request Parameters” on page 386)
- ◆ Which decision-making features are used, either by you or by HCSS (see “Decision-Making Parameters” on page 389)

### Migration If/Then Parameters

The following HCSS parameters let you specify if and exactly when data will migrate to the jukebox.

#### Disable Migration

Turn on this parameter when you need to disable migration for any reason—such as reducing demands on the processor or jukebox.

#### Migrate Unarchived Files

Turn on this parameter to allow migration of files that have not been backed up. By default this parameter is turned off, which means that files won’t migrate until the archive bit has been cleared. The bit is cleared when the files have been backed up.



If you attempt to export media with the Migrate Unarchived Files parameter turned off, and the associated files are unarchived, the media will not be exported.

#### Migrate Compressed Files Only

If this parameter is set, HCSS migrates only those files that have been compressed (files flagged with “Co”) or files that can’t be compressed (files flagged with “Cc”). Files that can’t be compressed are those that wouldn’t save any space if they were compressed.

For more information on file flags, see “FLAG” in *Utilities Reference*.

### **Upper Threshold**

This parameter specifies how full the volume can become before file data begins migrating to the jukebox. This value can be set from 1% to 100%, but it must be higher than the lower threshold.

The upper threshold should be set so that the most frequently used files remain cached on the volume.

### **Lower Threshold**

This parameter specifies how full the volume will be after migration ends. The value is a percentage of full, and it must be lower than the upper threshold percentage.

### **Migrate to Lower Threshold Hour/Minute**

This parameter specifies a time when data will migrate, regardless of whether the upper threshold is reached. This parameter can be disabled.

Whether or not the parameter is enabled, migration will still be initiated when the volume capacity reaches the upper threshold.

## **Media and Media Request Parameters**

### **Eject Media Override**

Turn on this parameter at the server console prompt to send a message to HCSS to stop media from ejecting during jukebox inventory.

This parameter can be set only from the server console prompt.

When HCSS is loaded, it performs a jukebox inventory that detects any inconsistencies between the media-label directories and the labeled media in the jukebox. HCSS will attempt to eject any media without corresponding media-label directories.



If the jukebox begins ejecting media when you load HCSS, and you believe the media belongs in the jukebox

1. Turn this parameter on, allow HCSS to finish loading, and then manually place the ejected media back in the jukebox.
2. Unload HCSS and the jukebox driver (HPCHGR) and determine the status of the volume and media-label directories.
3. Correct the problem (for instance, if your volume wasn't mounted, mount it now) and reload the jukebox driver and then HCSS.

### **Delete Through**

Setting this parameter turns off asynchronous delete requests (where response to the request is not synchronized with the actual deletion of files from media), and files are deleted from media before the delete request is completed.

Normally, when you delete a file, the file is placed in a delete queue and the delete request is completed. It is not actually deleted from the media until other, higher priority requests have been completed (such as demigrations).

Use this parameter if, for security purposes, you want to delete all the way through to the media and not be placed in a delete queue, even if the delete request takes longer.

### **Minimum Time In Drive**

This parameter works in conjunction with the Maximum Time in Drive parameter and the Request Idle Time parameter, and it specifies the minimum amount of time that the media remains in the drive for servicing (or waiting to service) requests for the loaded side of media.

If the media is not already in the drive, part of the Minimum Time In Drive time is spent moving it into place.

During the Minimum Time In Drive time, the media remains in the drive even if there are no additional requests for that side of media.

### **Maximum Time In Drive**

This parameter works in conjunction with the Minimum Time in Drive parameter and the Request Idle Time parameter. It specifies the maximum amount of time media remains in the drive servicing requests before being removed to allow a request on another side of media.

The Maximum Time In Drive time must be greater than the Minimum Time In Drive time.

### **Request Idle Time**

This parameter works in conjunction with the Maximum Time in Drive parameter and the Minimum Time In Drive parameter, and it defines a short grace period to wait for additional requests for files on the media loaded in the drive.

This grace period begins after the Minimum Time In Drive time has expired.

If the grace period expires before a request is received, the media may be removed to service a request on another side of media.

If a request is received during this grace period, the grace period begins again. This process continues until the Maximum Time In Drive time is reached.

The Request Idle Time must be less than the difference of the Maximum Time In Drive and Minimum Time In Drive settings.

## Decision-Making Parameters

HCSS periodically scans the HCSS domain directories and their subdirectories for migratable files and builds an LRU list. The first file on the LRU list (the oldest file on the list) is the first file migrated when either the upper threshold or the preset migration time is reached.

If you have a large number of files in the HCSS volume and HCSS is dominating your hard drive for an unacceptable period while building the LRU list, you can reduce the impact by doing one or both of the following.

- ◆ Setting or decreasing the Marked Files Limit parameter (default = 0, no limit)
- ◆ Increasing the Marking Frequency parameter

### Marked Files Limit

This parameter is used to limit the number of files on the LRU list. When the limit is reached, HCSS stops scanning the HCSS volume for migratable files. If there are many files to be migrated, you can reduce the demand on system resources by adjusting this value. Usually this parameter is left at 0, which means no limit.

If, for example, a file system had 10,000 migratable files with no Marked Files Limit (the setting was 0), the LRU list would have 10,000 files as candidates for migration. If the same system had a Marked Files Limit of 5000, then only the first 5000 migratable files found would go on the list. After the first 5000 files had migrated, the next list generated would include the remaining 5000 migratable files.

Placing a limit on the LRU list means that the first file migrated is the least recently used of those on the list and *not* necessarily the least recently used file on the volume.



Note

If a certain number of files cannot be migrated for some reason, and if the Marked Files Limit parameter is set at a value equal to or less than that number, then no files will migrate. Each time the LRU list is built, it will contain the same list of unmigratable files.

### Marking Frequency

Use this to specify how often HCSS builds an LRU file list. The larger this number, the longer HCSS will rest between building LRU lists.

### **Polling Frequency**

This parameter specifies how often you want HCSS to check if the upper threshold has been reached, indicating that it is time to migrate.

### **Remaining Capacity Before Warning**

This parameter specifies at what capacity you want to be notified that a side of media is almost full. For example, if you set the value to 20%, you will be notified when the media is 80% full.

### **Warning Frequency**

This parameter specifies how often you want to be warned that sides of media are almost full. The warning is a broadcast message to user ADMIN or equivalent.

## **Setting Parameters Using NetWare Administrator**

For more information on HCSS parameters, see “What the Parameters Do” on page 385.

### **Prerequisites**



- HCSS hardware and server software installed
- A volume created and set up for the HCSS file system
- You are logged in as ADMIN, or equivalent, to the server on which HCSS is loaded
- A workstation running NetWare Administrator

**Procedure**

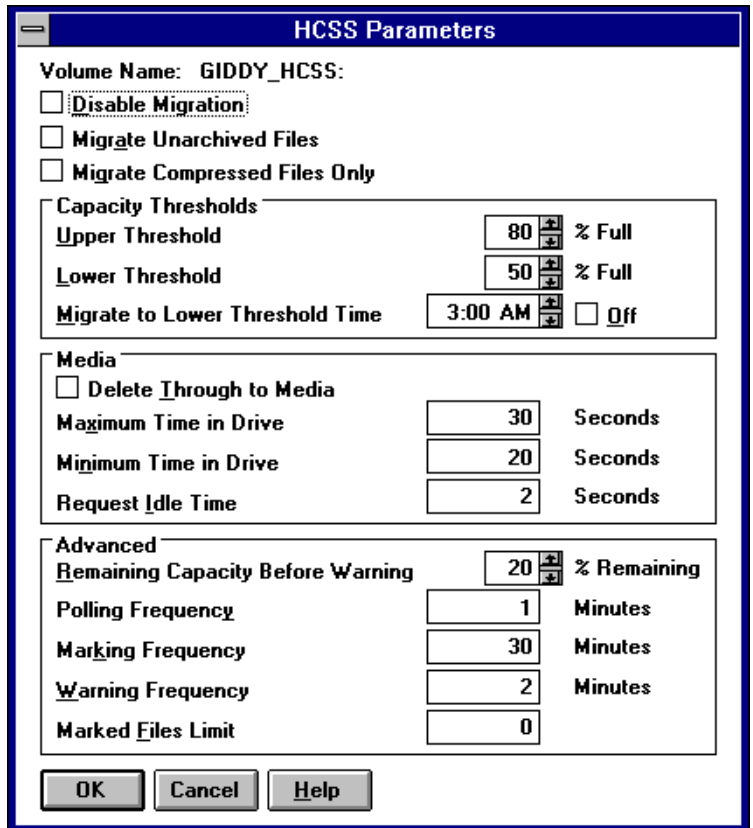
1. **Start NetWare Administrator.**
2. **From the browser, select the HCSS volume.**

For information about moving around in the browser and selecting objects, choose “Help” from the menu bar.

3. **From the “Tools” menu, select “HCSS Parameters.”**

The “HCSS Parameters” dialog box appears. (See Figure 6-15.)

**Figure 6-15**  
**The “HCSS**  
**Parameters” Dialog**  
**Box**



**4. In the “HCSS Parameters” dialog box, make changes to some or all of the parameters, as needed.**

See Table 6-2 for information on how to change individual parameter settings.



Parameter settings marked with an asterisk (\*) in the table are persistent (that is, the setting stays the same unless you change it). The nonpersistent parameter settings reset to the default setting every time HCSS is loaded.

You can create an .NCF file to load and set the nonpersistent parameters to your desired settings. (For more information about creating an .NCF file, see “Creating or Editing a Server Batch (.NCF) File” on page 416.)

**5. When you have finished setting the parameters, choose “OK.”**

The new settings are activated. (Choosing “Cancel” returns you to the browser and does not save the new settings.)

**Table 6-2**  
**How to Set HCSS Parameters Using NetWare Administrator**

Parameter	Purpose	Parameter Setting Information
Disable Migration	Turns migration on or off.  (For more information, see “Disable Migration” on page 385.)	Select (place an X in the box) to turn off migration.  Deselect (remove X from box) to reenale migration.  Default setting: deselected (no X).
Migrate Unarchived Files	Allows migration of files that have not been backed up.  (For more information, see “Migrate Unarchived Files” on page 385.)	Select (place an X in the box) to allow migration of unarchived files.  Deselect (remove X from box) to prevent migration of unarchived files.  Default setting: deselected (no X).

Table 6-2 *continued*

**How to Set HCSS Parameters Using NetWare Administrator**

Parameter	Purpose	Parameter Setting Information
Migrate Compressed Files Only	Allows only compressed files to be migrated.  (For more information, see "Migrate Compressed Files Only" on page 385.)	Select (place an X in the box) to enable the parameter. Only compressed files, or files that can't compress, will be migrated.  Deselect (remove X from box) to disable the parameter.  Default setting: deselected (no X).
Upper Threshold*	Sets the upper threshold of volume space that can be used before files are migrated to media.  (For more information, see "Upper Threshold" on page 386.)	Click on the up or down arrow until you find the setting you want.  Set anywhere from 1 to 100%, but higher than the lower threshold.  Default setting: 80 (migration begins when the volume has 20% free volume space remaining).
Lower Threshold*	Sets the lower threshold of volume space at which files stop migrating to media.  (For more information, see "Lower Threshold" on page 386.)	Click on the up or down arrow until you find the setting you want.  Set anywhere from 0 to 99%, but lower than the upper threshold.  Default setting: 50 (migration stops when the volume has 50% free volume space remaining).

Table 6-2 *continued*

**How to Set HCSS Parameters Using NetWare Administrator**

Parameter	Purpose	Parameter Setting Information
Migrate to Lower Threshold Time*	<p>Sets the time when you want files to begin migrating automatically.</p> <p>(For more information, see “Migrate to Lower Threshold Hour/Minute” on page 386.)</p>	<p>Click on the up or down arrow until you find the setting you want or select the “Off” box to disable this parameter.</p> <p>Select a time when file access is least likely to occur, but not to exactly midnight, unless you want to disable this parameter.</p> <p>Default setting: 3:00 a.m. (migration begins at that time).</p>
Delete Through to Media	<p>Turns off asynchronous deletes, allowing deletion of data from the media to synchronize with the response to a requested delete</p> <p>(For more information, see “Delete Through” on page 387.)</p>	<p>Select (place an X in the box) to enable the parameter, which allows data to be deleted from media before the delete request completes.</p> <p>Deselect (remove X from box) to disable the parameter.</p> <p>Default setting: deselected (no X).</p>
Maximum Time In Drive	<p>Sets the maximum amount of time (in seconds) a side of media will remain active before changing to another side of media</p> <p>(For more information, see “Maximum Time In Drive” on page 388.)</p>	<p>Select this parameter and type in the time (in seconds).</p> <p>Supported settings: 0 to 3600, but must be greater than the Minimum Time In Drive time.</p> <p>Can be set for 1 hour if converted into seconds (for example, 1 hour=3600.)</p> <p>Default setting: 30 seconds.</p>



Table 6-2 *continued*

**How to Set HCSS Parameters Using NetWare Administrator**

Parameter	Purpose	Parameter Setting Information
Minimum Time In Drive	<p>Sets the minimum amount of time (in seconds) a side of media will remain active before changing to another side of media.</p> <p>(For more information, see “Minimum Time In Drive” on page 387.)</p>	<p>Select this parameter and type in the time (in seconds).</p> <p>Supported settings: 0 to 3600, but must be less than Maximum Time In Drive.</p> <p>Default setting: 20 seconds.</p>
Request Idle Time	<p>Sets the grace period during which additional requests for the media loaded in the drive will be accepted.</p> <p>(For more information, see “Request Idle Time” on page 388.)</p>	<p>Select this parameter and type in the time (in seconds).</p> <p>Supported settings: Any fraction of the difference between the Maximum Time In Drive and Minimum Time In Drive times.</p> <p>Default setting: 2 seconds.</p>
Remaining Capacity Before Warning	<p>Specifies at what media capacity you want to be notified that a side of media is filling up.</p> <p>This works in conjunction with the Warning Frequency parameter to determine when you are notified.</p> <p>(For more information, see “Remaining Capacity Before Warning” on page 390.)</p>	<p>Click on the up or down arrow until you find the setting you want.</p> <p>Supported settings: 0 to 100 percent.</p> <p>Default setting: 20.</p>
Polling Frequency*	<p>Specifies how often (in minutes) you want HCSS to check the thresholds you have set.</p> <p>(For more information, see “Polling Frequency” on page 390.)</p>	<p>Set this anywhere from 1 minute to 24 days (days converted into minutes).</p> <p>Supported settings: 1 to 34560.</p> <p>Default setting: 1.</p>

Table 6-2 *continued*

**How to Set HCSS Parameters Using NetWare Administrator**

Parameter	Purpose	Parameter Setting Information
Marking Frequency*	<p>Specifies how often (in minutes) HCSS builds a least-recently used (LRU) file list.</p> <p>(For more information, see “Marking Frequency” on page 389.)</p>	<p>Set this anywhere from 1 minute to 24 days (days converted into minutes).</p> <p>Supported settings: 1 to 34560.</p> <p>Default setting: 30.</p>
Warning Frequency*	<p>Sets how often (in minutes) you want to be warned that the volume has exceeded its upper capacity threshold.</p> <p>(For more information, see “Warning Frequency” on page 390.)</p>	<p>Set this anywhere from 1 minute to 24 days (days converted into minutes).</p> <p>Supported settings: 1 to 34560.</p> <p>Default setting: 2.</p>
Marked Files Limit	<p>Limits the number of migratable files that are placed on the LRU list.</p> <p>(For more information, see “Marked Files Limit” on page 389.)</p>	<p>Supported settings: Any number smaller than your total number of migratable files.</p> <p>Default setting: no limit (0).</p>

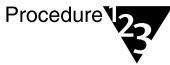
# Setting Parameters at the Server Console

For an overview of all the HCSS parameters, see “What the Parameters Do” on page 385.



### Prerequisites

- HCSS hardware and server software installed
- A volume created and set up for the HCSS file system
- You are logged in as ADMIN, or equivalent, to the server on which HCSS is loaded



### Procedure

1. **(Optional) View the list of HCSS parameters and their current settings.**

At the server console prompt, type

```
HCSS <Enter>
```

2. **(Optional) Change any HCSS parameter, as needed, using the following syntax:**

```
HCSS [parameter = setting]
```

Replace *parameter* and *setting* with a parameter name and the applicable setting found on Table 6-3.



Parameters marked with an asterisk (\*) in the table are persistent (that is, the setting stays the same unless you change it). The nonpersistent parameters reset to the default setting every time HCSS is loaded.

You can create an .NCF file to load and set the nonpersistent parameters to your desired settings. (For more information about creating an .NCF file, see “Creating or Editing a Server Batch (.NCF) File” on page 416.

**Table 6-3**  
**How to Set HCSS Parameters at the Server Console**

Parameter Syntax	Supported Settings	Purpose of Parameter
(no parameter = setting)	(no setting)	Displays a list of HCSS parameters and current settings.
Eject Media Override = <i>setting</i>	ON, OFF. Default: OFF.	Stops media in the jukebox from being ejected during jukebox inventory.  (For more information, see “Eject Media Override” on page 386.)
Delete Through = <i>setting</i>	ON, OFF. Default: OFF.	When turned off, expedites requests for deletes.  (For more information, see “Delete Through” on page 387.)
Migrate Unarchived Files = <i>setting</i>	ON, OFF. Default: OFF.	Allows migration of files that have not been backed up.  (For more information, see “Migrate Unarchived Files” on page 385.)
Migrate Compressed Files Only = <i>setting</i>	ON, OFF. Default: OFF.	Allows only files that are compressed (or that can't compress) to be migrated.  (For more information, see “Migrate Compressed Files Only” on page 385.)
Maximum Time In Drive = <i>setting</i>	0 to 3600, but must be greater than the Minimum Time In Drive setting. Default: 30 (seconds).	Sets the maximum amount of time (in seconds) a side of media will remain active before changing to another side of media.  (For more information, see “Maximum Time In Drive” on page 388.)
Minimum Time In Drive = <i>setting</i>	0 to 3600, but must be less than the Maximum Time In Drive setting. Default: 20 (seconds).	Sets the minimum amount of time (in seconds) a side of media will remain active before changing to another side of media.  (For more information, see “Minimum Time In Drive” on page 387.)

Table 6-3 *continued*

**How to Set HCSS Parameters at the Server Console**

Parameter Syntax	Supported Settings	Purpose of Parameter
Request Idle Time = <i>setting</i>	Set this to a fraction of the difference between the Maximum Time In Drive and Minimum Time In Drive settings.  Default: 2 (seconds).	Sets the grace period during which additional requests for the media loaded in the drive will be accepted.  (For more information, see “Request Idle Time” on page 388.)
Migration = <i>setting</i>	ON, OFF.  Default: ON	Turns migration on or off.  (For more information, see “Disable Migration” on page 385.)
Upper Threshold = <i>setting</i>	1 to 100.*  Default: 80 (percent).	Sets the upper threshold of volume space that can be used before files are migrated to media.  (For more information, see “Upper Threshold” on page 386.)
Lower Threshold = <i>setting</i>	0 to 99.*  Default: 50 (percent).	Sets the lower threshold of volume space at which files stop migrating to media.  (For more information, see “Lower Threshold” on page 386.)
Migrate to Lower Threshold Hour = <i>setting</i>	0 to 23.*  Default: 3 (3:00 a.m.).	Sets the hour when files begin migrating automatically.  When this parameter and the Migrate to Lower Threshold Minute parameter are both set to exactly 0 (the equivalent of 12:00 a.m.), the parameter is disabled.  (For more information, see “Migrate to Lower Threshold Hour/Minute” on page 386.)

Table 6-3 *continued*

### How to Set HCSS Parameters at the Server Console

Parameter Syntax	Supported Settings	Purpose of Parameter
Migrate to Lower Threshold Minute = <i>setting</i>	0 to 59.* Default: 0 (12:00 a.m.).	<p>Sets the minute of the hour when files begin migrating automatically.</p> <p>When this parameter and the Migrate to Lower Threshold Hour parameter are both set to exactly 0 (the equivalent of 12:00 a.m.), the parameter is disabled.</p> <p>(For more information, see “Migrate to Lower Threshold Hour/Minute” on page 386.)</p>
Remaining Capacity Before Warning = <i>setting</i>	10 to 100. Default: 20 (percent).	<p>Specifies when you want to be alerted about the volume’s remaining capacity.</p> <p>(For more information, see “Remaining Capacity Before Warning” on page 390.)</p>
Polling Frequency = <i>setting</i>	1 to 34560.* Default: 1 (minute).	<p>Specifies how often (in minutes) you want HCSS to check the upper and lower thresholds.</p> <p>(For more information, see “Polling Frequency” on page 390.)</p>
Marking Frequency = <i>setting</i>	1 to 34560.* Default: 30 (minutes).	<p>Specifies how often (in minutes) a list of the least recently used directories that are managed by HCSS will be built.</p> <p>(For more information, see “Marking Frequency” on page 389.)</p>
Warning Frequency = <i>setting</i>	1 to 34560.* Default: 2 (minutes).	<p>Specifies how often (in minutes) you will be warned that the volume has exceeded its upper capacity threshold.</p> <p>(For more information, see “Warning Frequency” on page 390.)</p>
Marked Files Limit = <i>setting</i>	The total number of files flagged for migration, or any number smaller than the total. Default: 0 (no limit).	<p>Limits the number of migratable files that are scanned for the LRU list with any setting other than zero (0).</p> <p>(For more information, see “Marked Files Limit” on page 389.)</p>

## ***Maintaining the NetWare Server***

This chapter contains procedures designed to help you manage, optimize, and protect NetWare® servers. Procedures are grouped into the following sections:

- ◆ Common Management Tasks—including basic procedures such as downing a server and creating server batch files
- ◆ Managing Server Connections—including procedures to monitor connection problems and manage communications buffers
- ◆ Monitoring and Optimizing the Server—including ways to manage memory, improve performance, and monitor errors
- ◆ Maintaining Volumes—including mounting and dismounting, creating, deleting, and renaming volumes
- ◆ Managing Server Hard Disks—including instructions for file compression, adding new disks, and mirroring or duplexing hard disks
- ◆ Disaster Prevention and Recovery—including procedures to prevent packet forgery and establish UPS monitoring
- ◆ Using Remote Console to Manage a Server—including procedures for executing remote console sessions over both a direct connection and a modem
- ◆ Administering Accounting—including instructions for setting up accounting, calculating charge rates, and viewing accounting totals

# Common Management Tasks

This section describes typical network supervisor tasks and explains ways you can change the server environment you created during installation of the NetWare 4™ operating system.

## Sending Console Messages to Workstations

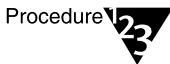
To send a message from the server console to all workstations or to a single user, use the SEND command or the MONITOR NLM program.



Unlike the client SEND command, *groupname* is not a valid parameter at the server.

## Sending a Message to a Specific User Using SEND

### Procedure



- 1. Make sure you are at the server console prompt (:).**

If another screen is displayed (such as MONITOR), press <Alt>+<Esc> to return to the console prompt.

- 2. Type a message, or a series of messages, using the SEND command with the “TO” option.**

Messages can be up to 55 characters.

For information on SEND command syntax, see “SEND” in *Utilities Reference*.

- 3. Enter the username or connection number in the SEND command.**

To determine the username or connection number of a user you want to send a message to, use the “Connection Information” screen in MONITOR.

The form of the user’s name depends on whether the user is logged in as a Novell® Directory Services™ object or as a bindery object, and on where the master replica database is stored.



For example, there are three ways you could send a message to JSMITH, depending on the way the name appears in "Connection Information" in MONITOR.

- ◆ If the name appears as "JSMITH," type the following:

```
SEND "REMEMBER THE MEETING." TO JSMITH <Enter>
```

- ◆ If the name appears as "CN=JSMITH.OU=SALES.O=ABC\_INC," type the following:

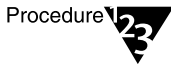
```
SEND "REMEMBER THE MEETING." TO  
CN=JSMITH.OU=SALES.O=ABC_INC <Enter>
```

- ◆ If JSMITH's connection number in the "Connection Information" display is "2," type the following:

```
SEND "REMEMBER THE MEETING." TO 2 <Enter>
```

## Sending a Message to All Workstations Using SEND

### Procedure



1. **Make sure you are at the server console prompt (:).**
2. **Type a message, or a series of messages, using the SEND command.**

Messages can be up to 55 characters.

For example, to send a message to all workstations, type:

```
SEND "SERVER GOING DOWN" <Enter>
```

The message is sent to all workstations.

## Sending a Message Using MONITOR

You can use the MONITOR NLM to send a message to workstations connected to the server.

### Procedure



1. **From the server console prompt, type**  
  
`LOAD MONITOR <Enter>`
2. **From the MONITOR “Available Options” menu, select “Connection Information.”**
3. **Use the arrow keys to highlight a connection. To select multiple connections, highlight each connection and press <F5> to mark it. When the desired connections have been selected, press <F4>.**

The screen displays a text-entry window where you can type the message.

4. **Type the message and press <Enter>.**  
  
The screen displays a confirmation box.
5. **Choose “Yes” to send the message or “No” to redisplay the text-entry window.**

### Additional Information

For more information about	See
Using the SEND utility	“SEND” in <i>Utilities Reference</i>
Using MONITOR	“MONITOR” in <i>Utilities Reference</i>
Receiving and clearing messages at the workstation	<i>NetWare Client for DOS and Windows User Guide</i>  <i>NetWare Client for OS/2 User Guide</i>

## Bringing Down a Server

Use the DOWN utility at the server console to ensure data integrity before turning off power to the server.

DOWN ensures data integrity by writing all cache buffers to disk, closing all files, and updating the appropriate Directory Entry Tables and File Allocation Tables.

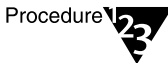


Note

Bringing down a server during a remote console session terminates the session.

If you bring down the server but do not exit, the server is still connected to the network, and it still receives packets. You can continue to execute console commands, such as TRACK ON and TRACK OFF, that deal with packets.

### Procedure



Procedure

1. **At the server console prompt, use SEND to inform all users that they should close all files and log out.**

For example, type

```
SEND "Please close files and log out from server  
  servername." <Enter>  
SEND "Going down in 5 minutes." <Enter>
```

2. **Bring down the server by typing**

```
DOWN <Enter>
```

If files are still open, the console displays the files that are open, the user who opened them, and the workstation connection number.

After executing the DOWN command, you may need to go to the workstation with open files and close them for the user if the workstation is not attended.

You may now exit or restart the server.

## Loading a NetWare Loadable Module

This procedure explains how to load a NetWare Loadable Module™ program (NLM) from the server console.

Checklist



### Prerequisites

- If you are running a message file for the NLM in a language other than English, make sure the language is specified properly. See “Viewing and Setting Server Time and Time Zone” on page 427.
- If the NLM is not in the SYS:SYSTEM directory, either move the NLM to the SYS:SYSTEM directory or add a server search path to the NLM. Otherwise, you must enter the path for the NLM when you execute the LOAD command. See “Viewing and Adding Server Search Paths” on page 410.

### Procedure

Procedure



1. **At the server console prompt, enter the LOAD command.**
  - ◆ Use this format to load an NLM residing in SYS:SYSTEM:  
`LOAD NLM <Enter>`
  - ◆ Use this format to load an NLM located on drive A:  
`LOAD A:NLM <Enter>`
2. **If you want the NLM to be loaded whenever the server boots, add the LOAD command to the AUTOEXEC.NCF file.**

### Additional Information

For more information about	See
Using the LOAD utility	“LOAD” in <i>Utilities Reference</i>

## Loading and Binding LAN Drivers

After you add a network board to your NetWare server, you must load and bind the corresponding LAN driver. Loading a LAN driver establishes a network connection (if the server is physically connected to the network cabling). Binding a LAN driver links a network protocol to the driver and the network board.

The LAN driver you choose depends on the cabling system and the network board you are using.

To load and bind LAN drivers, you can use

- ◆ The INETCFG NLM

Use INETCFG to load LAN drivers and bind them to any supported protocol. For more information, see “INETCFG” in *Utilities Reference*.

- ◆ The LOAD and BIND commands

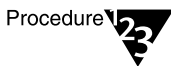
If you know the parameters required by the communication protocol, you can use the LOAD and BIND commands to load and bind LAN drivers at the command line. For more information, see “LOAD” and “BIND” in *Utilities Reference*.

- ◆ The INSTALL NLM

You can use INSTALL to load LAN drivers and bind them to the default protocol IPX™.

The following procedure explains how to use INSTALL to load a LAN driver and bind it to IPX. You can also use this procedure to bind a LAN driver to nonrouting AppleTalk or TCP/IP. To bind a LAN driver to another protocol, use INETCFG or the BIND command.

### Procedure



1. **At the server console prompt, type**

```
LOAD INSTALL <Enter>
```

2. **Choose “Driver Options” from the “Installation Options” menu.**

3. **Select “Configure Network Drivers” from the “Driver Options” menu.**
4. **If you want NetWare to automatically detect all the drivers that are compatible with your network boards, select “Discover and Load Additional Drivers”; otherwise, skip to Step 5.**

Autodetection works only for drivers of boards in advanced buses and for legacy IDE drivers.

If NetWare finds more than one compatible driver for a board, it displays a message listing the hardware it detected.

- 4a. **Press <F3> to see a list of drivers compatible with the detected hardware. Select a driver from the list.**

NetWare automatically finds the parameter values for the driver, loads the driver with the parameters, and then discovers the IPX protocol for the frame type supported for the driver.

NetWare then displays the IPX internal and external network addresses in a confirmation box.

- 4b. **Confirm the addresses.**

After you confirm the addresses, NetWare binds the protocol to the driver.

If you want to load additional drivers that are not autodetected, continue with Step 5.



In machines with PCI buses and sometimes in machines with EISA hardware, INSTALL may not detect all the drivers associated with the LAN adapters. When this happens, INSTALL displays a message listing the hardware for which LAN drivers were not detected. The message prompts you to press <F3> to see a list of all available drivers.

Select the appropriate driver from the list, and skip to Step 7 to modify driver parameters.

5. **To select a driver from all the available drivers, choose “Select an Additional Driver.”**

The screen displays a list of all available drivers.

6. **Choose the driver you want to load, or, if the driver is not on the list, press <Insert>.**

If you press <Insert> to load an unlisted driver, follow the screen prompts. If you select a listed driver, continue with Step 7.



For some drivers, a message may appear indicating that the driver must be loaded manually (at the console prompt). To load a driver manually, follow the screen prompts or press <F1> for more information.

7. **Choose “Select/Modify Driver Parameters.”**

The screen displays a window where you can set values for driver parameters. If you selected an NE2000 driver, the screen also displays a window containing protocol options. The cursor is active in the protocol options window, if it is displayed.



The protocol choices window also lists TCP/IP and AppleTalk. These are nonrouting protocols which you may select instead of IPX. To configure standard TCP/IP, AppleTalk, or other non-IPX protocols, use INETCFG. See “INETCFG” in *Utilities Reference*.

8. **If the window containing protocol choices is displayed, accept the default IPX protocol by pressing the Down-arrow key until the cursor moves to the parameter window.**

9. **Enter parameter values in the fields on the parameter window.**

Press <F1> for help if necessary.

In some cases, the system displays a pop-up list of values for the field from which you select the desired value. In other cases, you must type in a value and press <Enter> to move to the next field.

All frame types are loaded automatically, however, you may specify a specific frame type if desired.

10. **(Optional) To specify a specific frame type for an Ethernet driver, press <F3> to display a selection list of frame types. Select the frame type from the list and press <Enter>.**

**11. When finished, press <F10> to save the values and exit the window**

The system loads the LAN driver and then displays a confirmation window containing the command line to bind IPX to the LAN driver with the specified frame type

At this point, you can either confirm binding of the protocol with the specified frame type or change the frame type

**12. To bind the protocol, press <Enter>. To display the command line with a different frame type, press <F3>.**

Each time you press <F3>, the system displays the command line with another of the available frame types. Press <F3> until the desired frame type is displayed.

**12a. When the frame type you want is displayed, press <Enter> to bind the LAN driver.**

INSTALL automatically places the LOAD and BIND commands in the AUTOEXEC.NCF file.

**Additional Information**

For more information about	See
AppleTalk protocol	"AppleTalk protocols" in <i>Concepts</i>
Frame types	"Ethernet configuration" in <i>Concepts</i>
IPX protocol	"IPX" in <i>Concepts</i>
TCP/IP protocol	"TCP/IP" in <i>Concepts</i>

**Viewing and Adding Server Search Paths**

Adding a server search path allows you to run server utilities and NetWare Loadable Module (NLM) programs and to access server batch files (.NCF files) without specifying the full path to them. Whenever you run a utility or NLM from the server, the server searches for the utility in the current directory and also in the path you specified as a server search path.



## Procedure

**To view current search paths, type the following at the server console prompt:**

```
SEARCH <Enter>
```

The system displays the current search paths in a numbered list. For example,

```
Search 1: [Server path] SYS:SYSTEM
```

```
Search 2: [Server path] A:
```

```
Search 3: [Server path] VOL1:NCF
```

### 13. To add a search path, use one of the following formats:

- ◆ Add a directory or drive as a search path by typing

```
SEARCH ADD path <Enter>
```

For example, this command specifies a search path to VOL1:NCF

```
SEARCH ADD VOL1:NCF <Enter>
```

This command specifies a search path to drive A:

```
SEARCH ADD A: <Enter>
```

- ◆ Add a search path in a particular place in the numbered list of search paths by typing

```
SEARCH ADD number path <Enter>
```

For example, the following command both creates the search path to drive A: and places the path in the second position in the numbered list of search paths.

```
SEARCH ADD 2 A: <Enter>
```

The search path that was previously number 2 becomes number 3, and so on.

**14. To delete a search path, use the following format:**

```
SEARCH DEL number <Enter>
```

Replace *number* with the number of the search path you want to delete.

For more information, see “SEARCH” in *Utilities Reference*.

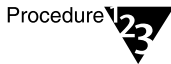
## Installing, Uninstalling, and Configuring a Server Product

The INSTALL NLM allows you to install, uninstall, and configure other NetWare products such as name space modules and NLMs.

If you have questions during the installation or configuration of a product, refer to the documentation that came with the product.

Some products may not have configuration or uninstall options. A message explaining this is displayed if you try to perform unsupported operations.

### Procedure



**1. At the server console prompt, type**

```
LOAD INSTALL <Enter>
```

**2. Choose “Product Options” from the “Installation Options” menu.**

**3. Choose “View/Configure/Remove an Installed Product” from the “Other Installation Actions” menu.**

The “Currently Installed Products” list appears. If no products are currently installed, the list is empty.

**4. Do one of the following:**

- ◆ To install a product, press <Insert> and follow the prompts.
- ◆ To uninstall a product, select the product from the list and press <Delete>.
- ◆ To set configuration options for a product, select the product from the list and follow the prompts.

# Copying NetWare Files

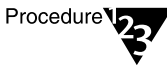
When you do a custom NetWare install, the system installs some, but not all, of the NetWare files. If desired, you can copy the rest of the installation files later by using the “Copy Files” option of the INSTALL NLM. Follow this procedure.

## Prerequisites



- NetWare 4 installation CD-ROM

## Procedure



- 1. At the server console prompt, type**

`LOAD INSTALL <Enter>`

- 2. Select “Copy Files Option” from the “Installation Options” menu.**

The system displays a box containing the default source path from which the files will be copied.

- 3. Press <Enter> to accept the default path, or press <F3> to specify a different path.**

If you press <F3>, the system displays a prompt with the current source path. Backspace to delete the path and type in the new path. Press <Enter>.

The system displays the prompt “Specify a server boot path:”. This is the destination directory—the location to which the files will be copied. This directory must be the boot directory. The default path is C:\.

- 4. Accept the default or type in a new path if your boot directory is not C:\.**

The system displays a list of file groups. An X next to each group means the group is preselected.

**5. Delete the X next to any group(s) you do not want to copy.**

To delete the X, use the arrow keys to move the cursor to the desired group and press <Enter>. The X next to the box disappears.

To reselect a group, move the cursor to the group and press <Enter> again.

**6. When finished selecting groups, press <F10>.**

The system copies the files.

## Extracting NetWare Files from the Installation CD-ROM

If a NetWare system file is accidentally deleted and purged from the network, you can use the NWXTRACT utility to extract the file from the NetWare 4.11 installation CD-ROM or diskettes.

NWXTRACT copies selected files from the installation CD-ROM or diskettes to their default locations on the network or to a user-specified destination.

### Prerequisites



- A workstation running DOS 3.30 or later
- Rights to copy files to the destination directory
- The NetWare 4.11 installation CD-ROM or diskettes
- Name space support, if extracting Macintosh\*, UNIX\*, or OS/2\* files

**Procedure**

1. **If using diskettes, load the diskette containing the file or files you want to extract.**
2. **To extract a file or group of files, type**

```
NWXTRACT path filename | groupname [destination]  
[/option] <Enter>
```

Replace *drive* with the drive letter for the installation CD-ROM or the diskette.

Replace *filename* with the name of the file you want to extract from the CD-ROM or diskette. Or, replace *groupname* with the name of the group of files you want to extract.

Replace *destination* with the destination path for the extracted files, if different from the default destination.

Replace *option* with any of the following:

Option	Description
<i>/S=server</i>   <i>server object</i>	Copies extracted files to their default location on the specified server.
<i>/T=type</i>	Specifies the type of file to be extracted. Valid types are DOS, MAC, OS2, SER (server), UNIX, and WIN.
<i>/?</i>	Displays online help.

3. **To make sure the extracted system files are flagged Read Only, change to the destination directory and type**

```
FLAG filename RO <Enter>
```

See “FLAG” in *Utilities Reference* for information on flagging files.

## Creating or Editing a Server Batch (.NCF) File

When a server is booted, two files are executed:

- ◆ **STARTUP.NCF**—This file loads the server's disk drivers and some SET parameters.
- ◆ **AUTOEXEC.NCF**—This file stores the server name and IPX internal network number, loads the LAN drivers and settings for the network boards, binds the protocol to the installed drivers, and loads other NLM programs.

The following procedure explains how to edit either of these files.

### Procedure



1. **At the server console prompt, type**

```
LOAD INSTALL <Enter>
```

2. **Choose “NCF Files Options” from the “Installation Options” menu.**

The system displays a menu containing options to create or edit both the STARTUP.NCF and AUTOEXEC.NCF files.

3. **Select the desired option and press <Enter>.**

If you select an option to edit one of the files, the selected file appears in a window.

If you select an option to create one of the files, the system displays the existing file in one window and a new file with default entries in another window, so you can compare the two.

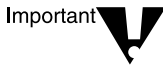
The default entries include only essential contents of the file and reflect the current system setup. For example, the default entries include time zone information and load and bind commands for currently installed LAN drivers. The new file does not include custom configuration settings you may have in the original file.

The cursor is active in the new file. Press <Tab> to toggle between the two files.

**4. Edit the new or existing file as necessary.**

Editing and navigation keystrokes are listed at the bottom of the screen. For additional help, press <F1>.

**5. When finished, save the file by pressing <F10> and selecting “Yes” when prompted. To exit without saving, press <Alt>+<F10>.**



Each time you edit the AUTOEXEC.NCF file or the STARTUP.NCF file, NetWare saves the previous version as AUTONCF.OLD or STARTNCF.OLD.



Changes to the file take effect once you reboot the server.

## Placing Optional Commands in a Server Batch (.NCF) File

By default, a .NCF file executes all the commands within it; the commands are not optional. However, you can make a command optional by placing a question mark (?) in front of it.

The question mark causes the .NCF file to pause at the command and ask you whether to execute it. You can respond either “Yes” or “No.”

For example, the following line in the AUTOEXEC.NCF file causes the file to pause and ask whether to execute the LOAD MONITOR command:

```
? LOAD MONITOR
```

When the AUTOEXEC.NCF file is executed, it displays the following prompt:

```
LOAD MONITOR? y
```

The default response is “Yes.” If you do not respond to the prompt, the default response is executed after 10 seconds.

Both the default response and the time period are configurable.

### Setting the Default Response

There are two ways to configure the default response to the command prompt:

- ◆ Specify the default on the command line. Place the default response (a Y or N) immediately following the question mark. For example,

```
?N LOAD MONITOR
```

In this example, the default response is N. If the user does not respond to the prompt, MONITOR is not loaded.

- ◆ Set the Command Line Prompt Default Choice parameter to either ON or OFF. ON means the default response is Y; OFF means the default response is N. The parameter is in the Miscellaneous category of SET parameters.

The parameter setting is overridden by a default specified on the command line.

## Setting the Time Period

To configure the time period before the default response is executed, set the Command Line Prompt Time Out parameter to a time in seconds. The parameter is in the Miscellaneous category of SET parameters. The default value is 10 seconds.

For information about SET parameters and the SET command, see “SET” in *Utilities Reference*. You can also change SET parameters with the MONITOR or SERVMAN utility. See “MONITOR” or “SERVMAN” in *Utilities Reference*.

## Editing Text Files from the Server Console

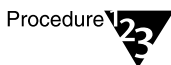
Although you usually edit server files from a workstation, sometimes it is more convenient to edit text files from the server console.

The following procedure explains how to use the EDIT NLM to edit files. You can use EDIT to edit text files on NetWare partitions.



EDIT allows you to edit only text files. Each time you save the file, you can increase the file size by up to 4 KB.

### Procedure



1. At the server console prompt, type



**LOAD EDIT** [*path*] <Enter>

If you specify a path, include both the directory and filename. The file must be located on a mounted volume or on a local drive of the server.

If you do not specify a path, the system displays a prompt at which you can either enter the filename or display a browse window.

- ◆ To enter the filename, type either the complete file path (directory and filename) or just the filename, and press <Enter>.

If you enter only the filename, the system assumes a default directory location of SYS:SYSTEM.

If the file does not exist, EDIT displays a prompt that asks whether the file should be created. Choose “Yes” to create the new file or “No” to redisplay the filename prompt. If you choose “Yes,” EDIT displays a blank screen so you can enter text into the file.

- ◆ To display the browse window, press <Insert>.

To see the contents of a volume or directory, highlight the volume or directory name and press <Enter>. Use the arrow keys to scroll up and down the list of files and directories. To display a file, highlight the filename and press <Enter>.

The file is displayed on the screen, ready for editing.

## **2. Edit the file as needed.**

The keys used to edit text are described in Table 7-1.

**Table 7-1**  
**Editing Keys Available in the EDIT NLM**

Key	Function
Arrow keys	Move up/down one line or left/right one character.
Backspace	Delete character to left of cursor.
<Ctrl>+<PageUp>	Move to beginning of document.
<Ctrl>+<PageDown>	Move to end of document.
<Delete>	Delete the character at the cursor location or delete blocked text.
<End>	Move to end of line.
<Esc>	Exit the file. You are prompted to save any changes.
<F5>	Highlight (block) text for copying or deleting. Toggles highlighting on and off.
<F6>	Copy highlighted (blocked) text to a buffer.
<Home>	Move cursor to beginning of line.
<Insert>	Insert text from buffer.
<PageUp>	Move up one page
<PageDown>	Move down one page.
<Tab>	Move cursor four spaces to the right.

- 3. When finished editing, press <Esc>. Select “Yes” to save the file or “No” to exit the file without saving changes.**

The system redisplay the pathname prompt.

- 4. To edit another file, enter the file pathname. To redisplay the console prompt, press <Esc>.**

## Setting a Server's Language

The NetWare 4.11 operating system and its NLM programs and utilities use the language the server was installed in, unless you specify otherwise.

This section explains how to specify a new server language. The first step is to copy the new language files to the server. The second step is to set the server to the new language.

Subsequent sections explain how to change the language for the NLM programs you load on the server and how to change the keyboard type.

### Copying the Language Files to the Server

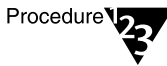
Before you can change the server language, you must copy the language files to the server from the installation CD-ROM or another server. Follow this procedure to copy the files.

#### Prerequisites



- Installation CD-ROM or access to another NetWare server containing the language files

#### Procedure



- 1. At the server console prompt, type**  
  
`LOAD INSTALL <Enter>`
- 2. From the “Installation Options” menu, select “Product Options.”**
- 3. From the “Other Installation Actions” menu, select “Choose an Item or Product Listed Above.”**

- 4. From the “Other Installation Items/Products” menu, select “Install an Additional Server Language.”**

The system displays a box containing the path from which you last installed files. In most cases, this is the path to the language files for the *current* language. For example, if you last installed NetWare files in English, this is the path to the English files.

You should accept the path to the current language files so that help and system messages are displayed in the current language during the install procedure.

If, for some reason, the path is not to the current language files, then you should enter the path to the current language files. See the next step.

- 5. Press <Enter> to accept the displayed path, or press <F3> and type in the correct path to the current language files.**

The path to the current language files has this syntax:

```
SERVER | CD:\NW410\INSTALL\current_language
```

If you are installing the files from another server, the system may prompt you for a username and password for that server. Follow the prompts.

The system displays a window listing groups of language files.

- 6. Use the arrow keys to move the cursor to the language you want to install and press <Enter>.**

The system marks the selected language with an “X.” You can specify several languages, if desired.

To deselect a language, move the cursor to the language and press <Enter> again.

- 7. When you have finished selecting languages, press <F10>.**

The system copies the selected language files.

After the files are copied, you can change the server language at any time. See the next section, “Changing the Server’s Language” on page 423.

## Changing the Server's Language

Follow this procedure to change the server language.

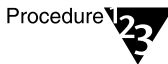


This procedure requires you to reboot the NetWare server because you set the server language when executing SERVER.EXE. You may want to perform this procedure after business hours.



### Prerequisites

- Language files copied to the server. (See “Copying the Language Files to the Server” on page 421.)



### Procedure

1. **At the server console prompt, type**  
  
`LOAD INSTALL <Enter>`
2. **From the “Installation Options” menu, select “Product Options.”**
3. **From the “Other Installation Actions” menu, select “Choose an Item or Product Listed Above.”**
4. **From the “Other Installation Items/Products” menu, select “Change Server Language.”**

The system displays a box containing the path from which you last installed files. In most cases, this is the path to the language files for the *current* language. For example, if you last installed NetWare files in English, this is the path to the English files.

You should accept the path to the current language files, so that help and system messages are displayed in the current language until you have completed the change to the new language.

If, for some reason, the path is not to the current language files, then you should enter the path to the current files. See the next step.

- 5. Press <Enter> to accept the displayed path, or press <F3> and type in the correct path to the current language files.**

The path to the current language files has this syntax:

```
SERVER | CD:\NW410\INSTALL\current_language
```

If the current language files are on another server, the system may prompt you for a username and password for that server. Follow the prompts.

The system displays a menu listing the available languages.

- 6. Choose the desired language from the menu.**

You must choose a language that you installed earlier with the “Install an Additional Server Language” option of INSTALL. (See “Copying the Language Files to the Server” on page 421.)

If this is the first time you have changed the language, the system displays a prompt specifying the default destination where the language files are to be placed. The default location is the bootup directory, C:\NWSERVER.

The language files must be placed in your bootup directory.

- 7. Accept the default or type a new path.**

Once you specify the bootup directory, the system loads the language files.

- 8. Reboot the server to change the server language.**

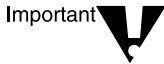
### Additional Information

For more information about	See
Setting language for a workstation	<i>NetWare Client for DOS and Windows User Guide</i> <i>NetWare Client for OS/2 User Guide</i>
Languages for NetWare	“International use of NetWare 4” in <i>Concepts</i>

## Specifying a Language for an NLM

Use the LANGUAGE command to change the language for subsequently loaded NLM programs. The LANGUAGE command does not change the language for currently loaded modules.

For consistent language display, you should also change the server language as explained in the previous section, “Changing the Server’s Language” on page 423.



If you change the NLM language without changing the server language, the NLM still displays some character strings and screen titles in the server language.

To see a list of languages, type

```
LANGUAGE LIST <Enter>
```

The system displays a list of languages and their ID numbers. (Not all languages in the list are supported. Additional languages may be available in the future.)

To determine the currently specified NLM language, type

```
LANGUAGE <Enter>
```

### Prerequisites



- The name or number of the language you want to use. Use the LANGUAGE LIST command to determine the correct name and number.

## Procedure



### To change the language for subsequently loaded NLM programs, type

```
LANGUAGE language_number | language_name <Enter>
```

For example, to change the language to German, type

```
LANGUAGE 7 <Enter>
```

or

```
LANGUAGE GERMAN <Enter>
```

## Additional Information

For more information about	See
Languages for NetWare	"LANGUAGE" in <i>Utilities Reference</i> "International use of NetWare 4" in <i>Concepts</i>

## Changing the Server Keyboard Type

NetWare 4 allows you to use keyboard types other than U.S. English by loading the KEYB.NLM program. The language you specify with KEYB.NLM must match the language of your keyboard, not the server language.

The keyboard type can be changed without rebooting the server.



Changing the keyboard type causes some of the keys on your keyboard to represent different characters. Do not use this command unless you have the appropriate keyboard for the language you are specifying and you are familiar with the keyboard's use. Otherwise, you may not know which keys to use to change the keyboard back to its original language.





## Procedure

1. To view a list of valid keyboard types, type
2. From the list of keyboard types, find the keyboard type that matches the one you are using.
3. To change the keyboard type to match your keyboard, type

```
LOAD KEYB <Enter>
```

```
LOAD KEYB <keyboard_type> <Enter>
```

For example,

```
LOAD KEYB GERMANY <Enter>
```

## Additional Information

For more information about	See
Languages for NetWare	"International use of NetWare 4" in <i>Concepts</i>
Languages supported by KEYB	"KEYB" in <i>Utilities Reference</i>

## Viewing and Setting Server Time and Time Zone

Three server commands allow you to view and set server time and time zone: TIME, SET TIME, and SET TIME ZONE.

### Viewing Server Time

To display the date and time kept by the NetWare server's clock, type the following at the server console:

```
TIME <Enter>
```

In addition to the date and time, the TIME command displays the server's daylight-saving-time status and time synchronization status. For more information, see "TIME" in *Utilities Reference* and "Time synchronization" in *Concepts*.

## Setting Server Time



Because time synchronization between servers is critical to Novell Directory Services, make sure you understand time synchronization before you change the time or time zone on a server.

If you change the time on a Primary, Reference, or Single Reference server, you affect the time on other servers that use it as a time source.

Setting the time incorrectly can adversely affect the performance of Novell Directory Services. For more information, see “Monitoring and Maintaining Time Synchronization” on page 262 and “SET TIME” in *Utilities Reference*.

To set or change the date and time kept by the NetWare server’s clock, type the following at the server console prompt:

```
SET TIME [mo/day/yr] [hr:min:sec] <Enter>
```

If you don’t specify a.m. or p.m., NetWare 4.11 uses a 24-hour clock. For example, if you enter 1:00, the time is set to 1:00 a.m. If you enter 13:00, the time is set to 1:00 p.m.

## Changing the Server Time Zone



Because time synchronization between servers is critical to Novell Directory Services, make sure you understand time synchronization before you change the time or time zone on a server. Setting the time incorrectly can adversely affect the performance of Novell Directory Services.

The SET TIME ZONE command specifies the abbreviation for the local time zone and for daylight saving time. It also specifies the difference in hours between the local time zone and Coordinated Universal Time. Coordinated Universal Time (UTC) has historically been known as Greenwich Mean Time.

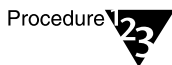
The SET TIME ZONE command does not set the time or turn daylight saving time on and off. You turn on daylight saving time and set other related parameters by using the SET command. For more information, see “SET” in *Utilities Reference*.

To display the current time zone setting, type the following at the server console prompt:

```
SET TIME ZONE <Enter>
```

## Procedure

To change the time zone information for your NetWare server, follow these steps.



### 1. At the server console prompt, type

```
SET TIME ZONE zone [+|-] hr:min:sec[daylight]  
<Enter>
```

Where

- ◆ zone is a standard three-letter abbreviation for the time zone, such as PST for Pacific Standard Time.  
  
[+|-] is the number of hours east or west of the Coordinated Universal Time (UTC) meridian. If you do not specify + or -, the system defaults to +.
- ◆ hr:min:sec indicates the time difference between UTC and the local time zone. You can specify this difference simply in hours. Or, for extreme accuracy, specify hours, minutes, and seconds.
- ◆ daylight represents a standard three-letter abbreviation for daylight saving time, such as PDT for Pacific Daylight Time.

For example, the following command line specifies PST as the standard time abbreviation, 8 as the number of hours to add to Coordinated Universal Time, and PDT as the abbreviation for daylight time:

```
SET TIME ZONE PST8PDT <Enter>
```

### 2. Change the SET TIME ZONE command in the AUTOEXEC.NCF file to the new time zone.

For more information, see “SET TIME ZONE” in *Utilities Reference*.

## Changing a Server's Name or IPX Internal Network Number

The server's name and IPX internal network number are stored in the AUTOEXEC.NCF file. You can edit this file by using INSTALL or EDIT at the server console, or by using an ASCII text editor at the workstation.

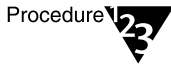


Note

This procedure requires you to reboot the NetWare server. You may want to do it after business hours or when no one is accessing the server.

To use INSTALL to change the settings, follow the procedure in this section. To use EDIT, see "Editing Text Files from the Server Console" on page 418.

### Procedure



Procedure

1. **At the server console prompt, type**

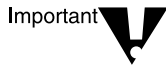
```
LOAD INSTALL <Enter>
```

2. **Choose "NCF Files Options" from the "Installation Options" menu.**
3. **Choose "Edit AUTOEXEC.NCF File" from the "NCF Files Options" menu.**
4. **Change the following lines in the file:**

```
File Server Name server_name  
IPX Internal Net net_number
```

5. **To exit and save the file, press <F10>, and then select "Yes" from the "Save file AUTOEXEC.NCF?" box.**
6. **To exit INSTALL, press <Alt>+<F10>.**
7. **Reboot the server to make the changes take effect.**

See "Bringing Down a Server" on page 405 if you need help rebooting the server.



Important

Using INSTALL to rename a server does not affect NDS™ server objects. You must use NETADMIN or NetWare Administrator to rename NetWare Server objects.

Likewise, using INSTALL to rename a volume does not affect NDS volume objects. For more information, see “Renaming Volumes” on page 473.

Be sure to update any references to the former server name in the Directory tree and in the TIMESYNC.CFG file.

## Managing Server Connections

This section explains how to enable and disable access to the server and how to monitor and solve common connection problems.

### Disabling and Enabling Logins

If you need to make repairs to the server, use the DISABLE LOGIN command to prevent users from logging in.



Note

This does not affect users who are already logged in to the network.

To reenable logins, or to enable a SUPERVISOR account when it has been locked by the intruder detection function, use ENABLE LOGIN.

For more information about these commands, see “DISABLE LOGIN” and “ENABLE LOGIN” in *Utilities Reference*.

For more information about the intruder detection function, see Table 1-7 and Table 1-9 in Chapter 1.

### Clearing a Workstation Connection

You can use either the MONITOR utility or the CLEAR STATION command to clear a connection, as described in the following sections.

Use either of these procedures to clear a workstation connection when the workstation has crashed and left open files on the server.



Note

If you clear the connection while the workstation is in the middle of a transaction or a file update, the files may be saved with incorrect data.

## Using MONITOR to Clear the Connection

### Procedure



**1. At the server console prompt, type**

`LOAD MONITOR <Enter>`

**2. Select “Connection Information” from the “Available Options” menu.**

A list of active connections appears.

**3. (Optional) To view files that are open for a workstation, highlight the connection and press <Enter>.**

After viewing files, press <Esc> to go back to the “Connection Information” screen.

**4. Clear one or more connections, as follows:**

- ◆ To clear one connection, highlight the connection and press <Delete>. At the “Clear Connection?” prompt, select “Yes.”
- ◆ To delete multiple connections, highlight each connection and press <F5> to mark it. Then press <Delete>. At the “Clear Connection?” prompt, select “Yes.”
- ◆ To clear all unused (not logged in) connections, press <F6>.

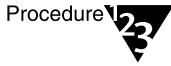
Deleted connections are no longer listed on the “Connection Information” screen.

## Using the CLEAR STATION Command to Clear the Connection

### Prerequisites



- The connection number for the workstation. You can determine the connection number by selecting “Connection Information” from the “Available Options” menu in MONITOR.



### Procedure

1. At the server console prompt, type

```
CLEAR STATION n
```

or

```
CLEAR STATION ALL <Enter>
```

Replace *n* with the connection number of the workstation, or use the “ALL” parameter to clear all connections.

### Additional Information

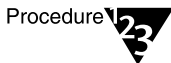
For more information about	See
Connection numbers	“Connection number” in <i>Concepts</i>
Using the CLEAR STATION command	“CLEAR STATION” in <i>Utilities Reference</i>
Using the MONITOR utility	“MONITOR” in <i>Utilities Reference</i>

## Monitoring Workstation Connections

Use this procedure for early warning that a workstation connection has become inactive. This procedure changes the SET watchdog parameters, which a server sends to a workstation to determine if the workstation connection is still active.

When the parameters are set to the values specified in the following procedure, the server sends 20 watchdog packets (twice the default value) but sends them in the shortest time allowed. If there is no response from the workstation, the server disconnects the workstation and displays an alert on the console.

### Procedure



1. At the server console prompt, load either **SERVMAN** or **MONITOR**.

```
LOAD SERVMAN | MONITOR <Enter>
```



You can also set parameters with the SET command. See “SET” in *Utilities Reference*.

2. Choose “Server Parameters” from the “Available Options” menu.
3. Choose “Communications” from the “Categories” menu.
4. Change the following watchdog parameters to the indicated values:

Number of Watchdog Packets=20

Delay Between Watchdog Packets=10

Delay Before First Watchdog Packet=16

Console Display Watchdog Logouts=ON

5. Press <Esc> twice to reach the “Update Options” menu.
6. Choose “Update AUTOEXEC.NCF and STARTUP.NCF Now” from the “Update Options” menu.

A window appears, indicating the path to the AUTOEXEC.NCF file.

7. If desired, press <Enter> to update the file.

The system writes the parameters to the AUTOEXEC.NCF file or updates the parameters if they are already in the file.

If you do not update the AUTOEXEC.NCF file, the parameter changes last only until the server is rebooted.

### Additional Information

For more information about	See
Watchdog packets	“Watchdog” in <i>Concepts</i>
SET parameters	“SET” in <i>Utilities Reference</i>
Using SERVMAN to set parameters	“SERVMAN” in <i>Utilities Reference</i>



## Increasing the Maximum Number of Packet Receive Buffers

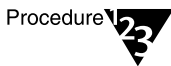
Packet receive buffers store incoming data packets until they can be processed by the server.

You should increase the maximum number of packet receive buffers only if the server is running out of buffers. The server is running out of buffers if it is

- ◆ Slowing down and losing workstation connections
- ◆ Receiving “No ECB available count” errors

The “General Information” window of MONITOR displays the total number of currently allocated packet receive buffers.

### Procedure



1. **At the server console prompt, load either `SERVMAN` or `MONITOR`.**

```
LOAD SERVMAN | MONITOR <Enter>
```



You can also set parameters with the SET command. See “SET” in *Utilities Reference*.

2. **Choose “Server Parameters” from the “Available Options” menu.**
3. **Choose “Communications” from the “Categories” menu.**
4. **Choose “Maximum Packet Receive Buffers.”**
5. **Increase the value of this parameter and press <Enter>.**

A good rule of thumb is to set this value to twice the size of the Minimum Packet Receive Buffer value.

For other suggestions, see the discussion of the Maximum Packet Receive Buffer parameter under “SET” in *Utilities Reference*.

6. **Press <Esc> twice to reach the “Update Options” menu.**

7. Choose “Update AUTOEXEC.NCF and STARTUP.NCF Now” from the “Update Options” menu.

You are prompted to update the STARTUP.NCF file.

8. If the SET parameter is in the STARTUP.NCF file, press <Enter> to update the value in the file. Otherwise press <Esc>.

You are prompted to update the AUTOEXEC.NCF file.

9. If desired, press <Enter> to update the value in the file. Otherwise, press <Esc>.

If you press <Enter> to update the file, the system writes the parameters to the AUTOEXEC.NCF file or updates the parameters if they are already in the file.

## Increasing the Minimum Number of Packet Receive Buffers

The operating system allocates a minimum number of packet receive buffers as soon as the server boots. The minimum number is specified by the Minimum Packet Receive Buffer SET parameter.

Refer to the Packet Receive Buffer value in the “General Information” window of MONITOR to determine how many buffers the server is currently allocating.

Use the following procedure to increase the minimum number of packet receive buffers if

- ◆ The allocated number is higher than 10 and the server doesn’t respond immediately after booting
- ◆ The “No ECB available” count in MONITOR grows continuously.

### Procedure



1. At the server console prompt, load either SERVMAN or MONITOR.

`LOAD SERVMAN | MONITOR <Enter>`



You can also set parameters with the SET command. See “SET” in *Utilities Reference*.

2. **Choose “Server Parameters” from the “Available Options” menu.**
3. **Choose “Communications” from the “Categories” menu.**
4. **Choose “Minimum Packet Receive Buffers.”**
5. **Increase the value of this parameter.**

As a rule of thumb, allocate at least two packet receive buffers for each workstation connection.

For other suggested settings, see the discussion of the Minimum Packet Receive Buffer parameter under “SET” in *Utilities Reference*.



The Minimum Packet Receive Buffers value should be smaller than the Maximum Packet Receive Buffers value. If it is greater than the maximum value, the system changes the maximum value to match the minimum value.

6. **Press <Esc> twice to reach the “Update Options” menu.**
7. **Choose “Update AUTOEXEC.NCF and STARTUP.NCF Now” from the “Update Options” menu.**

A window appears, indicating the path to the STARTUP.NCF file.

8. **Press <Enter> to update the file.**

The system places the parameter in the STARTUP.NCF file the next time the server boots. The parameter can be set only in the STARTUP.NCF file.

9. **When you want the changes to take effect, reboot the server.**

## **Avoiding Bottlenecks During Peak Usage**

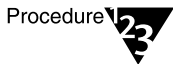
Use this procedure if your server is slow to respond during periods of heavy use.

This procedure decreases the value of the New Packet Receive Buffer Wait Time SET parameter, which specifies how long the server must wait before granting a new packet receive buffer. By decreasing the

value of this parameter you cause the system to grant buffers more quickly.

You may also want to increase the value of the Minimum Packet Receive Buffers parameter. “Increasing the Minimum Number of Packet Receive Buffers” on page 436.

### Procedure



1. **At the server console prompt, load either `SERVMAN` or `MONITOR`.**

```
LOAD SERVMAN | MONITOR <Enter>
```



You can also set parameters with the `SET` command. See “`SET`” in *Utilities Reference*.

2. **Choose “Server Parameters” from the “Available Options” menu.**
3. **Choose “Communications” from the “Categories” menu.**
4. **Choose “New Packet Receive Buffer Wait Time.”**
5. **Decrease the value of this parameter and press <Enter>.**
6. **Press <Esc> twice to reach the “Update Options” menu.**
7. **Choose “Update `AUTOEXEC.NCF` and `STARTUP.NCF` Now” from the “Update Options” menu.**

A window appears, indicating the path to the `AUTOEXEC.NCF` file.

8. **If desired, press <Enter> to update the file.**

If you press <Enter>, the system writes the parameter to the `AUTOEXEC.NCF` file or updates the parameter if it is already in the file. The file is updated immediately. You do not need to reboot the server.

If you do not press <Enter>, the parameter change lasts only until you reboot the server.

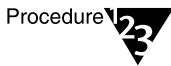
# Monitoring and Optimizing the Server

This section describes how to prevent server problems that involve memory management, CPU utilization, process scheduling, and LAN traffic. There are also procedures to help improve server performance.

## Assessing Server RAM

One of the most common causes of a slow network is insufficient Random Access Memory (RAM) in the NetWare server. This procedure helps you determine if your server has enough RAM.

### Procedure



**At the server console prompt, type**

```
LOAD MONITOR <Enter>
```

- 9. Choose “Cache Utilization” from the “Available Options” menu.**
- 10. Write down the percentage of Long Term Cache Hits shown in the lower window of the screen.**

Tracking cache hits helps you predict when you need more RAM before you experience serious performance loss.

If the percentage of Long Term Cache Hits falls below 90 percent, add more RAM to the server.

- 11. (Optional) To temporarily free up RAM, unload any NLM programs that are not critical.**
- 12. To exit MONITOR, press <Esc>, or to return to the console prompt without exiting MONITOR, press <Alt>+<Esc>.**

## Additional Information

For more information about	See
Cache buffers	“Cache buffer” in <i>Concepts</i>
MONITOR utility	“MONITOR” in <i>Utilities Reference</i>

## Controlling Memory Allocation

This procedure explains how to limit the amount of memory available for file and directory caching, thus making more memory available for NetWare Loadable Module™ (NLM) programs and server processes. Use this procedure if you receive “insufficient memory” alerts when trying to load NLM™ programs.

To solve memory problems without limiting memory for file and directory caching, add more memory.

### Procedure



1. **At the server console prompt, load either `SERVMAN` or `MONITOR`.**

```
LOAD SERVMAN | MONITOR <Enter>
```



You can also set parameters with the `SET` command. See “`SET`” in *Utilities Reference*.

2. **Choose “Server Parameters” from the “Available Options” menu.**
3. **Choose “File Caching” from the “Categories” menu.**
4. **Choose “Minimum File Cache Buffers.”**

This parameter specifies the minimum amount of memory the system will keep for file caching. Memory above this minimum amount is available for other processes.

5. **Reduce the value of this parameter.**
6. **Press <Esc> twice to reach the “Categories” menu.**
7. **Choose “Directory Caching” from the “Categories” menu.**

**8. Choose “Maximum Directory Cache Buffers.”**

This parameter specifies the maximum number of buffers that can be allocated for directory caching. Once allocated, the buffers remain allocated, even if they are not being used. Thus, they are not available for other processes.

By reducing this parameter, you prevent the system from allocating too many directory cache buffers and you ensure that more memory is available for other server processes.



Reducing the maximum number of directory cache buffers may impede system performance.

**9. Reduce the value of the “Maximum Directory Cache Buffers” parameter.**

**10. Press <Esc> twice to reach the “Update Options” menu.**

**11. Choose “Update AUTOEXEC.NCF and STARTUP.NCF Now” from the “Update Options” menu.**

A window appears, indicating the path to the AUTOEXEC.NCF file.

**12. Press <Enter> to update the file.**

When you press <Enter>, the system writes the parameters to the AUTOEXEC.NCF file or updates the parameters if they are already in the file.

**13. Reboot the server to free the memory.**

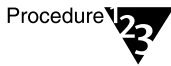
## Speeding Directory Searches

Use this procedure if the server responds slowly to directory searches.



This procedure requires you to increase the number of directory cache buffers that can be allocated by the system. Memory allocated for directory cache buffers is no longer available for use by other processes.

### Procedure



1. **At the server console prompt, load either `SERVMAN` or `MONITOR`.**

```
LOAD SERVMAN | MONITOR <Enter>
```



You can also set parameters with the `SET` command. See “`SET`” in *Utilities Reference*.

2. **Choose “Server Parameters” from the “Available Options” menu.**
3. **Choose “Directory Caching” from the “Categories” menu.**
4. **Select “Directory Cache Allocation Wait Time.”**

This parameter specifies how long the system must wait after allocating one directory cache buffer before it can allocate another buffer. If the value is too high, directory searches are slow.

5. **Decrease the value of this parameter.**
6. **Select “Maximum Directory Cache Buffers.”**

This parameter specifies the maximum number of cache buffers the system can allocate for directory caching. If the number is too low, directory searches are slow.

7. **Increase the value of this parameter.**
8. **Select “Minimum Directory Cache Buffers.”**

This parameter specifies the minimum number of directory cache buffers the system allocates. If the number is too low, directory searches are slow.

9. **Increase the value of this parameter.**



10. Press <Esc> twice to reach the “Update Options” menu.
11. Choose “Update AUTOEXEC.NCF and STARTUP.NCF Now” from the “Update Options” menu.

A window appears, indicating the path to the AUTOEXEC.NCF file.

12. If desired, press <Enter> to update the file.

If you press <Enter>, the system writes the parameters to the AUTOEXEC.NCF file or updates the parameters if they are already in the file. The file is updated immediately. You do not need to reboot the server.

If you do not press <Enter>, the parameter changes last only until you reboot the server.

## Prioritizing Server Processes

You can use SCHDELAY to prioritize server processes. SCHDELAY allows you to delay the execution of specific processes, thereby giving more CPU time—and higher priority—to other processes.

The command syntax is

```
LOAD SCHDELAY process_name = number [process_name =  
number] <Enter>
```

The *process name* value is the name of a process or thread that accesses the server CPU. You can specify the process value for multiple processes at one time.

To view the list of processes that can be prioritized, along with their current SCHDELAY values, type

```
LOAD SCHDELAY <Enter>
```

The *number* value determines how many times the process delays execution. A value of 0 causes no delay, while a value of 2 skips every other execution of the process.

To delay a process, you can enter a value from 2 to 10000—the higher the value, the lower the priority of the process.



Note

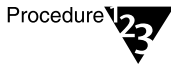
The SCHDELAY values only have an effect if the system is busy and two or more processes are vying for the CPU's time.

For example, if you want to assign a database NLM called DBNLM a lower priority than other processes so it won't monopolize the NetWare server's CPU, put a command similar to the following in the AUTOEXEC.NCF file:

```
LOAD SCHDELAY DBNLM = 2
```

To view the list of processes and determine which processes are hoarding CPU time, follow this procedure.

### Procedure



Procedure

**At the server console prompt, type**

```
LOAD MONITOR <Enter>
```

#### **13. Select "Scheduling Information" from the "Available Options" menu.**

A list of server processes appears, with four columns of information about each process.

- ◆ The "Sch Delay" column shows the current SCHDELAY value assigned to the process. The default is 0.
- ◆ The "Time" column shows the CPU time spent executing the process code.
- ◆ The "Count" column shows how many times the process ran during the sample period. (The "Total Sample Time" is displayed at the bottom of the screen.)
- ◆ The "Load" column shows the percent of total CPU time spent on the process.

#### **14. Select a process that has a high number in the "Load" column.**

Look for processes that have consistently high values, rather than high peak values.

15. Use the plus (+) or minus (–) key to increase or decrease the SCHDELAY value for the selected process.

The value in the “Load” column changes accordingly.

16. Experiment with higher or lower SCHDELAY values until the CPU load, as displayed in the “Load” column, is within acceptable limits.

What is acceptable depends upon your system and your needs. The goal is to balance the load so that processes run to your satisfaction.



To make the SCHDELAY value effective each time the server boots, put the SCHDELAY command in the AUTOEXEC.NCF file.

17. To exit the scheduling information window, press <Esc>.

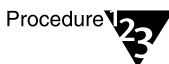
You do not need to reboot the server.

## Checking a Server’s Processor Utilization

One possible cause of network problems is the monopolizing of the CPU by a single process. This procedure helps you determine which processes are using the CPU and how much load they are putting on the CPU’s time.

For information about processor utilization in a multiprocessing server, see Chapter 8, “Maintaining NetWare SMP,” on page 563.

### Procedure



At the server console prompt, type

```
LOAD MONITOR <Enter>
```

18. Choose “Processor Utilization” from the “Available Options” menu.

**19. Press <F3> to view a list of the currently loaded processes and interrupts.**

For each item on the list, notice the percentage given in the “Load” column. This is the percentage of time the CPU spent servicing this process during the one-second sample period.

Compare processes to determine which processes are taking the most CPU time.

**20. (Optional) To redistribute processor utilization, you can do either or both of the following:**

- ◆ Unload noncritical NLM programs that are taking a large percentage of CPU time.
- ◆ Assign processes a lower priority, using SCHDELAY. For more information, see “Prioritizing Server Processes” on page 443.

## **Viewing a Server’s Packet Traffic**

You can view the packet traffic coming in and going out of the server by using TRACK ON at the server console prompt. Use TRACK OFF to stop viewing the packet traffic.

See “TRACK ON” and “TRACK OFF” in *Utilities Reference* for more information about these commands.

## Viewing LAN Driver Statistics

Reviewing the LAN driver statistics on your server can help you regulate network traffic and troubleshoot system problems.

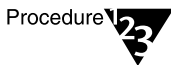
For example, you can use the LAN driver statistics to determine

- ◆ The total traffic since the LAN driver was loaded
- ◆ Which drivers handle the most traffic
- ◆ The frequency of various errors

Many statistics count the instances of a particular error. For example, the Send Packet Retry Count statistic indicates how many times the server tried to send a packet but failed because of a hardware problem.

The number and kinds of statistics available depend on the LAN drivers installed on your system. Follow this procedure to view the statistics.

### Procedure



**At the server console prompt, type**

```
LOAD MONITOR <Enter>
```

21. **Select “LAN/WAN Information” from the “Available Options” menu.**
22. **Select a LAN driver from the “LAN Driver Information” menu.**

The statistics for the selected LAN driver are displayed. Press <PageUp> and <PageDown> to scroll through the information in the window. For an explanation of the statistics, see Appendix A, “LAN Driver Statistics,” of *Utilities Reference*.

# Improving Server Performance

You can increase server performance two ways:

- ◆ By using magneto-optical media to extend server storage capacity. Such storage enables the server to migrate seldom-used files from the hard disk, freeing space needed by other files and processes.

For procedures related to magneto-optical media, see Chapter 6, “Migrating Data Using the High Capacity Storage System,” on page 351.

- ◆ By increasing the size of the packets received by the server.

The method of increasing packet size is explained in the following procedure.



Note

Use this procedure only if the network boards in your server can transmit more than 512 bytes of data per packet. Refer to the documentation that came with the network boards to determine the packet size.

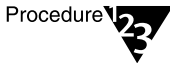
## Prerequisites



Checklist

- Large-packet network boards installed in the server. Refer to the documentation that comes with the boards to determine the available packet size.

## Procedure



Procedure

1. **At the server console prompt, load either `SERVMAN` or `MONITOR`.**

```
LOAD SERVMAN | MONITOR <Enter>
```



Note

You can also set parameters with the `SET` command. See “`SET`” in *Utilities Reference*.

2. **Choose “Server Parameters” from the “Available Options” menu.**
3. **Choose “Communications” from the “Categories” menu.**
4. **Choose “Maximum Physical Receive Packet Size” from the “Communications” menu.**
5. **Increase the value and press <Enter>.**

Refer to the documentation that comes with the boards to determine the maximum value.

6. Press <Esc> twice to reach the “Update Options” menu.
7. Choose “Update AUTOEXEC.NCF and STARTUP.NCF Now” from the “Update Options” menu.

A window appears, indicating the path to the STARTUP.NCF file.

8. Press <Enter> to update the file.
9. When you want the changes to take effect, reboot the server.

## Improving Disk Writes

The following sections describe methods for improving the speed of disk writes.

### Increasing the Number of Concurrent Writes

You can increase the speed and efficiency of disk cache writes by increasing the number of write requests that can be executed at one time.

To determine if you need to increase the number of concurrent writes, first compare the number of dirty cache buffers to the total number of cache buffers. Dirty cache buffers contain data that has not yet been written to disk. These statistics are found on the “General Information” screen in MONITOR.

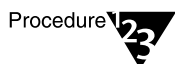
If the number of dirty cache buffers is greater than 70 percent of total cache buffers, use the following procedure to increase the number of concurrent write requests.

For an explanation of file caching and dirty cache buffers, refer to “Cache memory” in *Concepts*.



Increasing the number of concurrent disk cache writes slows disk cache reads. You will want to balance the speed of disk writes and reads to meet your own needs.

## Procedure



1. **At the server console prompt, load either `SERVMAN` or `MONITOR`.**

```
LOAD SERVMAN | MONITOR <Enter>
```



You can also set parameters with the `SET` command. See “`SET`” in *Utilities Reference*.

2. **Choose “Server Parameters” from the “Available Options” menu.**
3. **Choose “File Caching” from the “Categories” menu.**
4. **Choose “Maximum Concurrent Disk Cache Writes” from the “File Caching” menu.**
5. **Increase the parameter value and press <Enter>.**

If the parameter is currently at the default value of 50, try increasing it to 100.

6. **Press <Esc> twice to reach the “Update Options” menu.**
7. **Choose “Update `AUTOEXEC.NCF` and `STARTUP.NCF` Now” from the “Update Options” menu.**

A window appears, indicating the path to the `AUTOEXEC.NCF` file.

8. **If desired, press <Enter> to update the file.**

If you press <Enter>, the system writes the parameter to the `AUTOEXEC.NCF` file or updates the parameter if it is already in the file. The file is updated immediately. You do not need to reboot the server.

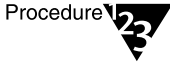
If you do not press <Enter>, the parameter change lasts only until you reboot the server.



## Changing Disk and Directory Caching for Faster Writes

Use this procedure if network users frequently make many small write requests and the server is slow to respond to the requests.

### Procedure



1. **At the server console prompt, load either `SERVMAN` or `MONITOR`.**

```
LOAD SERVMAN | MONITOR <Enter>
```



You can also set parameters with the `SET` command. See “`SET`” in *Utilities Reference*.

2. **Choose “Server Parameters” from the “Available Options” menu.**
3. **Choose “File Caching” from the “Categories” menu.**
4. **Choose “Dirty Disk Cache Delay Time” from the “File Caching” menu.**
5. **Increase the value and press <Enter>.**

This parameter specifies how long the system waits before writing a not-completely-dirty cache buffer to disk.

If the value is low, the system writes to disk more frequently, but writes fewer requests each time. If the value is high, the system waits longer before writing to disk, but executes more write requests with each operation. A higher value provides greater efficiency in writing to disk.

If the parameter is currently at the default value of 3.3 seconds, try increasing the value to 7 seconds.

6. **Press <Esc> to reach the “Categories” menu.**
7. **Choose “Directory Caching” from the “Categories” menu and press <Enter>.**

**8. Choose “Dirty Directory Cache Delay Time.”**

This parameter specifies how long the system keeps a directory table write request in memory before writing it to disk.

Increasing the parameter provides slightly faster performance, but may increase the chance of directory tables becoming corrupted.

**9. Increase the value and press <Enter>.**

If the parameter is currently at the default value of 0.5 second, try increasing the value to 2 seconds.

**10. Choose “Maximum Concurrent Directory Cache Writes.”**

This parameter determines how many write requests from directory cache buffers are executed at one time. Increasing this value increases the efficiency of directory cache write requests.



Increasing the number of concurrent directory cache writes decreases the speed of directory cache reads. You will want to balance the speed of writes and reads to meet your own needs.

**11. Increase the value and press <Enter>.**

If the parameter is currently at the default value of 10, try increasing the value to 25.

**12. Press <Esc> twice to reach the “Update Options” menu.**

**13. Choose “Update AUTOEXEC.NCF and STARTUP.NCF Now” from the “Update Options” menu.**

A window appears, indicating the path to the AUTOEXEC.NCF file.

**14. If desired, press <Enter> to update the file.**

If you press <Enter>, the system writes the parameters to the AUTOEXEC.NCF file or updates the parameters if they are already in the file. The file is updated immediately. You do not need to reboot the server.

If you do not press <Enter>, the parameter changes last only until you reboot the server.

## Turning Off Read-After-Write Verification

Read-after-write verification is an important means of protecting the data on your system. Normally, you should not disable it.

However, if your disks are mirrored and reliable, you may choose to disable read-after-write verification because disabling almost doubles the speed of disk writes.



Turning off read-after-write verification may increase the risk of data corruption on the server's hard disk. You should use the following procedure only if your disks are mirrored and reliable, and you understand the risk.



### Prerequisites

- Mirrored hard disks



### Procedure

- 1. At the server console prompt, type**  
`LOAD MONITOR <Enter>`
- 2. Choose “Disk Information” from the “Available Options” menu and press <Enter>.**
- 3. Select a disk drive from the “System Disk Drives” menu.**
- 4. Select “Read After Write Verify” from the “Driver Status” menu.**
- 5. Select “Disable Verify” from the “Read After Write Status” menu.**



You can also disable read-after-write verification by setting the Enable Disk Read After Write Verify SET parameter to OFF. However, this setting only affects those disks loaded after the parameter value is changed. It does not change the setting for currently loaded disks.

# Improving Disk Reads

The following sections describe methods for improving the speed of disk reads.

## Changing Concurrent Disk and Directory Writes for Faster Reads

Use this procedure if your server is slow to respond to read requests.



Note

This procedure requires you to decrease the values of the Maximum Concurrent Disk Cache Writes parameter and the Maximum Concurrent Directory Cache Writes parameter. Although decreasing these values increases the speed of read requests, it may decrease the speed and efficiency of write requests.

### Procedure



Procedure

1. **At the server console prompt, load either `SERVMAN` or `MONITOR`.**

```
LOAD SERVMAN | MONITOR <Enter>
```



Note

You can also set parameters with the `SET` command. See “`SET`” in *Utilities Reference*.

2. **Choose “Server Parameters” from the “Available Options” menu.**
3. **Choose “File Caching” from the “Categories” menu.**
4. **Choose “Maximum Concurrent Disk Cache Writes.”**
5. **Decrease this value and press <Enter>.**  
  
If the parameter is currently set to the default value of 50, try setting the value to 10.
6. **Press <Esc> to reach the “Categories” menu.**
7. **Choose “Directory Caching” from the “Categories” menu.**
8. **Choose “Maximum Concurrent Directory Cache Writes.”**

**9. Decrease this value and press <Enter>.**

If the parameter is currently set to the default value of 10, try setting the value to 5.

**10. Choose “Directory Cache Buffer NonReferenced Delay.”**

This parameter specifies how long a directory entry must be cached before it can be overwritten. Increasing this value causes the system to allocate more directory cache buffers and thus speeds directory access.

**11. Increase this value and press <Enter>.**

If the parameter is currently set to the default value of 5.5 seconds, try setting the value to 60 seconds.

**12. Press <Esc> twice to reach the “Update Options” menu.**

**13. Choose “Update AUTOEXEC.NCF and STARTUP.NCF Now” from the “Update Options” menu.**

A window appears, indicating the path to the AUTOEXEC.NCF file.

**14. If desired, press <Enter> to update the file.**

If you press <Enter>, the system writes the parameters to the AUTOEXEC.NCF file or updates the parameters if they are already in the file. The file is updated immediately. You do not need to reboot the server.

If you do not press <Enter>, the parameter changes last only until you reboot the server.

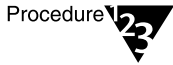
## **Changing the Turbo FAT Wait Time for Faster Reads**

When a program randomly accesses a file that contains more than 64 File Allocation Table (FAT) entries, the system builds a turbo FAT index for the file so that the information in the file can be accessed quickly.

The Turbo FAT Re-Use Wait Time parameter specifies how long a turbo FAT index remains in memory after the indexed file is closed. When the turbo FAT index is in memory, files can be opened and information accessed faster.

If network users frequently access files larger than 64 blocks, use this procedure to increase the time the index is kept in memory.

### Procedure



1. **At the server console prompt, load either `SERVMAN` or `MONITOR`.**

```
LOAD SERVMAN | MONITOR <Enter>
```



You can also set parameters with the `SET` command. See “`SET`” in *Utilities Reference*.

2. **Choose “Server Parameters” from the “Available Options” menu.**
3. **Choose “File System” from the “Categories” menu.**
4. **Select “Turbo FAT Re-Use Wait Time.”**
5. **Increase this value and press <Enter>.**

You must specify the value in seconds.

If the parameter is currently set to the default value of 329.5 seconds (5 minutes 29.6 seconds), try setting the value to 600 seconds (10 minutes).

6. **Press <Esc> twice to reach the “Update Options” menu.**
7. **Choose “Update `AUTOEXEC.NCF` and `STARTUP.NCF` Now” from the “Update Options” menu.**

A window appears, indicating the path to the `AUTOEXEC.NCF` file.

8. **If desired, press <Enter> to update the file.**

If you press <Enter>, the system writes the parameters to the `AUTOEXEC.NCF` file or updates the parameters if they are already in the file. The file is updated immediately. You do not need to reboot the server.

If you do not press <Enter>, the parameter changes last only until you reboot the server.

## Controlling Resource Allocation with Locks

A lock prevents a file or record from being updated by more than one user at a time. By controlling the number of file and record locks available to a workstation or a server, you control access to files and records.

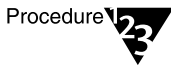
You may choose to limit the number of locks to prevent overuse of file resources. Or you may choose to increase the number of locks if workstations can't open files.

### Keeping Workstations from Overusing File Resources

If workstations are overusing file resources by opening and locking too many files or records at one time, use the following procedure to limit the number of locks for the server and for each workstation.

Before limiting file and record locks, make sure the workstations have an adequate number of locks to access the files and records they need. Limiting needed locks can cause applications to generate errors.

#### Procedure



1. **At the server console prompt, load either `SERVMAN` or `MONITOR`.**

```
LOAD SERVMAN | MONITOR <Enter>
```



You can also set parameters with the `SET` command. See “`SET`” in *Utilities Reference*.

2. **Choose “Server Parameters” from the “Available Options” menu.**
3. **Choose “Locks” from the “Categories” menu.**
4. **Decrease the following parameter values to limit the total number of file and record locks allowed for the server:**

`Maximum Record Locks`

`Maximum File Locks`

5. **Decrease the following parameter values to limit the total number of file and records locks allowed for each workstation:**

`Maximum Record Locks Per Connection`  
`Maximum File Locks Per Connection`

6. **Press <Esc> twice to reach the “Update Options” menu.**
7. **Choose “Update AUTOEXEC.NCF and STARTUP.NCF Now” from the “Update Options” menu.**

A window appears, indicating the path to the AUTOEXEC.NCF file.

8. **If desired, press <Enter> to update the file.**

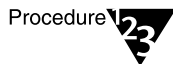
If you press <Enter>, the system writes the parameters to the AUTOEXEC.NCF file or updates the parameters if they are already in the file. The file is updated immediately. You do not need to reboot the server.

If you do not press <Enter>, the parameter changes last only until you reboot the server.

## Increasing File Record Locks

Use this procedure if applications fail because they cannot open enough files or because not enough record locks are available.

### Procedure



1. **At the server console prompt, load either SERVMAN or MONITOR.**

`LOAD SERVMAN | MONITOR <Enter>`



You can also set parameters with the SET command. See “SET” in *Utilities Reference*.

2. **Choose “Server Parameters” from the “Available Options” menu.**



3. Choose “Locks” from the “Categories” menu.
4. Increase the following parameter values to increase the number of file and record locks allowed for the server:

Maximum Record Locks

Maximum File Locks

5. Increase the following parameter values to increase the number of file and record locks allowed for each workstation:

Maximum Record Locks Per Connection

Maximum File Locks Per Connection

6. Press <Esc> twice to reach the “Update Options” menu.
7. Choose “Update AUTOEXEC.NCF and STARTUP.NCF Now” from the “Update Options” menu.

A window appears, indicating the path to the AUTOEXEC.NCF file.

8. Press <Enter> to update the file.

If you press <Enter>, the system writes the parameters to the AUTOEXEC.NCF file or updates the parameters if they are already in the file. The file is updated immediately. You do not need to reboot the server.

If you do not press <Enter>, the parameter changes last only until you reboot the server.

## Displaying Alert Messages

You can use SET parameters to control the display of alert messages on the server console.

### Turning on Hardware and NLM Alerts

To display alerts about hardware devices and NLM programs, add the following SET commands to the beginning of the STARTUP.NCF file:

```
SET Display Spurious Interrupt Alerts=ON
SET Display Lost Interrupt Alerts=ON
SET Display Relinquish Control Alerts=ON
SET Display Old API Names=ON
```

To temporarily turn off an alert message display (when it is filling up the console screen, for example), use the SET command to change the relevant parameter setting to OFF. When you reboot the server, the setting is changed to ON again.

### Turning on Early Warning Alerts for Cache Buffer Memory Allocation

All memory not allocated for other processes is given to file caching. As memory is requested for other processes, the server gives up file cache buffers. However, there is a minimum number of file cache buffers that cannot be given up. This minimum is specified by the Minimum File Cache Buffers SET parameter.

Use the following procedure to specify when the system will warn you that the number of buffers is approaching the minimum level.

#### Procedure



1. **At the server console prompt, load either SERVMAN or MONITOR.**

```
LOAD SERVMAN | MONITOR <Enter>
```



You can also set parameters with the SET command. See “SET” in *Utilities Reference*.

2. **Choose “Server Parameters” from the “Available Options” menu.**

**3. Choose “File Caching” from the “Categories” menu.**

**4. Select Minimum File Cache Buffers.**

View this parameter to learn the minimum number of file cache buffers currently set.

**5. Choose “Minimum File Cache Report Threshold” from the “File Caching” menu.**

This parameter specifies how many unused cache buffers must be left above the minimum value for the system to warn you that cache buffers are low.

**6. Change the parameter value as needed and press <Enter>.**

For example, if the Minimum File Cache Buffers parameter is set to 20 and the Minimum File Cache Report Threshold is set to 25, you are warned when all but 45 cache buffers are allocated for other processes.

**7. Press <Esc> twice to reach the “Update Options” menu.**

**8. Choose “Update AUTOEXEC.NCF and STARTUP.NCF Now” from the “Update Options” menu.**

A window appears, indicating the path to the AUTOEXEC.NCF file.

**9. If desired, press <Enter> to update the file.**

If you press <Enter>, the system writes the parameter to the AUTOEXEC.NCF file or updates the parameter if it is already in the file. The file is updated immediately. You do not need to reboot the server.

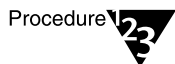
If you do not press <Enter>, the parameter change lasts only until you reboot the server.

## Turning on Early Warning Alerts for a Full Volume

Use this procedure to enable early warning that a volume is nearly full.

If a volume is becoming full, you may need to remove unnecessary files or add a new hard disk.

### Procedure



1. **At the server console prompt, load either `SERVMAN` or `MONITOR`.**

```
LOAD SERVMAN | MONITOR <Enter>
```



You can also set parameters with the `SET` command. See “`SET`” in *Utilities Reference*.

2. **Choose “Server Parameters” from the “Available Options” menu.**
3. **Choose “File System” from the “Categories” menu.**
4. **Select “Volume Low Warn All Users” and change the value to `ON`.**

This causes the system to send a warning message to users when a volume is becoming full. The next two steps specify when the warning is sent and when it is removed.

5. **Select “Volume Low Warning Threshold” and set it to the desired value.**

This parameter determines when the system will warn users that the volume is becoming full.

The threshold specifies how much free space, in blocks, must be left on the volume for the warning to be issued.

6. **Select “Volume Low Warning Reset Threshold” and set it to the desired value.**

This parameter determines when the warning will be removed.

It specifies the amount of space that must be freed on the volume for the warning message to be cleared and the warning mechanism to be reset.

For example, both the Volume Low Warning Threshold and the Volume Low Warning Reset Threshold might be set to 256 blocks. In this case, the system sends a warning when 256 blocks of free space is left on the volume. The volume must then gain an additional 256 blocks (for a total of 512 blocks of free space) before the warning message disappears and the warning mechanism is reset.

Once the mechanism is reset, the free space on the volume must dip below 256 blocks again before another warning is sent.

7. **Press <Esc> twice to reach the “Update Options” menu.**
8. **Choose “Update AUTOEXEC.NCF and STARTUP.NCF Now” from the “Update Options” menu.**

A window appears, indicating the path to the AUTOEXEC.NCF file.

9. **Press <Enter> to update the file.**

If you press <Enter>, the system writes the parameters to the AUTOEXEC.NCF file or updates the parameters if they are already in the file. The file is updated immediately. You do not need to reboot the server.

If you do not press <Enter>, the parameter changes last only until you reboot the server.

## Viewing the Server Error Log

The server error log is a text file called `SYSSLOG.ERR` in the server's `SYS_servername:SYSTEM` directory. All system messages and alerts that appear on the server console are recorded in the `SYSSLOG.ERR` file. You should view this file periodically to see what kinds of errors are occurring on your server.

NetWare security violations are also recorded in the `SYSSLOG.ERR` file. Check this file daily if you are concerned about security at your site.



You should regularly clear the `SYSSLOG.ERR` file to keep it from using too much server disk space.

You can view the server error log from a workstation using a text editor or from the console using `EDIT.NLM`. For more information about using `EDIT`, see “Editing Text Files from the Server Console” on page 418.

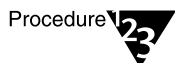
You can also view or clear the server error log with the `NETADMIN` and `FILER` utilities, as described here.

### Prerequisites



- A workstation running DOS 3.30 or later.
- A minimum of 512 KB of memory available on the workstation.
- Supervisor or equivalent directory right to `SYS:SYSTEM`.

### Procedure for `NETADMIN`



1. **At the workstation prompt, type**  
`NETADMIN` <Enter>
2. **From the “NetAdmin Options” screen, choose “Manage Objects.”**
3. **From the browser, select the Server object whose error file you want to view and press <F10>.**
4. **Choose “View or Edit Properties of This Object.”**
5. **Choose “View Server Error Log File.”**  
The server error log appears.
6. **To delete or exit the server error log, press <Esc>.**  
A prompt to clear the error log file appears.
7. **To clear the error log file, choose “Yes.”**
8. **To exit `NETADMIN`, press <Alt>+<F10>.**



## Procedure for FILER

1. **At the workstation prompt, type**  
  
`FILER <Enter>`
2. **From the “Available Options” screen, choose “Manage Files and Directories.”**
3. **From the “Directory Contents” screen, browse the tree to select the SYS: volume on the Server object whose error file you want to view, and press <F10>.**
4. **Choose the error log file you want to view.**
5. **From the “File Options” screen, choose “View File.”**  
  
The server error log appears.
6. **To exit the server error log, press <Esc> twice.**
7. **To clear the error log file, be sure the correct filename is highlighted and press <Delete>**  
  
A prompt to clear the error log file appears.
8. **To clear the error log file, choose “Yes.”**
9. **To exit FILER, press <Alt>+<F10>.**

## Managing Error Log Files

NetWare creates and maintains three error log files:

- ◆ `SYSSLOG.ERR`, for server errors
- ◆ `VOL$LOG.ERR`, for volume errors
- ◆ `TTSSLOG.ERR`, for data backed out by the Transaction Tracking System™

To keep error log files from using too much disk space, NetWare 4 includes the following SET parameters:

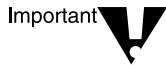
```
SET Server Log File State
SET Server Log File Overflow Size
SET Volume Log File State
SET Volume Log File Overflow Size
SET Volume TTS Log File State
SET Volume TTS Log File Overflow Size
```

See “SET” in *Utilities Reference* for information on using these parameters to limit error log file size.

## Checking for Disk Errors

You should check for disk errors regularly. Any new errors should be cause for concern, because such errors can lead to a failed file system and loss of data.

If you check for disk errors regularly, you can replace a disk before it causes data loss.



If your server's disk drive performs read-after-write verification and automatically redirects bad blocks, the following procedure does not work. It only works if NetWare does the redirection, using Hot Fix™.

### Procedure



1. **At the server console prompt, type**

```
LOAD MONITOR <Enter>
```

2. **Choose “Disk Information” from the “Available Options” menu.**
3. **Choose the disk drive you want to check from the “System Disk Drives” menu.**

The upper part of the screen displays information about the disk device that you selected, including Hot Fix and Redirected Block statistics.



- 4. Write down the number of Redirected Blocks and the number of Redirection Blocks shown in the upper window of the screen.**

When NetWare cannot reliably write a block of data to the disk, it marks the disk block as bad and writes the data to the Hot Fix Redirection Area.

The Redirected Blocks count shown in MONITOR is the number of blocks redirected since the server was installed.

The Redirection Blocks count is the number of blocks designated as the Hot Fix Redirection Area.

- 5. Evaluate these statistics and proceed according to the following steps.**
  - 5a. Compare the current number of redirected blocks to the number you recorded the last time you checked this number.**

If the number of redirected blocks is the same as the previously noted number, you do not need to take any corrective action.

If the number of redirected blocks has increased significantly, or if the number of redirected blocks is over half the number of redirection blocks, continue with Step 5b.

If the number of redirected blocks has slightly increased over the previous number, monitor the server closely.
  - 5b. Send a message to all users to close files and log out.**
  - 5c. Back up the server data and bring down the server.**
  - 5d. Troubleshoot the disk drive, driver, controller, and host bus adapter, using the hardware documentation.**

## Additional Information

For more information about	See
Data protection	"Data protection" in <i>Concepts</i>
MONITOR utility	"MONITOR" in <i>Utilities Reference</i> Online help in MONITOR
Redirection, Hot Fix, and read-after-write verification	"Hot Fix" in <i>Concepts</i>

## Maintaining Volumes

This section describes how to create, delete, rename, mount, dismount, and repair NetWare volumes. It also includes procedures for adding volume segments and changing volume size.

In Novell Directory Services, each volume is also an object in the Directory. When you create a volume with INSTALL.NLM, it puts a Volume object in the same context as the NetWare Server object within the Directory tree. By default, INSTALL names the Volume object *servername\_volumename*.

You can change the context of Volume objects and rename Volume objects with either the NETADMIN text utility or the NetWare Administrator graphical utility.



To rename or delete a volume, you must use INSTALL to rename or delete the volume on the server, and then use NETADMIN or NetWare Administrator to change the Volume object in the Directory.

# Creating Volumes

With NetWare 4.11, you can create a new volume on any hard disk that has a NetWare 4.11 partition.

You use INSTALL to create volumes.

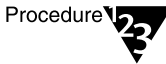
Your NetWare server can have from 1 to 64 NetWare volumes, depending on the needs of your users. NetWare requires only one volume, SYS:.

## Prerequisites



- A NetWare partition on the disk where you want to create the volume
- An existing volume SYS:

## Procedure



1. **At the server console prompt, type**  
`LOAD INSTALL <Enter>`
2. **From the “Installation Options” menu, choose “Volume Options.”**

If any volumes exist, they are now listed.

3. **Press <Insert>.**

The “Volume Disk Segment List” is displayed.

4. **Select any existing free space and press <Enter>.**

Free space is any NetWare disk partition space to which no volume assignment has been made.



By default, a new volume takes up all remaining free space of a NetWare disk partition when it is created. However, you can decrease the volume size to leave some free space on the partition for adding NetWare volumes in the future.

If no free space is available, you must add a new hard disk, or add magneto-optical disk storage, before you can create new volumes.

5. **Type a new volume name in the box provided and press <Enter>.**

The volume name can be up to 15 characters long (A through Z, 0 through 9, and underscore characters are allowed).

The newly created volume now appears in the “Volume Disk Segment List.”

If you want the new volume to use all of the free disk space, skip to Step 7. If not, continue with Step 6.

6. **If you don't want the new volume to use all of the free disk space, do the following:**
  - 6a. **Select the volume you just created and press <Enter>.**
  - 6b. **Enter a new volume size, expressed in megabytes (MB), and press <Enter>.**
  - 6c. **Press <Esc> and save the settings.**
  - 6d. **To assign the free space you just created to another volume, repeat Step 4 and Step 5.**
  - 6e. **Skip to Step 9.**
7. **If you want the new volume to use all of the free disk space, either press <Esc> to continue with other volume tasks or press <F10> to save volume information to disk.**
8. **From the menu, choose “Mount/Dismount an Existing Volume.”**
9. **Choose “Mount.”**

#### **Additional Information**

---

<b>For more information about</b>	<b>See</b>
Creating NetWare disk partitions	“Creating NetWare Disk Partitions” on page 511
Changing the size of a volume	“Modifying the Size of a Volume” on page 482

---

For more information about	See
Adding a hard disk	“Loading Disk Drivers” on page 508
Adding magneto-optical disk storage	Chapter 6, “Migrating Data Using the High Capacity Storage System,” on page 351

## Mounting and Dismounting Volumes

By mounting a volume, you make its information available to network users. You can mount or dismount one or all volumes while the NetWare server is running.

You may want to leave rarely used volumes dismounted because each mounted volume takes up memory and reduces the memory available for file caching.

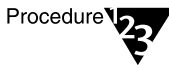
You can mount and dismount volumes in two ways:

- ◆ Use the MOUNT and DISMOUNT console commands. (See “MOUNT” and “DISMOUNT” in *Utilities Reference*.)
- ◆ Use INSTALL as described in the following procedure.



To mount CD-ROM volumes, use the CD command. For more information, see “Using a CD-ROM as a NetWare Volume” on page 483.

### Procedure



**At the server console prompt, type**

```
LOAD INSTALL
```

- 10. Select the volume you want to mount or dismount and press <Enter>.**

The “Volume Information” screen is displayed.

- 11. Using the arrow keys, highlight the “Status” field.**

Depending on the status of the volume, this field displays “Mounted,” “Not Mounted,” or “New, not mounted.”

12. If the status is “New, not mounted,” press <Esc> and then <F10> to save volume changes to disk before the volume can be mounted.
13. Press <Enter> to display a menu of available actions.
14. Depending on your situation, select either “Mount” or “Dismount” and press <Enter>.

NetWare mounts or dismounts your volume.



If volumes fail to mount, you may not have enough RAM installed to accommodate the volume. For more information, see “Assessing Server RAM” on page 439.

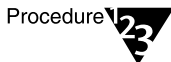
## Deleting Volumes



Deleting one volume segment deletes all existing data on the volume! You cannot delete only part of a volume.

This procedure tells you how to delete an entire volume.

### Procedure



1. If the volume you want to delete contains HCSS directories, unload the HCSS media. For information on unloading the media, see “Reformatting Media” on page 383.
2. Back up the data stored on the volume you want to delete.
3. Dismount the volume you want to delete.

At the server console prompt, type

```
LOAD INSTALL <Enter>
```

4. From the “Installation Options” menu, choose “Volume Options” and press <Enter>.

A list of existing volumes is displayed.

5. **From the list of existing volumes, select the volume you want to delete and press <Delete>.**

A warning similar to the following appears:

```
Volume volume_name may contain valuable data that
will be lost if you confirm "Yes" in the box that
follows this message and if you save volume
changes on exit from the volumes list.
<Press ENTER to continue>
```

6. **Press <Enter> if you want to continue.**
7. **When the "Delete existing volume?" prompt appears, select "Yes" and press <Enter>.**



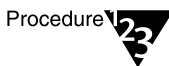
Deleting volumes with INSTALL does not affect Volume *objects*. You must use NETADMIN or NetWare Administrator to delete Volume objects.

### Additional Information

For more information about	See
HCSS volumes	Chapter 6, "Migrating Data Using the High Capacity Storage System," on page 351
Backing up a volume	Chapter 9, "Backing Up and Restoring Data," on page 591
Deleting NDS Volume objects	"Deleting Objects from the Directory Tree" on page 78
Using NWADMIN to delete a volume	"Deleting Objects Using NetWare Administrator" on page 81
Using the NetWare Administrator to delete a volume	"Deleting Objects Using NETADMIN" on page 82

## Renaming Volumes

### Procedure



1. **Dismount the volume you want to rename.**

**At the server console prompt, type**

`LOAD INSTALL <Enter>`

- 2. From the “Installation Options” menu, choose “Volume Options” and press <Enter>.**

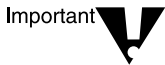
All existing volumes are listed.

- 3. Select the volume whose name you want to change and press <Enter>.**

The “Volume Information” screen is displayed.

- 4. Use the arrow keys to highlight the “Name” field, and press <Enter>.**

- 5. Backspace to erase the old name; then type in a new name and press <Enter>.**



Do not change the name of volume SYS: to another name. A volume called SYS: is mandatory.

- 6. Press <Esc> twice; then press <F10> to save the volume information.**

If you have not dismounted the volume it is automatically dismounted now.

- 7. When prompted, answer “Yes” to mount the volume with the new name.**

- 8. To set the Volume object name and context in Novell Directory Services, you are prompted to log in to the Directory.**

- 9. After you log in, verify that the displayed context and Volume object name are correct.**



Renaming a volume with INSTALL creates a Volume object with the new name. It does not delete the Volume object with the old name.

- 10. Use NWADMIN or NETADMIN to delete the old Volume object from the Directory tree.**



## Additional Information

For more information about	See
Dismounting volumes	"Mounting and Dismounting Volumes" on page 471
Using NWADMIN to delete the old Volume object	"Deleting Objects Using NetWare Administrator" on page 81
Using NETADMIN to delete the old Volume object	"Deleting Objects Using NETADMIN" on page 82

## Setting Up a Volume to Store Non-DOS Files

By default, NetWare volumes support DOS naming conventions. To store non-DOS files (such as for Macintosh, OS/2, Windows 95, or UNIX files) on a NetWare volume, you must load the appropriate name space NLM program and add the name space support to that volume.

The following name space NLM programs are included with NetWare:

- ◆ MAC.NAM (Macintosh)
- ◆ LONG.NAM (OS/2, Windows 95, Windows NT)
- ◆ NFS.NAM (NFS)

In addition, an FTAM name space module is available from third-party providers.



Each name space added to a volume requires additional server memory. If you add name space support to a volume and do not have enough memory, that volume cannot be mounted.

## Calculating Memory Required for Name Space Support

Use the following formula to calculate the additional memory required for each added name space on a non-DOS volume:

$$0.032 \times \text{volume\_size(in MB)} / \text{block\_size(in MB)}$$

Round the result to the next highest megabyte.

For example, adding Macintosh name space to a 100MB volume with a block size of 4 KB would require 1 MB of additional memory, as shown:

$$0.032 \times 100 \text{ MB} / 4 = 0.8 \text{ MB}$$

## Adding a Name Space



### Prerequisites

- A mounted volume
- Sufficient memory



### Procedure

1. **Load the appropriate name space NLM by typing**

```
LOAD [path]name_space <Enter>
```

For example, to load the name space module for Macintosh support, type

```
LOAD MAC.NAM <Enter>
```

#### **Add name space support to the volume by typing**

```
ADD NAME SPACE name to volume_name <Enter>
```

Replace *name* with the name space NLM. Replace *volume\_name* with the name of the volume that will store the non-DOS files.

For example, to add the Macintosh name space to the MACVOL volume, type

```
ADD NAME SPACE MAC TO MACVOL <Enter>
```



You only need to add a name space to a volume once. You don't need to add it each time the server comes up. The name space module autoloads each time the server comes up.

To verify that the name space has been added, view a list of all added name spaces by typing

```
ADD NAME SPACE <Enter>
```

## 2. To see a list of current volumes and name spaces, type

VOLUME <Enter>

### Additional Information

For more information about	See
ADD NAME SPACE command	"ADD NAME SPACE" in <i>Utilities Reference</i>
Name space	"Name space support" in <i>Concepts</i>

## Removing Name Space Support

Once a name space is added to a volume, the name space can be removed either by deleting the volume and re-creating it or by using VREPAIR.

To use the VREPAIR method, see the next section, "Repairing Volumes" on page 477. To delete a volume, see "Deleting Volumes" on page 472.

## Repairing Volumes

Typically, you can't mount a volume if it has even minor damage. Occasionally, however, a damaged volume mounts, but causes errors in the process.

Use VREPAIR to correct volume problems or to remove name space entries from File Allocation Tables (FATs) and Directory Entry Tables (DETs).

You can run VREPAIR on a bad volume while other volumes are mounted. Following are typical instances when VREPAIR can help:

- ◆ A hardware failure either prevented a volume from mounting or caused a disk read error.
- ◆ A power failure caused a corrupted volume.



Although VREPAIR can't fix hardware problems, VREPAIR can sometimes fix related volume damage.

- ◆ The server console displays a mirroring error when the server boots. This mirroring refers to the two copies of FATs and DETs that the operating system keeps (if disks are mirrored, NetWare keeps four copies).

If a volume fails to mount as the server is booting, VREPAIR loads automatically and attempts to repair the volume.

When VREPAIR autoloads, it uses the default options. If you want to use an alternate option, load VREPAIR manually and set the alternate option before running VREPAIR.



If you don't want VREPAIR to automatically repair a volume that won't mount, use the "Automatically Repair Bad Volumes" SET parameter to change the default. (See "SET" in Utilities Reference.)

### Prerequisites



- The volume you want to repair must be dismounted.
- If the volume to be repaired has name space support, the corresponding VREPAIR name space module (*V\_namespace.NLM*) must be located in either the SYS:SYSTEM directory or in a search path directory.

Example modules include V\_MAC.NLM and V\_LONG.NLM.

## Procedure

### 1. At the server console prompt, type

```
LOAD VREPAIR [volume name] [logfile name] <Enter>
```

(Optional) Replace *volume name* with the name of the volume to repair. If there is only one volume that is dismounted, you don't need to specify this parameter, since VREPAIR will attempt to repair that volume.

(Optional) If you want to save the error log, replace the *logfile name* with the name of the file you want VREPAIR to create. VREPAIR creates a log of errors it finds. VREPAIR displays the errors on screen and will write them to a file if you specify a filename.

When you load VREPAIR, an "Options" menu is displayed.

### 2. Accept the default options, or select alternate options, as appropriate.

The first time you try to repair a volume, accept the default options. If the default options fail to repair the volume, select alternate options.

#### 2a. To accept the default options, continue with Step 3.

#### 2b. To set alternate options at the "Options" menu, choose "Set VRepair Options" by typing

```
2 <Enter>
```

For more information on the options that are displayed, see "VREPAIR" in *Utilities Reference*.

### 3. To begin the repair process, choose "Repair A Volume" from the "Options" menu.

- ◆ If more than one volume is dismounted, select the volume to repair from those listed.
- ◆ If only one volume is dismounted, VREPAIR assumes it is the volume that needs repairing and begins the repair.

As the volume is being repaired, the server console screen displays a message indicating VREPAIR activity.

**4. (Optional) Modify error log settings after the repair has started.**

If VREPAIR finds many errors during the repair process, you might want to change some of the run-time error settings. To modify these settings after the repair has started, press <F1> to display the “Current Error Settings” menu.

- ◆ Select Option 1 if you do not want VREPAIR to pause after each error.
- ◆ Select Option 2 if you want VREPAIR to log errors in a text file.
- ◆ Select Option 3 to stop the repair of the volume.
- ◆ Select Option 4 to continue with a volume repair after you have stopped it.

**5. When the repair is complete, answer “Y” when prompted to write repairs to the disk.**

**6. If VREPAIR has found errors, run VREPAIR again by repeating Steps 2 through 6. Repeat until VREPAIR finds no errors.**

If you are unable to mount the volume after running VREPAIR a number of times, you must delete the volume, re-create the volume using INSTALL, and then restore the data from backups.

**Additional Information**

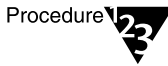
For more information about	See
Using VREPAIR	“VREPAIR” in <i>Utilities Reference</i>
Dismounting a volume	“Mounting and Dismounting Volumes” on page 471
Creating a volume	“Creating Volumes” on page 469
Setting the Automatically Repair Bad Volume parameter	“SET” in <i>Utilities Reference</i>
Setting and viewing the console search path	“SEARCH” in <i>Utilities Reference</i>

## Adding a Segment to an Existing Volume



### Prerequisites

- An existing NetWare partition with free space. (To create a NetWare partition, see “Creating NetWare Disk Partitions” on page 511.)



### Procedure

1. **At the server console prompt, type**  
  
`LOAD INSTALL <Enter>`
2. **From the “Installation Options” menu choose “Volume Options.”**
3. **Press <Insert> or <F3> to view existing volume segments.**
4. **Select a segment that has free space (no volume assignment) and press <Enter>.**



If no free space exists, you can't add a segment to a volume.

5. **To add this segment to an existing volume, select “Make This Segment Part of Another Volume” and press <Enter>.**  
  
A list of existing volumes appears.
6. **Select the volume you want to add this segment to, and press <Enter>.**
7. **Verify that the segment has been added in the “Volume Disk Segment List.” Then press <Esc>.**
8. **To save volume assignments to disk, press <F10>.**

## Modifying the Size of a Volume

A volume can have multiple segments spanning multiple hard disks. This arrangement allows you to add a hard disk when you need to expand a given volume.



Warning

You can add segments to a volume without destroying data, but removing any segment from a volume destroys *all* of the data on the volume.

Keep the following requirements in mind if you plan to expand volumes:

- ◆ The maximum number of segments allowed per volume is 32.
- ◆ The maximum number of segments you can create on one hard disk is 8.
- ◆ The maximum number of volumes allowed is 64.

### Procedure



Procedure

**At the server console prompt, type**

```
LOAD INSTALL <Enter>
```

- 9. From the “Installation Options” menu choose “Volume Options.”**

All existing volumes are listed.

- 10. Press <Insert>.**

The “Volume Disk Segments List” is displayed.

- 11. Select the volume segment to modify and press <Enter>.**

The status of that segment is displayed.



12. **From the status display, determine what kind of modification you can do:**
  - ◆ If the status of the volume segment is “N” (new), you can change the size of the segment. For instructions, see Step 13.
  - ◆ If the status of the volume segment is “E” (existing), you can’t change the size of the segment.

You can increase the volume size by adding new segments. (See “Adding a Segment to an Existing Volume” on page 481.)
  - ◆ If you want to reduce the size of the segment or volume, you must delete the entire volume with all segments, and then re-create the volume. See “Deleting Volumes” on page 472.
13. **Type the new volume size in megabytes (or a fraction thereof) on the “Disk Segment Parameters” screen.**
14. **Press <Esc> twice; then press <F10> to save the settings.**

## Using a CD-ROM as a NetWare Volume



CDROM allows the NetWare server to use a CD-ROM disc as a NetWare volume.

Treat the CD-ROM as a read-only volume. Do not enable block suballocation or use file compression on the volume. These actions will corrupt the CD-ROM volume index data.

If you enable block suballocation or file compression by mistake, load the CDROM module, then use the CD command to rebuild the volume’s index file. For command syntax, see “CD” in *Utilities Reference* or type CD HELP at the server console prompt.

NetWare 4.11 supports CD-ROMs that are mounted with the MAC and NFS name spaces.

The CDROM.NLM program supports High Sierra and ISO 9660 formats.

CDROM.NLM also supports HFS (Apple) file systems with an add-on module called HFSLFS.NLM, included with NetWare. To enable HFS support, load the HFSLFS module after loading CDROM.

## Mounting a CD-ROM as a NetWare Volume

To mount a CD-ROM disc as a NetWare volume, follow these steps.

Checklist



- Volume SYS: mounted
- An installed host bus adapter (HBA) that is NetWare compatible and supports CD-ROM devices
- The NetWare Peripheral Architecture™ (NPA) module, NWPA.NLM.
- The disk driver file and necessary support modules

Note



Some disk drivers consist of more than one file and some HBA devices require additional support modules for CD-ROM functionality. These files should accompany the HBA. For specific file requirements, consult your adapter documentation.

NetWare 4.11 includes the third-party HBA device drivers that are Novell-certified for NetWare 4.11. If the HBA is certified to support CD-ROM devices, the necessary support modules are also included with NetWare.

You can copy these files during installation, or you can copy them from the NetWare distribution media using NWXTRACT. (For help, see "NWXTRACT" in *Utilities Reference*.)

### Procedure

Procedure



1. **At the server console prompt, load the disk driver by typing**

```
LOAD [path]disk_driver <Enter>
```

Replace *disk\_driver* with the name of the disk driver specified in the HBA documentation.

You may be prompted to supply command line values such as a port or slot number for the HBA. Consult your HBA documentation for this information.

For example, to load the disk driver for the Adaptec AHA-1522 SCSI HBA, type

```
LOAD [path]AHA1520.DSK <Enter>
```

```
LOAD [path]ASPICD.DSK <Enter>
```

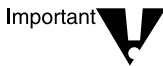
Some files may be automatically loaded. In this example, ASPITRAN.DSK is automatically loaded when AHA1520.DSK is loaded.

If your disk driver autoloads the ASPITRAN.DSK driver, you need to load either one of the following: ASPICD.DSK or CDNASPI.DSK. In this example, we used ASPICD.DSK.

## 2. Load the NWPA.NLM (NetWare Peripheral Architecture) driver by typing

```
LOAD NWPA.NLM <Enter>
```

This is the device-independent software that interfaces with the Media Manager.



CDROM.NLM will not load unless the NWPA.NLM interface has been loaded.

## 3. Load CDROM.NLM by typing

```
LOAD CDROM <Enter>
```



When a CD-ROM volume is being mounted or a CD-ROM disc is being changed, CD-ROM devices might be deactivated. Do not be alarmed. This deactivation occurs because device configuration information is being updated.

## 4. Mount the CD-ROM as a volume by typing

```
CD MOUNT [object number] | [volume name]  
[name space] [/option] <Enter>
```



The *object number* is the Media Manager object number (hereafter called the *object number*).

Replace *object number* with the object number or replace *volume name* with the volume name of the CD-ROM disc. (You can use the CD DEVICE LIST or CD VOLUME LIST command to see the object numbers and volume names.)

If appropriate, add name space support for the volume by replacing *name space* with /MAC or /NFS name space, or use both name spaces.

If appropriate, replace *option* with any of the following

- ◆ /R: Rebuilds the index file for a CD-ROM volume.
- ◆ /G= *group number*: Sets the default volume group access rights while mounting the volume.
- ◆ /X: Excludes a directory, at the root level, on the CD-ROM.
- ◆ /I: Mounts the volume even if importing errors are found and not all files are available.
- ◆ /dup: Checks for duplicate patterns on filenames in the same directory.
- ◆ /all: Mounts all of the CD-ROM volumes. Because “all” is used as an option name, do not give a CD-ROM volume the name “all.”
- ◆ /DNVC=*number*: Adds Direct Map caching to a CD-ROM volume when creating a new index during the mount process.

This allows information from the CD-ROM to be cached on the hard disk, providing faster recall. Of the three caching options, Direct Map caching provides the fastest performance, but information may not remain in the cache as long as with the other options.

The *number* is the number of megabytes that will be used as a nonvolatile cache. This space is created on the volume that holds the current indexes.

When using this option, be sure enough space is available on the selected index volume.

This option cannot be used with any other cache option.

- ◆ /ANVC=*number*: Adds Set Associative caching to a CD-ROM volume when creating a new index during the mount process.

This allows information from the CD-ROM to be cached on the hard disk, providing faster recall. Of the three caching options, Set Associative caching provides a medium level of performance.

The *number* is the number of megabytes that will be used as a nonvolatile cache. This space is created on the volume that holds the current indexes.

When using this option, be sure enough space is available on the selected index volume.

This option cannot be used with any other cache option.

- ◆ `/LNVC=number`: Adds Associative (LRU) caching to a CD-ROM volume when creating a new index during the mount process.

This allows information from the CD-ROM to be cached on the hard disk, providing faster recall. Of the three caching options, Associative (LRU) caching provides slower performance, but information will remain in the cache longer than with the other options.

The *number* is the number of megabytes that will be used as a nonvolatile cache. This space is created on the volume that holds the current indexes.

When using this option, be sure enough space is available on the selected index volume.

This option cannot be used with any other cache option.

For example, to mount the NetWare\_41 CD-ROM, type

```
CD MOUNT NETWARE_41 <Enter>
```



It may take several minutes to mount the volume, depending on the size of the CD-ROM and on the speed of your computer.

**5. (Optional) To mount the CD-ROM as a NetWare volume each time the server comes up, do the following:**

**5a. Edit your STARTUP.NCF file to add the disk driver.**

For example:

```
LOAD [path]disk_driver  
LOAD [path]ASPICD.DSK  
LOAD [path] NWPA.NLM
```

If your disk driver autoloads the ASPITRAN.DSK driver, load either one of the following: ASPICD.DSK or CDNASPI.DSK. In this STARTUP.NCF file example, we used ASPICD.DSK.

## 5b. Edit your AUTOEXEC.NCF by adding the following:

```
LOAD CDROM
CD MOUNT [object number] | [volume name]
        [name space] [option]
```

### Additional Information

For more information about	See
Using the CD command	"CD" in <i>Utilities Reference</i> , or type CD HELP at the console
Using CDROM.NLM	"CDROM" in <i>Utilities Reference</i>
Editing .NCF files	"Creating or Editing a Server Batch (.NCF) File" on page 416
Novell-certified device drivers for NetWare 4	Call 1-800-NETWARE (1-800-638-9273) or 1-801-222-6000

### Administering a CD-ROM as a NetWare Volume

Using the CD console commands associated with CDROM, you can do the following:

- ◆ Monitor the status of CD-ROM devices and NetWare volumes
- ◆ Change the media in a CD-ROM device
- ◆ Display the root directory on a NetWare CD-ROM volume
- ◆ Mount and dismount CD-ROM volumes
- ◆ Add and delete group names

For information on command syntax and for examples of these procedures, see "CD" in *Utilities Reference*.

You can also type

```
CD HELP <Enter>
```

at the server console prompt to get information.

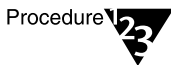
## Managing Server Hard Disks

This section describes how to determine available disk space, how to increase available disk space by compressing files and purging files, and how to add a hard disk to a NetWare server.

### Checking Available Disk Space with NDIR

You should monitor available disk space regularly and keep a log so you can track disk usage over time. This information helps you make the best use of your disk space management options, such as adding a new hard disk, compressing files, and migrating data to an offline system such as an optical disc library.

#### Procedure



1. **At the workstation, type**

```
NDIR volume: /VOL <Enter>
```

Statistics for the volume you selected appear on the screen.

For more information about the NDIR utility, see “NDIR” in *Utilities Reference*.

2. **Write down the percentage shown for Space remaining on volume.**
3. **Repeat this procedure weekly for each volume.**

Tracking this percentage over time helps you predict when a volume may run out of disk space.



You may want to enter the disk space information into a spreadsheet to create a graph of disk usage over time.

## Using File Compression

File compression allows you to store more information on a server hard disk.

File compression is enabled or disabled at the volume level. Once enabled, it can be turned on and off for individual files and directories by setting compression attributes with FLAG, FILER, or the NetWare Administrator graphical utility.

See “Setting Compression for a File or Directory” on page 492.

When you install NetWare 4.11, the default is to enable file compression. However, you can override the default and disable file compression during installation.

If you disable file compression, you can enable it later. Once enabled, however, file compression cannot be turned off unless you first re-create the volume.

## Managing File Compression on Files and Directories

It isn't necessary to separate applications from data for file compression, because the Days Untouched Before Compression SET parameter can eliminate the compression of applications that are used regularly.

This parameter specifies the number of days that must pass without access to a file before the file can be compressed. The parameter uses the last accessed date to gauge whether a file should be compressed or not.

To avoid the overhead of uncompressing files that don't compress well, the system calculates the compressed size of a file before actually compressing it.

If no disk space will be saved by compression, or if the size difference does not meet the value specified by the Minimum Percentage Compression Gain SET parameter, the file is not compressed.

For a file to be uncompressed, there must be enough free space on the volume to accommodate the uncompressed file size.



## Enabling File Compression on a Volume

When you install NetWare or create a new volume, file compression is enabled by default. You may override the default and disable file compression when the volume is created.

The following procedure explains how to enable file compression on a volume for which compression was disabled.



Once file compression is enabled for a volume, you can't disable it unless you first re-create the volume.



If you have a CD-ROM volume mounted as a NetWare volume, you should treat it as a read-only volume.

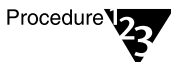
Do not use file compression on a CD-ROM volume. This will corrupt the CD-ROM volume index data. If you do so by mistake, use the CD command to rebuild the volume's index file. For command syntax, see "CD" in *Utilities Reference*.

### Prerequisites



- 1 MB of available RAM on the server during the time file compression is running.

### Procedure



**At the server console prompt, type**

```
LOAD INSTALL <Enter>
```

- 4. Select "Volume Options" from the "Installation Options" menu.**

A list of volumes appears.

- 5. Select the volume for which you want to enable file compression.**

The Volume Information screen appears, showing the current settings for the volume.

- 6. Use the Down-arrow key to move the cursor to the File Compression field and press <Enter>. Change the setting from Off to On.**

7. Press <Esc> twice to save the new value and redisplay the Installation Options menu.

## Setting Compression for a File or Directory

Once file compression is enabled for a volume, turn it on or off for individual files and directories by using FLAG, FILER, or NetWare Administrator.

You may want to group the files you want to compress into different directories from those you don't want to compress. For example, if you have data you don't access often, such as quarterly reports, you can create a directory called QUARTER and set it for immediate compression. Then when files are moved into the QUARTER directory, they stay compressed until the next report time, taking up much less disk space.

## Using FLAG to Set Compression Attributes

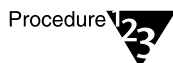
You can use the FLAG utility from a workstation to set attributes for a directory or file. The attributes are Immediate Compress (IC) and Don't Compress (DC).

### Prerequisites



- A workstation running DOS 3.30 or later, or OS/2 v2.x
- File compression enabled for the volume
- Modify File or Directory right to the file or directory you are setting

### Procedure



#### At the workstation, type

```
FLAG <Enter>
```

The attributes for the current drive appear.

If you are not in the directory where you want to set the file compression attributes, enter the drive letter or the complete path after the FLAG command.

**8. Enter the file compression option you want to apply to the file or directory.**

For example, if you want the files in the subdirectory LETTERS to be compressed each time a file is created or moved into the directory, type the Immediate Compress option:

```
FLAG SYS:DOC\LETTERS IC <Enter>
```

If you have an APPS directory for files that you do not want compressed at any time, type the Don't Compress option:

```
FLAG SYS:APPS DC <Enter>
```

For more information, see "FLAG" in *Utilities Reference*.

## Using FILER to Set Compression Attributes

You can set file compression attributes with the FILER menu utility. The attributes are Immediate Compress (IC) and Don't Compress (DC).

Online help appears at the bottom of each screen to help you use FILER, and you can press <F1> for more detailed help.

### Prerequisites



- A workstation running DOS 3.30 or later.
- A minimum of 512 KB of memory available on the workstation.
- File compression enabled for the volume.
- Modify File or Directory right to the file or directory you are setting.

### Procedure



#### At the workstation, type

```
FILER <Enter>
```

A list of available options appears.

9. **Select “Manage Files and Directories” from the “Available Options” menu and press <Enter>.**

A list of files appears in the “Directory Contents” window.

10. **Select the file you want to set file compression attributes for, and press <F10>.**

11. **Select “View/Set File Information” from the “File Options” menu and press <Enter>.**

12. **Select the “Attributes” list in the “File Information” display and press <Enter>.**

The “Current File Attributes” window appears.

13. **Press <Insert> to see other file attributes.**

14. **Select “Immediate Compress” or “Don’t Compress” from the “Other File Attributes” window and press <Esc>.**

The compression attribute you selected (Ic or Dc) appears in the attributes list.

15. **To exit FILER, press <Alt>+<F10>.**

## Using NetWare Administrator to Set Compression Attributes

You can set file compression attributes with the NetWare Administrator. The attributes are Immediate Compress (IC) and Don’t Compress (DC).

### Prerequisites



- A Windows 3.1x, Windows 95, or OS/2 workstation running NetWare Administrator
- 6 MB of available RAM on the Windows workstation, or 12 MB of available RAM on the OS/2 workstation
- File compression enabled for the volume
- Modify File or Directory right to the file or directory you are setting

## Procedure

1. **Start NetWare Administrator.**
2. **Select the file you want to set file compression attributes for.**  
To see a file in the NetWare Administrator, choose a volume object and then choose the directory the file resides in.
3. **From the “Object” menu, choose “Details.”**
4. **Choose the “Attributes” button.**
5. **From the “File Attributes” list, choose “Immediate Compress” or “Don’t Compress.”**
6. **Choose “OK.”**

## Additional Information

For more information about	See
Changing SET parameters	“SET” and “SERVMAN” in <i>Utilities Reference</i>
File compression	“File compression” in <i>Concepts</i>
Viewing file compression attributes for a directory or a file	“Viewing Other Information about a Directory or File” on page 157 “FLAG” and “NDIR” in <i>Utilities Reference</i>
Viewing file size	“Viewing Other Information about a Directory or File” on page 157 “FILER” and “NDIR” in <i>Utilities Reference</i>

## Suspending File Compression

You can suspend file compression temporarily by using the Enable File Compression SET parameter. Follow this procedure.

### Procedure



1. **At the server console prompt, load either SERVMAN or MONITOR.**

```
LOAD SERVMAN | MONITOR <Enter>
```



You can also set parameters with the SET command. See “SET” in *Utilities Reference*.

2. **Select “File System” from the “Categories” menu.**
3. **Select “Enable File Compression” and change the value to OFF.**

If this parameter is set to OFF, any files that would normally be compressed are queued and will be compressed as soon as the parameter is reset to ON.

If you have many files to compress, server performance may be affected when you turn file compression back on. If so, make sure you set file compression to be activated during nonpeak hours. See the Compression Daily Check Stop Hour and the Compression Daily Check Starting Hour parameters in Table 7-2 on page 498.

4. **Press <Esc> twice to display the “Update Options” menu.**
5. **Choose “Update AUTOEXEC.NCF and STARTUP.NCF Now” from the “Update Options” menu.**

You are prompted to update the STARTUP.NCF file.

6. **If the SET parameters are in the STARTUP.NCF file, press <Enter> to update the values in the file. Otherwise, press <Esc>.**

You are prompted to update the AUTOEXEC.NCF file.

7. If the SET parameters are in the AUTOEXEC.NCF file, press <Enter> to update the values. Otherwise, press <Esc>.

Changes to the parameters take effect immediately.

If you do not update either of the .NCF files, changes to the parameters last only until you reboot the server.

## Using SET to Control File Compression

You can control various aspects of file compression by using the file compression SET parameters. For example, the Compression Daily Check Starting Hour parameter determines when the file compressor begins scanning volumes for files that need to be compressed. File compression SET parameters do not affect volumes on which compression is disabled.

To change SET parameters, execute the SET command at the server console prompt, or use the SERVMAN or MONITOR utility.

For more information about executing the SET command, see “SET” in *Utilities Reference*.

For more information about using SERVMAN, see “SERVMAN” in *Utilities Reference*. The instructions for using SERVMAN also apply to MONITOR.



In most cases, the default values for the SET parameters are the most efficient. We recommend you read this section before changing the default values.

You might want to add the file compression SET parameters to your AUTOEXEC.NCF or STARTUP.NCF file so that they are executed whenever the server is brought up.

You can use EDIT or INSTALL to edit the AUTOEXEC.NCF or STARTUP.NCF file. You can use SERVMAN or MONITOR to change the value of parameters that have already been set in either file.

Table 7-2 lists the file compression SET parameters and their default values. The settings apply to all files and directories in compression-enabled volumes on the server.

**Table 7-2**  
**SET Parameters for File Compression**

SET Parameter and Default	Explanation
Compression Daily Check Stop Hour=6 (6:00 a.m.)	Sets the hour when the file compressor stops scanning volumes for files that need to be compressed. Hours are specified by a 24-hour clock. Supported values: 0 to 23.
Compression Daily Check Starting Hour=0 (midnight)	Sets the hour when the file compressor starts scanning volumes for files that need to be compressed. Hours are specified by a 24-hour clock. Supported values: 0 to 23.
Minimum Compression Percentage Gain=20 (%)	Specifies the minimum percentage a file must compress in order to remain compressed.
Enable File Compression=ON	Allows file compression to occur on compression-enabled volumes. If you set this parameter to OFF, compression is suspended temporarily. Files flagged for compression are queued until the parameter is reset to ON.
Maximum Concurrent Compressions=2	Specifies the number of volumes that can compress files at the same time. Increasing this setting may slow server performance.
Convert Compressed To Uncompressed Option=1	Determines how the server stores a file after the file has been accessed. <ul style="list-style-type: none"> <li>◆ Option 0 always leaves the file compressed.</li> <li>◆ Option 1 leaves the file compressed after the first access since a file compression. The second access leaves the file uncompressed.</li> <li>◆ Option 2 always leaves the file uncompressed.</li> </ul>
Decompress Percent Disk Space Free To Allow Commit=10(%)	Specifies the percentage of free disk space required on a volume before committing an uncompressed file to disk. This prevents newly uncompressed files from filling up the volume.
Decompress Free Space Warning Interval=31 minutes 18.5 seconds	Specifies the interval for displaying warning alerts when the volume has insufficient free disk space for uncompressed files. To turn off the alerts, set the parameter to 0.



Table 7-2 continued

## SET Parameters for File Compression

SET Parameter and Default	Explanation
Deleted Files Compression Option=1	Determines how the server handles unpurged deleted files. <ul style="list-style-type: none"><li>◆ Option 0 doesn't compress deleted files.</li><li>◆ Option 1 compresses deleted files during the next search.</li><li>◆ Option 2 compresses deleted files immediately.</li></ul>
Days Untouched Before Compression=14	Specifies the number of days that must pass with no access to the file before the file can be compressed.

## Purging Files from a Disk

Purging deleted files frees disk space on the NetWare server's hard disk. You can purge files manually, or you can set up automatic purging.



Warning

Purged files cannot be salvaged.

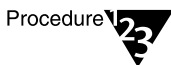
## Manually Purging Files

To purge deleted files manually, use the NetWare Administrator graphical utility, or the FILER or PURGE text utility. See "Purging Files" on page 166.

## Setting Up Automatic Purging with SET Parameters

You can set up automatic purging of all files on a NetWare server's hard disk, by setting the relevant parameters.

### Procedure



Procedure

1. **At the server console prompt, load either SERVMAN or MONITOR.**

```
LOAD SERVMAN | MONITOR <Enter>
```



Note

You can also set parameters with the SET command. See "SET" in *Utilities Reference*.

2. Choose “Server Parameters” from the “Available Options” menu.
3. Choose “File System” from the “Categories” menu.
4. Change the following parameters in the “File System” menu to the indicated values:



These settings cause the system to purge deleted files immediately. Therefore, the files cannot be salvaged. Be sure you have backups of important files.

```
Immediate Purge Of Deleted Files=ON
File Delete Wait Time=0
Minimum File Delete Wait Time=0
```

5. Press <Esc> twice to reach the “Update Options” menu.
6. Choose “Update AUTOEXEC.NCF and STARTUP.NCF Now” from the “Update Options” menu.

The system displays the path to the AUTOEXEC.NCF file.

7. If desired, press <Enter> to update the file.

The new parameter values take effect immediately. You do not need to reboot the server.

### Additional Information

For more information about	See
Purging files	“Salvageable files” in <i>Concepts</i>
Using the FILER utility	“FILER” in <i>Utilities Reference</i>
Using the PURGE utility	“PURGE” in <i>Utilities Reference</i>

## Adding Optical Storage for File Migration

The High Capacity Storage System (HCSS) extends the storage capacity of a NetWare server by integrating one or more optical library units, or jukeboxes, into the NetWare file system.

HCSS moves files between the server's hard disk and optical disks in a jukebox. HCSS uses hard disk free space to cache the files stored on optical disk. When the hard disk free space reaches a configurable threshold, HCSS migrates files to optical disk.

If you have installed an HCSS system on your network, you can set it to use as much or as little of the server's hard disk space as you want.

HCSS procedures are described in Chapter 6, "Migrating Data Using the High Capacity Storage System," on page 351

For more information about	See
HCSS functionality	"High Capacity Storage System" and "Data migration" in <i>Concepts</i>
HCSS installation and operating procedures	Chapter 6, "Migrating Data Using the High Capacity Storage System," on page 351

## Adding a Hard Disk to the NetWare Server

The procedures in this section explain how to add the following:

- ◆ An additional IDE hard disk ("Adding an Additional IDE Hard Disk" on page 502)
- ◆ An internal SCSI hard disk and adapter ("Adding an Internal SCSI Hard Disk and Adapter" on page 503)
- ◆ A SCSI hard disk to an existing subsystem ("Adding a SCSI Hard Disk to a Subsystem" on page 505)

Select the procedure that fits your situation.

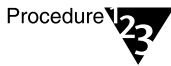
## Adding an Additional IDE Hard Disk

To add an additional internal IDE hard disk, complete the following steps.



### Prerequisites

- All users logged out of the server
- Access to the documentation that came with the hard disk
- Access to the documentation that came with the computer



### Procedure

**1. Bring down the server by typing**

```
DOWN <Enter>  
EXIT <Enter>
```

**2. Turn off power to the server.**

**3. Install and cable the hard disk.**

Make sure that the jumpers are configured so that one disk is the master and one the slave.

Refer to the documentation that came with the hard disk for more information.

**4. Configure the computer to recognize the new disk.**

For example, you may need to run the CMOS or EISA configuration utility. Refer to the documentation that came with the computer for information about configuration methods and requirements.

**5. Reboot the server.**

**6. At the server console prompt, type**

```
LOAD INSTALL <Enter>
```

**7. Use INSTALL to create a NetWare partition.**

If you need help, see “Creating NetWare Disk Partitions” on page 511.

**8. Create a new volume or designate the partition as a new segment of an existing volume.**

If you need help, see “Creating Volumes” on page 469 or “Adding a Segment to an Existing Volume” on page 481.

## Adding an Internal SCSI Hard Disk and Adapter

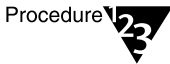
To install an internal SCSI hard disk and new adapter, complete the following steps.

### Prerequisites



- All users logged out of the server
- Access to the documentation that came with the hard disk and adapter board
- Access to the documentation that came with the computer

### Procedure



**1. Bring down the server by typing**

`DOWN` <Enter>

`EXIT` <Enter>

**2. Turn off power to the server.**

**3. Configure and install the new adapter.**

- ◆ Some adapters require you to set jumpers as part of the configuration process. Set jumpers on the adapter if necessary. Refer to the documentation that came with the board to learn what jumper settings may be required.
- ◆ Make sure both ends of the SCSI bus are terminated. Refer to the documentation that came with the adapter for more information.

4. **Install the hard disk, connect the power cable to the disk, and cable the disk to the new adapter.**
5. **If necessary, configure the computer to recognize the new disk and adapter.**

Refer to the documentation that came with the computer for more information about configuration methods and requirements.

6. **Reboot the server.**
7. **At the server console prompt, type**

```
LOAD INSTALL <Enter>
```

8. **Use INSTALL to load the disk driver.**

For more information about loading drivers, see “Loading Disk Drivers” on page 508.

9. **Use INSTALL to create a NetWare partition.**

If you need help, see “Creating NetWare Disk Partitions” on page 511.

10. **Do one of the following steps:**

- 10a. **Mirror the disk.**

For information about disk mirroring, see “Mirroring and Duplexing a Hard Disk” on page 514.

- 10b. **Create a new volume.**

If you need help, see “Creating Volumes” on page 469.

- 10c. **Designate the partition as a new segment of an existing volume.**

See “Adding a Segment to an Existing Volume” on page 481.

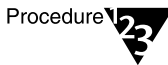
## Adding a SCSI Hard Disk to a Subsystem

A subsystem contains additional hard disks. To add a SCSI hard disk to an existing adapter in a subsystem, complete the following steps.



### Prerequisites

- All users logged out of the system
- Access to the documentation that came with the hard disk
- Access to the documentation that came with the computer



### Procedure

**1. Bring down the server by typing**

```
DOWN <Enter>  
EXIT <Enter>
```

**2. Turn off power to the subsystem.**

**3. Install the hard disk and cable it to the adapter.**

**4. Set the SCSI ID for the drive and terminate the SCSI bus.**

Refer to the documentation that came with the hard disk for more information about SCSI IDs and termination requirements.

**5. Turn on the power to the disk subsystem.**

**6. Reboot the server.**

**7. At the server console prompt, type**

```
LOAD INSTALL <Enter>
```

**8. Use INSTALL to create a NetWare partition.**

If you need help, see “Creating NetWare Disk Partitions” on page 511.

**9. Do one of the following steps:**

**9a. Mirror the disk.**

For information about disk mirroring, see “Mirroring and Duplexing a Hard Disk” on page 514.

**9b. Create a new volume.**

If you need help, see “Creating Volumes” on page 469.

**9c. Designate the partition as a new segment of an existing volume.**

See “Adding a Segment to an Existing Volume” on page 481.

## Replacing a Hard Disk

If a hard disk becomes unreliable or unusable, follow this procedure to remove the disk from the network.

Once you start this procedure, you must complete it; otherwise, the system hangs as it looks for the missing hard disk.

If you have been backing up your data consistently and verifying its integrity, you will be able to reload data for the volumes affected by the disk failure.

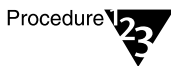


Although some hard disks (called “hot plug” devices) can be removed while the system is running, we do not recommend this practice.

If you do try to replace a mirrored hot-plug disk while the system is running, you must unmirror the disk first or run `SCAN FOR NEW DEVICES` as soon as the disk is removed. Failure to do one of these steps could cause the loss of all data on the disk’s mirrored partner when you install the replacement disk.

See “Unmirroring Hard Disks” on page 517 and “`SCAN FOR NEW DEVICES`” in *Utilities Reference*.

### Procedure



- 1. Make a backup copy of the data on the hard disk and verify its validity.**

Make sure the backup copy contains uncorrupted versions of all files and directories on the hard disk.



**2. If the disk is mirrored, dismount the volumes that reside on the disk by using either the DISMOUNT command or the INSTALL.nlm.**

- ◆ To use DISMOUNT, repeat the following command for each volume on the disk and then go to Step 3.

```
DISMOUNT [volume_name] <Enter>
```

- ◆ To dismount the volume using INSTALL, follow the procedure in “Mounting and Dismounting Volumes” on page 471. Repeat the process for all remaining volumes on the disk and then continue with Step 3.

**3. Unmirror the hard disk if it is mirrored.**

See “Unmirroring Hard Disks” on page 517.

**4. At the server console, bring down the server by typing**

```
DOWN <Enter>
```

```
EXIT <Enter>
```

**5. Turn off the system containing the hard disk to be replaced.**

**6. Remove the hard disk and install the replacement.**

Use the instructions that came with the hard disk and see “Loading Disk Drivers” on page 508.

**7. Turn on power and reboot the server.**

**8. If the replacement disk has been used before, delete any existing partitions on the replacement disk.**



Deleting disk partitions destroys *all* data on the deleted partitions. Be sure you delete the partitions on the new disk, not an existing disk.

**9. Create a partition on the replacement disk.**

See “Creating NetWare Disk Partitions” on page 511.

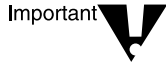
**10. Complete one of the following steps:**

**10a. If the disk was not mirrored, create the volumes that previously resided on the hard disk and restore the data from a backup.**

See “Creating Volumes” on page 469.

**10b. If the hard disk was mirrored, remirror the disk.**

See “Mirroring and Duplexing a Hard Disk” on page 514.



If you replaced the “Not Mirrored” disk rather than the “Out of Sync” disk, recover the volume data from the “Out of Sync” disk before remirroring the disks.

## Loading Disk Drivers

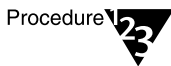
After you add or replace a hard disk on your NetWare server, you must load the corresponding disk driver.

Loading a disk driver enables communication between the disk controller and the server’s CPU.

Load the disk driver once for each disk adapter you want to support.

Most NetWare 4 disk drivers have a help file that appears on the screen as you highlight the driver. Refer to these descriptions to determine which driver to load.

### Procedure



- 1. At the server console prompt, load INSTALL by typing**  
`LOAD INSTALL <Enter>`
- 2. Select “Driver Options” from the “Installation Options” menu.**
- 3. Choose “Configure Disk and Storage Device Drivers” from the “Driver Options” menu.**

4. **If you want INSTALL to search the installed drivers and find those compatible with your disk adapter and disk, choose “Discover and Load Additional Drivers”; otherwise, continue with Step 5.**

If INSTALL finds only one driver compatible with your disk adapter, it loads the driver automatically.

If INSTALL finds more than one driver compatible with your disk adapter, it displays a message listing the hardware it detected.

- 4a. **Press <F3> to see a list of drivers compatible with the detected hardware. Select a driver from the list.**

- 4b. **After the driver is loaded, choose “Return to Previous Menu.”**

If you loaded a .HAM module, NetWare searches for the .CDM module compatible with the .HAM module.

If NetWare finds the .CDM module, it loads the module automatically. If NetWare does not find the .CDM module, it displays a list of available .CDM modules.

- 4c. **If the screen displays a list of .CDM modules, select the one you want.**

If you want to load additional drivers, continue with Step 5; otherwise, press <Alt>+<F10> to exit INSTALL.



In machines with PCI buses and sometimes in machines with EISA hardware, INSTALL may not detect all the drivers associated with the disk adapters. When this happens, INSTALL displays a message that lists the hardware for which disk drivers were not detected. The message prompts you to press <F3> to see a list of all available drivers.

Select the appropriate driver from the list and continue with Step 7 to modify driver parameters.

5. **Choose “Load an Additional Driver” from the “Additional Drivers Actions” menu.**
6. **Select the disk driver you want to load and press <Enter>.**

For example, if you are using an AT controller, the disk driver filename is ISADISK.DSK and its description filename is ISADISK.DDI.



Some drivers do not have a description file (a configuration file that's appended to the driver). These drivers have to be loaded manually, at the

system console. To load these drivers, follow the screen prompts or press <F1> for help.

**7. Choose “Select/Modify Driver Parameters.”**

The cursor becomes active in the parameter window for the selected driver. Default parameters may be displayed in the fields.

**8. Use the arrow keys to move from field to field. Press <Enter> to change a value in a field.**

When you move the cursor to a field, the system displays a help window that describes the field.

When you press <Enter> to change a value, the system usually displays a pop-up list of values from which you select the desired one.

**9. When finished setting parameter values, press <F10>.**

**10. Select “Save Parameters and Load Driver.”**

The system displays a message asking if you want to load another driver.

**11. If you want to load an additional driver, select “Yes” and repeat Steps 5 through 10.**

You can load the same driver more than once if you have additional disk controller boards of the same type. (Remember to check controller board settings for conflicts.)

**12. To exit INSTALL, press <Alt>+<F10>.**

## Additional Information

For more information about	See
.CDM and .HAM modules	"NetWare Peripheral Architecture" in <i>Concepts</i>
SCSI or IDE buses	"SCSI bus" and "IDE" in <i>Concepts</i>
Novell-certified device drivers for NetWare 4	Call 1-800-NETWARE (1-800-638-9273) or 1-801-222-6000.

## Creating NetWare Disk Partitions

NetWare partitions can be created on any hard drive and can coexist with other partitions such as DOS, OS/2, and UNIX.

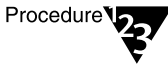
If you have partitions from previous versions of NetWare that you are no longer using, you can delete them and create a new NetWare partition. (See "Deleting NetWare Disk Partitions" on page 513 for more information.)



Note

Some machine vendors such as COMPAQ\* create a small partition that setup and configuration utilities can be run from. Don't delete this partition.

### Procedure



Procedure

1. **At the server console prompt, type**

```
LOAD INSTALL <Enter>
```

2. **Select "Disk Options" from the "Installation Options" menu.**
3. **Select "Modify Disk Partitions and Hot Fix" from the "Available Disk Options" menu.**

If you have more than one disk, the "Available Disk Drives" list appears. If this list appears, select the disk you want to partition.

A list of existing partitions appears, along with the "Disk Partition Options" menu.

4. **Select "Create NetWare Disk Partition" from the "Disk Partition Options" menu.**

NetWare allows only one NetWare partition per disk (unless the machine vendor presents multiple hard drives as one logical drive). If the disk has more than one free partition area, select an area for the NetWare partition.

A screen containing disk partition and Hot Fix information with their default values appears. The cursor is on the "Partition Size" field.

- 5. If you don't want to use the whole partition for NetWare, type a smaller value in the "Partition Size" field.**

The difference between the original size and the smaller size is added to the free space on the disk.

- 6. To change the size of the data area, use the arrow keys to move the cursor to one of the "Data Area" fields, and then type in a new value.**

One field contains the size of the data area in blocks, the other in megabytes. When you change the value in one field, the system changes the corresponding value in the other field.

- 7. To change the size of the Hot Fix Redirection Area, use the arrow keys to move the cursor to one of the "Hot Fix Redirection Area" fields, and then type in a new value.**

One field contains the size of the area in blocks, the other as a percentage of the partition. When you change the value in one field, the system changes the corresponding value in the other field.

- 8. Press <Esc> to display the "Create NetWare Partition?" window.**
- 9. Select "Yes."**
- 10. Press <Esc> twice to redisplay the "Available Disk Options" menu.**
- 11. To create NetWare partitions on additional disks, repeat Steps 3 through 10 for each disk. When finished, go to Step 12.**

12. If you want to mirror a disk, see “Mirroring and Duplexing a Hard Disk” on page 514. Otherwise, press <Esc> to exit.

## Deleting NetWare Disk Partitions



Note

The partition table displays partitions such as OS/2, UNIX, and XENIX\* as “Unknown Partition Type #.” Don’t delete these unknown partition types unless you know what is on them.

Some machine vendors such as COMPAQ create a small partition that setup and configuration utilities can be run from. Don’t delete this partition.

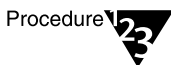
### Prerequisites



Checklist

- A backup copy of data on the partition, if needed
- All volumes on the partition dismounted and deleted

### Procedure



Procedure

1. **At the server console prompt, type**  
`LOAD INSTALL <Enter>`
2. **Select “Disk Options” from the “Installation Options” menu.**
3. **Select “Modify Disk Partitions and Hot Fix” from the “Available Disk Options” menu.**

If you have more than one disk, the “Available Disk Drives” list appears. If this list appears, select the disk you want from the “Available Disk Drivers” list.

A list of disk partitions on the selected disk appears at the top of the screen. The “Disk Partition Options” menu appears at the bottom of the screen.

**4. Select “Delete Any Disk Partition” from the menu.**

A list of the available disk partitions is displayed in a pop-up menu.

**5. Select the disk partition you want to delete.**

If you did not delete existing volumes from the disk partition, a message similar to the following appears:

```
WARNING: The selected disk partition may contain
valuable data; all data on the partition will be
lost.
```

```
<Press ENTER to continue>
```

**6. If you are ready to delete the partition, press <Enter>; otherwise, press <Esc>.**

If you press <Enter>, a confirmation box is displayed containing the message “Delete Disk Partition?”

**7. Select “Yes.”**

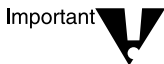
The space occupied by the deleted disk partition now appears as Free Space in the list of disk partitions at the top of the screen. You can create a new disk partition in this free space.

## Mirroring and Duplexing a Hard Disk

NetWare 4 enables you to protect data from hard disk failure by duplicating, or “mirroring,” one hard disk’s data on one or more other hard disks.

When you mirror hard disks over different disk channels or host bus adapters, this is called *duplexing*.

The INSTALL processes for mirroring and duplexing are the same. The term “mirroring” is used in all menus to refer to both mirroring and duplexing.



If you want mirroring with IDE/ATA disks, you must duplex them by mirroring them on separate host adapters or on different ports of a multiport IDE/ATA host adapter, with each port or adapter configured to support a single drive. This requirement is necessary because of a design limitation of the IDE drives that prevents them from continuing normally after one of the drives fails.



Following are some considerations to keep in mind when using mirrored disks:

- ◆ Mirroring requires the NetWare partitions to be exactly the same size. If they are not the same size, NetWare adjusts them to the same size during the mirroring process.
- ◆ Although you can mirror eight partitions together, mirroring two partitions is usually sufficient fault tolerance for most systems.
- ◆ If a hard disk fails and cannot be accessed by the server, you can unmirror the hard disks and salvage the volume from the functional disk. See “Recovering Data from an Unmirrored (Out of Sync) Hard Disk” on page 537.
- ◆ If you want to remove a hot-plug mirrored disk without bringing down the server, you must unmirror the disk first. See “Unmirroring Hard Disks” on page 517.



When mirroring two disks, one of the disks should be blank. Delete all partitions from the blank disk and then create a new NetWare partition on it. Do not create any volumes. When you mirror the disks, the disk containing data will be mirrored to the blank disk.

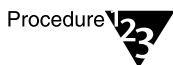
To mirror two disks to each other, follow these steps.

### Prerequisites



- One blank disk containing one new NetWare partition with no volumes
- A disk containing data you want to mirror

### Procedure



1. **At the server console prompt, type**  
`LOAD INSTALL <Enter>`
2. **Choose “Disk Options” from the “Installation Options” menu.**

**3. Choose “Mirror/Unmirror Disk Partitions” from the “Available Disk Options” menu.**

A “Disk Partition Mirroring Status” window appears. This window lists each device and its mirrored status. For example:

```
Mirrored: Device 1
Not Mirrored: Device 3
Out of Sync: Device 4
```

The meaning of each status is as follows:

Status	Explanation
Mirrored	The partition is mirrored to another partition.
Not Mirrored	The partition is not mirrored to another partition.
Out of Sync	The partition was mirrored to another partition, but is currently unmirrored.

**4. From the “Disk Partition Mirroring Status” list, choose one of the two devices (disk partitions) you want to mirror to each other.**

See “Device numbering” in *Concepts* for an explanation of how logical partitions relate to the installed hard disks.

A “Mirrored Disk Partitions” list appears. This window displays any hard disks that are currently mirrored to the partition you selected.

You must now specify another partition to be mirrored to the selected partition.

**5. Press <Insert>.**

The system displays the “Available Disk Partitions” list—a list of all partitions that can be mirrored to the first partition.

**6. Select the other partition from the “Available Disk Partitions” list.**

The system mirrors the two partitions to each other so that the blank partition contains the data from the other partition.



Note

If you are mirroring hard disks, the status on the “Mirrored Disk Partitions” list is now “Out of Sync” for one of the disks. As soon as mirroring is complete, the status of both disks changes to “In Sync.”

## Unmirroring Hard Disks

You must unmirror mirrored hard disks before you can delete a partition or conduct surface tests on a disk.



Warning

If you plan to replace a hot-plug mirrored disk while the system is running, you must first unmirror the disk. Failure to unmirror the disk could cause the loss of all data on its mirrored partner when you install a replacement disk.

### Procedure



Procedure

1. **At the server console prompt, type**  
  
`LOAD INSTALL <Enter>`
2. **Choose “Disk Options” from the “Installation Options” menu.**
3. **Choose “Mirror/Unmirror Disk Partitions” from the “Available Disk Options” menu.**

The system displays the “Disk Partition Mirroring Status” list.

4. **Select a mirrored partition from the list.**  
  
After you select a partition, the system displays the list of disk partitions in the mirrored set.
5. **Select the hard disk partition you want to unmirror from the first disk and press <Delete>.**

The system displays a message warning that the partition contains volume information.

6. **Press <Enter> to clear the message.**

**7. Choose “Yes” to salvage the information on the partition or “No” if you do not want to salvage the data.**

- ◆ If you choose “Yes,” the system warns that the selected partition contains a volume with a name and segment number matching an existing volume. Continue with Steps 7a and 7b.
- ◆ If you choose “No,” the data is destroyed and the “Mirrored Disk Partitions” list is redisplayed.

**7a. Press <Enter> to clear the message.**

The system prompts you to enter a new name for the volume.

**7b. Enter the new volume name.**

The “Mirrored Disk Partitions” list is redisplayed.

**8. Press <Esc> from the “Mirrored Disk Partitions” list.**

The “Partition Mirroring Status” list is displayed. The “Out of Sync” status appears next to the disk you unmirrored.

You can now

- ◆ Finish salvaging the information on the volume (if you chose to salvage information in Step 7) by pressing <F3> and following the prompts.
- ◆ Repair or replace the hard disk.
- ◆ Format the hard disk.
- ◆ Delete the partition on the hard disk.
- ◆ Allocate the unmirrored partition as a new volume segment.

You must first remove any existing volume information from the partition, if necessary. See “Recovering Data from an Unmirrored (Out of Sync) Hard Disk” on page 537 for information about removing existing volume information.

Then see “Creating Volumes” on page 469 for instructions on creating the new volume segment.

# Disaster Prevention and Recovery

The NetWare 4™ operating system includes security and fault tolerance features to protect network data from intruders, power problems, and system failures. This section describes ways to prevent network data loss, reduce system vulnerability, and recover from failures.

## Securing the Server Console

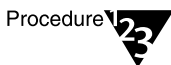
The server console is most secure when locked in a place where no one can reboot it. You can gain an additional level of security by using the SECURE CONSOLE utility.

SECURE CONSOLE provides the following security features, while still allowing authorized operators to use the console:

- ◆ Prevents NetWare Loadable Module programs from being loaded from any directory other than SYS:SYSTEM. This means no one can load an invasive NLM from a server's diskette drive or boot partition.
- ◆ Prevents keyboard entry into the operating system debugger. This restricts the ability to access secure data directly.
- ◆ Prevents anyone from changing the date and time. Some security and accounting features depend on date and time for their enforcement.

SECURE CONSOLE does not lock the server console; use the "Lock File Server Console" menu option in MONITOR to prevent keyboard entry at the console.

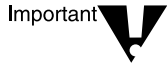
### Procedure



1. **At the server console prompt, type**

```
SECURE CONSOLE <Enter>
```

2. **(Optional) To secure the console whenever the server is booted, add the SECURE CONSOLE command to the server's AUTOEXEC.NCF file.**



To remove SECURE CONSOLE, you must down the NetWare server and reboot it. If the SECURE CONSOLE command is in the AUTOEXEC.NCF file, you must first remove it.

## Preventing Virus Infection

Keep viruses off the network by educating users about virus dangers and by enforcing procedures that reduce virus risks, such as the following:

- ◆ Back up data frequently.
- ◆ Maintain layers of archived backups so you can retrieve a backup from a preinfected file.
- ◆ Keep a write-protected, bootable diskette with the latest virus scan and removal software for all servers and workstations.
- ◆ Keep a backup of executable files and flag them Execute Only.
- ◆ Educate yourself about the infection techniques of the latest viruses.
- ◆ Educate network users about how to detect viruses.
- ◆ Warn users of the dangers of viruses. Discourage them from using diskettes and files that have been in computers away from work.
- ◆ Teach users to power down their workstations immediately upon encountering a virus.
- ◆ Restrict access to a server's diskette drives by locking the server in a secure room. Put tape over the drive openings to remind you not to use them unnecessarily.
- ◆ Avoid using the Supervisor account when possible. The fewer privileges your login account has, the less power a virus has to destroy data and to spread.

## Preventing Packet Forgery

NetWare 4 includes a security feature called NCP Packet Signature that protects servers and clients using the NetWare Core Protocol™ (NCP) services.

NCP™ Packet Signature prevents packet forgery by requiring the server and the client to “sign” each NCP packet. The packet signature changes with every packet.

NCP packets with incorrect signatures are discarded without breaking the client’s connection with the server. However, an alert message about the invalid packet is sent to the error log, the affected client, and the server console. The alert message contains the login name and the station address of the affected client.

### NCP Packet Signature Options

Because the packet signature process consumes CPU resources and slows performance both for the client and the NetWare server, NCP Packet Signature is optional.

Several signature options are available, ranging from never signing NCP packets to always signing NCP packets. NetWare servers and NetWare clients each have four settable signature levels.

The signature options for servers and clients combine to determine the level of NCP packet signature on the network.

You can choose the packet signature level that best meets both your system performance needs and network security requirements.



Some combinations of server and client packet signature levels may slow performance. However, low-CPU-demand systems may not show any performance degradation.

## When to Use NCP Packet Signature

NCP Packet Signature is not necessary for every installation. You may choose not to use NCP packet signature if you can tolerate security risks in situations such as

- ◆ When only executable programs reside on the server
- ◆ You know and trust all network users
- ◆ Data on the NetWare server is not sensitive and loss or corruption of this data would not affect operations

NCP Packet Signature is recommended for security risks such as

- ◆ An untrustworthy user at a workstation on the network
- ◆ Easy physical access to the network cabling system
- ◆ An unattended, publicly accessible workstation

## Server Signature Levels

Before changing the NCP Packet Signature level, read this entire section to understand all of the options.

To determine the server's current signature level, type

```
SET NCP Packet Signature Option <Enter>
```

To set a server's packet signature level, type

```
SET NCP Packet Signature Option = number
```

Replace *number* with 0, 1, 2, or 3. The default is 1.



Number	Explanation
0	Server does not sign packets (regardless of the client level).
1	Server signs packets <i>only</i> if the client requests it (client level is 2 or higher).
2	Server signs packets if the client is capable of signing (client level is 1 or higher).
3	Server signs packets and requires all clients to sign packets or logging in will fail.

You can use the SET console command to change the signature level from a lower to a higher level. You cannot change from a higher to a lower level unless you first reboot the server.

For example, if the current signature level is 2, you can't set the signature level to 1 by using the SET command at the console.

To change the signature level from 2 to 1, you must first reboot the server and then set the level to 1 by typing:

```
SET NCP Packet Signature Option = 1
```

You can add this SET command to your AUTOEXEC.NCF file to set the signature level each time the server is brought up.

## Client Signature Levels

To set DOS or MS Windows client signature levels, add the parameter to the workstation NET.CFG file. The format is as follows:

```
signature level = number
```

To set OS/2 client signature levels, add the parameter to the NET.CFG file under the NetWare Requester option. The format is as follows:

```
signature level number
```

Replace *number* with 0, 1, 2, or 3. The default is 1.

Number	Explanation
0	Client does not sign packets.
1	Client signs packets <i>only</i> if the server requests it (server level is 2 or higher).
2	Client signs packets if the server is capable of signing (server level is 1 or higher).
3	Client signs packets and requires the server to sign packets or logging in will fail.

### Effective Packet Signature

The NCP Packet Signature levels for the server and the client interact to create the effective packet signature for the network. Some combinations of server and client levels do not allow logging in.

“Effective Packet Signature of Server and Client” on page 524 shows the interactive relationship between the server packet signature levels and the client signature levels.

Figure 7-1  
Effective Packet  
Signature of Server  
and Client

If	Server = 0	Server = 1	Server = 2	Server = 3
Client = 0	○	○	○	⊘
Client = 1	○	○	●	●
Client = 2	○	●	●	●
Client = 3	⊘	●	●	●

- Packet signature
- No packet signature
- ⊘ No logging in

## Examples of Signature Levels in Different Situations

The default NCP Packet Signature level is 1 for clients and 1 for servers. In general, this setting provides the most flexibility while still offering protection from forged packets. Following are some examples of situations requiring different signature levels.

### All Information on the Server Is Sensitive

If an intruder gains access to *any* information on the NetWare server, it could damage the company.

Recommendation: Set the server to level 3 and all clients to level 3 for maximum protection.

### Sensitive and Nonsensitive Information Reside on the Same Server

The NetWare server has a directory for executable programs and a separate directory for corporate finances (such as Accounts Receivable).

Recommendation: Set the server to level 2 and the clients that need access to Accounts Receivable to level 3. All other clients remain at the default, level 1.

### Users Often Change Locations and Workstations

You are uncertain which employees will be using which workstations, and the NetWare server contains some sensitive data.

Recommendation: Set the server to level 3. Clients remain at the default, level 1.

### A Workstation Is Publicly Accessible

An unattended workstation is set up for public access to nonsensitive information, but another server on the network contains sensitive information.

Recommendation: Set the sensitive server to level 3 and the unattended client to level 0.

## Changing the Signature Level for an NLM using CLIB

NLM programs that use CLIB are assigned a default NCP Packet Signature level that corresponds to the current signature level of the server.

To change the packet signature level for *all* NLM programs using CLIB, use the following command format when you load CLIB:

```
LOAD CLIB /Lnumber
```

Replace *number* with 0, 1, 2, or 3.



Note

To make sure CLIB uses the correct signature level when it is automatically loaded by other NLM programs, put the command in the AUTOEXEC.NCF file.

To change the packet signature level for a single NLM, use the following command format when you load the NLM:

```
LOAD NLM [CLIB_OPT] /Lnumber
```

Replace *number* with 0, 1, 2, or 3.

For information about Packet Signature Levels, see “Server Signature Levels” on page 522.

## Packet Signature Considerations for Job Servers

A job server is a server that performs a task and then returns the completed task. Most job servers are third-party products.

You should be aware that some job servers do not support NCP Packet Signature. A job server may produce unsigned sessions if

- ◆ It does not operate on top of DOS
- ◆ It does not use standard NetWare shells
- ◆ It is not an NLM
- ◆ It uses its own implementation of the NCP engine (such as embedded print servers in printers)

## Minimizing Risks

To minimize security risks associated with job servers:

- ◆ Install queues only on servers with signature level 3.
- ◆ Do not allow privileged users to put jobs in queues on servers with signature levels below 3.
- ◆ Make sure the job server's account is unprivileged.
- ◆ Disable the job server's ability to change to client rights.

## Disabling Change to Client Rights

To prevent a job server from assuming the rights of a client, add the following SET command to the server's STARTUP.NCF file:

```
SET Allow Change to Client Rights = OFF
```

The default is ON, because certain job servers and third-party applications cannot function without changing to client rights. Refer to the documentation that comes with the job server to determine whether the job server can function without client rights.

## Additional Information

For more information about	See
NCP Packet Signature	"NCP Packet Signature" in <i>Concepts</i>
SET parameters	"SET" and "SERVMAN" in <i>Utilities Reference</i>

## Activating UPS Monitoring

An uninterruptible power supply (UPS) is an indispensable part of your network. Not only does it help prevent damage to your computers from power surges and brownouts, but it also prevents data loss during power outages.

### Using the UPS Module

If your UPS is connected to a serial port, you must use the UPS\_AIO module, instead of the UPS module. See the next section, “Using the UPS\_AIO Module” on page 529.

If your UPS is connected to any port except a serial port, use the following procedure to load UPS.NLM. You can specify the time the server functions on battery power and how long the battery needs to charge.

#### Prerequisites



Checklist

- The DCB.DSK device driver must be loaded if you are using a DCB to connect the UPS machine to the server.
- The UPS hardware must be installed according to the vendor's instruction manual.

#### Procedure



Procedure

- 1. At the server console prompt, load the UPS NLM by typing**

```
LOAD UPS <Enter>
```

A menu of available device types is displayed.

- 2. Choose the appropriate device type from the menu.**

Valid type names include DCB, mouse (IBM PS/2\*-style), standalone, and keycard.

- 3. When prompted, enter a valid I/O port number.**



Note

Valid I/O port numbers vary depending on your hardware. A list of valid port numbers is displayed. Refer to “UPS” in *Utilities Reference* for valid port numbers.

4. **When prompted, enter a discharge time, a recharge time, and a wait time.**

See “UPS” in *Utilities Reference* for valid values for these fields.

5. **(Optional) To automatically load UPS.NLM when the server boots up, add the LOAD UPS command to your AUTOEXEC.NCF file.**

You can edit the AUTOEXEC.NCF file by using INSTALL or EDIT.



You can set all required parameters when you load UPS.NLM. For example, you could add the following statement to your AUTOEXEC.NCF file:

```
LOAD UPS TYPE=DCB PORT=346 DISCHARGE=20 RECHARGE=120  
WAIT=10
```

6. **(Optional) To view the status of your UPS after loading UPS.NLM, type**

```
UPS STATUS <Enter>
```

7. **(Optional) To change the discharge or recharge settings for UPS.NLM, use the UPS TIME command at the server console.**

For example, you might use a command similar to the following:

```
UPS TIME DISCHARGE=10 RECHARGE=90 <Enter>
```

Remember to change the setting in the AUTOEXEC.NCF file if you want the server to retain the new setting after restarting the server.

### Additional Information

For more information about	See
Using UPS STATUS	“UPS STATUS” in <i>Utilities Reference</i>
Using UPS TIME	“UPS TIME” in <i>Utilities Reference</i>

### Using the UPS\_AIO Module

Use UPS\_AIO.NLM when you use a serial port to monitor an uninterruptible power supply. If you use some other port to monitor the

UPS, you should use UPS.NLM, as explained in the previous section, “Using the UPS Module.”

The UPS\_AIO module does not provide the same options as UPS.NLM. For example, UPS\_AIO.NLM does not allow you to change parameter settings after loading the module. To change the settings, you must reload the module with the new parameter values.

Several parameters can be entered when you load the UPS\_AIO module. To display a help screen that explains the parameters, enter the following command:

```
LOAD UPS_AIO ? <Enter>
```

The LOAD command with the ? parameter displays a help screen, but does *not* load the UPS\_AIO module.

### Choosing the Parameters You Need

You do not need to enter any parameters if the default values are acceptable. Before loading UPS\_AIO.NLM, review the following list to determine the parameters you might want to enter.

Parameter	Use to
<i>path</i>	Specify the path to UPS_AIO, if you moved it from the default directory
DOWNTIME= <i>number</i>	Specify the amount of time to run on battery before system shutdown. If power is restored before this time elapses, no shutdown will occur. If a low battery condition occurs before this time elapses, an immediate shutdown will occur.  <b>Supported values:</b> 30 seconds minimum, no practical maximum limit <b>Default:</b> 300 seconds



Parameter	Use to
MSGDELAY= <i>number</i>	<p>Specify the elapsed time before a broadcast message is first sent to users.</p> <p><b>Supported values:</b> 0 seconds minimum, no practical maximum limit  <b>Default:</b> 5 seconds</p> <p>The broadcast message states the time remaining until shutdown. This message is created automatically by the UPS.</p>
MSGINTERVAL= <i>number</i>	<p>Specify the time interval between broadcast messages sent to users. The message is repeated at this interval.</p> <p><b>Supported values:</b> 20 seconds minimum, no practical maximum limit  <b>Default:</b> 30 seconds</p> <p>The broadcast message states the time remaining until shutdown. This message is created automatically by the UPS.</p>
DRIVERTYPE= <i>number</i>	<p>Specify the AIO device driver type.</p> <p><b>Supported values:</b> 1, 2, 3  <b>Default:</b> 1</p> <p>The default value of 1 represents the AIOCOMX driver, which is included with NetWare. Other drivers may be represented by other driver type numbers. Refer to the documentation that came with the driver.</p>

Parameter	Use to
BOARD= <i>number</i>	<p data-bbox="799 231 1128 253">Specify the AIO board number.</p> <p data-bbox="799 282 1173 365"><b>Supported values:</b> Determined by the driver manufacturer <b>Default:</b> 0</p> <p data-bbox="799 395 1190 534">To determine the board number, read the driver information when the AIOCOMX driver is loaded. The information includes both the board and port numbers.</p> <p data-bbox="799 563 1138 672">If you do not use the AIOCOMX driver, refer to the driver documentation to determine the board number.</p>
PORT= <i>number</i>	<p data-bbox="799 707 1061 729">Specify the port number.</p> <p data-bbox="799 759 1173 842"><b>Supported values:</b> Determined by the driver manufacturer <b>Default:</b> 0</p> <p data-bbox="799 872 1190 1010">To determine the port number, read the driver information when the AIOCOMX driver is loaded. The information includes both the port and board numbers.</p> <p data-bbox="799 1040 1190 1149">If you do not use the AIOCOMX driver, refer to the driver documentation to determine the port number.</p>

Parameter	Use to
SIGNAL_HIGH	<p>Set the normal RS-232 signaling state to high.</p> <p><b>Supported values:</b> SIGNAL_HIGH or no value <b>Default:</b> none</p> <p>Use this parameter only if your UPS system uses high values, instead of low values, to determine if power is off or the battery is low. Most UPS systems use low values. Refer to your UPS hardware documentation to determine whether you need to use the parameter.</p>
?	<p>Display a help screen that explains the other parameters. When you use this parameter, the UPS_AIO module is not loaded. To load the module, execute LOAD UPS_AIO without the “?” parameter.</p>

### Prerequisites



- A serial port must be available.
- The UPS\_AIO module requires an AIO device driver, such as AIOCOMX, which is included with NetWare.
- You should know which parameters, if any, you want to specify when you load the UPS\_AIO module. See the previous section, “Choosing the Parameters You Need” on page 530.



## Procedure

### 1. To Load the AIOCOMX driver, type

```
LOAD [path]\AIOCOMX <Enter>
```

You can use another AIO driver, if specified by your hardware manufacturer.

When you load AIOCOMX, the screen displays the board and port numbers. If either the board or port number is not 0, note the number. You will enter the number as a parameter in the next step.

### 2. To Load the UPS\_AIO module, type

```
LOAD [path]\UPS_AIO [parameter...] <Enter>
```

If you do not enter a parameter, the default value for that parameter takes effect. For a description of parameters and their values, see the previous section, “Choosing the Parameters You Need” on page 530.

The screen displays the current status and activity of the module. These messages are also logged to the system error log, SYS\$LOG.ERR in the SYS:SYSTEM directory.

### 3. (Optional) To toggle from the status screen to other screens, press <Alt>+<Esc>.

To load the driver and the UPS\_AIO module automatically whenever you start the server, enter the LOAD commands into your AUTOEXEC.NCF file. You can use INSTALL or EDIT to add the commands to the file.

## Protecting Database Integrity with TTS

The Transaction Tracking System (TTS) can prevent data corruption by backing out of incomplete transactions and keeping a record of backed-out data.

By default, TTS™ is enabled.

The NetWare server automatically disables TTS if one of the following happens:

- ◆ The SYS: volume becomes full. (The SYS: volume is the TTS backout volume.)
- ◆ The NetWare server has insufficient memory to operate TTS.

If TTS has been disabled and you have solved the problems that led to its disabling, use the `ENABLE TTS` command to enable TTS again. Type the following:

```
ENABLE TTS <Enter>
```

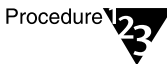
### Automatically Backing Out of Incomplete Transactions

Use this procedure to enable the server to automatically back out of any incomplete transactions, without being prompted.



#### Prerequisites

- TTS enabled



#### Procedure

1. **At the server console prompt, load either `SERVMAN` or `MONITOR`.**

```
LOAD SERVMAN | MONITOR <Enter>
```



You can also set parameters with the `SET` command. See “`SET`” in *Utilities Reference*.

2. **Choose “Server Parameters” from the “Available Options” menu.**
3. **Choose “Transaction Tracking” from the “Categories” menu.**

4. Choose “Auto TTS Backout Flag” from the “Transaction Tracking” menu.
5. Press <Enter> to change the value to ON.
6. Press <Esc> twice to reach the “Update Options” menu.
7. Choose “Update AUTOEXEC.NCF and STARTUP.NCF Now” from the “Update Options” menu.

A window appears, indicating the path to the STARTUP.NCF file.

8. Press <Enter> to update the file.
9. When you want the changes to take effect, reboot the server.

## Keeping a Log of Backed-Out Data

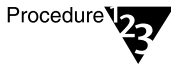
Use this procedure to keep a log (TTSS\$LOG.ERR on volume SYS:) of all data that is backed out by TTS.

### Prerequisites



- TTS enabled

### Procedure



1. At the server console prompt, load either **SERVMAN** or **MONITOR**.

```
LOAD SERVMAN | MONITOR <Enter>
```



You can also set parameters with the SET command. See “SET” in *Utilities Reference*.

2. Choose “Server Parameters” from the “Available Options” menu.
3. Choose “Transaction Tracking” from the “Categories” menu.
4. Choose “TTS Abort Dump Flag” from the “Transaction Tracking” menu.
5. Press <Enter> to change the value to ON.

6. Press <Esc> twice to reach the “Update Options” menu.
7. Choose “Update AUTOEXEC.NCF and STARTUP.NCF Now” from the “Update Options” menu.

A window appears, indicating the path to the AUTOEXEC.NCF file.

8. If desired, press <Enter> to update the file.

The system writes the parameters to the AUTOEXEC.NCF file or updates the parameters if they are already in the file.

If you do not update the AUTOEXEC.NCF file, the parameter changes last only until the server is rebooted.

## Mirroring and Duplexing to Protect Data

NetWare 4 enables you to protect data from hard disk failure by duplicating, or “mirroring,” one hard disk’s data on one or more other hard disks.

If a mirrored hard disk fails and cannot be accessed by the server, you can unmirror the hard disks and salvage the volume from the functional disk.

How to mirror or duplex hard disks is explained under “Mirroring and Duplexing a Hard Disk” on page 514. How to recover data from a mirrored disk is explained in the next section, “Recovering Data from an Unmirrored (Out of Sync) Hard Disk” on page 537.

## Recovering Data from an Unmirrored (Out of Sync) Hard Disk

Once a hard disk is unmirrored, its status is listed as either “Not Mirrored” or “Out of Sync” on the “Disk Partition Mirroring Status” list. To display this list, load INSTALL, select “Disk Options,” and then choose “Mirror/Unmirror Disk Partitions.”

When a hard disk is listed as “Out of Sync,” the operating system does not recognize any volume information on it. Use this procedure to recover data from an “Out of Sync” partition.



## Procedure

1. **At the server console prompt, type**

```
LOAD INSTALL <Enter>
```

2. **Select “Disk Options” in the “Installation Options” menu.**
3. **Select “Mirror/Unmirror Disk Partitions” in the “Available Disk Options” menu.**
4. **Select the “Out of Sync” partition and press <F3>.**

The following warning may appear if another volume segment with the same name exists on another disk:

```
Warning! The selected partition contains "volume  
<name> segment <number>" and that volume is  
already defined.
```

```
<Press ESCAPE To Continue>
```

- 4a. **Press <Esc> and respond “Yes” to the “Rename the Volume Segment?” prompt.**
- 4b. **Enter a unique name for the new volume segment.**
5. **Respond “Yes” to the prompt to salvage the volume segment.**

Now the segment can be mounted as an independent volume.

## Using Remote Console to Manage a Server

The NetWare 4 operating system allows you to use a workstation as a server console when needed. A workstation functioning as a console is called a *remote console*.

A remote console gives you greater server security because you can lock servers in a safe place and remove the keyboards and monitors. You can then start a remote console session from a workstation whenever you need to accomplish console tasks.

When finished, you can exit the remote console session so the computer functions as a workstation again.



You can perform the following functions from a remote console:

- ◆ Use console commands as you would at the server console.
- ◆ Scan directories and edit text files in both NetWare and DOS partitions on a server.
- ◆ Transfer files to, but not from, a server.
- ◆ Bring down or reboot a server.
- ◆ Install or upgrade NetWare.

This section describes how to establish a remote console session and how to accomplish some essential management tasks from a remote console.

## Understanding Connection Types

Remote console sessions can be run on the network or through a modem.

- ◆ A network connection is called a direct connection.
- ◆ A connection through a modem or null modem cable is called an asynchronous connection. A null modem cable is a direct serial connection between two computers, as opposed to a network connection.

## Running a Remote Console Session Through a Direct Connection

To run a remote console session over a direct connection you must do the following:

1. Load the REMOTE NLM and RSPX NLM on the server.
2. Run RCONSOLE.EXE from the workstation to access the server.

Each of these tasks is described in the following procedures

## Loading the REMOTE NLM and RSPX NLM on the server

Checklist



### Prerequisites

- The REMOTE NLM, the remote password, and the RSPX NLM. You don't need the Supervisor object right to the remote server because RCONSOLE does not use Novell Directory Services.
- A server running NetWare 3.11 or a later version
- 75 KB of available memory

### Procedure

Procedure



#### 1. At the server console prompt, type

```
LOAD REMOTE [password] <Enter>
```

If you do not specify a password as a parameter, you are prompted to enter one. A password is required. The password you establish here must be entered again when the remote console session is established.

#### 2. At the server console prompt, type

```
LOAD RSPX <Enter>
```

You must load the RSPX NLM before you can run a remote console session through a direct connection.

When you load RSPX, you have the option to require packet signatures to ensure security. The default is ON, which means that packet signatures are required.

However, packets with signatures are not compatible with NetWare 3.11. If you run NetWare 3.11, set packet signatures OFF when you load RSPX. To set packet signatures OFF, type

```
LOAD RSPX SIGNATURES OFF <Enter>
```

For more information about packet signatures, see "Preventing Packet Forgery" on page 521.

## Running RCONSOLE.EXE from a Network Workstation

Once the REMOTE NLM and RSPX NLM are loaded on the server, you can start a remote session from a workstation by executing the RCONSOLE.EXE file and specifying the remote password. You don't need the Supervisor object right to the remote server, since RCONSOLE does not use Novell Directory Services.

The following procedure explains how to run RCONSOLE from a network drive. You can also run RCONSOLE from your local hard drive.

### Prerequisites

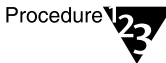


- A workstation running DOS 3.30 or later version
- A search drive mapped to the directory where the RCONSOLE.EXE file is located (usually SYS:SYSTEM)
- 300 KB of available memory on the workstation
- The remote console password



In NetWare 4.11, when you run RCONSOLE, you must enter the password that you establish when you load REMOTE.NLM. The supervisor password does not allow remote access, unless it is set as the password when you load REMOTE.NLM.

### Procedure



#### 1. Log in to the network.

##### 1a. If you are logging in to a NetWare 4 network, type

```
LOGIN username <Enter>
```



If you do not have a context specified in your NET.CFG file, see "LOGIN" in *Utilities Reference*.

##### 1b. If you are logging in to a NetWare 3 server, type

```
LOGIN servername/username <Enter>
```

Enter your password when prompted.

2. **Make sure you have a drive mapped to the directory where the RCONSOLE.EXE file is located (usually SYS:SYSTEM).**

If you don't have a drive mapped, type

```
MAP S16:=sys:system <Enter>
```

3. **Start RCONSOLE by completing one of the following steps:**

- 3a. **If you know the name of the server, type the following command, and then skip to Step 6:**

```
RCONSOLE servername <Enter>
```

- 3b. **If you know part of the server name, type the partial name followed by an asterisk:**

```
RCONSOLE partial_servername*
```

Select a server from the displayed list and then continue with Step 6.

- 3c. **If you do not know the name of the server, type the following command, and then continue with Step 4 and Step 5:**

```
RCONSOLE <Enter>
```

4. **Select SPX from the "Connection Type" menu.**

A list of servers available for a remote console session appears.

5. **Connect to the server, using one of the following methods:**

- 5a. **Select a server from the list, and then go to Step 6.**

- 5b. **Type the name of the server, and then go to Step 6.**

**5c. If you know the IPX internal network number of the server, do the following:**

- ◆ Press <Insert>.
- ◆ Enter the IPX internal network number in hexadecimal notation, then continue with Step 6.

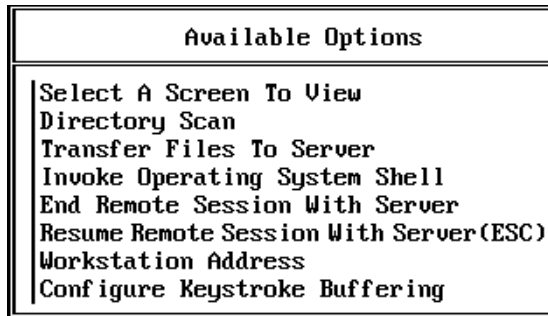
**6. Type the server's remote console password at the prompt.**

This is the password you established when you loaded REMOTE.NLM.

The remote console session is now open. The workstation screen displays the same information you would see on the server console screen.

**7. To view a menu of options for the remote session, press <Alt>+<F1>.**

The remote console "Available Options" menu appears.



During an RCONSOLE session you can use the keys described in Table 7-3. All the other keys function as if you were at the server console.

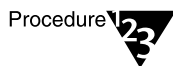
**Table 7-3**  
**RCONSOLE Keys**

Key	Description
<Alt>+<F1>	Access the “Available Options” menu.
<Alt>+<F2>	Exit Remote Console.
<Alt>+<F3>	Cycle backward through the current console screens.
<Alt>+<F4>	Cycle forward through the current console screens.
<Alt>+<F5>	Show the address of the workstation you are using for this session.
<F1>	Display Remote Console help when the Remote Console “Available Options” menu is on the screen. (When another screen is showing, this key displays the relevant server help information.)

## Ending a Remote Console Session

You can exit the remote session from either the “Available Options” menu or the console prompt.

### Procedure



1. From the “Available Options” menu, select “End Remote Session With Server,” or from the console prompt, press <Alt>+<F2>.
2. Choose “Yes” from the “Quit Remote Console Session?” box.

The next screen to appear depends upon how you invoked RCONSOLE.

If you specified the name of a specific server as a parameter when you executed RCONSOLE, the remote session with that server is ended.

If you selected the server from a list of available servers, the available servers list is redisplayed. To exit from the list of servers, press <Esc> and then select “Yes” from the “Exit Remote Console?” menu.

## Additional Information

For more information about	See
Passwords	"Password" in <i>Concepts</i>
RCONSOLE.EXE	"RCONSOLE" in <i>Utilities Reference</i>
Remote console	"Remote console" in <i>Concepts</i>

## Running a Remote Console Session Over a Modem

This section explains how to run a remote console session over an asynchronous connection—a connection using a modem or null modem cable. To run the session, you must complete the following steps:

1. On the server, load REMOTE.NLM, AIO.NLM, and RS232.NLM. Also load the appropriate communications port driver, such as AIOCOMX.NLM.
2. Create a callback file, if desired.
3. Load necessary workstation files.
4. Execute RCONSOLE.EXE from the workstation and, on first execution, configure the modem.

Each of these tasks is explained in the following procedures.

## Loading Modules on the Server



### Prerequisites

- The following NLM files:
  - REMOTE.NLM
  - RS232.NLM
  - AIO.NLM
- A communications port driver such as AIOCOMX

## Procedure

### 1. At the server console prompt, type

```
LOAD REMOTE [password] <Enter>
```

Enter the password you want to use when accessing the server from the remote workstation. A password is required.

### 2. Complete the following steps to load the communications interface module and driver:

#### 2a. Load the communications port interface module by typing

```
LOAD AIO <Enter>
```

#### 2b. Load the communications port driver by typing

```
LOAD AIOCOMX <Enter>
```

This driver is provided with NetWare. You can replace it with an equivalent driver if you choose.

#### 2c. Load the asynchronous connection NLM by typing

```
LOAD RS232 [comm_port] [modem_speed] [N] [C]  
<Enter>
```

Replace *comm\_port* with the communications port number (1 or 2).

Replace *modem\_speed* with the baud rate (2400, 4800, or 9600).

Use the “N” parameter if you are using a null modem cable.

Use the “C” parameter if you want to use the callback option. The callback option is explained in the next procedure.



## Creating a Callback List

A callback list enables you to create a list of authorized modem numbers that can be used to access the server.

When a connection attempt is made, the server notes the number of the modem that is calling and then terminates the connection. The server then compares the number to the numbers in the callback list.

If the number is in the list, the server calls the modem at that number and reestablishes the connection. If it is not in the list, the server ignores the call.

If you included the callback parameter when you loaded RS232.NLM in the preceding section (“Loading Modules on the Server” on page 545), complete the following steps:

### Procedure



- 1. Create a CALLBACK.LST file in the SYS:SYSTEM directory on the server.**

Use a text editor or the EDIT utility to create the file. If you need help creating the file, see “Editing Text Files from the Server Console” on page 418.

- 2. In the file, enter a list of modem numbers that are authorized to start a remote console session.**

For example, you might list three modem numbers:

```
18015552257  
5554321  
4269
```

The first number authorizes a modem for a long distance number (with an area code), the second number is a local telephone number, and the third number is for a modem where only the extension number is required.

- 3. Save the text file.**

## Preparing the Workstation

### Procedure



**Prepare the workstation as a remote console by creating a directory and copying the following RCONSOLE run files to it:**

RCONSOLE.EXE  
RCONSOLE.HEP  
RCONSOLE.MSG  
IBM\_RUN.OVL  
\_RUN.OVL  
IBM\_AIO.OVL  
\_AIO.OVL  
TEXTUTIL.HEP  
TEXTUTIL.IDX  
TEXTUTIL.MSG

It doesn't matter where you place the directory or what you name it. The run files come with your NetWare system.

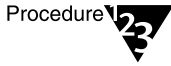
## Running RCONSOLE.EXE and Configuring the Modem

### Prerequisites



- A workstation with a Hayes\*-compatible modem (2400, 4800, or 9600 baud) or a null modem cable connected to the server
- 300 KB of available memory on the workstation
- REMOTE.NLM, AIO.NLM, RS232.NLM, and the communications port driver (such as AIOCOMX) loaded on the server
- All necessary files loaded on the workstation
- The remote console password

## Procedure



1. **At the workstation, change to the directory you created for the remote files (described in the preceding section, “Preparing the Workstation” on page 548) and type**

`RCONSOLE <Enter>`

2. **Select “Asynchronous” from the “Connection Type” menu.**
3. **If this is the first session from this workstation, select “Configuration” from the “Asynchronous Options” menu, and then continue with Step 4. Otherwise, skip to Step 7.**
4. **In the “Current Modem Configuration” window, set the options according to your modem and workstation specifications.**

- 4a. **Use the arrow keys to highlight a field, and press <Enter>.**

Either the cursor becomes active in the field or a selection list is displayed.

- 4b. **If the cursor is active in the field, type in the appropriate information. If a selection list is displayed, select the appropriate item. Press <Enter>.**



The “UserID” and the “Call Back” fields must be filled in.

Choose any string for the UserID. For example, you may use your name or your phone number. This ID is displayed on the server console during the remote session.

In the “Call Back” field, enter the phone number you are calling from. If the “callback” option is used, this number must be in the callback list.

5. **Press <Esc> to exit the window.**
6. **Choose “Yes” from the “Save Changes?” box to save your configuration.**
7. **Choose “Connect to Remote Location” from the “Asynchronous Options” menu.**

A list of available servers is displayed.

8. **Select a server.**

If you are using the callback option, the server terminates the connection and compares the number in the modem configuration file with the numbers in the callback list.

If the number in the modem configuration file is in the list, the server dials the number to establish the connection and then displays the console prompt. If the number is not in the list, the server displays an error message.

9. **Once the console prompt is displayed, press <Alt>+<F1> to view the “Available Options” menu for the remote console session.**

During the RCONSOLE session, you may use the keystrokes shown in Table 7-3 on page 544. All other keys function as if you were at the server console.



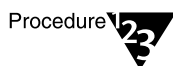
RCONSOLE does not provide guaranteed packet delivery. When sending or receiving packets from a server with extensive disk or LAN activity, RCONSOLE may “time out.”

If this happens, you receive a “No response from server” or an “Unable to send request to server” message. If you receive one of these messages, retry the operation.

## Ending a Remote Console Session

You can exit the remote session from either the “Available Options” menu or the console prompt.

### Procedure



1. **From the “Available Options” menu, select “End Remote Session,” or from the console prompt, press <Alt>+<F2>.**
2. **Select “Yes” from the “Quit Remote Console Session?” box.**

## Loading Remote Modules on Bootup

You can put commands in the AUTOEXEC.NCF file to load remote console modules each time the server is booted.

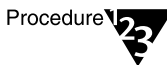
Since these modules require the remote password, you may choose to place an encrypted version of the password in the file, too. The encrypted password secures the server console by hiding the remote console password from users who access the AUTOEXEC.NCF file.

The following procedure explains how to set an encrypted password and what commands to place in the AUTOEXEC.NCF file.



### Prerequisites

- The remote console password



### Procedure

1. **To encrypt a password, type the following:**

```
LOAD REMOTE <Enter>
```

2. **Execute the following command:**

```
REMOTE ENCRYPT <Enter>
```

The server prompts you to enter the password to be encrypted.

3. **Enter the password you want to use for remote console sessions.**

The system displays the encrypted value and a message asking if the LOAD REMOTE command should be written to the SYS:SYSTEM\LDREMOTE.NCF file.

**4. Respond “Yes.”**

When you respond “Yes,” the system places a LOAD REMOTE command into this file with the encrypted password as a parameter.

You can execute this file whenever you want to load the REMOTE NLM, or you can place the command to execute the file into your AUTOEXEC.NCF file. This feature saves you from having to type in the encrypted password, which is often quite long.

**5. Use either INSTALL or EDIT to open the AUTOEXEC.NCF file.**

For information about editing .NCF files, see “Creating or Editing a Server Batch (.NCF) File” on page 416.

**6. Move the cursor to the end of the file and type the following:**

**LDREMOTE**

**6a. For direct connections, type the following after LDREMOTE:**

**LOAD RSPX**

**6b. For asynchronous connections, type the following after LDREMOTE:**

**LOAD AIO  
LOAD AIOCOMX**

The AIOCOMX driver is provided with NetWare. You can replace it with an equivalent driver if you choose.

**LOAD RS232 [comm\_port] [modem\_speed] [N] [C]**

Replace *comm\_port* with the communications port number (1 or 2).

Replace *modem\_speed* with the baud rate (2400, 4800, or 9600).

Use the “N” parameter if you are using a null modem cable.

Use the “C” parameter if you want to use the callback option. For information and instructions, see “Creating a Callback List” on page 547.

**7. Exit and save the AUTOEXEC.NCF file.**

The server will now automatically load the necessary remote modules whenever it is booted.

### Additional Information

For more information about	See
EDIT utility	"EDIT" in <i>Utilities Reference</i>
LOAD command	"LOAD" in <i>Utilities Reference</i>
RCONSOLE utility	"RCONSOLE" in <i>Utilities Reference</i>
REMOTE utility	"REMOTE" in <i>Utilities Reference</i>
RS232 utility	"RS232" in <i>Utilities Reference</i>
RSPX utility (including the Packet Signatures option)	"RSPX" in <i>Utilities Reference</i>

## Upgrading Files on a Remote Server

You can use a remote console to copy new NetWare files to a server. Files can be copied from diskettes, a CD-ROM drive, a local drive, or from a network directory. To copy new NetWare files to volume SYS: on a remote server, follow these steps.

### Prerequisites



- NetWare diskettes or CD-ROM drive, if needed.
- Workstation and server prepared for remote console sessions. See "Running a Remote Console Session Through a Direct Connection" on page 539 and "Running a Remote Console Session Over a Modem" on page 545.



## Procedure

### 1. Start a remote console session with the server.

To start a session over a LAN, see “Running RCONSOLE.EXE from a Network Workstation” on page 541.

To start a session over a modem connection, see “Running RCONSOLE.EXE and Configuring the Modem” on page 548.

### 2. At the remote console, type

```
LOAD INSTALL <Enter>
```

### 3. Choose “Copy Files Option” from the “Installation Options” menu.

### 4. Choose a remote path.

This is the path from which the files will be installed. You may load files from NetWare diskettes, a local drive, a CD-ROM, or a network drive.

### 5. Follow the subsequent prompts.

## Installing or Reconfiguring Applications on a Remote Server

You can use a remote console session to install or reconfigure Novell or third-party products on a remote server. Follow these steps.

### Prerequisites



- Application diskettes, if necessary.
- Workstation and server prepared for remote console sessions. See “Running a Remote Console Session Through a Direct Connection” on page 539 and “Running a Remote Console Session Over a Modem” on page 545.





## Procedure

**1. Start a remote console session with the server.**

To start a session over a LAN, see “Running RCONSOLE.EXE from a Network Workstation” on page 541.

To start a session over a modem connection, see “Running RCONSOLE.EXE and Configuring the Modem” on page 548.

**2. At the remote console, type**

```
LOAD INSTALL <Enter>
```

**3. Choose “Product Options” from the “Installation Options” menu.**

**4. Select “View/Configure/Remove Installed Products” from the “Other Installation Actions” menu.**

A list of currently installed products (if any) appears.

**5. To reconfigure an installed product, select that product and press <Enter>. Follow screen instructions.**

**6. To install a new product, press <Insert>.**

A message states that the product will be installed from the A: drive, unless otherwise indicated.

**7. If necessary, insert the product installation diskette into the drive.**

**8. Press <Enter> to accept the default, drive A:, or press <F3> to enter a different installation source path.**

**9. Follow the prompts to install the product.**

# Rebooting a Remote Server

You can reboot a NetWare server from a remote console by first modifying the server's AUTOEXEC.BAT file and then executing another .NCF file that you create for this purpose.

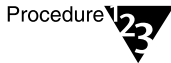
## Preparing the Server

### Prerequisites



- Commands in the server AUTOEXEC.NCF file that load the remote modules. See "Loading Remote Modules on Bootup" on page 551.

### Procedure



- 1. To automatically reboot the server, put commands to change to the NetWare 4.11 directory and execute SERVER.EXE in the server's AUTOEXEC.BAT file.**

For example, if the SERVER.EXE file is in the NET\_4.11 directory on drive C:, put the following lines in the server's AUTOEXEC.BAT file:

```
CD C:\NET_4.11  
SERVER.EXE
```

- 2. Start a remote console session with the server.**

To start a session over a LAN, see "Running RCONSOLE.EXE from a Network Workstation" on page 541.

To start a session over a modem connection, see "Running RCONSOLE.EXE and Configuring the Modem" on page 548.

- 3. Load the EDIT NLM on the server by typing**

```
LOAD EDIT <Enter>
```

4. **Create an .NCF file and include the following commands in the order given:**

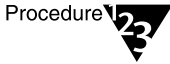
```
REMOVE DOS  
DOWN  
EXIT
```

See “Creating or Editing a Server Batch (.NCF) File” on page 416.

5. **Save the file in the SYS:SYSTEM directory.**

## Rebooting the Server

### Procedure



1. **Start a remote console session with the server.**

To start a session over a LAN, see “Running RCONSOLE.EXE from a Network Workstation” on page 541.

To start a session over a modem connection, see “Running RCONSOLE.EXE and Configuring the Modem” on page 548.

2. **Send a message to all users to inform them that the server is going down.**

See “Sending Console Messages to Workstations” on page 402 if you need help sending a message.

3. **At the system prompt on the remote console, enter the name of the .NCF file you created.**

This reboots the server. The keyboard is disabled for a few minutes while the file is processed.

When the file has finished processing, a “connection is lost” message appears.

4. **Press <Esc> to exit the remote session.**
5. **Open a new remote console connection with the server.**

# Administering Accounting

This section describes how to set up NetWare accounting, calculate charge rates for using server resources, and view various system statistics.

## Setting Up Accounting

Accounting allows you to monitor NetWare server usage and charge users for server resources.

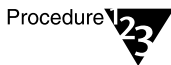
### Setting Up Accounting Using the NetWare Administrator

#### Prerequisites



- A workstation running Windows 3.1x or OS/2 v2.x and NetWare Administrator.
- 6 MB of available memory on the Windows workstation, or 12 MB of available memory on the OS/2 workstation.
- Supervisor object right to the Server object where you are setting up accounting.

#### Procedure



1. **Start NetWare Administrator.**
2. **Select the Server object you want to set up accounting for.**
3. **From the “Object” menu, Choose “Details.”**
4. **From the bottom of the dialog box, choose “Accounting.”**
5. **To confirm that you want to install accounting on this server, choose “Yes.”**

Accounting page buttons appear on the right side of the dialog box with the other page buttons.

6. **Use the accounting buttons to edit the accounting pages.**
7. **Choose “OK.”**

## Setting Up Accounting Using NETADMIN

Checklist



### Prerequisites

- A workstation running DOS 3.30 or later.
- A minimum of 512 KB of memory available on the workstation.
- Supervisor object right to the Server object you want to set up accounting for.

Procedure



### Procedure

1. **At the workstation prompt, type**  
`NETADMIN <Enter>`
2. **From the “NetAdmin Options” menu, choose “Manage Objects.”**
3. **Select the Server object you want to set up accounting for by completing the following steps:**
  - 3a. **If the server appears on the list, select it and press <F10>.**
  - 3b. **If the server is not on the list, browse the directory by selecting objects and pressing <Enter> until you see the server you want. Select it and press <F10>.**
4. **Choose “View or Edit Properties of this Object.”**
5. **Choose “Accounting.”**
6. **From the “Install Accounting” prompt, choose “Yes.”**
7. **Choose “Accounting Servers.”**
8. **Press <Insert>.**
9. **From the list of possible servers, choose “NetWare Server.”**
10. **Enter the name of the server, or press <Insert> and select a server from the list.**

11. To return to the “Accounting Options” menu, press <Esc>.
12. Choose the options you want to set up from the menu.  
Press <F1> if you need help with any of the options.
13. To exit NETADMIN, press <Alt>+<F10>.

## Calculating Charge Rates for Accounting

Charge rates for using server resources are specified as multipliers and divisors. To set the charge amount to “No Charge,” enter 0 as the multiplier. Use the following formula to calculate a charge rate:

$$\frac{\text{CHARGE (charge rate multiplier)}}{\text{ESTIMATED USAGE (charge rate divider)}} = \text{CHARGE RATE}$$

For example, if you want to charge \$200 per month for server disk storage, and there are usually 100,000 blocks used each month on your hard drive:

- ◆ 20,000 would be the multiplier (\$200 in cents)
- ◆ 100,000 would be the divisor (disk block usage per month)
- ◆ Therefore, users would be charged two-tenths of one cent per disk block used.

$$\frac{20,000 \text{ cents}}{100,000 \text{ blocks read}} = 1 \text{ cent} / 5 \text{ blocks read}$$

## Viewing Accounting Totals

The ATOTAL utility provides a total for the accounting services used on your network. ATOTAL compiles information from the system accounting records and lists the following:

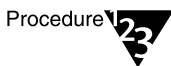
- ◆ Total connect time in minutes
- ◆ Total service requests
- ◆ Total blocks read
- ◆ Total blocks written
- ◆ Total disk storage in blocks per day

### Prerequisites



- A workstation running DOS 3.30 or later, or OS/2 v2.x.
- Accounting set up on the NetWare server. (See “Setting Up Accounting” on page 558.)
- Supervisor object right to the Server object you want to see accounting information for.

### Procedure



1. **Change to the SYS:SYSTEM directory.**

**To view daily and weekly totals for accounting services, type**

```
ATOTAL <Enter>
```

2. **To redirect ATOTAL data to a file, type**

```
ATOTAL > filename <Enter>
```





NetWare® Symmetric MultiProcessing (SMP) software allows multiprocessing-enabled NetWare Loadable Module™ (NLM™) programs to run on a multiprocessor computer and take advantage of the increased processing power multiprocessing provides.

NetWare SMP also improves NetWare performance because it allows LAN interrupts to be distributed across multiple processors.

When you install or upgrade to NetWare 4.11, the installation process determines whether your server contains multiple processors. If it does, the installation process gives you the option of installing NetWare SMP. If you choose not to install SMP during NetWare installation, you can install it later.

Under SMP, software designed for a multiprocessor computer runs across all the processors in the machine. NetWare features and third-party software that are not designed for a multiprocessor computer are executed on processor 0, where they function as they do on a uniprocessor (single processor) system. When threads are executed by other processors, processor 0 is left with more bandwidth.

This provides greater system speed and performance, even for applications that are not multiprocessing-enabled.

NetWare SMP provides these benefits:

- ◆ Increased processing power.
- ◆ Better network performance.
- ◆ Support for up to 32 processors, depending on the hardware platform.
- ◆ Fault tolerance for systems with Advanced Programmable Interrupt Controllers (APICs). If any processor (except processor 0) fails, the server continues to function.
- ◆ An application programming interface (API) for software developers, explained in the *NetWare SMP Software Developer Kit*.



For information about Novell® software developer kits, call 1-800-RED-WORD (1-800-733-9673) or 1-801-861-5281, or E-mail [devprog@novell.com](mailto:devprog@novell.com).

NetWare SMP looks and functions just like native NetWare 4.11, but provides additional statistics through MONITOR.NLM, as well as additional SET parameters.

The MONITOR.NLM statistics are explained under “Monitoring SMP Performance” on page 573. SET parameters are explained under “Using SMP SET Parameters” on page 586.

# Installing and Uninstalling NetWare SMP

You can install NetWare SMP

- ◆ During initial installation of NetWare 4.11. See *Installation*.
- ◆ After initial installation of NetWare 4.11. See the following section, “Installing NetWare SMP.”

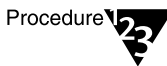
To uninstall NetWare SMP, see “Uninstalling NetWare SMP” on page 566.

## Installing NetWare SMP



### Prerequisites

- NetWare 4.11 installed on the server



### Procedure

1. **Load INSTALL.NLM at the server console prompt by typing**  
`LOAD INSTALL <Enter>`
2. **From the “Installation Options” menu, choose “Multi CPU Options.”**
3. **From the “SMP Installation Options” menu, choose “Select a Platform Support Module.”**

A selection list of platform support modules appears. Below the list is a window that displays a description of the module that is currently highlighted.

4. **Use the arrow keys to highlight the module that matches your hardware. Press <Enter>.**

A message prompts you to confirm your selection.

5. **Choose “Yes” to confirm the selection.**

A message states that NetWare SMP has been installed but will not be loaded until you restart the server.

6. Press <Enter> to clear the message.
7. Press <Alt>+<F10> to exit INSTALL.
8. Restart the server to load SMP.

## Uninstalling NetWare SMP

### Procedure



1. Load INSTALL.NLM at the server console prompt by typing  
`LOAD INSTALL <Enter>`
2. From the “Installation Options” menu, choose “Multi CPU Options.”
3. From the “SMP Installation Options” menu, choose “Uninstall SMP.”

A message states that NetWare SMP has been uninstalled but will not be unloaded until you restart the server.

4. Press <Enter> to clear the message.
5. Press <Alt>+<F10> to exit INSTALL.
6. Restart the server to unload SMP.

# Multiprocessing Overview

The following sections

- ◆ Summarize the differences between uniprocessor and multiprocessor systems
- ◆ Describe the architecture of NetWare SMP
- ◆ Introduce basic multiprocessing terms you will see in NetWare SMP windows and in system messages

## Uniprocessing vs. Multiprocessing

A *uniprocessor* server often appears to process multiple applications at the same time. In reality, the single processor executes only one stream of instructions on one stream of data, even though the instructions and the data may apply to different applications.

Despite high processing speeds, there is a limit to how much one processor can execute, since it can execute only one task at a time.

In a *multiprocessor* server, multiple processors operate at the same time. Each processor executes a separate instruction stream on a separate stream of data, providing true simultaneous execution of multiple tasks.

In a *symmetric multiprocessing* system, the operating system balances the workload evenly among all the processors so that no processor remains idle. The result is faster performance and increased system capacity.

## Multithreaded Applications

Applications can be written to take advantage of a multiprocessing system's parallel architecture. In such applications, individual processes are broken down into smaller pieces, called *threads*.

The different threads from one process can be executed on different processors at the same time, greatly increasing the speed at which the overall process is executed.

The results of the separate thread operations are combined to complete the process. Applications designed in this way are called multithreaded applications.

## Architecture of NetWare SMP

NetWare SMP is a *tightly coupled symmetric* system, defined as follows:

- ◆ A *tightly coupled* system is one in which all processors share the same memory, interrupts, and devices.
- ◆ A *symmetric* system is one in which any processor can handle any task; the processors are not dedicated to specific tasks.

Tightly coupled symmetric systems provide centralized control and increased system speed.

The SMP system contains two kernels: the native NetWare kernel and the SMP NetWare kernel. These two kernels are sometimes called *schedulers*, because they schedule work across the processors.

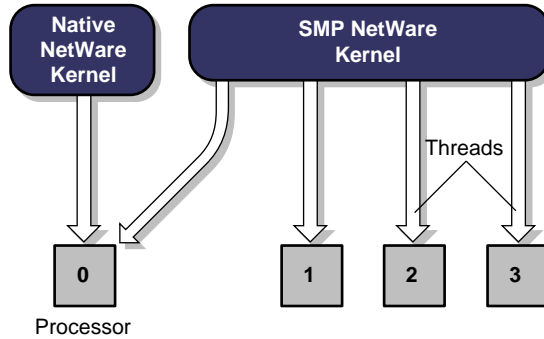
### The Native NetWare Kernel

The native NetWare kernel executes the parts of native NetWare that are not multithreaded, as well as any third-party software that is not multithreaded. The native NetWare kernel always executes threads on processor 0. It cannot use the other processors.

The native NetWare kernel also executes any SMP threads that must access NetWare data, as explained in “Thread Migration” on page 571.

## The SMP NetWare Kernel

The SMP NetWare kernel executes all multithreaded processes, such as LAN drivers and multithreaded third-party software. This kernel balances the multithreaded processes across all the processors, including processor 0, as needed.



To increase efficiency, the SMP NetWare kernel schedules a thread on the processor that last executed the same thread. This processor might have some of the thread's code left in its cache and, if so, can process the thread faster.

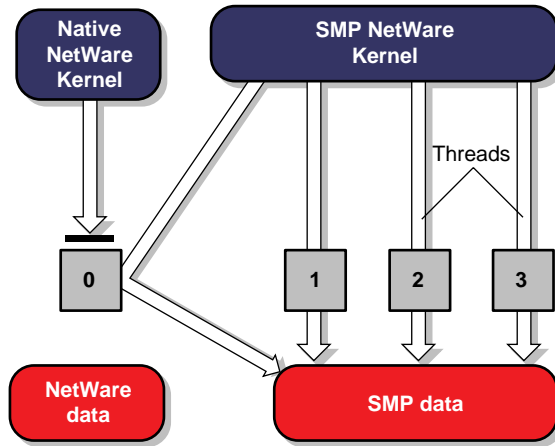
If the work becomes unevenly distributed, the SMP NetWare kernel balances the load again among all the processors.

## Preemption

The native NetWare kernel executes threads on processor 0, but the SMP NetWare kernel may also schedule threads on processor 0, thus competing for the same processor resources.

By default, when the SMP NetWare kernel must execute a thread on processor 0, it stops any native NetWare thread currently running there. This is called *preemption*.

In the following figure, the SMP NetWare thread preempts the native NetWare thread.



However, you can use a SET parameter, called SMP NetWare Kernel Mode, to limit the SMP kernel's access to processor 0. For example, if you run many applications that are not multithreaded, you might want these applications to have more of processor 0's time.

You can set the SMP NetWare Kernel Mode parameter so that NetWare threads have priority over the SMP threads on processor 0, or so that the SMP NetWare kernel has no direct access to processor 0 at all. For information about setting this parameter, see "Using SMP SET Parameters" on page 586.



## Thread Migration

In a uniprocessing environment, NetWare data does not need to be protected against corruption because there is no possibility that more than one process will access the data at a time.

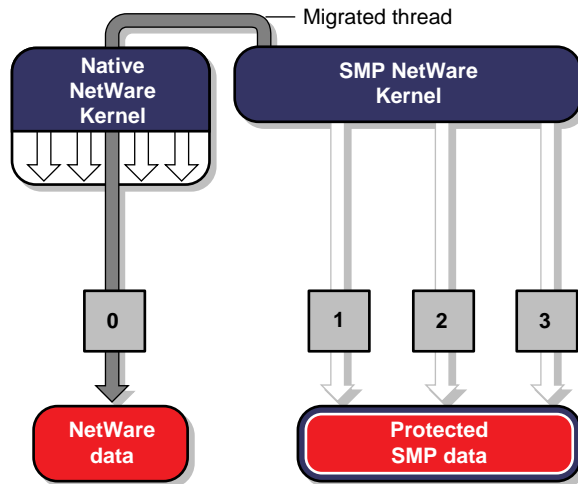
However, in the multiprocessing environment, multiple threads running on multiple processors need to access the unprotected NetWare data. If multiple threads were to access the same data at the same time, the data could become corrupted.

To avoid corrupting the unprotected NetWare data, NetWare SMP uses a mechanism called *thread migration*. Thread migration forces all threads that need access to NetWare data to go through the native NetWare kernel.

The native NetWare kernel can process only one thread at a time (because it has access to only one processor, processor 0). Therefore, there is no danger that multiple threads will access the NetWare data simultaneously.

The native NetWare kernel acts as a kind of gateway that allows only one thread at a time to access the NetWare data.

In the following figure, the SMP NetWare kernel migrates a thread to the native NetWare kernel so the thread can access NetWare data.



Thread migration is handled automatically by NetWare SMP.

## Mutual Exclusion Locks (Mutexes)

While NetWare data structures are protected by the thread migration process discussed in the previous section, the SMP system contains another class of data: SMP data.

SMP data is protected by locking mechanisms called *mutual exclusion locks*, or *mutexes*. A mutex is a software procedure associated with a data structure that prevents a thread from accessing the data structure if it's already in use. Mutexes are of various types, including spin, sleep, and barrier.

Each SMP data structure has a mutex associated with it. A thread must acquire the mutex to access the data. The mutex allows only one thread to access the data at a time. An attempt to acquire a mutex is called a *lock assertion*.

When multiple threads attempt to acquire a mutex at the same time, a *lock collision* occurs.

MONITOR.NLM screens include mutex information among their display of SMP statistics.

# Monitoring SMP Performance

After you install NetWare SMP, MONITOR.NLM displays multiprocessing statistics that help you evaluate your SMP server's performance.

SMP statistics appear both in the MONITOR "General Information" window and in windows accessed through the MONITOR "Multiprocessor Information" menu item.

Unless otherwise noted, statistics are updated at one-second intervals.

## Assessing the Statistics

The significance of SMP statistics depends upon many factors, including how many processors are installed, the amount of LAN traffic, the size of applications, and the suitability of applications for a multiprocessing environment.

Therefore, it is impossible to state that certain values indicate system problems.

For example, if you have more than one network board installed and you notice a combined utilization of 50% with slower server performance, you might need to add additional processors to increase server capacity.

However, if utilization is 50% but LAN traffic is low, and your server's speed and performance haven't declined significantly, you might not need additional processors. You might simply be running a large application that uses processor resources intensively but efficiently.

We recommend that you become familiar with the statistics while your system is performing well. Then, when you add new applications or processors, compare statistics to evaluate changes in performance.

If your system begins to perform poorly, look for changes in the statistics to help determine the source of the problem.

## SMP Statistics in the "General Information" Window

Two SMP statistics appear in the MONITOR "General Information" window.

Statistic	Description
Active Processors	Number of enabled processors detected by SMP. This number does not include processors that are installed but not enabled.
Utilization	The average utilization of all active processors. Processor utilization is calculated every two seconds.



Note

The Utilization statistics found under the “Processor Utilization” and “Scheduling Information” options of the MONITOR menu refer only to processor 0. To see utilization information for multiple processors, select the “Multiprocessor Information” option, discussed in the next section.

## Statistics Accessed through the “Multiprocessor Information” Option

After you install NetWare SMP, the MONITOR “Available Options” menu includes a new option, “Multiprocessor Information.” When you select this option, the server displays the “Information for All Processors” window and the “Multiprocessor Options” menu.

Information For All Processors	
Total processors:	4
Active processors:	4
Combined lock assertions:	480
Combined lock collisions:	0
Maximum lock wait:	0
Combined utilization:	16%

Available Options
Multiprocessor Options
Information by processor MUTEX information Thread information
Multiprocessor information

The “Multiprocessor Options” menu includes the following items.

Option	Displays information about
Information by Processor	Each active processor
MUTEX Information	Locks
Thread Information	Active threads

When you choose a menu item, a window containing the appropriate information appears. If the information fills more than one screen, press

- ◆ <PageDown> or <PageUp> to display additional informations
- ◆ <Ctrl>+<PageDown> to display the last screen of information
- ◆ <Ctrl>+<PageUp> to display the first screen of information

The following sections describe the statistics in the “Information for All Processors” window and each of the menu option windows.

## Information for All Processors

The “Information for All Processors” window contains general information about the SMP server.



To access the <F1> help screens for the “Information for All Processors” window, you must first press <Tab> to activate the window, then press <F1> to see the help screens. Press <Tab> again to return to the “Multiprocessor Options” menu.

### Information in the Window

The window includes the following information.

Statistic	Description
Total Processors	The number of processors detected by SMP, including processors that are installed but not enabled.
Active Processors	The number of enabled processors.

<b>Statistic</b>	<b>Description</b>
Combined Lock Assertions	The number of times that threads tried to acquire locks during the last update interval. Very high lock assertion values, such as values greater than 50,000, can indicate application problems.
Combined Lock Collisions	The number of times in the last update interval that locks were denied because requested resources were already locked. Sudden and unexpected increases can indicate application problems.
Maximum Lock Wait	The largest number of collisions for one lock during the last update interval.
Combined Utilization	The average utilization of all active processors. This is the same statistic as "Utilization" in the MONITOR main window.

## Significance of the Information

“Combined Lock Assertions”, “Combined Lock Collisions,” and “Maximum Lock Wait” values generally increase as “Combined Utilization” increases. Sudden and unexpected increases can indicate problems with an application. The application might not be well designed for a multiprocessing environment.

If sudden increases occur, refer to the “Mutex Information” window (described in “Mutex Information” on page 579) to determine which locks are causing high lock wait values or a high number of collisions. Then contact the application vendor or the application support service for assistance.

## Information by Processor

The “Processor Information” window displays information about individual processors. Processors that have not been enabled are not displayed on the screen.

Processor Information	
Processor:	0 ▲
Current state:	Running
Interrupts:	11
Utilization:	69%
Processor:	1
Current state:	Running
Interrupts:	4
Utilization:	0%
Processor:	2
Current state:	Running
Interrupts:	4
Utilization:	0%
Processor:	3 ▼
Current state:	Running

The window displays information for three processors. If your server contains more than three processors, use the arrow keys or press <PageDown> to see information for the additional processors.

## Information in the Window

The window contains the following information for each processor.

Statistic	Description
Processor	The processor number. Processor numbers start at 0.
Current state	The current state of the processor. States include <b>Running:</b> Enabled and working. <b>Idle</b> Enabled but not working. <b>Faulted:</b> Failed. <b>Dispatching:</b> A transitional state. The processor should be in this state only very briefly. <b>Assigned:</b> A transitional state. The processor should be in this state only very briefly.
Interrupts	The number of interrupts for the specified processor during the last update interval.
Utilization	The percentage of this processor's resources used during the last update interval.

## Significance of the Information

Use the processor statistics to monitor hardware performance and to determine whether processor 0 is overused.

The "Faulted" state means the processor has failed. Run a hardware diagnostic program or contact your hardware vendor.



“Dispatching” and “Assigned” are transitional states. The processor should be in these states only very briefly, probably not long enough for the state to be displayed on the screen.

If a processor does display one of these states continuously, there might be a hardware problem. Run a hardware diagnostic program or contact your hardware vendor.

Sudden large increases in the number of interrupts could indicate a processor problem, particularly if you notice declines in general system performance. Run a hardware diagnostic program or contact your hardware vendor.

If the utilization value is especially high for processor 0, you might want to use the SMP NetWare Kernel Mode SET parameter to give the native NetWare kernel priority on this processor or to exclude the SMP NetWare kernel from using this processor. See “Using SMP SET Parameters” on page 586.

If utilization is consistently over 50% and system performance is poor, you might need to add another processor.

## **Mutex Information**

The “Mutex Information” window displays information about specific mutexes both in NetWare SMP and in currently running applications. This screen can help you locate bottlenecks in the system.

Figure 8-1  
 “Mutex Information” Window

Mutex Name	Count	Fails	Wait	M Wait	Lock Type
LSL Alloc Node Mutex	0	0	0	0	Spin
LSL Multi-Send FWTD	0	0	0	0	Spin
LSL Multi-Send List	0	0	0	0	Spin
LSL Poll Mutex	0	0	0	0	Spin
LSL Rcv Event Mutex	0	0	0	0	Spin
LSL Service Events M	91	0	0	0	Spin
LSL Timer Mutex	16	0	0	0	Spin
marshalling table mu	0	0	0	0	Spin
mutex list mutex	0	0	0	0	Spin
nlm bound list mutex	0	0	0	0	Spin
Old AES List Mutex	0	0	0	0	Spin
process rundown list	0	0	0	0	Spin
processor_set queue	0	0	0	0	Sleep
processor_t delayed	0	0	0	0	Sleep
processor_t fast wtd	0	0	0	0	Sleep
processor_t hi-pri m	0	0	0	0	Sleep
processor_t hi-pri p	0	0	0	0	Sleep

For a brief description of mutexes, see “Mutual Exclusion Locks (Mutexes)” on page 572.

## Information in the Window

The window displays the following information for each mutex.

Statistic	Description
Mutex Name	<p>The name of the mutex. Some vendors name their mutexes so it is clear which application contains the mutex.</p> <p>In other cases, you must compare the mutex list before and after loading an application to determine which mutexes are associated with it. You can then determine whether any of the new mutexes display unusually high values for “Fails,” “Wait,” or “M Wait.”</p>
Count	The number of times that threads acquired this mutex during the last update interval.
Fails	The number of times that threads tried but failed to acquire this mutex during the last update interval.
Wait	The number of threads that waited for this mutex during the last update interval.
M Wait (Mutex Wait)	The largest number of times that one thread or processor tried but failed to acquire this mutex during the last update interval.
Lock Type	The type of mutex. Types include spin, sleep, and barrier.

## Significance of the Information

If a new application performs poorly and causes the lock statistics on the “Information for All Processors” window to increase dramatically, refer to the “Mutex Information” window to determine which mutexes are at fault. Use this information when you contact the application support service.

## Thread Information

The “Thread Information” window displays information about individual threads.

Figure 8-2  
 “Thread Information” Window

Thread Name	Processor	State	Utilization
▲ network kernel	0*	Running	44.48%
NTREND.NLM 1	0	Migrating	0.00%
NTREND.NLM 2	0	Migrating	0.00%
NTREND.NLM 3	0	Migrating	0.00%
NTREND.NLM 4	0	Migrating	0.00%
NTREND.NLM 5	0	Migrating	0.00%
NTREND.NLM 6	0	Migrating	0.00%
NWTRAP.NLM 1	0	Semaphore	0.00%
SNAP 0	0	Semaphore	0.00%
WKSTN 000181	0	Migrating	0.00%
worker thread	0	Running	55.79%
engine worker	1	Running	100.00%
engine worker	2	Running	100.00%
AUTO SRVR	3	Migrating	0.00%
AUTO WKSTN	3	Migrating	0.00%
engine worker	3	Running	100.00%
▼ INTERNAL IPC	3	Migrating	0.00%

You can change the order in which items are displayed on the window. See “Changing the Sort Order” on page 584.

### Information in the Window

Information about the following threads is displayed:

- ◆ NetWare kernel thread—represents all the threads currently being managed by the native NetWare kernel
- ◆ Worker thread—represents the idle loop for processor 0

- ◆ Engine worker threads—represent the idle loops for all the other processors
- ◆ All other threads managed by the SMP NetWare kernel

The window displays the following information for each thread.

Statistic	Description
Thread Name	The name of an active thread. Sometimes a number appears after the thread name. This number distinguishes threads with similar or identical names, such as NTREND.NLM 1 and NTREND.NLM 2.
Processor	The processor on which the thread was executed during the last update interval. The asterisk next to the processor number for the NetWare kernel thread means that the NetWare kernel thread is bound to processor 0. (The NetWare kernel thread can only be executed by processor 0.
State	The state of the thread.  The “Halted” state sometimes indicates a failed thread. The effect of a failed thread depends on the application. If the application fails and the thread state is “Halted,” contact your application support service.  Other states do not indicate problems.
Utilization	The percentage of the processor’s resources devoted to executing the thread. Percentages add up to approximately 100% for each processor.

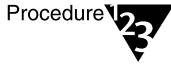
### Significance of the Information

You can use the “Thread Information” window to determine how much of processor 0’s resources are devoted to SMP threads. This information can help you decide whether to restrict SMP access to processor 0. See “Using SMP SET Parameters” on page 586.

## Changing the Sort Order

By default, information is sorted by thread name, but you can change the sort order as follows.

### Procedure



1. At the “Thread Information” window, press <F3>.

The “Sort By:” menu appears.

2. Choose one of the following sort orders:

- ◆ **Name**—sorts alphabetically by thread name. This is the default setting.
- ◆ **Processor**—sorts by processor number in ascending order. Items in the list will be reordered whenever SMP shifts a thread to a new processor.
- ◆ **State**—sorts alphabetically by the processor state.
- ◆ **Utilization**—sorts by the utilization percentage, in descending order.

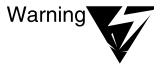
## Disabling and Enabling Processors

If your server supports dynamic interrupt distribution and recovery, you can enable and disable processors (except processor 0) while the server is running.

You might want to enable and disable processors if a processor is not working properly or if you want to compare system performance with different numbers of active processors.

If your server does *not* support dynamic interrupt distribution and recovery, you cannot disable a processor while the server is running. To take a faulty processor off-line, you would have to bring down the server and remove the processor.

Refer to your hardware documentation to determine whether your system supports dynamic interrupt distribution and recovery.



Warning

Disabling a processor shuts down your network if your server does not support dynamic interrupt distribution and recovery. Before attempting the following procedure, make sure your server does support dynamic interrupt distribution and recovery.

Before disable a processor, you must first unload all the processors (except processor 0) by unloading the MPDRIVER module, included with NetWare SMP.

You can then reload individual processors by reloading MPDRIVER for the processors that are to remain enabled.

### Procedure



Procedure

1. **To unload the MPDRIVER module, at the server console prompt type**

```
UNLOAD MPDRIVER <Enter>
```

This unloads all the processors except processor 0. You cannot unload processors individually.

2. **To reload those processors that are to be enabled, at the server console prompt type**

```
LOAD MPDRIVER processor_# | ALL <Enter>
```

For example, the following commands reload processors 1 and 3, leaving processor 2 disabled.

```
LOAD MPDRIVER 1 <Enter>
```

```
LOAD MPDRIVER 3 <Enter>
```

To reload all the processors, use the “ALL” parameter:

```
LOAD MPDRIVER ALL <Enter>
```

# Using SMP SET Parameters

SMP SET parameters allow you to control the SMP kernel's access to processor 0 and to make changes that might be required by your hardware or by specific applications.

To view current SMP parameter settings, enter the following at the console prompt:

```
SMP <Enter>
```

To change SET parameter values, use the SET command or the SERVMAN or MONITOR utility. See "SET," "SERVMAN," or "MONITOR" in *Utilities Reference*.

Table 8-1 describes the SMP SET parameters you can use to optimize system performance. The SMP SET parameters are found in the Miscellaneous category of NetWare SET parameters.

**Table 8-1**  
**SMP SET Parameters**

Parameter	Use to
SMP Stack Size = <i>number</i>	<p>Specify the minimum stack size for threads created by the SMP kernel APIs. Allocation requests for stacks smaller than this size will return the smallest value specified by this SET parameter.</p> <p>Do not change this parameter value unless an application package instructs you to specify a certain minimum stack size.</p> <p>A NetWare Loadable Module (NLM) program can specify stack sizes on a per-thread basis independent of this parameter.</p> <p><b>Minimum value:</b> 8192 <b>Maximum value:</b> 1048576 <b>Default:</b> 8192</p>



Table 8-1 *continued*

**SMP SET Parameters**

Parameter	Use to
SMP Polling Count = <i>number</i>	<p>Specify the maximum number of thread switches that will occur before NetWare runs symmetric polling procedures.</p> <p>Do not change this value unless an application package instructs you to do so.</p> <p>Polling procedures affected by this parameter include network board, disk adapter, and internal maintenance routines.</p> <p><b>Minimum value:</b> 70  <b>Maximum value:</b> 200  <b>Default:</b> 70</p>
SMP NetWare Kernel Mode = <i>value</i>	<p>Specify whether processor 0 is dedicated to native NetWare, shared by both the SMP and native NetWare kernels, or shared but with priority given to native NetWare.</p> <p><i>Dedicated</i> means native NetWare has exclusive access to processor 0.</p> <p><i>Shared</i> means native NetWare threads and SMP threads share processor 0, and SMP threads preempt native NetWare threads.</p> <p><i>Priority</i> means that native NetWare threads have priority while sharing processor 0. This setting is most useful when your system runs more than seven processors.</p> <p><b>Supported values:</b> Dedicated, Shared, Priority  <b>Default:</b> Shared</p>
SMP Flush Processor Cache = <i>value</i>	<p>Issue a WBINVD instruction that will cause the entire level 1 and level 2 processor caches to be flushed into core memory upon processor shutdown. This is often necessary in systems that do not maintain the cache controller in a warm state following processor shutdown.</p> <p>Do not change this value unless your hardware documentation instructs you to do so.</p> <p><b>Supported values:</b> ON, OFF  <b>Default:</b> OFF</p>

**Table 8-1** *continued*  
**SMP SET Parameters**

Parameter	Use to
SMP Intrusive Abend Mode = <i>value</i>	<p>Specify whether the server starts the SMP debugger when the server abends.</p> <p>When this parameter is set to ON, the server starts the SMP debugger whenever the system abends.</p> <p>When this parameter is set to OFF, the server does not start the debugger. Instead, it halts the offending thread and continues to run. However, if the system abends during an interrupt, the server starts the debugger even if the parameter is set to OFF.</p> <p>To exit the debugger, type <b>x</b> at the debugger prompt.</p> <p>For more information about the SMP debugger, see the <i>NetWare SMP Software Developer Kit</i>.</p> <p><b>Supported values:</b> ON, OFF  <b>Default:</b> ON</p>
SMP Developer Option = <i>value</i>	<p>Specify whether the server starts the SMP debugger both when the server abends and when the server memory protection detects a memory fault.</p> <p>When this parameter is set to ON, the server starts the SMP debugger both when the server abends and when the server memory protection detects a memory fault.</p> <p>When this parameter is set to OFF, the server does not start the debugger. Instead, it halts the offending thread and continues to run. However, if the server abends during an interrupt, the server starts the debugger even if the parameter is set to OFF.</p> <p>To exit the debugger, type <b>x</b> at the debugger prompt.</p> <p>For more information about the SMP debugger, see the <i>NetWare SMP Software Developer Kit</i>.</p> <p><b>Supported values:</b> ON, OFF  <b>Default:</b> OFF</p>

Table 8-1 *continued*

**SMP SET Parameters**

---

Parameter	Use to
SMP Memory Protection = <i>value</i>	<p data-bbox="419 301 705 323">Enable memory protection.</p> <p data-bbox="419 352 1223 467">When this parameter is set to ON, the server automatically handles page faults and general protection interrupts and tries to halt the thread causing the problem. The processor continues to operate. However, if the problem occurs during an interrupt, the server starts the SMP debugger.</p> <p data-bbox="419 493 1115 515">When this parameter is set to OFF, memory protection is disabled.</p> <p data-bbox="419 541 973 563">To exit the debugger, type <i>x</i> at the debugger prompt.</p> <p data-bbox="419 593 1163 648">For more information about the SMP debugger, see the <i>NetWare SMP Software Developer Kit</i>.</p> <p data-bbox="419 674 731 696"><b>Supported values:</b> ON, OFF</p> <p data-bbox="419 704 564 726"><b>Default:</b> OFF</p>

---



## ***Backing Up and Restoring Data***

The Storage Management Services™ (SMS™) architecture allows you to back up the Novell® Directory database, the file system, or an individual workstation's hard disk onto media that can be stored off-site. This gives you a periodic view (daily, weekly, monthly) of your data.

Then, in the case of hardware failure, natural catastrophe, corrupted data, or incorrectly deleted or changed data, you can return to a previous view of the data.

This chapter contains concepts and procedures to help you preserve and restore information. Concepts and procedures are grouped into the following sections:

- ◆ Understanding Storage Management Services (SMS), including information about the modules that make up SMS.
- ◆ Loading drivers, TSAs, and backup software, including procedures for loading the software needed to back up or restore information.
- ◆ Backing up data, including concepts and procedures for backing up the Novell Directory database and the file system.
- ◆ Restoring data, including concepts and procedures for restoring the Novell Directory database and the file system.
- ◆ Other SBACKUP tasks, including procedures for using log and error files.
- ◆ Administering storage devices, including procedures for checking the status of the device and media, renaming a device, and managing storage media.

- ◆ Enhancing backup performance, including procedures for managing compressed files and enhancing host server performance.
- ◆ Troubleshooting, including procedures and information for troubleshooting backup and restore problems.

## Understanding Storage Management Services (SMS)

Storage Management Services (SMS) is a collection of services that provide backup, restore, and data migration. These services are performed by a collection of components and are independent of operating systems and hardware.

The following SMS components are provided:

- ◆ Storage Management Engine (SME), for doing backup and restore operations. Novell provides the SBACKUP utility as a basic SME for NetWare®.

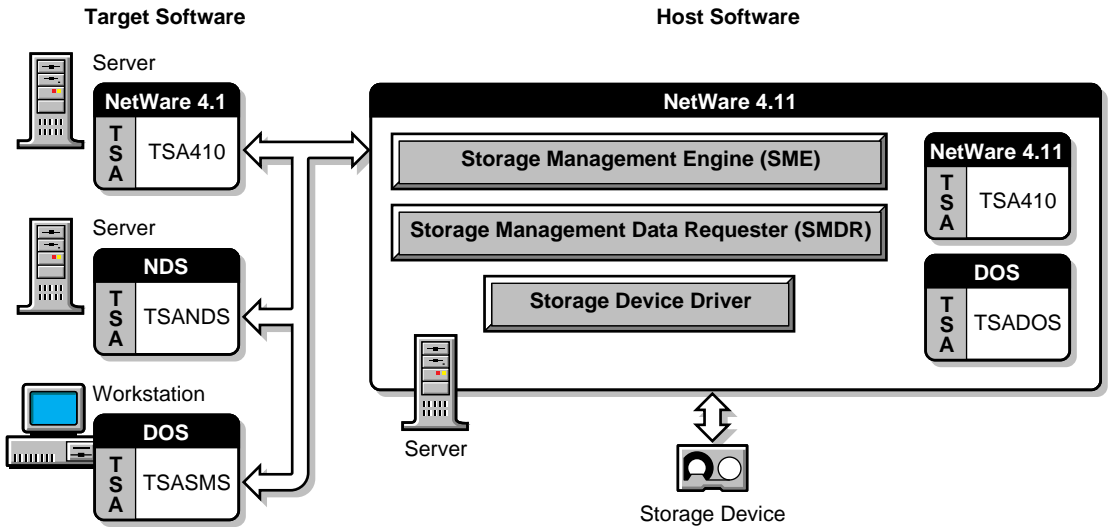
For more information about SBACKUP, see “SBACKUP” in *Utilities Reference*.

- ◆ SMDR (Storage Management Data Requester), for passing commands and information between the backup program and Target Service Agent (TSA) software.
- ◆ Storage device interface, for passing information between the Storage Management Engine and the storage devices.
- ◆ Device drivers, for controlling the behavior of the storage devices.
- ◆ Target Service Agents (TSAs), which pass requests and commands between the SME and server or NDS™ database, and prepare the data for the SME.

For more information about TSAs, see “Understanding Target Service Agents (TSAs)” on page 593.

- ◆ Workstation Manager, for identifying and keeping track of the stations waiting to be backed up.

**Figure 9-1**  
**Overview of SMS**



## Understanding Target Service Agents (TSAs)

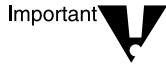
In SMS, a *target* is any item on the network that requires backup. Examples of targets include SQL database engines, NDS databases, workstations, and NetWare servers.

An SMS Target Service Agent (TSA) is a software module that knows how to scan, read, and write the target data. The primary functions of an SMS TSA are to prepare the target data for backup or restoration, and to communicate with the SME. For example, an SMS TSA for a NetWare server understands name spaces, file and directory attributes, security privileges, etc., for the data on that server.

The TSA packages data from the target and presents it to the SME in a generic format. This allows one SME to interact with many types of TSAs.

## Understanding Supported Storage Devices and Drivers

The NetWare 4.11 version of the SBACKUP utility supports 0.25-inch, 4mm, and 8mm storage devices. However, we recommend pretesting any tape drive device.



To ensure reliable operations, pretest all media storage devices that are not Novell certified with the appropriate NetWare device driver and SBACKUP backup/restore utility.

If you are using 4mm tape, use only DDS-certified, computer-grade tapes.

Use the driver files recommended by your hardware manufacturer.

## Understanding the Storage Management Engine (SME)

The Storage Management Engine (SME) is central to the SMS architecture. The SME communicates with the network clients to back up and restore information. Novell provides a basic SME (SBACKUP.NLM) with the NetWare operating system.

### Using SBACKUP

To optimize SBACKUP performance, you may want to consider the following:

- ◆ **Log in as ADMIN.** When connecting to a target (server, workstation, or database), log in as ADMIN, or as a network supervisor-equivalent for that target.

For security reasons, many SBACKUP options are limited to the network supervisor. You will have limited success backing up and restoring if you log in without supervisor rights.

- ◆ **Reserve disk space for temporary files.** Make sure you have disk space available (1 to 2 MB) on the target server's volume SYS: to accommodate temporary files.

SBACKUP creates temporary files on the target server during backup. If you have linked UNIX\* files or files with extended attributes, the temporary files might be larger than 1 MB.

- ◆ **Don't mount or dismount volumes during a backup/restore session.** The data might be corrupted or an abend might occur at the host server.



- ◆ **Use the correct name space and name space formats.** If you don't use the correct name space and name space formats when entering paths and file names, files can't be restored.

Name spaces: DOS, FTAM, Macintosh\*, NFS\*, and OS/2\*

Name space formats:

- ◆ For Macintosh, use *Volume::directory:directory:filename*
  - ◆ For all others, use *Volume:/directory/directory/filename*
- ◆ **Exit SBACKUP before unloading drivers.** If you unload a manually loaded driver (such as AHA1740.DSK or ASPITRAN.DSK) before exiting SBACKUP, you might cause the host server to abend.
  - ◆ **Use original case for non-DOS names.** Non-DOS pathnames and filenames are case-sensitive. NetWare recognizes DOS pathnames and filenames in uppercase, lowercase, or mixed case. If you're not sure of the original case, refer to your log file.

## Memory Requirements

To run SBACKUP, the host server requires a minimum of 3 MB of memory in addition to the memory required to run NetWare.

If the required 3 MB of memory is not available, you might be able to set the storage buffers lower than the default and still run SBACKUP.

For memory and buffer settings, see "Enhancing Host Server Performance" on page 677.

## Backup Files

Each backup session produces three types of files:

- ◆ **Data files**—Copied to the selected storage media.
- ◆ **Log file**—Placed in a directory on the host server and accessed through the SBACKUP “Main Menu” screen.
- ◆ **Error file**—Placed in a directory on the host server and accessed through the SBACKUP “Main Menu” screen.

Both log and error files contain pertinent information, such as the session’s date, time, and media identification, but the error file also contains a list of any errors that occurred during the backup session, such as files that were not backed up.

The log and error files are labeled with the same description you give the session.

## Backup Types

SBACKUP has four types of backup sessions:

- ◆ **Full backup**—Backs up the entire file system or Novell Directory database, regardless of whether the data has been changed since the last backup, and clears the modify bit after the backup.



If you have installed a migration system built on RTDM, such as Novell’s High Capacity Storage System (HCSS), you will have two full backup options: (1) “Full: All of the Target Including Migrated Data” and (2) “Full: All of the Target Except Migrated Data.”

If you choose to include migrated data, ensure your backup media capacity matches the jukebox media capacity. For more information on HCSS, see “Chapter 6, “Migrating Data Using the High Capacity Storage System,” on page 351.

- ◆ **Custom backup**—Backs up only the data you specify. Use this option when you want to select portions of the file system structure or NDS tree as the target, using include and exclude options.
- ◆ **Differential backup**—Available only for the file system; backs up only data that has been changed since the last full backup.

- ◆ **Incremental backup**—Available only for the file system; backs up only data that has been changed since the last full or incremental backup (whichever was last).

Differential and incremental backup are not interchangeable. See “Backup Schedules” on page 602 for examples of use.

## Custom Backup Options

A custom backup session allows you to

- ◆ Choose subsets of data to back up
- ◆ Scan what you are backing up

### Choosing Subsets of Data to Back Up

You can choose specific subsets of a data set to exclude from or include in the backup session by selecting major resources (such as volumes) or minor resources (such as directories, paths, or files) to exclude from or include in the backup.

### Understanding the Exclude and Include Options

Whenever you perform a custom backup, you can use the exclude and include options to select subsets of what you want to back up.

### Using Exclude

To back up most of the file system structure or Novell Directory tree structure while omitting only a small part, use the exclude option to omit the part you don’t want to back up. Everything that you don’t specifically exclude is included.

After you exclude part of the structure, like a volume, directory, or container, you cannot include any subdirectories, files, or objects beneath that excluded volume, directory, or container.

## Using Include

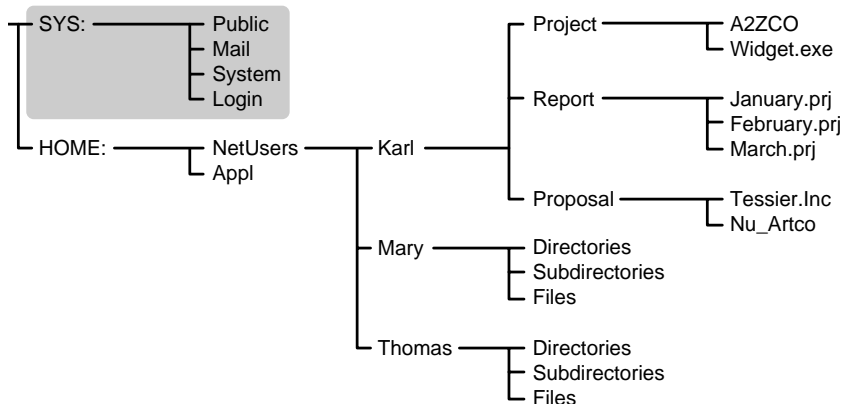
To back up a relatively small part of the file system structure, use the include option to specify the data you want. Everything you don't specifically include is excluded.

When you select only part of the file system structure to include (such as a volume), all directories, subdirectories, and files under that selection are included in the backup by default.

Figure 9-2 illustrates this use of the include option. In the figure, volume SYS: is selected as an include option. All other areas of the file system structure will be excluded from the backup.

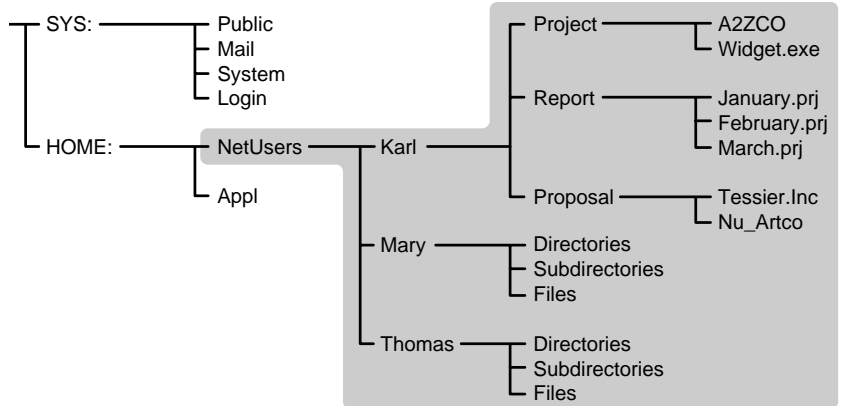
However, you can specifically exclude some subdirectories or files beneath your selection if you need to.

**Figure 9-2**  
**SBACKUP Include**  
**Option: Specific**  
**Volume Included,**  
**All Others Excluded**



The same principle applies when you specify a directory with the include option. Figure 9-3 shows that all directories, subdirectories, and files under the NetUsers directory will be included in the backup. All other areas of the file system structure are excluded from the backup.

**Figure 9-3**  
**SBACKUP Include**  
**Option: Specific**  
**Directory Included,**  
**All Others Excluded**



The reverse is true when you select a major Target Service Agent resource, a directory, or a file as an exclude option. All other areas of the file system structure will be included in the backup.

### Using Include and Exclude Options Together

By combining the include and exclude options, you can more precisely control what is backed up.

For example, the following command sequence results in volume HOME: being included in the backup, with the exception of the MARY directory and the WIDGET.EXE file.

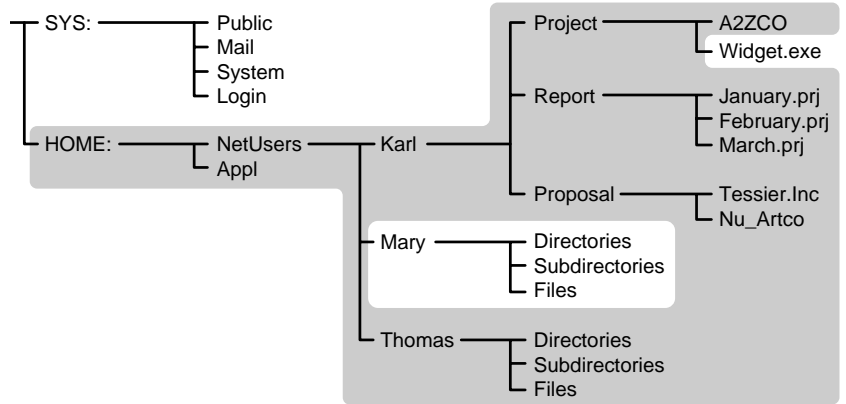
```

Include major TSA resources HOME:
Exclude directories (full path): HOME:NETUSERS/MARY
Exclude path/files HOME:NETUSERS/KARL/PROJECT/
WIDGET.EXE

```

Figure 9-4 illustrates this example.

**Figure 9-4**  
**Combining**  
**SBACKUP Include**  
**and Exclude**  
**Options**



### Scanning Data Sets

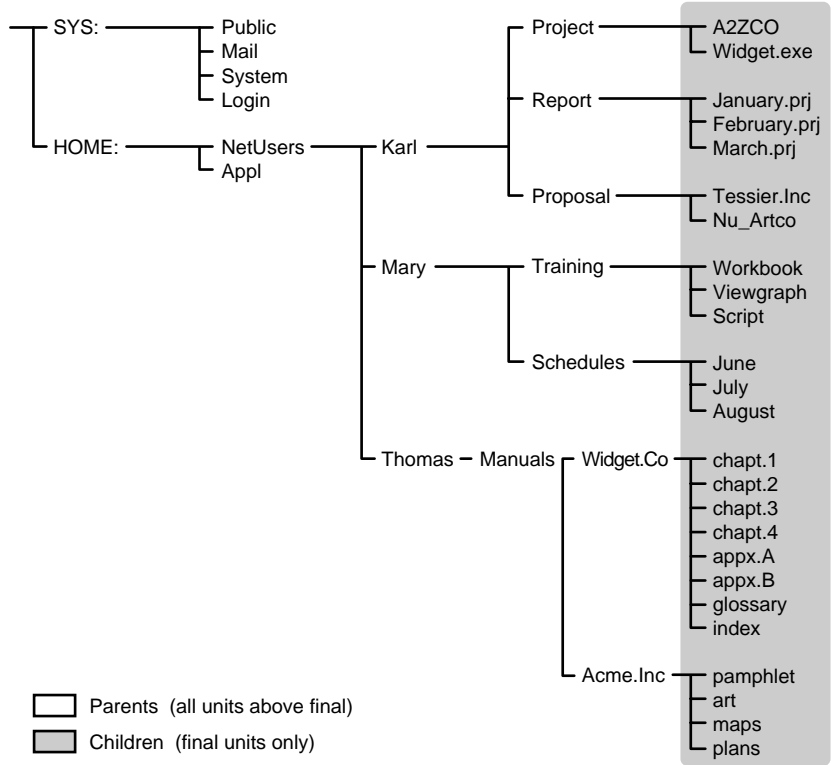
You can specify different types of data sets to be scanned.

A data set is a group of data that can be manipulated by SBACKUP. Each data set in the file system structure can be classified as a parent or a child, and each class includes different types of data items.

Within SBACKUP, a *parent* might be a server, a volume, or a directory. A *child* is a file, which is the lowest level of the directory structure.

As shown in Figure 9-5, the unit below a parent is not necessarily a child; it might be another parent, or the line might end with the parent. The unit above a child must always be a parent.

**Figure 9-5**  
**Parent and Child**  
**Levels in a File**  
**System Structure**



Items in a data set for either a parent or child should be items that do not frequently change. You may choose to exclude from the backup session one or more of the items in your target's data set.

## Backup Logbook

You should keep a hard-copy log of your backups in case your online log and error files become corrupted. The log should contain the following information:

- ◆ Source backed up (such as the server or workstation name)
- ◆ Full path for session log and error files directory
- ◆ Full path for backed-up data
- ◆ Label of the media on which the backup is stored

- ◆ Description of the session
- ◆ Name or initials of the person performing the backup
- ◆ Date and time of the backup session

## Backup Schedules

Before you begin actual backup procedures, plan a backup schedule based on your needs, considering such factors as the number of users and frequency of changes to files.

You may want to perform different types of backups on different schedules. For example,

- ◆ **Daily**—Perform an incremental or differential backup after the close of business. If revisions are heavy and rapid, consider several backup sessions each day.
- ◆ **Weekly**—Perform an incremental or differential backup after the close of business on the last day of the week for three of the four weeks in the month.
- ◆ **Monthly**—Perform a full backup on the last business day of the month (for example, the last Friday).
- ◆ **Major changes**—Perform a full backup before and after you change your configuration, and before and after you upgrade your server to a new version of the NetWare operating system.
- ◆ **Application changes**—Perform a custom backup before and after you modify applications.

## Effect of Backup Type and Schedule on the Backup and Restore Process

Each type of backup has a different effect on the backup and restore process. In planning your backup schedule, consider all of the variables before determining which schedule is right for you.

**Media usage and backup speed:** Each differential backup uses more media and is slower than an incremental backup, because it backs up more files. However, this helps increase the speed of the restore.



**Restoring after incremental backups:** If you have done full and incremental backups and need to restore data, you must restore the last full backup as well as all subsequent incremental backups.

**Restoring after differential backups:** If you have done full and differential backups and need to restore data after an unexpected loss, you need to restore only the last full and the last differential backup.

Incremental backup sessions back up only files that have the modify bit set, which are files that have changed since the last full or incremental backup session (when the modify bit was cleared).

When you perform a differential backup, the modify bit isn't cleared after the backup, as it is after a full or incremental backup. So, all files modified since the last full backup are included in the backup (unless they have been deleted).



Don't interchange differential backups and incremental backups. If you do, the differential backup won't contain all changes since the last full backup. Use full backups interspersed with differential backups, *or* full backups interspersed with incremental backups

## Understanding Backup for the Novell Directory Database

The best way to protect your Novell Directory database is to use replicas. For more information about replicas, see "Creating and Managing Directory Services Partitions" on page 296.

However, there are times when replication is not sufficient protection, as is the case with a single server network, or when all copies of the replicas are destroyed or corrupted. In these instances, if the NDS data has been backed up regularly, the Novell Directory tree can be restored using SMS.

You can back up the entire tree, or a selected section of the tree starting with a particular container. You can back up the schema and schema extensions.

You *cannot* back up partition information. If the tree gets corrupted and you restore the NDS data, all data will be restored into one partition, [Root]. You will then need to repartition that portion or the entire tree.

It is important that you keep a written copy of the tree structure and the partitions. You can use the DSMISC.LOG file that is backed up with the file system as part of the “server-specific information.”



Trustee assignments are backed up as part of the file system.

## **Distributed Database**

The network of servers that comprise a Directory tree continually exchange updates and other time-sensitive information. The Novell Directory database exists as a set of files that are stored on NetWare servers. The Novell Directory database files are stored on a server's volume SYS:, and are hidden so they aren't accidentally tampered with or deleted.

Although the Novell Directory database files are stored on a server's hard disk, they cannot be backed up like bindery files in previous NetWare versions.

## **Server Interdependence**

NDS is not server-centric, and neither are its backup and restore processes. Backing up NDS, for example, backs up data that is spread out over multiple servers. SMS Novell Directory database backups will gather all the necessary NDS data.

To handle all the necessary links and dependencies between objects, the backup/restore system must be able to navigate the entire Directory tree.

## **Object ID Numbers Are Backed Up Using Complete Names**

In NetWare 4™, a random ID number is assigned when an object is created. NetWare 4 uses object ID numbers to keep track of information such as users' trustee rights to directories and files in the file system.

These object ID numbers are stored in the Directory Entry Table (DET) of each file and directory, and are thus server-centric.

When NetWare 4 is backed up, SMS-compatible products store objects' complete names on the backup media, not the objects' ID numbers.

If an object with the same complete name as on the backup media already exists in the Directory tree, its object ID is not overwritten during a restore. If an object with the same name does not already exist in the tree, it is assigned a new object ID when restored. This occurs on every server where the object is used.

## Schema Backup

The schema is backed up automatically with a full NDS backup. You can also choose to back up the schema separately using a custom NDS backup.

## Placeholder (Unknown) Objects

Whenever insufficient information is known about an object, such as when one of its mandatory attributes is missing, NDS creates, as a placeholder, an object referred to as an *Unknown object*.



In NetWare Administrator, Unknown objects appear with a “?” icon.

During a restore session of the Novell Directory database information, Unknown objects are created when restoring an object that has an Access Control List, or any other attribute, that refers to other objects that do not currently exist in the tree.

This condition is common in a restore, since only one object can be restored at a time. When this condition arises, an Unknown object is created until the real object is restored.

For example, User object User1 has been given property and object rights to User object User2. If User1 and User2 are deleted and only User2 is restored, an object named User1 will be created but it will have a base class of Unknown.

This occurs because the Access Control List of User2 lists User1, which does not currently exist. The unknown object is used as a placeholder in the tree. If User1 is later restored, it will replace the unknown object.

If the restore session does not include the actual object for which the placeholder was created, the object will remain in the tree as type Unknown. You can expect to see unknown objects after a restore session if all network resources, such as servers, volumes, and users are not in place before the restore session has started.

Objects that remain unknown after a restoration is completed are those objects for which NDS couldn't resolve the dependencies. Either delete the Unknown objects and re-create the original object, or do a selective restore to overwrite the Unknown objects.

## Backup Software

In order to back up the Novell Directory database, the TSANDS.NLM software must be loaded on one server in the tree—preferably the server containing a replica of the largest partition.

For large or complex networks, you can improve performance by loading the TSANDS.NLM software on multiple servers around the network. This will minimize network traffic during the backup process and improve performance when the backup program must perform name resolution across the Directory tree.

The version of TSANDS.NLM that ships with NetWare 4.1x allows selective backup and restoration of a Directory tree.



Not all third-party backup applications support this selective backup and restoration. Check with the application vendor for details on product features.

In SBACKUP, you can begin the backup of the Novell Directory database from any container object in the Directory tree. The backup process will continue from that point downward to the end of that portion of the tree. If the selected container is the [Root] of the tree, the entire Directory tree will be processed.

This allows you to back up the entire tree or subsets such as a single branch, a single container, or even a single leaf object. Also, a scan option allows backup of only those objects for which the backup user has supervisory rights.



When you back up NDS, we recommend that you back up the entire NDS tree in a session whenever possible. Although partial NDS backups and restores are possible, there are numerous precautions and additional issues you must take into account. See "Restoring Information for Special Conditions" on page 656 for more information.

## Set Rights to Back Up Portions of the Novell Directory Tree

The network supervisor can assign backup administrators that have limited rights to the Novell Directory tree.

For example, suppose in your company you have three Organizational Units that need to be backed up (East, West, Mid). You could create three user objects—BackAdmin1, BackAdmin2, and BackAdmin3—and give them rights to the Organizational Unit that they are responsible to back up.

You would then create a TSANDS.CFG file that lists the complete name of the contexts where the backup administrators' rights begin. It would look similar to the following:

```
.OU=East.O=Acme  
.OU=West.O=Acme  
.OU=Mid.O=Acme
```

The backup administrators would only have rights to back up the Novell Directory tree beginning at the context listed, and the rights would continue until the tree stopped or the rights were filtered out.

The supervisor should assign Supervisor rights to the backup administrators for the section of the Novell Directory tree that they are responsible to back up.

The supervisor then needs to create a TSANDS.CFG file that lists the complete names of the containers where each of the back up administrators' rights begin.

The TSANDS.CFG file should be saved in the SYS:SYSTEM\TSA directory of the server doing the backup.

The backup administrators should use a custom NDS backup to back up the portions of the tree they have rights for.

## Frequency of Backup

In general, the Novell Directory database should be backed up on a weekly basis. The frequency of this backup depends on how often changes and updates are made to the Directory tree. For a tree that changes often, you may want to perform an NDS backup every time you do a full backup of all servers on the network. You should definitely back up NDS prior to major tree modifications.

To get a full backup, the entire Directory tree needs to be functioning, meaning that all partitions are synchronizing normally. A Directory tree cannot be backed up entirely if all replicas of any partition are offline.

## Understanding Backup for the File System

You can back up your volumes so that in the case of hardware failure, natural catastrophe, or accidental change or deletion of files, you will be able to restore the file system to a previous state and not lose the data completely.

To back up file system data, an appropriate SMS TSA must be loaded on each server for which a file system backup is to be created. For NetWare 4.11 servers, load TSA410.NLM.

Once the SMS TSA software is loaded, you can proceed to load the device drivers for your backup hardware and run the backup program of your choice.

To get a proper backup of file system information, make sure your backup application can handle the NetWare file system's name spaces, extended attributes, trustee rights, compression, etc.

## Trustee Assignments Are Stored in the File System

Trustee assignments are stored as part of the file system as an ID, and they are backed up by default when the file system is backed up with the SMS TSA software. If a User object is deleted and then re-created or restored, its object ID will not be the same as it was before.

This is why the SMS TSA410 module uses objects' complete names to back up the trustee rights from the file system. If a User object is deleted and re-created with a new ID, the user's trustee assignments in the file system can be restored.

As long as an object with the same name as on the backup media exists in the Directory tree when the file system is restored, the TSA can interact with NDS to rebuild the DET to reflect new object ID numbers.

For additional information about object ID and trustee issues, see “Beginning Procedures for Restoring NDS” on page 642.

### **Server-Specific Information Is Stored in the File System**

Server-specific information such as the replica information, ID information, name spaces loaded, and system configuration is stored on the server’s volume SYS:. This information is backed up as part of the file system as a single resource. This resource includes the following five files:

- ◆ **SERVDATA.NDS**— server-specific NDS data
- ◆ **DSMISC.LOG**—replica list and replica types on server at backup
- ◆ **STARTUP.NCF**—disk driver, name spaces, SET parameters
- ◆ **AUTOEXEC.NCF**—load modules, NetWare operating system configuration
- ◆ **VOLSINFO.TXT**—volumes on the server, name spaces loaded, compression, and migration information

You can also choose to back up this information individually. This information is not restored unless you specifically choose to restore it. It doesn’t *need* to be restored unless you have lost the server’s volume SYS:. Then you will need to replace the hardware and restore this information. For more information, see “Beginning Procedures for Restoring NDS” on page 642.

# Loading Drivers, TSAs, and Backup Software

This section describes how to load the software components to back up the server, the Novell Directory tree, or individual workstations.

## Loading Controller and Storage Device Drivers on the Server



Checklist

### Prerequisites

- Ensure that you have installed the storage device controller and storage device according to the hardware manufacturer's instructions.



Procedure

### Procedure

#### 1. Load the drivers for controller and storage devices.

To load device drivers, at the server console prompt, type:

```
LOAD [path]:controller_device_driver_name(s)  
<Enter>
```

```
LOAD [path]:storage_device_driver_name <Enter>
```

For example, to load the drivers from drive C:, type

```
LOAD C:SCSI154X.HAM port=234 <Enter>
```

```
LOAD C:SCSIHD.CDM <Enter>
```

```
LOAD C:SCSI2TP.CDM <Enter>
```

To have these device drivers load when the server starts, place these commands in the server's STARTUP.NCF file.

#### 2. To register the storage device with the system, type the following at the server console prompt:

```
SCAN FOR NEW DEVICES <Enter>
```



Note

If you load the drivers from within the STARTUP.NCF file, you do not need the "SCAN FOR NEW DEVICES" command.

## Loading TSAs

Table 9-1 contains a summary of the load commands for backup or restore targets.



Type the commands at the specified console in the order listed.

Table 9-1

**LOAD Commands for Servers, Workstations, or NDS Databases**

To back up or restore this	At this console	Enter this command
4.11 host server	4.11 host server	LOAD TSA410
4.11 target server	Target server	LOAD TSA410
4.1 target server	Target server	LOAD TSA410
3.12 target server	Target server	LOAD TSA312
3.11 target server	Target server	LOAD TSA311
Novell Directory database	Any 4.x server (preferably a server with a copy of the largest partition)	LOAD TSANDS
DOS workstation	Host server	LOAD TSADOS
	Target workstation	TSASMS [ <i>parameters</i> ] (see Table 9-2 on page 625)
OS/2, UNIX, Windows 95*, Macintosh workstations	Host server	LOAD TSAPROXY
	Target workstation	See the documentation that came with the workstation software.

To back up the Novell Directory database, you need to load TSANDS.NLM only once, on the server with a replica of the largest partition.

To back up the file system, you must load the respective TSA for the server (such as TSA410) on every server to be backed up.

To back up workstations, the appropriate TSA must be loaded on the workstation. For more information, see the documentation included with the client software.

To have the files load when the server starts, place the commands in the server's STARTUP.NCF file, and in the workstation's NET.CFG file or AUTOEXEC.BAT file (for DOS) or Startup folder (for OS/2).

# Loading SBACKUP on the Server



## Prerequisites

- Ensure that you have met the prerequisites detailed in “Loading Controller and Storage Device Drivers on the Server” on page 610.
- Load necessary drivers and TSAs.



## Procedure

1. **Load SBACKUP at the server console using the following format:**

```
LOAD [path]SBACKUP [SIZE=number] [BUFFER=number]  
<Enter>
```

Option	Supported Values
Size	16, 32, 64, 128, or 256 KB (Default: 64 KB)
Buffers	2 to 10 (Default: 4)

For information on changing buffer sizes and numbers, see “Enhancing SBACKUP Performance” on page 676.

# Backing Up Data

Use SMS to create a tape backup of the Novell Directory database, or of the file system on the servers or workstations. The procedure listed here uses SBACKUP as the Storage Management Engine.

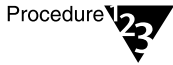
## Prerequisites



- Understand the rules and guidelines for using SBACKUP. (See “Using SBACKUP” on page 594.)
- Ensure that you know the workstation password if you are backing up a workstation. For DOS workstations, make sure the Target Service Agent was loaded with the /Password parameter instead of the /Trust parameter, as explained in Table 9-2 on page 625.
- If you are backing up the Novell Directory database, ensure that NDS synchronization and communication is functioning properly.
  - ◆ Before starting the backup, make sure NDS is fully functional. This means that all partitions are synchronizing correctly. For more information, see “Determining Replica Synchronization Status” on page 257.
  - ◆ If your backup host and targets communicate across a WAN, check the status of the WAN links to verify that they are operating properly.
- If you are backing up the file system, make sure you have Read and File Scan rights to the directories/files you are backing up.
- Ensure that you know what type of backup you want to perform: full, differential, incremental, or custom. (See “Backup Types” on page 596.)
- For a custom backup, ensure that you know the file system structure of the target you are backing up. You will be prompted for the paths to the volumes and directories that you want to include in or exclude from your backup.
- Ensure that you have loaded the drivers for your specific device and controller board.
- Ensure that the required files for your target are loaded. (See Table 9-1 on page 611.)

- Ensure that you have loaded the SBACKUP files for your specific target. (See “Loading SBACKUP on the Server” on page 612.)
- Ensure that media is inserted into your storage device.

**Procedure**



- 1. From the SBACKUP “Main Menu,” choose “Backup.”**
- 2. Choose a NetWare server running your backup/restore Target Service Agent.**

If you don’t see the target you want on the list, check for these possible causes:

- ◆ The proper Target Service Agent isn’t loaded on either the host or the target. (See Table 9-1 on page 611 for LOAD commands.)
- ◆ The host and target are physically far apart, or network traffic is heavy. Press <Esc> to return to the “Main Menu,” and then press <Enter> again. Your target should now be listed. From the “Target Services” list, choose a target.

If you are backing up	Then
The file system	Choose the server whose file system you want to back up.
The Novell Directory database	Choose the server with TSANDS loaded.
A workstation	Choose the workstation’s host server, and then select the workstation.
Server-specific information	Choose the server whose server-specific information you want to back up, and then choose to back up the file system.

**3. When prompted for the target username, enter the username (and context if required) for the target.**

If SBACKUP rejects the username you entered, you probably need to include the context of where the user object is located. For example, instead of entering “ADMIN” as the username, enter “.CN=ADMIN.O=*company\_name*”.

You must include the context in the username at this point if the username you use exists in a Directory container that is different from the context set on the server running SBACKUP.

**4. If a password is requested, enter the password for the target.**

SBACKUP will take a few moments to attach to the target. Wait for the confirmation box, then press any key to continue.

**5. Select the device and media for the backup.**

- ◆ If your host has only one storage device attached, SBACKUP selects the device for you and notifies you of the device and media that will be used.
- ◆ If your device has more than one storage device attached, choose an available device from those listed.
- ◆ If the device contains media, SBACKUP automatically selects it for the backup.
- ◆ If the storage media does not have a label, SBACKUP displays a message saying that the media cannot be identified. SBACKUP continues, but prompts you later to enter the media label.

**6. Specify a location for your session log and error files.**

To specify a location, use one or more of the following methods.

- ◆ Press <Enter> to accept the default location.
- ◆ Press <Insert> to choose from a list of network directories; choose a directory, and then press <Esc> to return to the previous window.
- ◆ Backspace over the path shown (or a portion of the path), then either type in a new directory or path or press <Insert> to choose from a list.

## 7. From the “Type of Backup” menu, choose the backup type.

If you are performing a	Go to
“Full,” “Differential,” or “Incremental” backup	Step 8
“Custom” file system or workstation backup	“Custom File System or Workstation Backup” on page 621
“Custom” NDS backup	“Custom NDS Backup” on page 620
Server-specific information backup	“Custom File System or Workstation Backup” on page 621



For more information on the types of backup, see “Backup Types” on page 596.

## 8. At the “Backup Options” screen, complete the form.

### 8a. Type a description for the backup session.

The description should help you identify the specific backup session so that, if a restore is necessary, you can easily identify the session you need.

SBACKUP automatically adds the date and time, the number of the media in the media set series, and the source (such as the NetWare server or workstation name, but not the volumes, directories, etc.) of the data backed up.



There are no special requirements for what to enter as the session description. You may want to include the full path of the data (for example, SYS:HOME\REPORTS\APRIL.96) which you will need to know if a restore session is necessary.

**8b. (Optional) If your form has an “Append to Previous Sessions on Media” option, specify whether or not to append.**

The option will appear on your “Backup Options” form only if your device supports appending to previous sessions on the media, and the media already has one or more sessions on it.

Accept the default “No” if you want to label new media, or to change the media label and overwrite all sessions on the media. The media rewinds and existing data is overwritten by the next backup.

If you want to append this session, type “Y” and press <Enter>. The backup session is appended to the media at the end of the previous session. Each appended session has separate backup and error logs.



If you are appending a backup session to a media set (two or more tapes), insert the last tape in the set.



Labeled media is not considered empty media. There don't need to be any sessions on the media for you to be able to set the “Append” option to “Yes.”

Delete the log and error files for any session you overwrite, to avoid trying to restore a session that no longer exists.

**8c. (Optional) Choose to verify that the data was correctly backed up.**

Accept the default “Compute Verification Values” if you want to be able to check later that the data was backed up correctly and that the data is still good and able to be restored.

If you want to verify the data immediately after the backup and be able to verify later also, choose “Compute Values and Run Verification.”

If you don't want to check the data now or later, choose “No.”

**9. Press <F10> to save your options and continue with the backup.**

**10. Choose when you want the backup to start, and then go to the step indicated below.**

If you chose	Go to
"No, Return to the Options Form"	Step 8, or continue to exit by pressing <Esc>
"Start the Backup Now"	Step 13
"Start the Backup Later"	Step 11

**11. In the "Start the Backup At" screen, set the date and time for the backup to begin.**

You can choose the default date and time shown for the backup to begin, or you can type a new date and time. The default is midnight of the current day.

Press <F1> for help with the format for entering a date and time for the delayed backup.

**12. Press <F10>, and then press <Enter> to save your changes.**



To help safeguard your network, SBACKUP disconnects from the target when a delayed backup is complete. If the delayed backup session cannot fit on the media, SBACKUP prompts you to insert additional media.

If additional media is not inserted, the backup does not finish and SBACKUP does not exit, thus compromising security.

**13. (Optional) If you set the "Append to Previous Sessions on Media" option to "No" in Step 8b on page 617, after the media is mounted, enter the media label.**



If you set this option to "No" (in Step 8b), the data in the current session and the new label you are prompted to enter will overwrite the existing data and label. All previous sessions contained on the media will be lost.



Note the media label on the media cartridge so that you can find it easily when SBACKUP asks for it during a restore session.



If the media does not have enough empty space to hold the entire backup session, SBACKUP prompts you to insert additional media when the current media is full. SBACKUP breaks the session after completing a file and “spans” the next file to the next media. SBACKUP then copies the media label from the previous media and increments the media number.

**14. (Optional) To abort a backup any time during the session, press <Esc> and choose “Yes” from the “Abort Menu.”**

SBACKUP finishes backing up the current data set and then displays a “Dismounting Media” message. Dismounting will take a few minutes.

When the media has been dismounted, the “Backup Terminated” message is displayed. Press <Enter> to return to the “Type of Backup” menu.



When you abort a backup session, SBACKUP finishes backing up any files in progress at the time of the abort.

**15. Verify that the backup was successful.**

When the backup has finished, your screen display should say:

```
The backup process was completed normally.
```



If you have performed a delayed backup, you will not see this screen. For security reasons, SBACKUP exits to the “Main Menu” after a delayed backup.

If an error message is displayed, check the error file for more specific information about the backup session.

**16. To return to the “Main Menu,” press <Enter> and then <Esc>.**

The <Esc> key allows you to exit SBACKUP one screen at a time until you reach the “Main Menu.” If you want to exit SBACKUP, press <Esc> once again and answer the confirmation prompt.

## Procedures for Custom Backups

A custom backup allows you to specify exactly what you want to back up, such as a server, volume, Novell Directory database, workstation, directory, or file. You can even specify subsets of groups.

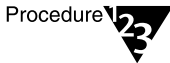
SBACKUP displays prompts and messages at the bottom of the screen. For example, you can press <F1> for help at any time.



If you are performing a series of backups or restores and need to change your target, follow the procedures in “Changing Targets” on page 675 before proceeding.

### Custom NDS Backup

#### Procedure



1. From the “Type of Backup” menu, select “Custom: Only Specified Data.”
2. At the “Custom Backup Options” screen, complete the form.



At least two levels of help screens are available to you in the “Custom Backup Options” screen. To see help for a specific line item, select the item and press <Enter> to get into editing mode, and then press <F1>.

If you want to allow backup administrators to be able to back up only certain sections of the Novell Directory tree, see “Set Rights to Back Up Portions of the Novell Directory Tree” on page 607.

#### 2a. Select “What You Want to Back Up.”

If you want to start the backup at a container other than [Root], press <Insert>. You will be able to browse the Novell Directory tree, and choose the container where you want the backup to begin.

Backup administrators should choose the “What Do You Want to Back Up” option, and press <Insert> when the “What to Back Up” screen appears.

The contexts set in the TSANDS.CFG will be listed. The backup administrators should choose the contexts were they have rights.



Do not use the following characters in the “What You Want To Back Up” field: a question mark (?), an asterisk (\*), or a drive letter with wildcard characters (C:\*). SBACKUP accepts them but does not back up anything.

**2b. (Optional) Choose subsets of what you are backing up.**

The “Default” setting means that everything in the “What You Want to Back Up” screen is backed up—nothing specific has been included or excluded.

If you want to include or exclude container or leaf objects, you can select those by including the complete name of the object.

**2c. (Optional) Specify how SBACKUP should scan the data to be backed up.**

To see the list of data set items available to scan, press <Enter>. You can choose to exclude objects below the current container, or objects the user has no rights to back up.

The default “No” means that nothing will be excluded. If you want to accept the default, press <Esc>.

The backup admin should type “Y” on the “Exclude Objects for Which the User Has No Rights” option.

For information about how SBACKUP scans data, see “Data set” in *Concepts*.

When all data items are set as you want them to be, press <Esc> or <F10>.

**2d. Return to Step 8a of “Backing Up Data.”**

## Custom File System or Workstation Backup

### Procedure



- 1. From the “Type of Backup” menu, select “Custom: Only Specified Data.”**
- 2. At the “Custom Backup Options” screen, complete the form.**



At least two levels of help screens are available to you in the “Custom Backup Options” screen. To see help for a specific line item, select the item and press <Enter> to get into editing mode, and then press <F1>.

**2a. Specify what you want to back up**

If you want to see a selection list, press <Insert>. If you are backing up the server, you can choose to back up the NetWare server, the server-specific information, or volume SYS:. You can browse the file system structure of volume SYS: to select where the backup should begin.

The “NetWare Server” option backs up the entire server except for the Novell Directory database. If you want to back up the Novell Directory database, you must change your target to “NetWare 4.0 Directory.”

If you are backing up a workstation, “DOS Workstation” or “OS/2 Workstation” will be the default option if either of these is your target. Each one backs up the entire workstation. You can also choose drive C: and browse to select a directory where the backup should begin.



Do not use the following characters in the “What You Want To Back Up” field: a question mark (?), an asterisk (\*), or a drive letter with wildcard characters (C:\*). SBACKUP accepts them but does not back up anything.

**2b. (Optional) Choose subsets of what you are backing up.**

At the “Custom Backup Options” screen, choose “Subsets of What You Are Backing Up” to see a list of available subsets of the file system structure. You can choose to include or exclude specific files or directories from the backup.

The “Default” setting means that everything in the “What to Back Up” screen is backed up—nothing specific has been included or excluded.

**2c. (Optional) Specify how SBACKUP should scan the data to be backed up.**

Press <Enter>. The list of data set items available to scan is displayed.

You can exclude user account information or types of files and directories (such as hidden or system files).

The default “No” means that nothing will be excluded. If you want to accept the default, press <Esc>.

If	Then
You have installed a migration system built on RTDM, such as Novell's High Capacity Storage System (HCSS)	Choose to exclude the migrated file data in the "How To Scan What You Are Backing Up" field.
You want to exclude a particular type of data from the backup	Move the cursor to the appropriate line, press <Enter> to access an edit mode (blinking cursor), and type "Y." Press <Enter> to save the settings. (The "No" is replaced with "Yes.")
You have compressed files or a compressed volume that you might want to restore to a noncompressed volume	Choose the "Backup Compressed Files as Expanded Files" option.

For information about how SBACKUP scans data, see "Data set" in *Concepts*.

When all data items are set as you want them to be, press <Esc> or <F10>.

**2d. Type a description for the backup session.**

A session description helps you locate a session when you restore data. This description becomes the header for log and error files.

**2e. Specify whether to clear the modify bit on the selected data after the backup.**



If you clear the modify bit, these files will not be recognized as having been changed at the time of the next backup, unless they are changed again between this backup and the next one.

The default is "No," meaning that the modify bit is not changed after files are backed up. Files are backed up in the next backup session even if they were not modified.

If you want to reset the modify bit, type "Y" and press <Enter>. The modify bit will be cleared after the files are backed up.

**2f. Return to Step 8b of "Backing Up Data."**

# Loading Software for Backing Up Workstations

## Prerequisites



Checklist

- Ensure that you have met the prerequisites detailed in “Prerequisites” on page 613.

## Procedure



Procedure

- 1. At the host server, load either TSADOS or TSAPROXY, depending on your target workstation.**

For more information, see Table 9-1 on page 611.

- 2. At the target workstation, change to the client software directory where the TSA (TSASMS.COM, TSAOS2, etc.) resides.**

For more information, see the documentation that came with the workstation software.

- 3. At the same workstation, enter the load command for your Target Service Agent.**

To load TSASMS for a DOS workstation, use the following syntax and Table 9-2.

```
TSASMS /SE=server_name /P=password /T /  
D=drive_letter /N=workstation_name
```

Table 9-2 explains how to use the TSASMS parameters at DOS workstations.

**Table 9-2**  
**TSASMS Parameters**

Parameter	Rules for Use	Explanation
<code>/SE[river]= server_name</code>	Must specify the host server.	Specifies the name of the NetWare server that you want the target workstation to connect to for backup and restore services.
<code>/P[assword]= password</code>	Required if <code>/T[rust]</code> parameter is not used. Limited to 10 characters.	Identifies the target workstation's unique password, or is used initially to specify a password.
<code>/T[rust]</code>	Required if <code>/P[assword]=password</code> parameter is not used. Use only if bindery services are used on host server. User must be ADMIN or a supervisor equivalent.	Allows a supervisor equivalent to back up and restore without the workstation password if bindery services are used on the server (if "Set bindery services" is in the AUTOEXEC.NCF or on the server console).
<code>/D[rive]=drive_letter(s)</code>	Must specify at least one (C, D, or E). If two or more, do not space between letters (example: /D=CD).	Specifies the hard disk(s) being backed up or restored. TSASMS will not back up diskette drives or network drives.
<code>/B[uffers]=number</code>	Not required, but can be changed ( <i>number</i> = 1 through 30).	Increases the number of buffers, which increases throughput speed but requires more RAM on the workstation. Default: one buffer.
<code>/N[ame]= workstation_name</code>	Required the first time TSASMS is loaded for a particular server. Limited to 10 characters.	Identifies the target workstation's unique name, or is used initially to name a workstation.
<code>/ST[ack]=number</code>	Not required. Use only if RAM is extremely limited or you receive "Stack Overflow" messages. Replace <i>number</i> with a number (512 through 4096).	Specifies stack size. Default: 2048 bytes.
<code>/U[nload]</code>	Can be used only at the workstation command line.	Unloads TSASMS from the workstation's memory.
<code>/H[elp]</code>	Can be used only at the workstation command line.	Displays all parameters.

For example, to load TSASMS where the following is true for the workstation being backed up,

- (1) CHICAGO is the host server name
- (2) The /T[rust] parameter is used
- (3) Drive C is specified as the target drive
- (4) BASEBALL is the workstation name

at the workstation command line, type

```
TSASMS /SE=CHICAGO /T /D=C /N=BASEBALL <Enter>
```

If loading multiple terminate-and-stay-resident (TSR) programs on a DOS workstation, load TSASMS last.

To avoid loading the workstation Target Service Agent with each session, place it in the workstation's AUTOEXEC.BAT file or NET.CFG file (for DOS) or Startup folder (for OS/2).

If you decide to use NET.CFG, be aware that

- (1) You must be using IPXODI and LSL.
- (2) Command line parameters override the NET.CFG file.
- (3) /H and /U are only available at the command line.

For more information on the NET.CFG file, see *NetWare Client for DOS and Windows User Guide*.

#### 4. At the host server, load SBACKUP using the following syntax:

```
LOAD SBACKUP [options]
```



For information on SBACKUP options, see "Loading SBACKUP on the Server" on page 612.

To avoid loading the commands with each session, place them in either the server's AUTOEXEC.NCF or STARTUP.NCF file.



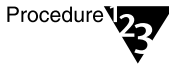
## Loading SMS Software for Backing Up SFT III Servers

The NetWare 4.11 SFT III™ operating system handles device input/output and file system operations in separate engines, the IOEngine and the MEngine. Enter load commands in the engine indicated.



For NetWare SFT III 3.11, TSA311 loads at the MEngine prompt, and SBACKUP loads in the IOEngine associated with the tape device.

### Procedure



1. **Change to the IOEngine prompt of the SFT III server where the storage device is installed.**
2. **Load the device drivers for the controller and storage device. (See “Loading Controller and Storage Device Drivers on the Server” on page 610.)**

For example, type

```
LOAD AHA1740 <Enter>
LOAD TAPEDAI <Enter>
```

To have the drivers load automatically, put the LOAD commands in the IOSTART.NCF file of the server with the storage device.

3. **Change to the MEngine prompt.**
4. **Enter the load commands for your target. (See “Loading TSAs” on page 610.)**

For example, type

```
SCAN FOR NEW DEVICES <Enter>
LOAD TSA410 <Enter>
LOAD SBACKUP <Enter>
```

To have the modules load automatically, put the commands in the MSAUTO.NCF file.

## Understanding Restoring Using SMS

If regular backups have been performed, then in the event of hardware failure, natural disaster, or corrupted or deleted data, the data can be restored.

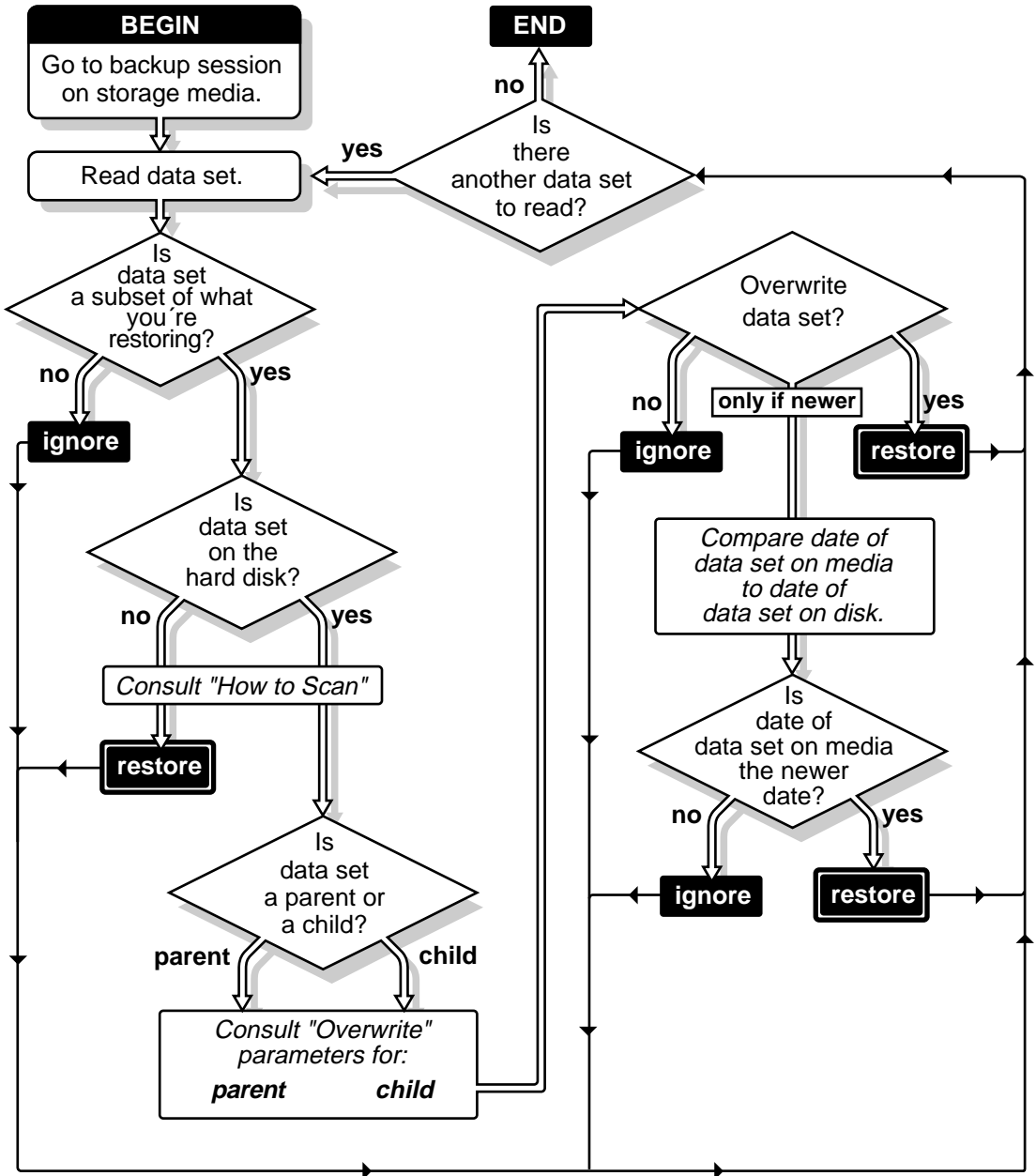
## How SMS Restores Data

During a restore session, SMS reads the backup storage media and the Target Service Agent compares the media data set to the existing hard disk data set. The Target Service Agent evaluates each data set according to the following criteria:

- ◆ Is this data set a subset of what is being restored?
- ◆ Is this data set found on the hard disk?
- ◆ Which parts of the data set are subject to restoring?
- ◆ Is this data set a parent or a child, and is the “Overwrite” parameter set to “Yes,” “No,” or “Overwrite Only if Newer?”
- ◆ If the parameters for a child are set to “Overwrite Only if Newer,” does the backup copy have a more recent date than the existing copy?

Figure 9-6 shows how SMS evaluates data sets before restoring data.

Figure 9-6  
How SBACKUP Restores Data



## Understanding Restore Issues with Novell Directory Services

The only absolute way to ensure that your Novell Directory database can be fully restored is through partition replication, with replicas of the entire database on multiple servers. For more information on replicas and partitions, and on creating partitions, see “Creating and Managing Directory Services Partitions” on page 296.

On a single-server network, you need to rely more heavily on backing up the data, because you don’t have the replicas to restore information.

If part of the tree, including partitions and replicas, exist when the Novell Directory database information is restored, those partitions and replicas will be fully utilized and you won’t need to repartition the tree.

If data has become corrupted, you should

1. Delete the corrupted NDS data.
2. Allow time for the deletion to propagate throughout the network.
3. Restore the NDS data.

A replica containing the object does not have to be on the server. NDS creates external references as necessary.



An external reference is a pointer to an NDS object not found locally on the server; it is used to authenticate and reference objects that are not local to the server.

There are specific recovery procedures for the following scenarios:

- ◆ Loss of a non-SYS: volume
- ◆ Loss of volume SYS: or an entire server
- ◆ Loss of the entire Directory tree

### Loss of a Non-SYS: Volume

Loss of a non-SYS: volume doesn’t affect NDS. All that is required is to restore the file system data and trustee rights.

## Loss of Volume SYS: or an Entire Server

A hard disk failure involving volume SYS: affects the entire server and halts all NetWare operating system activities. Because the NDS files are stored on volume SYS:, losing volume SYS: is equivalent to removing NetWare 4 and NDS from the file server. You must reinstall NetWare 4 and NDS before you restore your data.

The procedures for this scenario are divided into two cases:

- ◆ Loss of the only server in a single-server network
- ◆ Loss of a single server in a multiple-server network

### Single-Server Network

In a single-server network, failure of that server will bring all network operations to a halt. The same situation exists if the failure affects only the hard disk(s) containing volume SYS:.

Since there are no replicas in a single-server network, you can't recover any NDS information from a replica.

Use the following steps as an outline of steps to follow to restore the server.

1. Repair or replace the failed hardware.
2. Reinstall NetWare.
3. Restore NDS from an SMS backup. (For more information, see "Restoring Data" on page 635.)
4. Restore the file system. (For more information, see "Restoring Data" on page 635.)

### Multiple-Server Network

In a multiple-server environment, it is possible for one server to go down but for the rest of the servers in its replica list to remain intact.

The same situation exists if the hard disk(s) containing volume SYS: on one server becomes damaged, causing the failure of the entire server.

Use the following steps as an outline of steps to follow to restore the server.

1. Repair or replace the failed hardware.
2. Restore SERVDATA.NDS (the server-specific NDS information) for the failed server to another server on the network.
3. Reinstall NetWare, including restoring the SERVDATA.NDS file to the original server.
4. Restore NDS from an SMS backup. (For more information, see “Restoring Data” on page 635.)
5. Restore the file system. (For more information, see “Restoring Data” on page 635.)
6. Restore any replicas that were removed from the server.

### **Loss of the Entire Novell Directory Tree**

If all servers on a network are destroyed because of a disaster, you must perform a complete restoration of NetWare 4, NDS, and file system data.

This process will go much more smoothly if you have documented your Directory tree and the location of Server objects, partitions, and replicas.

It is also a good idea to record bindery context settings and other relevant information.

Use the following steps as an outline of steps to follow to restore the Novell Directory tree.

1. Repair or replace the failed hardware.
2. Reinstall NetWare on the first server.
3. Install NetWare on remaining servers to create a skeleton of the tree.
4. Restore NDS to a server from an SMS backup. (For more information, see “Restoring Data” on page 635.)

5. Restore the file system to all servers. (For more information, see “Restoring Data” on page 635.)
6. Reestablish partition boundaries and distribute replicas.

## Restore Sessions

Use SBACKUP to retrieve and reinstate data you have backed up to a storage media. Typically, you would restore data if it has been lost or corrupted since the backup was made.

A restore session restores data from a backup. The restore session produces the requested data, which is retrieved from the storage media and restored to the location you specify. If an error occurs during the restore session, an error message is appended to the error file on the host server.

The error file is labeled with the same description that you give the backup session (such as “Friday’s Full Backup”) and is accessed through the “Log/Error File Administration” option of the SBACKUP “Main Menu.”

The error file might be located in the default directory or in another directory that you specified during the backup or restore session.

## Restore Options

For a custom restore session, you can specify exactly which data to restore. Several options work together to allow you maximum flexibility in your restore session. These options allow you to do the following:

- ◆ Choose subsets of data to restore
- ◆ Scan what you are restoring
- ◆ Overwrite an existing parent (such as a container) or child (such as an object)

## **Choosing Subsets of Data to Restore**

You can choose specific subsets of a backup session to include in or exclude from the restore session by selecting major resources (such as volumes, server-specific info, or containers) or minor resources (such as directories, paths, files, or objects).

For more information about including and excluding, see “Custom Backup Options” on page 597.

## **Overwriting Existing Parents or Children**

You need to be careful when you are doing a selective restore, and choosing whether or not to overwrite existing parents or children, especially NDS objects. Objects such as groups and users have references to other objects in the Directory tree that will be affected by a selective restore.

For example, suppose a part of the Novell Directory tree becomes corrupted and several users are deleted from the tree. There is a group that contains those users, but once the users are gone, the group purges the membership list to remove those users; however, the group continues to exist in the tree.

Now, if you do a selective restore and choose not to overwrite existing objects, the group membership list will remain empty even if you restore the users. You will need to manually add the users to the group membership list, or to restore the original group.



# Restoring Data

Use SMS to restore information from tape backup. The procedure listed here uses SBACKUP as the Storage Management Engine.

## Prerequisites



- Ensure that you know the username and password for the target server or workstation to which you want to restore data.
- Ensure that you know the session description that you want to restore. You can get this information from your session log and error files. (See “Log and Error Files” on page 659.)
- For a custom restore session, ensure that you know the file system structure of the data you are restoring. You will be prompted for specific paths and filenames while setting the restore options.

If you restore the server-specific information from the file system backup of the failed server to a functioning server or location, you can use the VOLSINFO.TXT file as a reference for this information.

- If you want to restore data to a new location (different from where the original data was located), you must specify the full path to both the original data and the new location. If the new location does not exist, SBACKUP will create a new file system structure.



You can get the original path from your backup logbook or from the session log files, if you noted the path at the time the backup was performed.

- Ensure that media is inserted into your storage device.
- Replace faulty hardware or correct the problems that caused data loss.

## Procedure

### 1. Choose what you are restoring.

Use the table below to help you.

If you are restoring	Then
A non-SYS: volume	Go to “Begin to Restore a Non-SYS: Volume” on page 642.
Volume SYS: in a single server network	Go to “Begin to Restore a SYS: Volume in a Single-Server Network” on page 643.
Volume SYS: in a multiple-server network	Go to “Begin to Restore Volume SYS: in a Multiple-Server Network” on page 643.
The entire Novell Directory tree	Go to “Begin to Restore the Entire NDS Tree” on page 646.
NDS on a server	<ol style="list-style-type: none"> <li>1. Reinstall NetWare.</li> <li>2. Go to Step 2</li> </ol>
The file system on a server	<ol style="list-style-type: none"> <li>1. Reinstall NetWare.</li> <li>2. Go to Step 2.</li> </ol>
Server-specific information	Follow the steps for a custom file system restore.
The file system on a workstation	<ol style="list-style-type: none"> <li>1. Reinstall client software.</li> <li>2. Go to Step 2.</li> </ol>

### 2. Load the drivers for your specific device and controller board, load TSAs, and load SBACKUP. (See “Loading Drivers, TSAs, and Backup Software” on page 610.)

### 3. From the SBACKUP “Main Menu,” choose “Restore.”

**4. Choose a NetWare server running your backup/restore Target Services Agent.**

If you don't see the target you want on the list, check for these possible causes:

- ◆ The proper Target Service Agent isn't loaded on either the host or the target. (For loading instructions, see Table 9-1 on page 611.)
- ◆ The host and target are physically far apart, or network traffic is heavy. In these circumstances, it might take SBACKUP a few moments to detect all of the targets. Press <Esc> to return to the "Main Menu," and then press <Enter> again. Your target should now be listed. From the "Target Services" list, choose a target.

If the target you choose has more than one Target Service Agent loaded, SBACKUP will show you a list of their full names.

**5. Select to restore NDS or the file system to the target.**

**6. When prompted for the target username, enter your username (and context if required) as network supervisor for the target.**

If SBACKUP rejects the supervisor username you entered, you probably need to include the context of where the user object is located. For example, instead of entering "ADMIN" as the username, enter a complete name. For example, ".CN=ADMIN.O=*company\_name*".

You must include the context in the username at this point if the username exists in a Directory container that is different from the context set on the server running SBACKUP.

**7. If a password is requested, enter the password for the target.**

SBACKUP will take a few moments to attach to the target. Wait for the confirmation box; then press any key to continue.

**8. From the “Restore Menu,” select a restore option, using the information in the following table to make your choice.**

<b>Choose one of the following</b>	<b>Then</b>
Select “Choose a Session to Restore” if you want to select a session from a list of session log headers.	Go to Step 8a.
Select “Restore Without Session Files” if you need to select a session directly from the backup media. This is necessary when log and error files are corrupted or accidentally deleted.	Go to Step 9. (Later in the restore session, SBACKUP will display session headers that you can accept or reject one at a time.)

**8a. Specify the path to the session log file of the session you want to restore.**

To specify a path, use one or more of the following methods.

- ◆ Press <Enter> to accept the default; then go to Step 8b.
- ◆ Press <Insert> to choose from a list of directories, press <Esc> to return to the previous window, and then go to Step 8b.
- ◆ Backspace over the path shown (or a portion of the path), type in a new directory or path, and then go to Step 8b.

Press <Insert> anytime during this process to choose parts of the existing path from a list.

**8b. When a list of sessions is displayed, choose the session you want to restore, and then skip to Step 10.**

**9. If you are restoring without session files, set the location of log and error files.**

You can use one or more of the following methods.

- ◆ Press <Enter> to accept the location; then go to Step 10.
- ◆ Press <Insert> to choose from a list of network directories, choose a directory, press <Esc> to return to the previous window, and then go to Step 10.
- ◆ Backspace over the path shown (or a portion of the path), type in a new directory or path, and then go to Step 10.

Press <Insert> anytime during this process to choose parts of the existing path from a list.

**10. Press any key to see your selection of device and media, and decide where you want to restore from.**



If the media on which the data resides is not loaded on the device you choose, you will be prompted to insert the correct media.

If a list of devices and media is displayed, choose the one containing the session you want to restore.

If only one device is attached, a message is displayed indicating the default device and media. Press <Enter>.

**11. From the “Restoring From *Backup\_Session\_Name*” screen, select what you want to restore, using the information in the following table to make your choice.**

If you are restoring	Then
NDS on a single server or an entire tree	Go to “Restore NDS on a Single Server or an Entire Tree” on page 647.
An entire session of NDS	1. Choose “Restore an Entire Session.” 2. Continue with Step 12.
Only selected sections of the Novell Directory tree	Go to “Perform Custom NDS Restore” on page 648.
A single file or directory	Go to “Restore File or Directory to File System” on page 653.

If you are restoring	Then
An entire session of the file system	1. Choose “Restore an Entire Session.”  2. Continue with Step 12.
The server-specific information	Go to “Restore the Server-Specific Information” on page 651.
Only selected sections of the file system	Go to “Perform Custom File System Restore” on page 649.



TSA410 backs up files in compressed or uncompressed format, as specified by the user. However, if you try to restore a compressed file to a volume without compression, the file is corrupted and no error message is given.



If you have installed a migration system built on RTDM (such as HCSS) and need to restore data after a catastrophic data loss, choose “Perform a Custom Restore” and specify when to exclude and include files in the “Subsets of the Session to Be Restored” field.

12. **Press <Enter> to begin the restore session.**
13. **To restore an entire session, at the “Proceed With the Restore?” prompt, choose “Yes.”**
14. **(Conditional) If you selected “Restore Without Session Files” earlier (in Step 8), select a session now.**

Although this method of selecting a session (selecting it directly from the media) is more time-consuming, it is useful when log and error files are corrupted or deleted for some reason.

SBACKUP goes through the media and displays the session headers one at a time, prompting you to specify whether to restore the displayed session or skip to the next session (assuming other sessions have been appended).

Use the table below to assist you.

If	Then
The session you want is displayed	Choose “Yes, Restore This Session” to begin the restore. After a short delay (perhaps as much as a few minutes) the ongoing status is displayed in the windows. Go to Step 15.
The session you want is not displayed	Choose “No, Go On to the Next Session on the Media,” and repeat this step until the session you want is displayed.
You want to quit the restore session	Choose “No, Quit Restore.” The “Restoring From <i>Backup_Session_Name</i> ” screen displays. Go back to Step 11 or continue to exit SBACKUP by pressing <Esc>.

- 15. (Optional) To abort a restore session after choosing “Yes, Restore This Session,” press <Esc> and choose “Yes” from the “Abort Menu.”**

SBACKUP finishes restoring the current data set, then displays a “Dismounting Media” message. Dismounting might take a few minutes.

When the media is dismounted, the “Restore Terminated” message is displayed. Press <Enter> to display the “Restore Menu.”

- 16. Verify that the restore session was successful.**

When the restore session has finished, your screen display should say:

```
The restore process was completed normally.
```

- 17. To return to the “Main Menu,” press <Enter> and then <Esc>.**

The <Esc> key allows you to exit SBACKUP one screen at a time until you reach the “Main Menu.” If you want to exit SBACKUP, press <Esc> once again and answer the confirmation prompt.



To unload SBACKUP and applicable Target Service Agents, see “Unloading SMS Files” on page 657.

**18. (Conditional) Perform the following procedures as necessary to complete the restoration.**

<b>If You are Restoring</b>	<b>Then</b>
Non-SYS: volume	Go to ““Complete the Restore of a Non-SYS: Volume” on page 654.
Volume SYS: in a single-server network	Go to “Complete the Restore of a Single-Server Network” on page 655.
Volume SYS: volume in a multiple-server network	Go to “Complete the Restore of Volume SYS: in a Multiple-Server Network” on page 655.
Entire tree	Go to “Complete the Restore of the Entire Tree” on page 656.

## Beginning Procedures for Restoring NDS

The following section includes procedures that are performed before and during the restore process.

### Begin to Restore a Non-SYS: Volume



Don't delete the volume object for the failed volume from the NDS tree.

Leaving the Volume object preserves any references that other objects (such as Directory Map and Queue objects) may have to that volume.

If the Volume object has been deleted and you have objects that depend on this volume, you will need to reestablish the relationships through a selective NDS restore. See “Restoring Information for Special Conditions” on page 656.

#### Procedure



- 1. At the server console, type “Down.”**
- 2. Replace the failed hardware.**



3. **Bring the server back up and recreate the volume using the INSTALL utility.**
4. **Do a custom file system restore following the “Restoring Data” procedure.**

### **Begin to Restore a SYS: Volume in a Single-Server Network**

Since there are no replicas in a single-server network, you can't recover any NDS information from a replica. After repairing or replacing the failed hardware, you must restore the entire NetWare environment, including NDS, from an SMS backup.

#### **Procedure**



1. **Correct the problem that caused volume SYS: to fail.**
2. **Reinstall NetWare 4 and NDS through the INSTALL utility.**

When INSTALL asks for the names for Organization objects immediately under the Root object, use the same names that existed before in the Directory tree.

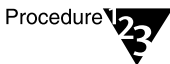
Otherwise you'll end up with new, empty containers in the restored Directory tree.

Make sure disk partitions are at least as large as they were before, and that the volumes are defined as before.

3. **Restore NDS using the “Restoring Data” procedure.**

### **Begin to Restore Volume SYS: in a Multiple-Server Network**

#### **Procedure**



1. **Restore the server-specific NDS information file (SERVDATA.NDS) to another server on the network following the custom file system restore in the “Restoring Data” procedure.**

By default, the file will be placed into the SYS:SYSTEM\*server\_name* directory on the server you have selected.

2. Use the DSMISC.LOG file (part of the information restored with the “server specific information) to see if the failed server had a master replica of any partition.
3. If the failed server had a master replica of any partition, select the server you want to hold the master replica and load DSREPAIR on that machine.
  - 3a. From the “Available Options” menu, select “Advanced Options Menu.”
  - 3b. Select “Replica and Partition Operations.”
  - 3c. Select the partition you want to edit.
  - 3d. To see the list of servers that have replicas of that partition, select “View Replica Ring.”
  - 3e. Press <Esc>.
  - 3f. Choose “Designate This Server as the New Master Replica.”
  - 3g. Repeat Steps 3a through 3f for each master replica that the failed server contained.
4. If the failed server contained any replicas, remove them.
  - 4a. From the “Available Options” menu, select “Replica and Partition Operations.”
  - 4b. Select the partition the server held replicas of.
  - 4c. Select “View Replica Ring.”
  - 4d. Select the name of the failed server.
  - 4e. Select “Remove This Server From the Replica Ring.”
  - 4f. Enter the supervisor’s name and password.
  - 4g. Choose “Yes” to continue.
5. Exit DSREPAIR.



Use the PARTMGR or NDS Manager utility to perform regular partition operations.

**6. Reinstall NetWare 4.**

**6a. Begin the installation as usual.**

**6b. When prompted to choose a Directory tree, press <F5>.**

This will allow you to choose to restore the SERVDATA.NDS file to the failed server.

**6c. To specify the path to where the SERVDATA.NDS file exists, press <F3> and enter the path.**

If the information will fit on a diskette, you can save the information on a diskette instead of another server on the network.

**6d. Press <Enter> to accept the path.**

**6e. Log in to the server that contains the SERVDATA.NDS file.**

**6f. Log in to the Novell Directory database.**

**6g. If the STARTUP.NCF file of the failed server is different than the default, you can edit the default file.**

**6h. You now can choose from the following:**

- ◆ To continue the install and not copy the files from install, but use the backup tapes to finish restoring the information, press <Enter>.
- ◆ To go back to the previous screen, press <Esc>.
- ◆ To copy the files from install, and then restore the files from tape, press <F3>.

**7. Restore the file system using the “Restoring Data” procedure.**

## Begin to Restore the Entire NDS Tree

### Procedure

To restore an entire network from a full backup in a multiple-server environment, complete the following steps.



#### 1. Reinstall NetWare 4 on the first server.

By default, this server will hold the master replica of the [Root] partition.

When INSTALL asks for the names for Organization objects immediately under the Root object, use the same names that existed before in the Directory tree.

Otherwise you'll end up with new, empty containers in the restored Directory tree.

When this installation is complete, you'll have a working Directory tree containing one NetWare 4 server with a master [Root] partition.

#### 2. Load name spaces as needed.

#### 3. Install the remaining servers to complete a "skeleton" of your network.

Before restoring a full NDS session, you should create a "skeleton" of your network:

- ◆ All servers and volumes should be up and running.
- ◆ Their NDS objects should exist in the Directory tree in the same context that they resided in before. (INSTALL will prompt you for which container you want each server to be placed into.)
- ◆ All servers should be communicating with one another.
- ◆ Time synchronization should be working properly.



If you can get some, but not all, of the servers back up, you can still proceed with the restoration. However, you may see errors and experience problems due to NDS objects having dependencies that cannot be resolved.

The User object (such as Admin or equivalent) used to create the backup session should exist in the same container, with the same password and NDS rights, as when the backup was performed.

Once this step is completed, you still have just one partition, the [Root] partition. Because of the INSTALL program's defaults, you now have two replicas of that partition. These are stored on the second and third servers you installed.

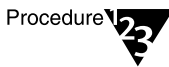
4. **Restore NDS on one server using the “Restoring Data” procedure.**

## Types of Restore Sessions

You can choose to restore NDS to a single server or the entire Directory tree, restore the entire file system, or restore parts of the file system to a server or workstation.

### Restore NDS on a Single Server or an Entire Tree

#### Procedure



1. **Restore the entire NDS session from your SMS backup.**

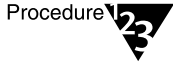
You will have no session files to work from at this point. Choose the option to restore without session files.

2. **Continue with Step 12 of the “Restoring Data” procedure to restore NDS.**
3. **Restore the file system data to volume SYS: from the SMS backup using the “Restoring Data” procedure.**

If the server had other volumes that were unaffected by the failure, you can restore only the trustee assignments for those volumes.

## Restore Session to File System

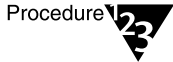
### Procedure



1. At the “Proceed With the Restore?” prompt, choose “Yes.”
2. Continue with Step 12 of the “Restoring Data” procedure.

## Perform Custom NDS Restore

### Procedure



1. To perform a custom restore, at the “Restore Options” screen, complete the form.
  - 1a. Choose “Subsets of the Session to Be Restored” and then edit the form.

The screen allows you to choose to include or exclude containers and objects by their complete name. To specify a subset

(1) Choose any item on the screen.

(2) Edit the “Include” or “Exclude” screen using <Insert>, <Delete> and/or <Enter>.

(3) Press <F10> to save your changes.

- 1b. Specify whether or not to overwrite the existing parent or child.

A parent would be a container. A child is an object, which is the lowest level of the Novell Directory tree structure.

Use the table below to help you decide.

If	Then
You want to overwrite the parent or child that exists on the hard disk, regardless of whether the existing version or the backed-up version has the latest date	Accept the “Yes” default for parent or child or both.
You don’t want to overwrite the parent or child that exists on the hard disk, regardless of whether the existing version or the backed-up version has the latest date	Select the option (parent or child or both), type “N,” and press <Enter>.
You want to overwrite the child that exists on the hard disk only if the date of the backed-up copy on the media is later than the date of the copy on the hard disk	Highlight “Overwrite Existing Child,” press <Enter>, and choose the option.

**2. Continue with Step 12 of the “Restoring Data” procedure.**

## Perform Custom File System Restore

### Procedure



**1. To perform a custom restore, at the “Restore Options” screen, complete the form.**

**1a. Choose “Subsets of the Session to Be Restored” and then edit the form.**

The screen lists major and minor resources. The word “DEFAULT” indicates that none of that type of subset has been specified. To specify a subset

(1) Choose any item on the screen.

(2) Edit the “Include” or “Exclude” screen using <Insert>, <Delete> and/or <Enter>.

(3) Press <F10> to save your changes.

- 1b. **(Conditional) If you want to exclude certain types of data from the restore session, choose “How to Scan the Session to Be Restored” and then edit the form.**

The backed-up data set contains the various types of data items listed on the screen. By default, all types of data items are included in the restore.

If you want to exclude any item, highlight it, type “Y,” and press <Enter> to save your changes. Press <F10> when you are finished editing the form.



Select “Y” for “Delete Existing Trustees Before Restoring” if any part of the file system has remained. This will purge existing trustees before restoring the backed-up trustee assignments from the backup.

- 1c. **(Optional) To restore data to a different workstation or location on a different NetWare server,**

- (1) Back up the data from the server where it resides.

- (2) Exit to the “Main Menu.”

- (3) Choose “Change Target to Back Up From or Restore To” to change your target to the server you want to restore the data to. (See “Changing Targets” on page 675.)

- 1d. **(Optional) To restore data to a different workstation or location within the backed-up server’s file system structure, use the following procedures.**



Some important rules about restoring to a new location:

- (1) When you specify a particular portion of the file system structure as the source location, it does not necessarily mean that this will be the only data restored. You can influence what is restored by using the “Include” and “Exclude” options on the “Choose Subsets Of What You’re Restoring” screen.

- (2) You can only restore to a new location in the name space that is supported by the drive you are restoring to.

- (3) OS/2 workstation only—On an HPFS drive you can only rename in the OS/2 name space, and on a “fat file” system you can only rename in the DOS name space. However, SBACKUP displays both names spaces in the log file even though only one is valid.

- (4) If you do not want to overwrite any subdirectories that might exist in the area you have included, you must specifically exclude them by their full path.

To restore to a new location,



- (1) Select the option, type “Y,” and press <Insert>.
- (2) Enter the full directory path of the source, including the volume name.
- (3) Enter the full directory path to the new destination.
- (4) Press <Esc> to save your changes.



The Novell Directory Services™ Target Service Agent (TSANDS) does not support restoration of data to a different location.

**1e. Specify whether or not to overwrite the existing parent or child.**

A parent might be a server, a volume, or a directory. A child is a file, which is the lowest level of the file system structure.

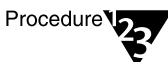
Use the table below to help you decide.

If	Then
You want to overwrite the parent or child that exists on the hard disk, regardless of whether the existing version or the backed-up version has the latest date	Accept the “Yes” default for parent or child or both.
You don’t want to overwrite the parent or child that exists on the hard disk, regardless of whether the existing version or the backed-up version has the latest date	Select the option (parent or child or both), type “N,” and press <Enter>.
You want to overwrite the child that exists on the hard disk only if the date of the backed-up copy on the media is later than the date of the copy on the hard disk	Highlight “Overwrite Existing Child,” press <Enter>, and choose the option.

**2. Continue with Step 12 of the “Restoring Data” procedure.**

**Restore the Server-Specific Information**

**Procedure**



- 1. To restore the server-specific information, choose “Custom Restore.”**

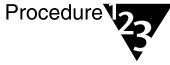
2. On the “Restore Options” screen, choose “Subset of Session to be Restored.”
3. From the “Choose Subset of the Session to be Restored” screen, choose “Include Major TSA Resource.”
4. The “Include Major TSA Resource” screen appears and is empty.
5. Press <Insert> to see the list of resources.
6. Choose “Server-Specific Info.”
7. To accept your choice, press <F10>. This will return you to the “Choose Subset of the Session to be Restored” screen.
8. Complete the form, and then press <F10>. This will return you to the “Restore Options” screen.
9. Complete the “Restore Options” form. To begin the restore process, press <F10>.

The server-specific information will be restored to the SYS:SYSTEM\*failed\_server\_name* directory of the server you are running SBACKUP on.

10. Continue with Step 13 of the “Restoring Data” procedure.

## Restore File or Directory to File System

### Procedure



1. **To restore one file or directory, complete the form in the “Restore Options” screen.**
  - 1a. **To restore one file:**
    - (1) Enter the exact name at “Name of File.”
    - (2) Enter the full path to the file, including the directory and volume names.
    - (3) Skip the “Include Subdirectories” line.
  - 1b. **To restore one directory:**
    - (1) Skip the “Name of File” line.
    - (2) Enter the full directory path, including the volume name.
    - (3) Specify whether or not to include subdirectories.
  - 1c. **(Optional) To restore to a new location, enter the full path to the target directory.**
    - (1) Enter the full directory path, including the volume name, to the new location (a location different from where the data was backed up). Type “*Volume:/directory/directory.*”  
  
If the new location you are restoring to is a different NetWare server:
      - (1) Back up the data from the server where it resides.
      - (2) Exit to the “Main Menu.”
      - (3) Choose “Change Target to Back Up From or Restore To” to change your target to the server you want to restore the data to.
  - 1d. **Enter the name space for the name space format you used when entering the file or directory name.**

The name space allows SBACKUP to correctly interpret the path information entered earlier in this menu in either the directory field or the location field.



If files are restored to a new location, the name spaces must be the same or an error message will occur.



You can only restore to a new location in the name space that is supported by the drive you are restoring to.

On an HPFS drive you can only rename in the OS/2 name space, and on a "fat file" system you can only rename in the DOS name space. However, SBACKUP displays both names spaces in the log file even though when only one is valid.

The supported name spaces are DOS, FTAM, Macintosh, NFS, and OS/2.

SBACKUP provides a list of the name spaces currently loaded on the target you are restoring to.

For example, if you're restoring to a new Macintosh location, enter a path formatted like "SYS::TEST:MONDAY," then enter "Macintosh" as your name space.

2. Continue with Step 12 of the "Restoring Data" procedure.

## Procedures for Completing the Restore

If you have restored the Novell Directory database to volume SYS:, you should complete one of the following procedures to make sure the Novell Directory database is working properly.

### Complete the Restore of a Non-SYS: Volume

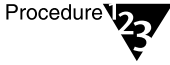
#### Procedure



1. Bring the server back up.
2. (Optional) Verify proper restoration of the data, trustee assignments, file ownership, and other related information by spot-checking some of the restored directories and files.

## Complete the Restore of a Single-Server Network

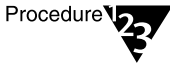
### Procedure



1. Restore the full file system following the “Restoring Data” procedure.
2. (Optional) Verify proper restoration of the data, trustee assignments, file ownership, and other related information by spot-checking some of the restored directories and files.

## Complete the Restore of Volume SYS: in a Multiple-Server Network

### Procedure



1. Restore replicas to the server.

Use the PARTMGR or NDS Manager utility to create partitions and replicas.

A file named DSMISC.LOG, which is created when the SERVDATA.NDS file is restored, contains the partition and replica information that resided on the failed server at the time of the backup. This file can help remind you what replicas were on the server when it failed.

2. (Optional) Verify proper restoration of the data, trustee assignments, file ownership, and other related information by spot-checking some of the restored directories and files.

Commands that might be helpful include RIGHTS /T /S (displays users, groups and other objects that have explicit trustee assignments in a directory and its subdirectories) and NDIR (displays owners and other NetWare file information).

## Complete the Restore of the Entire Tree



### Procedure

1. **Restore the file system information to each server following the “Restoring Data” procedure.**
2. **Re-create partitions and replicas.**  
  
Use PARTMGR or NDS Manager utility to create partitions and replicas.
3. **(Optional) Verify proper restoration of the data, trustee assignments, file ownership, and other related information by spot-checking some of the restored directories and files.**

Commands that might be helpful include RIGHTS /T /S (displays users, groups and other objects that have explicit trustee assignments in a directory and its subdirectories) and NDIR (displays owners and other NetWare file information).

## Restoring Information for Special Conditions

This section describes conditions that may arise in certain special cases involving the backup and restoration of NDS information.

### Partial NDS Restores

The SMS TSA software released with NetWare 4.1 (and later versions) allows you to do selective restores from the backup media. However, partial restoration of NDS from a backup can have many subtle consequences, particularly when only a single object or a selected group of objects is restored.

For partial NDS restores, keep these two main issues in mind:

- ◆ **Object ID numbers**—If you restore objects that no longer exist in the Directory tree, those objects receive new ID numbers when restored. New object IDs affect file system trustees, print queue directories, user mail directories, etc.

If you restore objects on top of objects that exist in the Directory tree, the objects do not receive new ID numbers. These objects' current attribute and property information is overwritten with previous information from the SMS backup.

- ◆ **Objects that depend on other objects**—In the NDS schema, objects are defined to have certain attributes. Some of these attributes are mandatory (meaning they must contain a value); others are optional.

For some NDS objects, the value for a particular attribute is a reference to another object upon which the object depends. For example, Queue object has a Queue Directory attribute that contains the file system path to the queue directory. It also has a Host Server attribute that identifies the file server on which the queue directory resides. This information is used to determine the physical location of the resource.

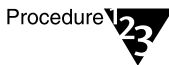
The specifics of restoring objects vary depending on what type of object is involved and whether the object's dependencies are physical entities (servers and volumes) or logical entities.

In some cases, you can simply restore an object by itself and everything will work fine. In other cases, an object may be restored but not be functional unless you first restore its dependent object(s).

## Unloading SMS Files

You can unload SBACKUP if you want to have more memory available on your host or target.

### Procedure



#### 1. **Exit SBACKUP.**

Press <Esc> until you reach the SBACKUP “Main Menu”; then press <Esc> again and choose “Yes” at the confirmation prompt.

## 2. Unload the server SMS files.

To unload the server files, type the following commands at the server console prompt in the order shown:

```
UNLOAD SMSDI <Enter>
UNLOAD TSA410 <Enter>
UNLOAD TSADOS <Enter> (if applicable)
UNLOAD TSAPROXY <Enter> (if applicable)
UNLOAD TSANDS <Enter> (if applicable)
UNLOAD WSMAN <Enter>
UNLOAD SMDR <Enter>
```



The SMSDI, WSMAN, and SMDR files are automatically loaded by SBACKUP and other SMS modules, but they must be unloaded manually.

## 3. Unload the workstation SMS files, if applicable.

To unload the DOS workstation SMS file, type the following command at the workstation prompt.

```
TSASMS /U <Enter>
```

If the workstation had broadcast message reception turned off, turn it back on.

# Other SBACKUP Tasks

Besides backup and restore, you can perform other tasks using SBACKUP:

- ◆ Administer log and error files
- ◆ Administer storage devices
- ◆ Change backup and restore targets
- ◆ Enhance SBACKUP performance

## Prerequisites for Other SBACKUP Tasks



- Ensure that you have loaded the drivers for your specific device and controller board.



- ❑ Ensure that you have loaded the SBACKUP files for your specific target. (See “Loading Drivers, TSAs, and Backup Software” on page 610.)
- ❑ Ensure that media is inserted into your storage device.
- ❑ Ensure that the SBACKUP “Main Menu” is displayed on your server console.

## Log and Error Files

SBACKUP generates a log file and an error file each time a backup session is performed, and records specific information about the session in these files specifically.

SBACKUP also creates a default directory (such as SYS:SYSTEM/TSA/LOG) for the log and error files. If you prefer, you can create any directory for the log and error files, as long as it resides on the host server.



You might want to create individual log directories for the different types of backup or restore session targets or different organizational units. For example, you could create one directory for workstation backups and another for server backups.

SBACKUP keeps a list of all the log and error files. These lists show

- ◆ The description you enter for the session
- ◆ The date and time the session was begun or, in the case of a delayed backup session, the time the session was scheduled
- ◆ The name of the target the data was backed up from

## The Log File

The log file is created on the host server the first time a particular set of data is backed up. This file contains

- ◆ The session date and time and the description you entered
- ◆ The target the data was backed up from
- ◆ Media set identification information
- ◆ The area of the file system structure that was backed up (such as the volume name, directory name, etc.)
- ◆ The names of files that were backed up
- ◆ The numerical location of the data on the storage media

## The Error File

The error file is created on the host the first time a particular set of data is backed up. It contains a list of any errors that occurred during a backup or restore session.

This file also contains

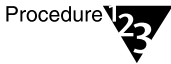
- ◆ The session date and time and the description you entered
- ◆ The target the data was backed up from
- ◆ Media set identification information
- ◆ The area of the file system structure that was backed up
- ◆ The total number of parents and children that were backed up
- ◆ The names of files that were not backed up, along with any error messages or information
- ◆ Skipped data sets (any file that is open when a backup session begins is not backed up and is listed as a skipped data set)

# Viewing a Log File



## Prerequisites

- Ensure that you have met the prerequisites detailed in “Prerequisites for Other SBACKUP Tasks” on page 658.



## Procedure

1. **From the SBACKUP “Main Menu,” choose “Log/Error File Administration.”**
2. **Choose “View a Log File.”**
3. **If necessary, set the location of the log and error files.**

To set the location, use one or more of the following methods.

- ◆ Press <Enter> to accept the default location, and then go to Step 5.
- ◆ Press <Insert> to choose from a list of network directories, choose a directory, and then press <Esc> to return to the previous window; then go to Step 4.
- ◆ Backspace over the path shown (or a portion of the path), then type in a new directory or path, and then go to Step 5.

You can also press <Insert> during this process to choose existing parts of the path from a list.

The backup log displays all supported name space types. The DOS name space is the first in the group. A right angle bracket (>) appears next to the file creator’s name-space type.

If you have linked UNIX files, SBACKUP retains both symbolic and hard links created under the NFS name-space type, but links are not listed in the backup log. Restoring the original file restores associated links.

4. (Optional) You can do a search in the log file.
  - 4a. Press <F2> and enter the exact text you want to search for.

The search is case-sensitive and must be an exact match.
  - 4b. To begin the search, press <Enter>.
  - 4c. To continue the search after a find, press <Shift>+<F2>.
5. To return to the “Main Menu,” press <Enter> and then <Esc>.

The <Esc> key allows you to exit SBACKUP one screen at a time until you reach the “Main Menu.” If you want to exit SBACKUP, press <Esc> again and answer the confirmation prompt.



To unload SBACKUP and applicable Target Service Agents, see “Unloading SMS Files” on page 657.

## Viewing an Error File

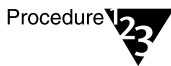
An error file records any errors that occurred during the backup or restore session. (See “The Error File” on page 660.)

### Prerequisites



- Ensure that you have met the prerequisites detailed in “Prerequisites for Other SBACKUP Tasks” on page 658.

### Procedure



1. From the SBACKUP “Main Menu,” choose “Log/Error File Administration.”
2. Choose “View an Error File.”

### 3. If necessary, set the location of log and error files.

To set the location, use one or more of the following methods.

- ◆ Press <Enter> to accept the default location, and then go to Step 4.
- ◆ Press <Insert> to choose from a list of network directories, choose a directory, and then press <Esc> to exit; then go to Step 4.
- ◆ Backspace over the path shown (or a portion of the path), and type a new directory or path; then go to Step 4.

You can also press <Insert> during this process to choose existing parts of the path from a list.

Restore errors are appended to a session's backup error file. A "Restore Session Begins" message marks the beginning of the restore errors, if any exist.

If you have linked UNIX files, symbolic and hard links created under the NFS name-space type might not be restored if the path name is not recognized. When this happens, the error file contains messages similar to the following:

```
Error restoring name space specific information
of "XXXX:tmp/hosts" in NFS name space, error 0x7!
Unable to allocate directory handle for
  "XXXX:tmp/test"!
```

### 4. When you are finished viewing the file, press <Esc>.

### 5. To return to the "Main Menu," press <Esc> three times.

The <Esc> key allows you to exit SBACKUP one screen at a time until you reach the "Main Menu." If you want to exit SBACKUP, press <Esc> again and answer the confirmation prompt.



To unload SBACKUP and applicable Target Service Agents, see "Unloading SMS Files" on page 657.

## Creating Log and Error Files

If you don't know what is on the media, or you have lost or deleted the log and error files, you can re-create them.

Checklist



### Prerequisites

- Ensure that you have met the prerequisites detailed in “Prerequisites for Other SBACKUP Tasks” on page 658.

Procedure



### Procedure

1. **From the SBACKUP “Main Menu,” choose “Log/Error File Administration.”**
2. **Choose “Create Session File.”**
3. **You are asked to set the location of the log and error files.**

To set the location, use one or more of the following methods.

- ◆ Press <Enter> to accept the default location.
- ◆ Press <Insert> to choose from a list of network directories, choose a directory, and press <Enter>.
- ◆ Backspace over the path shown (or a portion of the path), type a new directory or path, and press <Enter>.

You can also press <Insert> during this process to choose existing parts of the path from a list.

4. **Choose the media you will be using. If you only have one loaded, press <Enter> to accept the default.**
5. **To verify the media, press <Enter>.**
6. **SBACKUP reads the media and asks you to confirm the creation of the session files.**

If the session selected is the session you want log and error files created for, choose “Yes, Create Files for This Session.”

If the session selected is not the session you want log and error files created for, choose “No, Go to the Next Session.”

If you want to cancel the search of the current media, choose “No, Quit Scanning Sessions.”

7. **If you select to create session files, they will be created in the location you chose.**

## Setting Location of Log and Error Files

Every time you do a backup or restore, you are required to set a location (or directory path) for the log and error files.

You can set the location when requested in the backup or restore procedures, or you can use the following method prior to beginning the backup or restore procedures.

### Prerequisites



- Ensure that you have met the prerequisites detailed in “Prerequisites for Other SBACKUP Tasks” on page 658.

### Procedure



1. **From the SBACKUP “Main Menu,” choose “Log/Error File Administration.”**
2. **Choose “Set Location of Log and Error Files,” and set the location.**

To set the location, use one or more of the following methods.

- ◆ Press <Enter> to accept the default location, and then press <Esc> to return to the “Main Menu.”
- ◆ Press <Insert> to choose from a list of network directories, choose a directory, and press <Esc> twice to return to the “Main Menu.”
- ◆ Backspace over the path shown (or a portion of the path), type a new directory or path, press <Enter>, and then press <Esc> to return to the “Main Menu.”

You can also press <Insert> during this process to choose existing parts of the path from a list.

3. **Press <Esc> when finished to return to the “Main Menu.”**

## Deleting the Log Files for Overwritten Sessions

SBACKUP allows you to overwrite sessions and reuse storage media.

When you delete the log file for a session using the following procedures, you automatically delete the corresponding error file as well.



Hint

To prevent outdated session information from taking up disk space and to help prevent confusion when you select sessions to view or restore, delete the session log files of any sessions that have been overwritten.

### Prerequisites



Checklist

- Ensure that you have met the prerequisites detailed in “Prerequisites for Other SBACKUP Tasks” on page 658.

### Procedure



Procedure

1. From the SBACKUP “Main Menu,” choose “Log/Error File Administration.”
2. Choose “View a Log File.”
3. If you have not set the location of log and error files, do so now.

You can use one or more of the following methods.

- ◆ Press <Enter> to accept the default location; then go to Step 4.
- ◆ Press <Insert> to choose from a list of directories, choose a directory, and press <Esc> to return to the previous window; then go to Step 4.
- ◆ Backspace over the path shown (or a portion of the path), and type a new directory or path; then go to Step 4.

You can also press <Insert> during this process to choose existing parts of the path from a list.



4. **Select the description of the session that you have overwritten (or plan to overwrite) and press <Delete>.**

To delete several session files at once, select each one using <F5>; then, when finished marking, press <Delete>.

A confirmation prompt is displayed.

5. **To delete the log and error file for that session, choose “Yes.”**
6. **Press <Esc> when finished to return to the “Main Menu.”**

## Verifying Backup Data

This option allows you to check the data on the media to make sure it has been backed up properly, and to check at some later point in time that the data is still good and can be restored.

You can choose to verify the backup data in two ways.

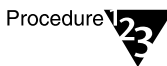
- ◆ If you know what sessions are on the media and you have the log and error files, you can choose the session from the list.
- ◆ If you don't know what session are on the media, and you're not sure the log and error files are still around, you should choose the session from the media.

### Verify Data by Choosing the Session From the List



#### Prerequisites

- Ensure that you have met the prerequisites detailed in “Prerequisites for Other SBACKUP Tasks” on page 658.



#### Procedure

1. **From the SBACKUP “Main Menu,” choose “Verify.”**
2. **From the “Verify Menu,” choose “Select Session from List.”**

### 3. Choose the location of the log and error files.

You can use one or more of the following methods.

- ◆ Press <Enter> to accept the default location.
- ◆ Press <Insert> to choose from a list of directories, choose a directory, and press <Esc> to return to the previous window.
- ◆ Backspace over the path shown (or a portion of the path), and type a new directory or path.

You can also press <Insert> during this process to choose existing parts of the path from a list.

### 4. Choose the session you want to verify.

### 5. Choose the backup device. If there is only one, press <Enter> to accept it.

### 6. Choose the media. If there is only one, press <Enter> to accept it.

### 7. The data for that session will be verified.

If there were no problems with the verification or the data, you will receive the following message:

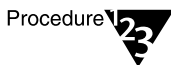
```
The verification process was completed normally.
```

## Verify Data by Choosing the Session From the Media



### Prerequisites

- Ensure that you have met the prerequisites detailed in “Prerequisites for Other SBACKUP Tasks” on page 658.



### Procedure

1. From the SBACKUP “Main Menu,” choose “Verify.”
2. From the “Verify Menu,” choose “Select Session from Media.”

**3. Choose the location of the log and error files.**

You can use one or more of the following methods.

- ◆ Press <Enter> to accept the default location.
- ◆ Press <Insert> to choose from a list of directories, choose a directory, and press <Esc> to return to the previous window.
- ◆ Backspace over the path shown (or a portion of the path), and type a new directory or path.

You can also press <Insert> during this process to choose existing parts of the path from a list.

**4. Choose the backup device and media. If there is only one, press <Enter> to accept it.**

**5. To accept the media, press <Enter>.**

**6. SBACKUP reads the media and asks you to confirm the session to verify.**

If the session selected is the session you want to verify, choose “Yes, Verify This Session.”

If the session selected is not the session you want to verify, choose “No, Go to the Next Session.”

If you want to cancel the search of the current media, choose “No, Quit Scanning Sessions.”

**7. If you choose to verify a session, it will be verified. If there were no problems with the verification or the data, you will receive the following message:**

The verification process was completed normally.

# Administering Storage Devices

You can see a list of available storage devices by choosing “Storage Device Administration” from the SBACKUP “Main Menu.” For each listed device, you can access the following information, using the options listed at the bottom of the screen:

- ◆ Viewing media lists
- ◆ Checking status of a device
- ◆ Checking status of media in a device
- ◆ Media utilities
- ◆ Renaming a storage device
- ◆ Managing storage media

## Viewing Media Lists

This option lists the available media for the highlighted device, and provides the location and media name.

### Prerequisites



- Ensure that you have met the prerequisites detailed in “Prerequisites for Other SBACKUP Tasks” on page 658.

### Procedure



1. **From the SBACKUP “Main Menu,” choose “Storage Device Administration.”**

2. **Select one device name and press <Insert>.**

If a message indicates that no media is in the device but you know that there is, return to the device list and press <Enter>. This will force the media to be read.

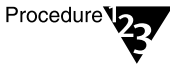
3. **Press <Esc> when finished to return to the “Main Menu.”**

## Checking Status of a Device



### Prerequisites

- Ensure that you have met the prerequisites detailed in “Prerequisites for Other SBACKUP Tasks” on page 658.



### Procedure

1. From the SBACKUP “Main Menu,” choose “Storage Device Administration.”
2. Select one device, and press <Tab>.

The “Status of: *Device\_Name*” screen is displayed, listing the following:

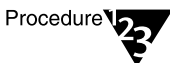
- ◆ **Current operation:** This option indicates whether the device is currently reading, writing, formatting the media, or none of these.
  - ◆ **Device mode:** This option indicates whether the device is selected for reading, writing, or both.
  - ◆ **Maximum capacity:** This option indicates the total storage capacity of the media currently in the device.
3. Press <Esc> when you are finished to return to the “Main Menu.”

## Checking Status of Media in a Device



### Prerequisites

- Ensure that you have met the prerequisites detailed in “Prerequisites for Other SBACKUP Tasks” on page 658.



### Procedure

1. From the SBACKUP “Main Menu,” choose “Storage Device Administration.”
2. Select one device name, and press <Insert>.

If a message indicates that no media is in the device, but you know that there is, return to the device list and press <Enter>. This will force the media to be read.

**3. Select one media name, and press <Tab>.**

The “Status of: *Media\_Name*” screen is displayed, listing the following:

- ◆ **Media owner:** If the media in the device is blank or if it was written to in a data format other than SDF, the owner is listed as “Unidentified.”



If the media is written by an SDF application, the media owner is not displayed on the status screen.

- ◆ **Number in media set:** This number indicates the sequential number of this media within a particular media set.

SBACKUP automatically labels and appends an incrementing number to any backup sessions that spans multiple media.

- ◆ **Creation time:** This shows the time that the current media label was first used on this media.
- ◆ **Mount status:** This indicates whether the media is “Mounted” (ready for reading or writing), “Mount Pending” (request to mount is waiting to be processed), or “Not Mounted.”
- ◆ **Media mode:** This indicates whether the media is selected for reading, writing, or both, or whether the mount request is pending.
- ◆ **Media type:** This indicates the type of media in the device, such as 4mm DDS (Digital Data Storage) tape, 8mm tape, etc.
- ◆ **Total capacity:** This indicates the total capacity of this media, if it is known.

**4. Press <Esc> when you are finished to return to the “Main Menu.”**

## Using Media Utilities

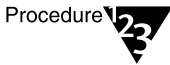
Use the following procedures to erase media headers, to erase all data on the media, or to re-tension media in tape devices.

### Prerequisites



- Ensure that you have met the prerequisites detailed in “Prerequisites for Other SBACKUP Tasks” on page 658.

### Procedure



- 1. From the SBACKUP “Main Menu,” choose “Storage Device Administration.”**
- 2. Select one device name, and press <Insert>.**  
  
If a message indicates that no media is in the device, but you know that there is, return to the device list and press <Enter>. This will force the media to be read.
- 3. Select one media name, and press <Insert>.**
- 4. From the “Utilities For: *Media\_Name*” menu, choose one option.**

The following table explains each option.

Option	Explanation
“Erase the Media Header”	This is a quick method of making the media appear blank. Although this is less secure than erasing all of the data, this method is quick and effective.
“Erase All Data on the Media”	This is a security measure that might take up to two hours, depending on the size of the media.

Option	Explanation
"Re-tension This Media"	This option is for tape devices that allow re-tensioning (0.25-inch cartridges, for example). This will fast-forward and rewind the tape, which might resolve a problem reading the tape.

## Renaming a Storage Device

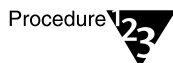
The default names for storage devices are controlled by the devices. These names are often not descriptive. If you have several devices, it might be difficult to remember which name goes with which device. For this reason, renaming storage devices might be helpful.

### Prerequisites



- Ensure that you have met the prerequisites detailed in "Prerequisites for Other SBACKUP Tasks" on page 658.

### Procedure



1. **From the SBACKUP "Main Menu," choose "Storage Device Administration."**
2. **Select the device name that you want to rename, and press <F3>.**
3. **Type a new name or identifier for the device, and press <Enter>.**
4. **Press <Esc> when finished to return to the "Main Menu."**



Any new device names that you assign are lost if the NetWare server goes down. When you load the SBACKUP module after the server has been down, the device names revert to the default.



## Managing Storage Media

If the storage media you are using does not have enough empty space for the entire backup, SBACKUP will span media, prompting you to insert additional media when the first is full.



Hint

Always have extra media on hand in case the backup session spans more than one media.

SBACKUP designates the first media that has a particular label as #1 and increments any subsequent media with the same label.



Warning

To help safeguard your network, SBACKUP disconnects from the target when a delayed backup is complete. If the delayed backup session cannot fit on the media, SBACKUP prompts you to insert additional media. If additional media is not inserted, the backup does not finish and SBACKUP does not disconnect, thus compromising security.

## Changing Targets

Anytime you are performing a series of backup or restore sessions, you may need to change your target. This is easily done from the SBACKUP “Main Menu.”

If you don’t specify a new target, SBACKUP automatically selects the target used during the last session and continues without asking you to make a selection.

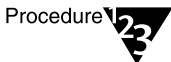
### Prerequisites



Checklist

- Ensure that you have met the prerequisites detailed in “Prerequisites for Other SBACKUP Tasks” on page 658.

### Procedure



Procedure

1. From the SBACKUP “Main Menu,” choose “Change Target to Back Up From or Restore To.”
2. Choose one server.

**3. From the list of Target Service Agents, choose a target.**

If the target you choose has more than one Target Service Agent loaded, SBACKUP will show you a list of their full names.

**4. Type in the username and password for the target you just selected.**

## Enhancing SBACKUP Performance

This section gives suggestions for making SBACKUP run more efficiently.

### Compressed Files

When a NetWare 4.1x volume is mounted, file compression is set to ON by default. When you perform a backup using TSA410, you can specify whether to keep already-compressed files in a compressed state for the backup, or back them up in an uncompressed state.

To help you make your decision, remember these points:

- ◆ The backup is faster if files already compressed are left compressed.
- ◆ Compression is not supported in some environments (for example, on a NetWare 3.11 server or a DOS workstation). Therefore, if you intend to restore a file that is currently compressed to an environment that does not support compression, you should back it up in an uncompressed state.
- ◆ The SBACKUP utility itself has no compression feature, so it cannot compress a file that is currently uncompressed.
- ◆ If volume compression is turned on and you back up compressed files in an uncompressed state, restore speed is degraded if you overwrite existing files.

To improve restore speed, delete the files you no longer want from the hard disk before restoring them from the backup media. If you back up compressed files in a compressed state, restore speed is not affected.



- ◆ You might run out of disk space if you restore uncompressed files to a volume that compresses files.

SBACKUP and file compression should not be run simultaneously. However, the default time for both delayed SBACKUP sessions and compression is midnight of the current day.

If you want to perform a delayed backup that includes files flagged for compression, schedule the delayed backup after the compression time to allow time for the compression to be completed.

## Enhancing Host Server Performance

The speed of the SBACKUP utility depends upon the host server's configuration and whether or not the server is backing up its own data or that of another server or workstation.

For information on server configuration and setting parameters, see "Communication Parameters" and "File Caching Parameters" under "SET" in *Utilities Reference*.

A server backing up its own data runs about twice as fast as a server backing up data from another server.

This section includes four options using LOAD and SET commands that can enhance your host server's performance:

- ◆ Changing the size or number of buffers
- ◆ Setting minimum packet receive buffers
- ◆ Setting subdirectory levels and minimum cache buffers
- ◆ Setting reserved buffers below 16 MB

## Changing the Size and Number of Buffers

If your server has sufficient free memory, or if it has memory not being used, you can speed up a backup session by increasing the number and size of the transfer buffers used by SBACKUP to move the data to or from tape.

You can change the size and number of buffers when you load SBACKUP. To do this, type:

```
LOAD SBACKUP SIZE=XXX BUFFER=X <Enter>
```

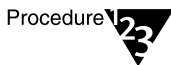
Select the size and number of buffers from the following chart:

Option	Range
Size	16, 32, 64, 128, or 256 KB (Default: 64 KB)
Buffers	2 to 10 (Default: 4)

## Setting Minimum Packet Receive Buffers

Packet receive buffers represent the space in the server memory dedicated to handling network traffic. If the buffers are set too low, the server performance may be degraded.

### Procedure



1. **Include the following SET command in your STARTUP.NCF file:**

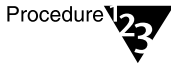
```
SET MINIMUM PACKET RECEIVE BUFFERS = X
```

The *x* represents the number of buffers. Set two buffers for each user on the system. The minimum is 10.

2. **To activate the changes, bring down the server and bring it back up.**

## Setting Maximum Subdirectory Level and Minimum Cache Buffers

If you change the maximum subdirectory level in the server's STARTUP.NCF file, you must also change the minimum cache buffers. The default maximum subdirectory level is 25.



### Procedure

1. Include the following commands in the **AUTOEXEC.NCF** file:

```
SET MINIMUM FILE CACHE BUFFERS=X  
SET MAXIMUM DIRECTORY CACHE BUFFERS=X
```

2. To activate the changes, bring down the server and bring it back up.

## Setting Reserved Buffers Below 16 MB

If your storage device driver requires memory below 16 MB and the server has more than 16 MB available to it, you must reserve memory below 16 MB for the driver.

### Procedure



1. Include the following command in the **STARTUP.NCF** file:

```
SET RESERVED BUFFERS BELOW 16 MEG=X
```

Replace the *x* with a number between 8 and 300. The default is 200.

2. To activate the changes, bring down the server (type **DOWN** at the server console prompt) and reboot it.

# Troubleshooting

If you have trouble while using SMS, use Table 9-3 to help you determine and resolve the problem.

**Table 9-3**  
**Troubleshooting Guide for SBACKUP Problems**

<b>Problem</b>	<b>Possible cause</b>	<b>For more information, see</b>
The media owner is "Unidentified."	Media is blank or was written in a non-SIDF format.	"Checking Status of Media in a Device" on page 671
Backup speed is slow.	Compressed files are being backed up in an uncompressed format.	"Enhancing SBACKUP Performance" on page 676
Restore speed is slow.	File compression and SBACKUP are running at the same time.  Compressed files are being overwritten with uncompressed files.	"Enhancing Host Server Performance" on page 677
Data is corrupted.	Volumes were mounted or dismounted or drivers were unloaded during a session.	"Using SBACKUP" on page 594
Data is corrupted, but no error message was given.	Compressed files were restored to a volume without compression.	"Restoring Data" on page 635
The server is in an abend condition.	Volumes were mounted or dismounted or drivers were unloaded during a session.	"Using SBACKUP" on page 594
The specified file or directory cannot be found.	Incorrect spelling was used, or the incorrect case was used for case-sensitive name spaces.	"Using SBACKUP" on page 594
The target you want is not listed.	The Target Service Agent isn't loaded on the desired target.  SBACKUP has not had time to "find" the target.  The host and target are physically far apart and network traffic is heavy.	"Backing Up Data" on page 613  (Not applicable)  (Not applicable)

Table 9-3 *continued*

**Troubleshooting Guide for SBACKUP Problems**

<b>Problem</b>	<b>Possible cause</b>	<b>For more information, see</b>
You (network supervisor) can't back up a workstation.	The "/Password" option is set and is denying access to data on the workstation.	Table 9-2 on page 625
	Other CPU-intensive applications were running, and they did not allow the workstation TSR to obtain resources.	(Not applicable)
	Backup was attempted from two different servers at the same time. One succeeded and the other one failed.	(Not applicable)
A backup does not contain all changes.	Differential and incremental backups were combined. Use one or the other of these types in conjunction with full backups.	"Backup Types" on page 596
	The modify bit was cleared after the last custom backup, so changed files are not recognized.	"Backup Types" on page 596
You cannot find the session log file you want.	It might be in a different directory, or you might have deleted it accidentally.	"Deleting the Log Files for Overwritten Sessions" on page 666
Pressing <Insert> on device list does not produce a media list.	No medium has been selected.	"Select" option at the bottom of the screen.
"The time form is invalid" message is displayed when you try to schedule a delayed backup.	The date has been entered incorrectly in the time form. Press <F1> for help with the time or date format.	(Not applicable)
Files were restored but the error file contains a message specifying which name space formats were not restored.	The file attributes and name space formats are not configured on the volume you restored to.	(Not applicable)





# 10 *Managing NetWare Licensing Services*

This chapter describes the NetWare<sup>®</sup> Licensing Services (NLS) technology and provides procedures for using NLS to more effectively manage software use licenses on a NetWare network.

## Understanding Software Licensing

Almost all legitimate computer software use is regulated by an explicit license. The license typically states who may use the software and under what conditions. There are many different types of licenses, each of which reflects the intended use of the software.

Until recently, software use licenses were often nothing more than a printed license statement included in the product's packaging. Software vendors relied on the integrity of their customers to not violate the license; in many cases, this was sufficient to protect the vendor's investment in developing the software.

However, in an attempt to further reduce losses that result from illegal software distribution and use, a group of software developers have written the Licensing Service Application Programming Interface (LSAPI).

NetWare Licensing Services (NLS) is the means provided by Novell<sup>®</sup> by which applications that are written to the LSAPI specification can be managed in a NetWare environment.

To take advantage of NLS, the software in use on your network must incorporate the LSAPI specification. For information on whether the software you use is written to the LSAPI specification, contact the appropriate software vendors.

# Understanding NetWare Licensing Services

NetWare Licensing Services (NLS) is a distributed, enterprise network service that enables administrators to monitor and control the use of licensed applications on a network.

NLS is tightly integrated with the Novell Directory Services™ (NDS™) technology and is based on an enterprise service architecture. This architecture consists of client components that support different platforms and system components that reside on NetWare 4.11 servers.

NLS also provides a basic license metering tool, as well as libraries that export licensing service functionality to developers of other licensing systems.

## NLS Components

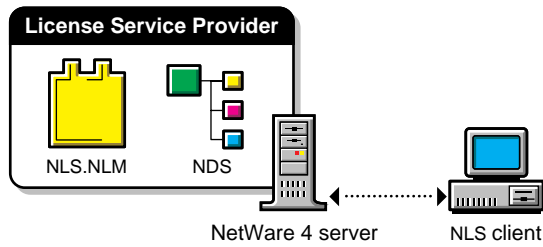
As indicated in Figure 10-1, NLS consists of the following components:

- ◆ One or more License Service Providers (LSPs) loaded on NetWare 4.11 servers. An LSP server is a NetWare 4.11 server with the NLS NetWare Loadable Module™ program (NLS.NLM) loaded.

By default, when you install NLS, an LSP Server object is created in the Directory that represents the LSP server. The LSP Server object is placed in the same context as the NetWare Server object that represents the NetWare 4.11 server on which you installed the NLM™ program.

- ◆ Platform-specific client components—NLS supports DOS, Windows\* 3.1x, Windows 95\*, and NetWare 4.11 NLM clients.
- ◆ Novell Directory Services.
- ◆ Transaction databases (not represented in Figure 10-1).

Figure 10-1  
NLS Components



## License Service Providers

A License Service Provider (LSP) is a NetWare Loadable Module program that responds to requests from LSAPI-compliant clients for licenses to use or for licensing information. It may help to think of LSPs as “brokers,” handling requests from clients by interacting with the Novell Directory database.

You do not need to have an LSP loaded on every server. An NLS installation requires only one LSP with access to the Directory database. However in larger environments, using multiple LSPs enables NLS to work more efficiently.

The following steps describe the process by which an LSP responds to a license resource request:

1. A licensing service-enabled application issues a request to the licensing service.
2. A client-specific component packages the request and submits it to the nearest connected LSP server.

If the client is not connected to a server with the LSP software loaded, the client checks the Directory database, searching the Directory tree for an LSP Server object. For more information on NLS clients, see “NLS Clients” on page 686.

3. The LSP examines the request and checks the Directory to determine whether it can fill the request. It does this by checking the current context for available license certificates.
4. If the requested resource or information is available, the LSP responds.

5. If the LSP cannot fill the request, it checks the next higher context in the Directory database for the necessary resources.

## LSP Server Objects

As the process by which the LSP software responds to a license resource request indicates, NLS is tightly integrated with Novell Directory Services. In fact, when you install NLS, each LSP server is registered with the Directory to facilitate Step 2 on page 685.

When an LSP server is registered with the Directory, an LSP Server object is created in the same context as the NetWare Server object on which it is loaded. Following installation, you can delete the LSP Server object, or it can be moved to another context in the Directory. You might want to delete or move LSP Server objects to control access to licensing resources or to facilitate the process by which NLS responds to a license resource request.

In addition to an LSP Server object, when you first install NLS on a server, a set of group objects is created. The NLS install program creates a License Servers Group object in each of the Organization container objects in the Directory. As you install NLS on additional servers, the names of the NetWare Server objects that represent those servers are added to the “Group Members” list of the License Servers Group objects.

For more information on the integration between NLS and NDS, see “NLS and NDS: Considerations” on page 688.

## NLS Clients

An NLS client consists of the following components:

- ◆ An application that requests services of NLS. The application might be a product such as GroupWise™ or a license usage metering utility.
- ◆ A platform-dependent licensing system software component. This is a static library/TSR combination (DOS) or a set of dynamic libraries (Windows).

The client components of NLS enable applications to access the licensing service. There are two types of access to the licensing service that applications might require:

- ◆ Access to license certificates (objects in the Directory) that conform to the industry-standard common licensing API (LSAPI). This access is necessary for applications (clients) that use the licensing service to control or monitor use.

The components required for this type of access are platform-specific (DOS, Windows, and NLM programs) and are described in Table 10-1.

- ◆ Access to administrative or management functions offered by the licensing service. This type of access is required by utilities such as NLS Manager.

NLS supports DOS, Windows (Windows 3.1x and Windows 95), and NetWare 4.11 NLM clients. The files required to support each client type are listed in Table 10-1.

**Table 10-1**  
**Files Required by NLS Client Types**

Client type	Required files
DOS	<p>A static library file and TSR (terminate-and-stay-resident) program provide license resource access for DOS clients. The appropriate static library file is used by software developers when they write a licensed application.</p> <p><b>NLSLSAPI.EXE.</b> An LSAPI-compliant TSR for NetWare Licensing Services. This TSR must be loaded before the DOS client application is executed; otherwise, an error is returned for any LSAPI function.</p>
Windows	<p><b>LSAPI.DLL.</b> A generic LSAPI v1.1 client component for accessing any licensing service. LSAPI.DLL reads the LICENSE.INI file and loads the appropriate client components.</p> <p><b>NLS.DLL and NLS32.DLL.</b> NLS-specific client components that enable license resource access for Windows clients.</p>

Table 10-1  
Files Required by NLS Client Types

Client type	Required files
NLMs	<p><b>LSAPI.NLM.</b> A shared library NLM that provides LSAPI v1.1 calls for NLM clients. This module should be loaded before the licensed NLM.</p> <p><b>NLSAPI.NLM.</b> A shared-library NLM that provides access to NLS management functions. This module should be loaded before the licensed NLM.</p>

## NLS and NDS: Considerations

NetWare Licensing Services (NLS) software is tightly integrated with Novell Directory Services (NDS). This integration occurs in the following ways:

- ◆ NLS License Service Providers (LSPs) are registered with the Directory database, providing NLS clients with a means for finding an LSP server when they are not currently connected to one.

When an LSP server is registered with the Directory, an LSP Server object is created in the same context as the NetWare Server object on which it is loaded. Following installation, you can delete the LSP Server object, or it can be moved to another context in the Directory. You might want to delete or move LSP Server objects to control access to licensing resources or to facilitate the process by which NLS responds to a license resource request.

- ◆ When you first install NLS on a server, a set of NDS Group objects is created. The NLS install program creates a License Servers Group object in each of the Organization container objects in the Directory. As you install NLS on additional servers, the names of the NetWare Server objects that represent those servers are added to the License Servers Group object.

- ◆ NLS license certificates are stored as objects in the Directory database.

When an NLS-enabled application is installed, the application's install program should add a Licensed Product container object to the Directory database and a License Certificate object to that container.

This integration reduces NLS-associated network traffic and eases manageability.

## Configuration Issues

Because NLS relies on the Directory database to store license certificates, the efficiency of the licensing service is directly affected by the location of NLS-related Directory objects in the Directory tree. This dependence is evident in two relationships:

- ◆ NLS client location with regard to the nearest LSP
- ◆ NLS client location with regard to assigned license certificates

Keep these relationships in mind as you use NLS. Otherwise, you might inadvertently assign a user to a license certificate that cannot be accessed, or an application's startup time might be significantly longer than normal.

### Clients and LSPs

An NLS client can locate an LSP server in two ways:

- ◆ If the client has an existing connection to an LSP server, the client simply reads its connection table and contacts the LSP.
- ◆ If the client does not already have a connection to an LSP server, the client must search for a server that provides licensing services.

The client searches the Directory tree, beginning with its current context. If an LSP Server object does not exist in the client's current context, the client searches the direct parent of the current context. This process continues until the client finds an LSP or until it searches unsuccessfully up to the root of the Directory tree.

Because this particular search pattern is used to locate an LSP server, some clients might not have access to licensing services if LSP Server objects are not well placed in the Directory tree.

For example, since a container object's siblings are not searched, a client might not have access to licensing services if all your LSP Server objects are placed at a single level of the Directory tree hierarchy.

Ideally, at least one LSP Server object should be placed in a container near the root of the tree. Also, if possible, each workgroup or main server in the Directory tree should have the LSP software loaded. This distributes license resource requests among the various available LSPs.

### **Clients and License Certificates**

When an NLS client requests licenses to use from an LSP server, the LSP server must locate the appropriate license certificate in the Directory. The LSP server begins by searching for the License Certificate object in the user's current context. If the license certificate is not found or there are no available license units, the LSP searches the parent context. If it is still unsuccessful, the LSP continues searching up to the root of the Directory tree.

To use this search process to your advantage, there are a few things you can do to ensure that license units are readily available to those who need them:

- ◆ For license certificates that will be used by many users throughout the Directory tree, place them in a context near the root of the Directory tree.
- ◆ For license certificates that are used by a small group, place them in the same Directory context as those users' objects.
- ◆ For license certificates that are used by a larger group, place them in the Directory context that represents the root-most context for the group.
- ◆ Place license certificates so that NLS clients do not have to traverse slow WAN links to access license units.



Each of these suggestions is based on a single idea: place license certificates as close as practical to the actual users but high enough in the Directory tree hierarchy so that everyone who needs to access them can do so.

Keep in mind that a cross-container search does not occur for license certificates. Therefore, certificate placement can inherently restrict access by users located above that container.

## NDS Security

In addition to considering where NLS-related objects are placed in the Directory tree, there are two additional points you should consider when using NLS:

- ◆ Each license certificate is assigned an owner. By default, this owner is the full Distinguished Name of the Directory object used to log in when the License Certificate object was added to the Directory database.

A certificate's ownership is independent of any Directory object trustee assignments. A trustee assigned to a License Certificate object is *not* the certificate's owner.

Also, only a certificate's assigned owner (or an object that is security equivalent to the assigned owner) can make user assignments to a license certificate or transfer ownership.

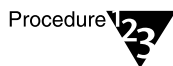
- ◆ A license certificate owner can assign users to a license certificate. Typically, once an assignment is made, only those objects that are explicitly assigned to a certificate can use the license units associated with that certificate.

Of course, an object that is security equivalent to an assigned user can also access those license units.

# Installing NetWare Licensing Services

From the system console of each server you want to use as an LSP server, you must run the NetWare INSTALL utility to install the server components of NLS.

## Procedure



1. **To load INSTALL on the server, type the following command at the console prompt:**

```
LOAD INSTALL <Enter>
```

2. **Select “Product Options” and press <Enter>.**
3. **Select “Choose an Item or Product Listed Above” and press <Enter>.**
4. **From the “Other Installation Items/Products” list, select “Install NetWare Licensing Services” and press <Enter>.**
5. **When prompted, type a username and password and press <Enter>.**

The username you enter must be for a Directory object that has rights to add objects to the Organization container objects in the Directory.

6. **When the installation is complete, press <Esc> to exit the INSTALL utility.**

The NLS install program makes the following changes:

- ◆ It creates License Servers Group objects in each Organization container object in the Directory.
- ◆ It places the name of the NetWare Server object that represents the server on which you just installed the NLS software in the License Servers group.

- ◆ It creates an LSP Server object in the same Directory context as the NetWare Server object that represents the server on which you just installed the NLS software.
- ◆ It modifies the AUTOEXEC.NCF file for the server on which you installed the NLS software to include a command to load the NLS.NLM file.

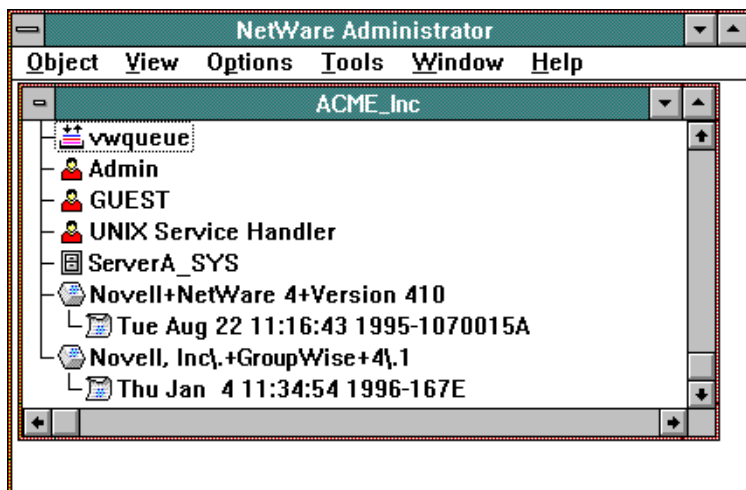
## Introducing NLS Manager

With NLS Manager, you can perform the following administrative tasks:

- ◆ Install a license certificate
- ◆ Create a metering certificate
- ◆ View licensing information on licensed products
- ◆ View license certificate details
- ◆ Assign users to license certificates
- ◆ View or change a license certificate's owner
- ◆ View LSP (License Service Provider) Server information

Figure 10-2 shows the browser window in NetWare Administrator with NLS-related objects visible.

Figure 10-2  
NLS Objects in the  
NetWare  
Administrator  
Browser



In Figure 10-2, notice that License Certificate objects are contained by Licensed Product container objects. For example, “Novell+NetWare 4+Version 410” is the licensed product, and “Tue Aug 22 11:16:43 1995-1070015A” indicates the license certificate.

## Installing Certificates

Two types of certificates are recognized by NLS:

- ◆ License certificates correspond to the printed license statement that is typically included in a software product’s packaging. The certificate is defined in such a way that use of the software is regulated according to the license agreement.

License certificates are created as objects in the Directory database. All License Certificate objects are installed into Licensed Product container objects. Licensed Product container objects are created automatically when you install a license certificate or create a metering certificate.

When adding license certificates to the Directory database, you should be aware of where in the Directory tree you want to install the license. This depends on who will use the license units associated with that license certificate.

For more information on the relationship between NLS and NDS, review “NLS and NDS: Considerations” on page 688.

- ◆ Metering certificates can be installed to enable you to proactively monitor the use of a software product.

When you create a metering certificate, you must use the exact Publisher Name, Product Name, and Version strings listed by the application you want to meter. Also, the application must include the ability to communicate with licensing services based on the standard LSAPI specification.

An LSAPI-enabled application communicates with a licensing service at startup time to indicate to the service that licensing resources are being used. By viewing a metering certificate's information, you can determine how many license units are currently being used.

NLS Manager provides a basic metering utility. For advanced software usage metering, you might want to evaluate other software metering utilities.

## Installing a License Certificate

When an NLS-aware application is installed, it should add a Licensed Product container object to the Directory and a License Certificate object to that container.

If additional license units for a licensed product are purchased, you might need to manually install an additional License Certificate object to the Licensed Product container.

### Procedure



1. **From the NetWare Administrator “Tools” menu, choose “Install License”; then choose “Install License Certificate File.”**
2. **In the “Install to Context” box, enter the Directory context where the certificate object should be installed.**

You can choose the Browse button next to the context box to locate the Directory context.

3. **In the “File Name” box, enter the license certificate filename.**

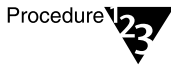
You can choose the Browse button next to the “File Name” box to locate the filename.

4. In the “Activation Password” box, enter the activation password for this license certificate, if necessary.
5. Choose “OK” to install the license certificate.

## Creating a Metering Certificate

To use NLS Manager as a basic software usage metering utility, you need to add a metering certificate to the Directory.

### Procedure



1. From the NetWare Administrator “Tools” menu, choose “Install License”; then choose “Create Metering Information.”
2. In the “Install to Context” box, enter the Directory context where the metering certificate object should be installed.

You can choose the Browse button next to the context box to locate the Directory context.

3. Enter the Publisher Name, Product Name, and Product Version in the appropriate boxes.

You must use the exact Publisher Name, Product Name, and Version strings listed by the application you want to meter.

4. Enter or select the correct number of license units for the certificate.
5. Choose “OK” to create the metering certificate.

# Managing Licenses

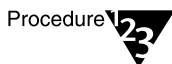
NLS license certificates are stored as objects in the Directory database. As such, they can be managed like other Directory objects. For more information about NLS and NDS, review “NLS and NDS: Considerations” on page 688.

NLS-related Directory objects are managed by the NLS Manager utility, which is incorporated into the NetWare Administrator utility. For more information about using NLS Manager, see “Introducing NLS Manager” on page 693.

## Viewing Licensed Product Information

When a licensed software product is installed and recognized by NetWare Licensing Services, a Licensed Product container object is added to the Directory database. Using NLS Manager, you can view information about a licensed product.

### Procedure



1. **From the NetWare Administrator “Browse” window, select a Licensed Product container object and click the right mouse button.**
2. **From the action menu, choose “Details.”**

From the “Product Information” page, you can find the following information:

- ◆ The number of license units available to all users assigned to certificates within that Licensed Product container
- ◆ The number of license units available to the current user (the Directory object you used to log in)
- ◆ The number of license units currently in use
- ◆ The number of license units currently installed

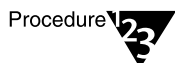
From the “Product Users” page, you can find a list of the users who are currently using licensing units available from the certificates contained by the Licensed Product container object.

## Viewing License Certificate Information

When a licensed software product is installed with NetWare Licensing Services, a License Certificate object is added to the Directory database. Also, at a later time, you can add license certificates to an existing Licensed Product container.

Using NLS Manager, you can view information about a license certificate.

### Procedure



1. **From the NetWare Administrator “Browse” window, select a License Certificate object and click the right mouse button.**
2. **From the action menu, choose “Details.”**

From the “Certificate Details” page, you can find the following information:

- ◆ The certificate’s License ID
- ◆ The number of license units available to all users assigned to that certificate
- ◆ The number of license units available to the current user (the Directory object you used to log in)
- ◆ The number of license units currently in use
- ◆ The number of license units currently installed

In the “Policy Information” list, you can find additional information about the license certificate, such as:

- ◆ The software publisher’s name
- ◆ The software product’s name
- ◆ The product version number
- ◆ The activation date (if any)
- ◆ The expiration date (if any)
- ◆ The certificate’s License ID
- ◆ Whether or not this certificate is metered by default



- ◆ Whether or not an assignment is required
- ◆ The time interval for updating the certificate
- ◆ Default consumption units (begins at 1)
- ◆ Other information specific to certificates in NetWare Licensing Services

From the “Product Users” window, you can find a list of the users who are currently using licensing units available from the License Certificate object.

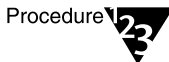
## Assigning Licenses to Users

You can assign a user, group, or container object to a license certificate with NetWare Licensing Services.



Only a certificate's owner can assign users access to the license units granted with the certificate.

### Procedure

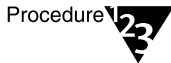


1. **From the NetWare Administrator “Browse” window, select the license certificate object you want to assign to a user or group and click the right mouse button.**
2. **From the action menu, choose “Details.”**
3. **Choose the “Certificate Assignments” button at the right of the window.**
4. **Choose the “Add” button.**
5. **Select an object to assign to this license certificate and choose “OK.”**

## Unassigning Licenses

You can unassign a user, group, or container object from a license certificate, when necessary.

### Procedure



1. From the NetWare Administrator “Browse” window, select the license certificate object you want to unassign a user or group from and click the right mouse button.
2. From the action menu, choose “Details.”
3. Choose the “Certificate Assignments” button at the right of the window.
4. Select the object for which you want to delete a license assignment and choose the “Delete” button.

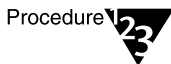
## Assigning a New Owner to a License Certificate

When a license certificate object is added to the Directory database, the object logged in to the Directory is assigned ownership of the license certificate. At some point, you might want to reassign ownership of a license certificate.



Only a certificate's owner can reassign ownership of the certificate.

### Procedure

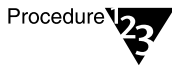


1. From the NetWare Administrator “Browse” window, select the License Certificate object that you want to view or change ownership of and click the right mouse button.
2. From the action menu, choose “Details.”
3. Choose the “Certificate Owner” button at the right of the window.
4. Choose the “Browse” button to search for another object to assign as owner of this certificate object.
5. Select the object you want to assign as owner of this certificate object and choose “OK.”

## Viewing LSP Server Information

When you register a License Service Provider (LSP) with NDS, an LSP Server object is added to the Directory database.

### Procedure



1. From the NetWare Administrator “Browse” window, select an LSP Server object icon.
2. From the action menu, choose “Details.”



# **A** *Troubleshooting the Network*

This appendix provides general hardware and network troubleshooting information for resolving equipment-related errors on a server running NetWare 4™ networking software.

## **Troubleshooting Hardware and Network Problems**

### **Identifying Problems After Installation**

If the problem occurred after installation, it may indicate that the network was installed incorrectly.

- ◆ Check all network boards for possible conflicting address and I/O settings.

Each component should be able to work as a standalone system. Remove all network boards in the server and boot DOS. Add each board one at a time and make sure that DOS still boots after each addition.

- ◆ Make sure that all cables are fastened securely to all network boards and network connectors, and that terminating resistors are installed correctly.

## Resolving Hard Disk Access Problems

To diagnose hard disk access problems, you should identify if the following conditions exist:

- ◆ The disk driver has not been loaded.
- ◆ A hard disk is not installed or cabled correctly.
- ◆ The communication channel between the controller interface board, the disk coprocessor board, and the hard disk is not functioning.
- ◆ The hard disk controller board is not terminated or addressed correctly.

To resolve hard disk access problems, you should perform the following actions:

- ◆ Make sure the disk driver is loaded. At the console, type `MODULES` to view the loaded disk drivers.
- ◆ Check the cables between the hard disks and the controller boards. Be sure Pin 1 of each cable is attached to Pin 1 of each connector.
- ◆ Check the power cables and make sure they are seated correctly in the power sockets on the hard disks.
- ◆ Check the jumper settings on the disk coprocessor board (DCB), the controller board, and the hard disk. Refer to the hardware documentation for correct jumper settings.
- ◆ If you are using a DCB, run `DISKSET` to make sure the hardware configurations contained on the EEPROM chip on the disk coprocessor board match those for the hard disks in your server.
- ◆ Load `INSTALL` to check the NetWare<sup>®</sup> disk partition and volume information on the hard disk. For details, see “Maintaining Volumes” on page 468.
- ◆ Make sure that each controller interface board connected to the same disk coprocessor board has its own valid address.

## Making Computer Memory Available for Network Drivers

To increase the amount of workstation memory available for network drivers:

- ◆ Add more memory.
- ◆ Unload unneeded TSR (terminate-and-stay-resident) programs (DOS clients only).
- ◆ Modify the NET.CFG file to load only necessary drivers.
- ◆ Modify the CONFIG.SYS file to load only necessary drivers.

For more information about freeing up memory on a workstation, see “Resolving Workstation Memory Problems” on page 741.

For information about freeing up memory on a server, see “Resolving Server Memory Problems” on page 714.

## Resolving Cabling Problems

- ◆ Use the proper cabling for your network topology as specified by IEEE. Make sure cable segments do not exceed the recommended lengths.
- ◆ Make sure cable segments are properly terminated for the type of cabling being used.
- ◆ Make sure terminators and in-line cable connectors are working properly.

If you are not sure whether a terminator or connector is working properly, replace it. If the new components work properly, discard the old ones.

- ◆ Make sure there are no breaks in the cable or shield. Use a time delay reflectometer (TDR), a LANalyzer, or a volt ohm meter (VOM) to test cabling for breaks in the cable conductor or shield.
- ◆ Make sure cabling is routed away from devices that produce high electric or magnetic fields, such as fluorescent lights, microwaves, radar, X-rays, copy machines, etc.

## Power Supply Errors

An inconsistent power source is the most common cause of hardware problems. It also produces the most devastating results.

Power outages cause workstations, network servers, print servers, and backup devices to reboot. When this happens, all information stored in RAM is lost, and sometimes hardware is damaged.

Power spikes and “brownouts” can also cause a variety of hardware errors.

You can have reliable network performance only if you plan for power outages and fluctuations and protect against them. The following tips can help you do this:

- ◆ Add a dedicated power feed and ground line from your breaker box to critical equipment. Make sure the ground line connects to earth ground.
- ◆ Install an uninterruptible power supply (UPS) or a standby power system (SPS) to provide power to critical equipment for 15 minutes after a power outage.

The capacity of such power supplies is limited, so you may not want to plug nonvital hardware (such as monitors or printers) into the UPS or SPS line.

- ◆ Train users to save data and log out of the network when the lights go out. Then you can bring down the NetWare server in an orderly fashion without forcing users off the system while the server is running on UPS or SPS power.
- ◆ Install a surge suppressor or power conditioner on all power lines that are used by computers. Many UPS and SPS devices already have this feature.
- ◆ Do not allow anyone to plug fans, printers, copy machines, vacuum cleaners, or other motor-driven appliances into the dedicated line or into any power line with computers.

Insert dummy plugs into open outlets to prevent people from plugging such appliances into computer power sources.



# Troubleshooting the NetWare Server

This section provides troubleshooting suggestions for typical NetWare® server problems such as abends, disk I/O errors, insufficient disk space, and insufficient memory.

## Resolving Abends

The NetWare 4 operating system is very resilient, but errors can and will arise. Serious problems are usually accompanied by abend (abnormal end) messages.

Abend messages are usually caused by consistency check errors or CPU-detected software errors.

Consistency check errors are internal tests placed in the NetWare operating system to ensure the stability and integrity of internal operating system data.

Consistency check errors might be caused by a corrupted operating system file, by corrupted or outdated drivers and NetWare Loadable Module™ (NLM™) programs, or by hardware failure.

## What Happens When You Get an Abend

When the server abends, it displays an abend message similar to the following:

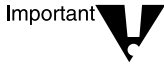
```
Abend: SERVER-4.10-message_number message_string  
ADDITIONAL INFORMATION: message
```

The “Additional Information” section states the probable cause of the abend. It indicates where the problem occurred and gives the name of any NLM program associated with the abend. This information helps you determine how to resolve the abend.

You can respond to the abend manually or have the server respond automatically.

When you respond manually, the server determines the nature of the abend and displays the appropriate response option on the screen, along with additional options for bringing down the server or executing a core dump. You must execute an option to respond to the abend.

When the server responds automatically, it executes the appropriate response without intervention.



Sometimes an abend (or a faulty NLM program) can cause the server console to “hang” (stop functioning). In this case, the abend message is not displayed and you cannot enter commands at the console prompt.

If this happens, press <Ctrl>+<Alt>+<Esc>. A message asks if you want to down the server. Enter “Y” to down the server and exit to DOS, or “N” to return to the console prompt.

## Responding to the Abend Manually

The default method of responding to an abend is “automatic.” For more information about automatic response to abends, see “Responding to the Abend Automatically” on page 711.

To respond manually to abends, change *either* of the following SET parameters to the values shown:

```
AUTO RESTART AFTER ABEND = 0
DEVELOPER OPTION = ON
```

When an abend occurs, the server displays a short list of options appropriate to the nature of the abend. To respond to the abend, you must execute one of the options by typing the first letter of the option.

The following options may be displayed. Note that several of the options have the same first letter (such as R, S, or X). In a given abend situation, the option list will include only one option for any given first letter.

- ◆ S=Suspend the running process, update ABEND.LOG, and attempt to down the server.

This option appears if the abend was “software-detected,” that is, detected by NetWare. It is important to save files, shut down the server, and try to solve the problem that caused the abend. Review the ABEND.LOG file to help determine the source of the problem.

When you execute this option, the server sends a message every two minutes to users advising them to save their files and log out. The server then stops the running process, updates the ABEND.LOG file, and attempts to shut down and restart the computer.

The amount of time before the server shuts down and restarts is determined by the SET parameter AUTO RESTART AFTER ABEND DELAY TIME. You can set this value from 2 to 60 minutes.

- ◆ R=Resume the running process, update ABEND.LOG, and attempt to down the server

This option appears if the abend was an NMI (nonmaskable interrupt), indicating a parity error or a machine check processor exception. It is important to save files, shut down the server, and solve the problem causing the abend. Review the ABEND.LOG file to help determine the source of the problem.

When you execute this option, the server sends a message every two minutes to users advising them to save their files and log out. The server then resumes the running process, updates the ABEND.LOG file, and attempts to shut down and restart the computer.

The amount of time before the server shuts down and restarts is determined by the SET parameter AUTO RESTART AFTER ABEND DELAY TIME. You can set this value from 2 to 60 minutes.

- ◆ S=Suspend the running process and update ABEND.LOG

This option appears if the abend was “hardware-detected,” that is, detected by the processor. All hardware-detected abends have the words “processor exception” in the abend message.

These abends include page faults, protection faults, and invalid op codes. When this option is available, the server has determined that it cannot return the process to a safe state, but that it does *not* need to shut down the computer immediately to resolve the problem. You may still need to shut down the computer and restart it at a later time.

When you execute this option, the server suspends the currently running process, updates the ABEND.LOG file, but does not shut down the computer. Server performance may be poor, because a loaded NLM is probably malfunctioning.

Read the “Additional Information” part of the abend message to learn which NLM might be causing the problem. Wait until a convenient time, then shut down the server and restart it. Examine the ABEND.LOG file for more information about the source of the problem.

- ◆ S=Return the running process to a safe state and update the ABEND.LOG file

Like the previous option, this option appears if the abend was “hardware-detected,” that is, detected by the processor. All hardware-detected abends have the words “processor exception” in the abend message.

These abends include page faults, protection faults, and invalid op codes. When this option is listed, the server has determined that it *can* return the process to a safe state.

When you execute this option, the server returns the running process to a safe state and updates the ABEND.LOG file, but it does *not* shut down the computer. In most cases, the machine completely recovers and no further action is necessary. This option resolves most page fault abends.

- ◆ Y=Copy diagnostic image to disk

Execute this option to perform a core dump that can be examined to determine the cause of an abend.

- ◆ X=Restart

This option appears only if DOS has been removed. Execute this option if you want to restart the server.



If DOS has been removed, the server will not create or update an ABEND.LOG file.

- ◆ X=Update ABEND.LOG and then exit

Execute this option if you want to bring down the server and exit to DOS. If you power off the server without first executing one of the S or R options to resolve the abend, the server will not update the ABEND.LOG file.

- ◆ Otherwise, power off and back on to restart

If the console has been secured, you must power off and then back on to restart the server. If you power off the server without first executing one of the S or R options to resolve the abend, the server will not update the ABEND.LOG file.



When the server restarts, it moves the ABEND.LOG file from the DOS partition to SYS:SYSTEM.

## Responding to the Abend Automatically

You can require the server to respond automatically to abends. Two automatic responses are possible.

- ◆ When both of the following parameters are set to the values shown, the server responds to the abend automatically by evaluating the source of the abend and executing the appropriate S or R option described in the previous section.

```
AUTO RESTART AFTER ABEND = 1  
DEVELOPER OPTION = OFF
```

Because these are the default values of the parameters, the default mode is to respond to abends automatically.

- ◆ When both of the following parameters are set to the value shown, the server responds to the abend by downing the server and attempting to restart it.

```
AUTO RESTART AFTER ABEND = 2  
DEVELOPER OPTION = OFF
```

Use the following parameter to specify how long the server waits after an abend before attempting to shut down and restart the computer:

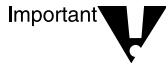
`AUTO RESTART AFTER ABEND DELAY TIME = minutes`

Use the SET command or the SERVMAN or MONITOR utilities to set the parameter values. See “SET,” “SERVMAN,” or “MONITOR” in *Utilities Reference*.

The DEVELOPER OPTION parameter is found in the “Miscellaneous” category of parameters.

The AUTO RESTART AFTER ABEND and AUTO RESTART AFTER ABEND DELAY TIME parameters are found in the “Error Handling” category.

All parameters can be set in the STARTUP.NCF file.



Because the server responds to the abend automatically, you may not know when an abend has occurred. Therefore, you should periodically check the ABEND.LOG file or the “Server Up Time” statistic on the “Connection Information” screen of MONITOR.

## Resolving Server I/O Errors

To resolve a general disk I/O error on the server, try one or more of the following remedies:

- ◆ Check the disk subsystems to make sure the power is on and the cables are correctly connected between the controller and the subsystems.
- ◆ Make sure the subsystem cables are terminated correctly.
- ◆ Make sure the disks are installed correctly.
- ◆ Make sure you have current NetWare 4-certified disk driver loaded. Many drivers can be found on the NetWare CD-ROM or on the master diskettes. Updated drivers may also be available from third-party disk driver manufacturers.

- ◆ Make sure the interrupt parameters, I/O port settings, slot settings, etc. for the driver match those for the hardware. Also, make sure custom parameters have been set correctly for your hardware.

- ◆ At the server console, type the following command:

`SCAN FOR NEW DEVICES <Enter>`

This causes the operating system to request controller information about all devices.

- ◆ Load `INSTALL`, select “Disk Options,” and then “Modify Disk Partitions and Hot Fix.” Make sure the device is visible and has a valid partition.

- ◆ Increase the Hot Fix™ Redirection Area, using `INSTALL.NLM`.

To change the Hot Fix Redirection Area on an existing drive, back up all the data on the partition, delete the volumes on the partition, and delete the partition; then re-create it.

Assign the partition a different percentage for the Hot Fix Redirection Area; then recreate the volumes and restore the data.

If you have tried all the preceding suggestions without success, contact your Novell® Authorized Reseller<sup>SM</sup> representative or drive manufacturer.

## Resolving Server Disk Space Problems

To resolve an insufficient disk space error, you should do one or more of the following:

- ◆ Delete unnecessary files and directories from the volume.
- ◆ Change the Minimum File Delete Wait Time `SET` parameter in your server’s `AUTOEXEC.NCF` file equal to 0 so that files can be purged immediately rather than being retained in a salvageable state on the volume.
- ◆ Use the `FILER` or NetWare Administrator utility to purge deleted files if they cannot be purged automatically. (The deleted files are using up directory table space.)

- ◆ Increase the volume size and/or add more disks to the volume.
- ◆ Increase the percentage of disk space that can be used by a directory.
- ◆ If the disk or volume has space available, check the disk drives and disk channel to see if a failure has occurred.
- ◆ Use SET to increase the percentage of disk space that can be used by a directory.
- ◆ Delete NLM programs that you no longer use.
- ◆ Check and adjust or remove any volume restrictions placed upon users.
- ◆ If the disk or volume has space available, check the disk drives and disk channel to see if a failure has occurred.

For information on SET parameters, see “Managing Server Hard Disks” on page 489 and “SET” in *Utilities Reference*.

## Resolving Server Memory Problems

To free up server memory temporarily (until you can add more memory to the server), do one or more of the following:

- ◆ Use the FILER or NetWare Administrator utility to purge deleted files on the specified directory that cannot be purged automatically. (Deleted files are using up directory table space.)
- ◆ Unload NLM programs, such as INSTALL or MONITOR, that are not currently needed.
- ◆ Dismount volumes that are not being used.
- ◆ Reduce the size or number of volumes that the server supports.
- ◆ Delete unused files and directories on the specified volume.
- ◆ Change the Minimum File Delete Wait Time SET parameter in the AUTOEXEC.NCF file so that files can be purged immediately rather than being retained in a salvageable state on the volume.



- ◆ As a last resort, back up all files in your volume, bring down your server, and use INSTALL to reinitialize the volume. Specify block size of 64 KB and turn the “Block Suballocation” option to “Off.”

(This setting uses a lot of disk space but increases the amount of memory available.)

For more information, see Chapter 7, “Maintaining the NetWare Server,” on page 401 and “SET” in *Utilities Reference*.

## Resolving Locked Device Errors

To resolve a locked device error, try one or more of the following:

- ◆ Wait for a while; the task in process may complete and free the device.
- ◆ Retry the action that resulted in the error.
- ◆ Load MONITOR.NLM, delete all user connections, and disable logins.
- ◆ For a disk device error, unload NLM programs (other than the device driver) that may be using the disk. Dismount all volumes on the disk.

If you have tried all of the above without success, contact your Novell Authorized Reseller representative or the drive manufacturer.

## Resolving File I/O Errors

To resolve a file I/O error, try one or more of the following:

- ◆ Check to see that the volume (especially volume SYS:) is mounted. To check volumes, type VOLUME at the server console prompt.
- ◆ If the volume is out of disk space, error messages will appear on the console screen indicating that the volume is almost out of disk space. Check the console screen.
- ◆ Type DIR at a DOS workstation to see how much space remains.

To increase the amount of free space, do one or more of the following:

- ◆ Delete extraneous files (if you can log in from a workstation).
- ◆ Type SET IMMEDIATE PURGE OF DELETED FILES = ON at the console prompt, and retry the action.
- ◆ If you have an additional disk, increase the size of the volume by creating an additional segment of the volume on the disk.

See also “Resolving Volume I/O Errors.”

## Resolving Volume I/O Errors

To resolve a volume I/O error, try one or more of the following:

- ◆ Make sure *all* devices that contain the volume are online. (Volumes may span multiple devices.) See “Resolving Server I/O Errors.”.
- ◆ Load and execute VREPAIR.
- ◆ Load INSTALL and select “Volume Options.” Make sure the volume is visible.

If you have tried all of the above without success, contact your Novell Authorized Reseller representative or disk drive manufacturer.

## Resolving Event Control Block Allocation Errors

Event control block allocation system messages can occur when you first bring up the server or after the server has been running for some time.

These messages indicate that the server was unable to acquire sufficient packet receive buffers, usually called *event control blocks* (ECBs). Running out of ECBs is not a fatal condition.

Servers that run for several days where high loads occur in peaks might exceed the set maximum number of ECBs, causing the system to generate ECB system messages.

If these situations are caused by *occasional* peaks in the memory demand, you should probably maintain your current maximum ECB allocation and allow the message to be generated at those times.

On the other hand, if your server memory load is very high and you receive frequent ECB allocation errors, you should probably set your maximum ECB allocation higher. Use the following SET command in the STARTUP.NCF file:

```
SET MAXIMUM PACKET RECEIVE BUFFERS=number
```



Memory allocated for ECBs cannot be used for other purposes.

The minimum number of buffers available for the server can also be set in the STARTUP.NCF file with the following command:

```
SET MINIMUM PACKET RECEIVE BUFFERS=number
```

## Resolving Server Console Command Problems

To diagnose server console command problems, you should identify whether the following conditions exist:

- ◆ Some SET parameters can only be set in the STARTUP.NCF file.
- ◆ You are not at the system console.
- ◆ The server has been brought down.
- ◆ The server has failed (“hung”).
- ◆ The SERVER.EXE file is corrupted.
- ◆ The NetWare operating system has been configured incorrectly.

To resolve server console command problems, you should perform the following actions:

- ◆ Type the SET parameter in the STARTUP.NCF file and then bring the server down and back up.
- ◆ Make sure all cables are fastened securely to all network boards and network connectors. Check that terminating resistors are installed correctly.
- ◆ From a backup, or from the *NetWare 4.11 Operating System* CD-ROM, copy a new version of SERVER.EXE to the server boot directory. Have all users close their files and log out.

Bring down the server, if possible. If not, wait a few minutes after all users have logged out; then reboot the server.

- ◆ Check your server worksheet in *Installation* for network board configurations. Then check the actual hardware configuration on each network board in the server to make sure the two match.

If your recorded network board configurations do not agree with the actual hardware configurations, reload the LAN driver with the correct parameters or change the hardware settings to match the LAN driver parameters.

- ◆ Check all network board settings for possible interrupt and I/O port conflicts. The server can boot up initially even if the interrupt on a network board is set incorrectly.

The most common conflict occurs when a network board is set to interrupt 4 and a printer is connected to the server's serial port, which also uses interrupt 4.

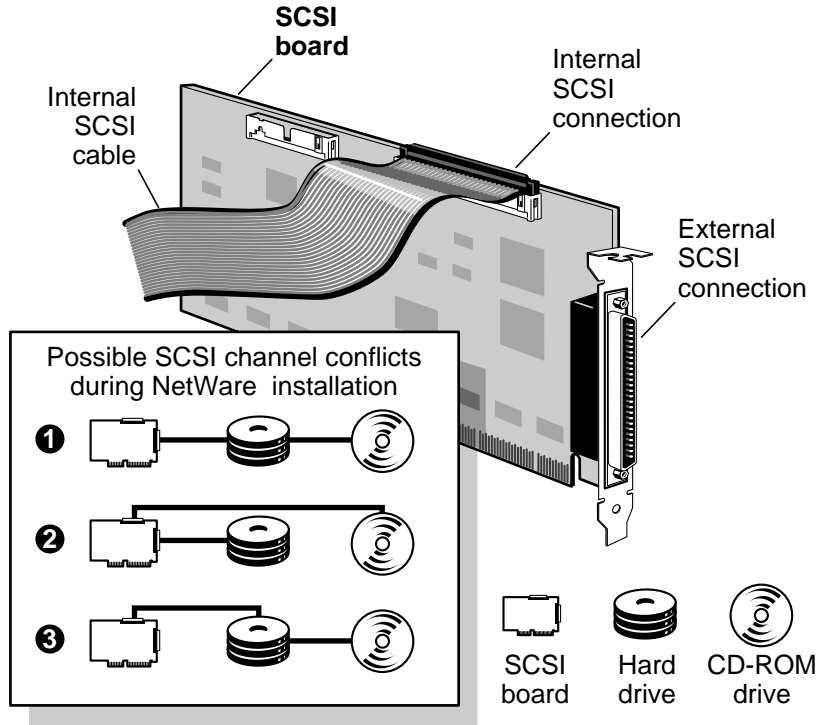
## Resolving Keyboard Locking Problems When Copying Files from CD-ROM

To diagnose keyboard locking problems when copying files from CD-ROM, you should identify if the following conditions exist:

If you have a CD-ROM device that shares a SCSI bus with a disk subsystem containing volumes to which NetWare installation files are copied (typically volume SYS:), your keyboard may lock up while loading drivers or copying files to the volume.

Figure A-1 shows possible configuration conflicts.

**Figure A-1  
SCSI Adapter  
Conflicts**



Remove the CD-ROM device drivers that you used to set up the CD-ROM drive as a DOS device from your CONFIG.SYS file. This will avoid possible conflicts when the *NetWare 4.11 Operating System* CD-ROM is mounted as a NetWare volume.

To resolve keyboard locking problems when copying files from CD-ROM, you should use the following procedure.

**Procedure**



1. Press <Alt>+<Esc> until you are at the console prompt (:).
2. Type  
DOWN <Enter>

**3. Then type**

```
EXIT <Enter>
```

**4. Using a text editor, remove the CD-ROM device drivers from your CONFIG.SYS file.**

**5. Save the updated CONFIG.SYS file.**

**6. Using a text editor, remove any references to the CD-ROM drivers from your AUTOEXEC.BAT file.**

**7. Save the updated AUTOEXEC.BAT file.**

**8. Reboot the server by pressing <Ctrl>+<Alt>+<Del>.**

**9. (Conditional) If the server doesn't boot automatically from the AUTOEXEC.BAT file, change to the subdirectory to the SERVER.EXE file (the default directory is C:\NWSERVER) and other boot files, and type**

```
CD \NWSERVER <Enter>
```

```
SERVER <Enter>
```

**10. (Conditional) If you are using ASPI device drivers (for example, for an Adaptec controller), you need to perform *one* of the following commands:**

```
LOAD AHA1540 <Enter>
```

or

```
LOAD ASPICD <Enter>
```

or

```
LOAD CDNASPI <Enter>
```

**11. At the console, type**

```
LOAD NWPA <Enter>
```

**12. At the console, type the following**

```
LOAD CDROM <Enter>  
CD MOUNT NW410 <Enter>
```

**13. At the console, type**

```
LOAD INSTALL <Enter>
```

## **Resolving Problems When Server “Hangs” After Mounting Last Volume**

To diagnose problems when the server hangs after mounting the last volume, you should identify whether the following conditions exist:

- ◆ The server network board is not initializing when the server is brought up because the board is not installed or seated correctly.
- ◆ The server network board is not configured correctly.

To resolve problems when the server hangs after mounting the last volume, you should perform the following actions or ensure that the following conditions exist:

- ◆ Run CONFIG at the server console to see what settings appear on the screen. Check the network board configurations of the boards in the server. Make sure the settings match.
- ◆ Make sure that all server and workstation network boards are seated properly and that cabling and connections are attached securely.
- ◆ Make sure that the terminators on cables have the right ohm rating and are installed correctly. The IBM\* PC Cluster sends a broadcast message during initialization and hangs if the network is not cabled or terminated properly.
- ◆ Check the network boards in all workstations for correct node address settings.

## Resolving Problem When No Volumes Mount

Volume SYS: is the backout volume for TTS™ (Transaction Tracking System™). Volume SYS: also contains the NetWare system files and the NLM programs.

If volume SYS: does not mount when the server is booted, then the AUTOEXEC.NCF file does not execute, LAN drivers do not load, TTS can't be enabled, and the volume does not become part of the Directory tree.

To diagnose problems when no volumes mount, you should identify if the following conditions exist:

- ◆ Volume SYS: is corrupted.
- ◆ The hard disk containing volume SYS: has failed.
- ◆ The cable or power to the external hard disks has malfunctioned.

To resolve problems when no volumes mount, you should perform the following actions:

- ◆ Run VREPAIR on volume SYS: (VREPAIR autoloads from the DOS partition).
- ◆ Check the cabling and power to the external hard disks. Replace any faulty components.
- ◆ Replace the hard disk containing volume SYS:.
  - ◆ Load INSTALL to create the partitions and volume SYS:.
  - ◆ Restore the data from a backup copy.

## Resolving Problems When Only Some Volumes Mount

To diagnose problems when only some volumes mount, you should identify whether the following conditions exist:

- ◆ The server does not have enough RAM.
- ◆ The disk driver for external drives may not be loaded.



To resolve problems when only some volumes mount, you should perform the following actions:

- ◆ Add more RAM.
- ◆ At the server console, type `MODULES` to see which drivers are loaded.

## Resolving Disk Error Problems When a Volume Is Mounting

To diagnose problems when disk errors occur while a volume is mounting, you should identify whether the following conditions exist:

- ◆ The server does not have enough memory to mount the volume.
- ◆ The operating system is experiencing directory sector mismatching. This mismatching can be caused if the media is defective or if the server is turned off without the `DOWN` command.

To resolve problems when disk errors while a volume is mounting, you should perform the following actions:

- ◆ Load `MONITOR` and check the status of the available cache buffers. If the cache buffers are fewer than 20%, add more memory to your server.
- ◆ Minor errors usually correct themselves through normal network use. For example, if a `FAT` entry is wrong, the entry is updated and corrected the next time it is written to. If errors do not correct themselves, run `VREPAIR`.
- ◆ Some problems may be corrected automatically by `TTS`.

## Resolving Memory Errors When a Volume Is Mounting

To diagnose problems when memory errors while a volume is mounting, you should identify whether the following conditions exist:

- ◆ Volumes take more memory to mount than they require after being mounted because the mounting process performs consistency checks (for example, the duplicate copies of all the tables are checked).
- ◆ Volumes and directory entries grow dynamically. Thus, if your server is using most of the RAM (file cache buffers are close to 20% of the memory) and you dismount a volume, you may not be able to remount the volume unless additional memory is available.
- ◆ Each additional name space support that you add to a volume increases the size of the FATs and DETs. Adding name space support can cause the tables to grow so large that the server does not have enough RAM to mount the volume.

To resolve problems when memory errors while a volume is mounting, you should perform the following actions or ensure that the following conditions exist:

- ◆ Load MONITOR and check the status of the available cache buffers. If the cache buffers are fewer than 20%, add more RAM to your server.
- ◆ Free up memory by unloading resources.
- ◆ Streamline the directory structure. Every subdirectory takes at least one directory block (by default, a 4KB block of memory). Thus, subdirectories with only one file require as much memory as directories with 32 files.

If you combine directories so that most directories have about 32 files, and then purge the deleted subdirectories and files, you will free up memory.

- ◆ Calculate how much memory you need and add memory to the server. View the current volume size with INSTALL. (See “Modifying the Size of a Volume” on page 482.)

See Appendix A, “Calculate RAM Requirements,” in *Installation* for a formula for estimating the total amount of server memory needed.

- ◆ For a more accurate assessment of available RAM, load MONITOR, select “Resource Utilization” from the “Available Options” menu, and view the “Cache Buffers” setting in the “Server Memory Statistics” screen.

If the percentage is below 20%, you should add more memory.

- ◆ Remove the recently added name space support.



This is a destructive step that destroys all the extended file information. Before taking this step, try to free up enough memory so that the volume mounts and you can back up the data.

Have all users log out, and then unload all modules except the volume’s disk drivers. Dismount any mounted volumes.

To remove the name space, load VREPAIR and choose the “Remove Name Space Support From The Volume” and “Write All Directory and FAT Entries Out to Disk” options. Then run VREPAIR on the volume that would not mount.

## Resolving Volume Mounting Problems Because of Corrupted Directory Entry Tables or File Allocation Tables

To diagnose problems when mismatches exist in the duplicate copies of the File Allocation Table (FAT) and Directory Entry Table (DET), you should identify whether the following conditions exist:

- ◆ A power failure has occurred and the server has not been brought down with the DOWN command.
- ◆ A hard disk fails.
- ◆ A disk channel error occurs.

- ◆ A volume is not dismounted with the DISMOUNT command.
- ◆ Directory information in cache is not completely written to disk.

To resolve problems when mismatches in the duplicate copies of the FAT and DET exist, you should perform the following actions:

- ◆ Run VREPAIR.
- ◆ Add a UPS system so that the server is brought down automatically when a power failure occurs.
- ◆ Replace faulty disks or controllers.
- ◆ If the volume resides on mirrored hard disks, use FILER to salvage the data on one of the drives.

Use INSTALL to unmirror the hard disks (select the hard disk you think is least reliable and delete it from the mirroring list). Then run VREPAIR on the volume and mount the volume.

If the volume still does not mount or the data shows some corruption, read the next suggestion before remirroring the hard disks.

- ◆ If the volume resides on mirrored hard disks, salvage the data on both hard disks.

Use INSTALL to unmirror the hard disks and to salvage the orphaned (Out Of Sync) hard disk as a new volume. Run VREPAIR on both the old and the new volumes.

Mount both volumes and compare the files. Use INSTALL to delete the volume that has the least useful information; rename the salvaged volume, if necessary. Then use INSTALL to remirror the hard disks.

## Resolving Volume Mounting Problems Because of Name Space Module

Once a volume has been configured to support more than the DOS naming convention, the name space loadable module must be loaded before the volume can be mounted.

To diagnose problems when a volume cannot mount because the name space module is not loaded, you should identify whether the following conditions exist:

- ◆ The command to load the name space module is not in the STARTUP.NCF file.
- ◆ The module to load the name space has not been copied to the boot directory of the server.

To resolve problems when a volume cannot mount because of the name space module is not loaded, you should perform the following actions:

- ◆ Load the name space module; then mount the volume. Copy the name space module to the server boot directory and add the load command to the STARTUP.NCF file. The module then loads automatically whenever the server is booted.
- ◆ Delete the name space configuration from the volume.  
This is a destructive step that destroys all of the extended file information.
- ◆ Back up all non-DOS files. Then load VREPAIR and choose the “Remove All Name Space Entries” and “Write Changes Immediately to Disk” options. Then run VREPAIR on the volume.



# Troubleshooting Communication Problems

Communication problems are related to network boards, LAN drivers, network performance, and server/workstation communications, as well as to internetwork communications.

## General Communication Problems

To diagnose general network communication problems, you should identify whether the following conditions exist:

- ◆ The server network board is not seated or configured correctly.
- ◆ The network board cable from the server is faulty.
- ◆ Cabling on the network is faulty.
- ◆ The connector closest to the server is faulty.
- ◆ The RX-Net™ active hub is off.
- ◆ The correct Ethernet frame type has not been specified. NetWare 4.11 defaults to frame type 802.2.
- ◆ The repeater is off or is nonfunctional.
- ◆ The cabling is not terminated properly.
- ◆ Volume SYS: is not mounted.
- ◆ ISA disk controller boards installed in EISA machines have not been configured.

To resolve general network communication problems, you should perform the following actions:

- ◆ Check all hubs and repeaters to make sure they are on.
- ◆ Check the cables for proper termination.
- ◆ Make sure the server network board is seated properly.

- ◆ Replace the server network board with a board that works correctly. Make sure the new board has the same jumper settings.
- ◆ Run VOLUMES at the server console. If volume SYS: is not mounted, mount it. The server does not broadcast to the network until volume SYS: is mounted.
- ◆ Run CONFIG at the server console to check the configuration of the network boards. Then bring down the server, turn off the power, and check the actual network board settings:
  - ◆ Make sure all settings agree with the settings used to load the driver. If you load the driver with an interrupt that conflicts with the board's setting, the network board cannot broadcast on the network.
  - ◆ Make sure the node address on the board is a legal address. (Addresses 0 and FFFFFFFF are reserved; do not use them.)
- ◆ Run CONFIG at the server console to make sure each network board has a LAN protocol bound to it. Network boards cannot broadcast without a protocol.
- ◆ Run NLIST at a workstation, if possible, to check node addresses. Each node address on the network should be unique. Sometimes you can find the problem by turning off all workstations and turning them on one at a time.
- ◆ Have a user log in to the network from a workstation. Load MONITOR and choose "Connection Information" from the "Available Options" menu.
 

If the "Active Connections" list shows the user's login name, the server is receiving and responding to the workstation's request.

If the workstation receives a "Server cannot be found" error, make sure the server and workstation are using the same frame type.
- ◆ Replace segments of cable and cabling connections until communication is restored.

## Resolving Server Boot Problems After a Network Board Is Installed

To diagnose server boot problems after a network board is installed, you should identify whether the following conditions exist:

- ◆ The network board is not attached properly to the cable.
- ◆ The hardware conflicts with other boards, the monitor board, or ports in the server.
- ◆ The network board is faulty.

To resolve server boot problems after a network board is installed, you should perform the following actions.

- ◆ Cable the network board to at least one workstation and check the termination.
- ◆ Make a list of all I/O ports, interrupts, and memory addresses used by the equipment.

Also do the following to identify potential conflicts:

- ◆ Check the documentation that came with the computer and all installed hardware components.
- ◆ Make sure no two pieces of hardware are using the same I/O port, interrupt, or memory address.
- ◆ Make sure that the memory range for the I/O ports and memory addresses do not overlap. If there are conflicts, reconfigure the equipment so that no conflicts exist.



## Resolving Problems When Workstations Can't Communicate with a Server

To diagnose problems when workstations cannot communicate with a server, you should identify whether the following conditions exist:

- ◆ The server's network board is not initializing when the server is brought up because the board is not configured correctly or it has failed.
- ◆ The server is anticipating the wrong frame type. NetWare 4.1x uses Ethernet 802.2 as the default frame type for Ethernet LAN drivers that were loaded at the system console. Workstations running earlier versions of NetWare may be using Ethernet 802.3.
- ◆ Address or interrupt conflicts exist between two boards inside the server or between a board and the computer's hardware.
- ◆ The server does not have enough packet receive buffers.
- ◆ A protocol (such as IPX™) is not bound to the network board.
- ◆ The cabling is too close to sources of interference.
- ◆ Volume SYS: is not mounted.

To resolve problems when workstations cannot communicate with a server, you should perform the following actions.

- ◆ Make sure all network connectors (including transceivers and repeaters) are installed and the cable is attached securely.
- ◆ Make sure all network boards are seated firmly and the cabling connections are in place.
- ◆ Make sure the network cable is terminated properly. Many network boards send a broadcast message during initialization and will hang if the network is not cabled or terminated properly.
- ◆ Check cabling for interference from fluorescent lights, microwaves, radar, X rays, and copy machines. Either move the cable or shield it from the source of interference.

- ◆ Run VOLUMES at the server console to ensure that volume SYS: is mounted. Volume SYS: must be mounted before the server can advertise its name to the network.
- ◆ Run CONFIG at the server console to see what settings appear on the screen. Then check network board configurations in the server. Be sure the network board configurations match the settings that appear when you run CONFIG.
- ◆ Check the workstation frame types to see that they match those of the server.
- ◆ Check node address settings on all server and workstation network boards. Each address should be unique.
- ◆ Check all IPX internal and external network numbers. Each server and cabling system should have a unique IPX external network number.
- ◆ Make sure no two boards in the server are using the same I/O port, memory address, or interrupt.
- ◆ Bind the LAN driver (TRXNET, NE1000™, TOKEN, etc.) to IPX (or another communication protocol).
- ◆ If you have a lot of network traffic, increase the maximum number of packet receive buffers. (See “SET” in *Utilities Reference*.)

## Resolving Communication Problems Between Servers

To diagnose communication problems between servers, you should identify whether the following conditions exist:

- ◆ The hardware settings in the server are incorrect.
- ◆ The IPX internal/external network numbers conflict.
- ◆ The Novell Directory database is corrupted.
- ◆ Frame types are different.
- ◆ The router is filtering out the IPX external network number.

To resolve communication problems between servers, you should perform the following actions:

- ◆ Run CONFIG at the server console to see what settings appear on the screen. Then check network board configurations in the server. Be sure the network board configurations match the settings that appear when you run CONFIG.
- ◆ Check the IPX internal network number for the server and the IPX external network number for the cabling.

When multiple servers share the same cabling system (called a multiserver network), all servers must have the same IPX external network number. However, the servers must have unique IPX internal network numbers and unique node numbers.

When network cabling systems are connected through routers (internal or external), each cabling system must have a unique IPX external network number. NetWare 4 servers must also have a unique IPX internal network number apart from the cabling.

The unique IPX external network number is the first item read in a packet sending/receiving interaction.

- ◆ Reset the router with the RESET ROUTER console command.
- ◆ Check the cabling system for faulty termination.
- ◆ Bring down all servers except one. Reset its router with RESET ROUTER. Bring up each server, one at a time, establishing communications with it before bringing up the next one. Run DISPLAY NETWORKS to check for duplicate IPX external network numbers as each server is booted.
- ◆ Run DSREPAIR.
- ◆ Load FILTCFG.NLM at each server and verify that SAP traffic is being routed.

## Resolving Slow Server Response

To diagnose slow server response problems, you should identify whether the following conditions exist:

- ◆ The workstation network board is slow or faulty.
- ◆ Network cabling is faulty.
- ◆ The server network board is slow or faulty.
- ◆ Too many users are using the network.
- ◆ The server speed is not set to the highest speed.
- ◆ The server hard disk is slow or faulty.
- ◆ The server is low on memory.
- ◆ The volume has too many deleted files that have not been purged.
- ◆ Network traffic is extremely high.
- ◆ The cabling system is experiencing too much interference.
- ◆ A hard disk has failed or is failing.
- ◆ Insufficient directory buffers, cache buffers, or packet receive buffers have been allocated.
- ◆ An EISA controller board needs to be configured to use interrupts.

To resolve slow server response problems, you should perform the following actions.

- ◆ Check the computer's documentation for switch information. Set the CPU speed to its highest setting. Use SPEED to verify that the CPU is running at the appropriate speed.
- ◆ If a workstation or the server seems slow, insert a new network board into the slow computer to check performance. If the speed is still below normal, reinstall the original network board and replace the cable attaching the workstation or server to the network.

- ◆ Load MONITOR to check the status of packet receive buffers and service processes. Compare their values to the maximum allowable value.

Use SET to increase the values for the following parameters if your system is at the maximum value: Maximum Service Processes and Maximum Packet Receive Buffers.

(For additional ideas, see “Assessing Server RAM” on page 439.)

- ◆ Load MONITOR and check the Hot Fix™ status of all hard disks. Verify that all mirrored disks are still mirrored.
- ◆ Run the FILER text utility or the NetWare Administrator graphical utility to purge deleted files. Or set the “Purge” attribute on files you want to be purged immediately after being deleted.

For more information, see Chapter 2, “Managing Directories, Files, and Applications,” on page 97.

- ◆ Load MONITOR and check the LAN driver statistics. If you have more than one network board, compare the boards’ “Total Packets Sent” statistics. If one board is receiving most of the traffic, recable the network so that the boards have equal loads.
- ◆ If you are on a multiserver network or an internetwork, recable the system with a backbone to reduce network traffic. See “Network backbone” in *Concepts* for a description of a backbone.
- ◆ Check the cabling for interference from fluorescent lights, microwaves, radar, X rays, and copy machines. Either move the cable or shield it from the source of interference.

## Resolving Periodic Loss of Connection

To diagnose periodic loss of connection problems, you should identify whether the following conditions exist:

- ◆ A network board in either the server or a workstation is faulty.
- ◆ A user on the network is using an old NetWare shell file (for example, NETX.COM).

- ◆ Two workstations have the same node number.
- ◆ The cabling system is not terminated properly.

To resolve periodic loss of connection problems, you should perform the following actions.

- ◆ Run NLIST to make sure all node numbers are unique. At a DOS workstation, type

```
NLIST USER /A <Enter>
```

- ◆ Check all boot files. Make sure all users are using the latest version of the workstation software.
- ◆ Check the cabling for improper termination, loose connections, and faulty components.
- ◆ Use a LAN analyzer product to check the network boards, cables, and packets. (NetWare Care™ and LANalyzer® products are available from your Novell Authorized Reseller<sup>CLM</sup> representative.) Replace faulty boards and cables.
- ◆ Refer to your network hardware's documentation to review the cabling specifications for your cabling system. Make sure your system is in compliance with all the specifications.
- ◆ Set the console to display all workstation connections cleared by the watchdog. (See "SET" in *Utilities Reference*.)

If workstations are being cleared by the watchdog, check all network boards and the entire cabling system between the workstations and the server. Check for faulty cables, improper termination, and faulty hubs.

## Resolving ARCnet-Specific Software Problems

To diagnose ARCnet-specific software problems, you should identify whether the following conditions exist:

- ◆ The LAN driver being used is not specifically designed for the ARCnet\* network board.
- ◆ The LAN driver is outdated.

- ◆ Receive buffer sizes conflict.
- ◆ Node numbers are illegal or conflicting.
- ◆ The monitor board settings conflict with the network board settings.

To resolve ARCnet-specific software problems, you should perform the following actions.

- ◆ Load the LAN driver that matches the network board installed.
- ◆ Contact the vendor for an updated version of the LAN driver.
- ◆ Run NLIST. Make sure that all client workstation addresses are unique and that no station uses address 0. At a DOS workstation, type

```
NLIST USER /A <Enter>
```

- ◆ If the monitor is blank when the network board is in the workstation, the monitor could be using interrupt 2. Try setting the network board to an option that does not use interrupt 2; then edit the NET.CFG file to reconfigure the workstation's IPXODI.COM file.

(See the hardware documentation for a list of supported options for your board.)

## Resolving ARCnet-Specific Hardware Problems

To diagnose ARCnet-specific hardware problems, you should identify whether the following conditions exist:

- ◆ The passive or active hubs are faulty.
- ◆ The network boards are faulty.
- ◆ Improper cable lengths are connected to passive or active hubs.
- ◆ Two passive hubs are connected together.
- ◆ A passive hub is terminated improperly.

To resolve ARCnet-specific hardware problems, you should perform the following actions.

- ◆ Check the fuses in all active hubs. Replace faulty fuses.
- ◆ If active hub lights blink, bad packets are being sent on the network. Check for conflicting node addresses, bad network boards, and improperly terminated passive hubs.
- ◆ Check all passive hubs for proper termination.
- ◆ Check the lengths of the cables connecting active and passive hubs to make sure they are within specifications. (See the hardware documentation to review the cabling specifications for your network board.)
- ◆ Check the cabling system for loopbacks, such as a cable from an active hub that attaches back to the active hub rather than to a workstation. Make sure that two passive hubs are not cabled to each other.

## **Resolving Ethernet-Specific Software Problems**

To diagnose Ethernet-specific software problems, you should identify whether the following conditions exist:

- ◆ The workstation and the server are using two different Ethernet frame types.
- ◆ The monitor board settings conflict with the network board settings.



To resolve Ethernet-specific software problems, you should perform the following actions.

- ◆ Make sure that the server LAN drivers and the workstation LAN drivers have been configured for the same Ethernet frame type. (See “Frame” in *Concepts* for information on frame types.) Configure the workstations for the appropriate frame type.
  - ◆ For instructions on configuring workstation LAN drivers, see *NetWare Client for DOS and Windows User Guide*.
  - ◆ See “LOAD” in *Utilities Reference* for the parameter you need to configure the Ethernet LAN driver in the NetWare server.
- ◆ Some VGA boards use interrupt 2. If the monitor is blank when the network board is installed, set the network board to an option that does not use interrupt 2; then edit the NET.CFG file to reconfigure the workstation software.

(See the appropriate hardware documentation for a list of supported options for your network board.)
- ◆ For workstation LAN drivers or specialized software that set the node address for the client workstation’s network board, run NLIST to make sure that each network board has a unique node number. At a DOS workstation, type

```
NLIST USER /A <Enter>
```

## Resolving Ethernet-Specific Hardware Problems

To diagnose Ethernet-specific hardware problems, you should identify whether the following conditions exist:

- ◆ T-connectors are not terminated properly.
- ◆ The network board is set up for one type of cabling, but it is connected to a different type (such as thick Ethernet instead of thin Ethernet).
- ◆ Hardware conflicts exist between the workstation and the network board.

To resolve Ethernet-specific hardware problems, you should perform the following actions.

- ◆ Check for faulty termination. Each T-connector that has only one cable attached to it must be terminated. Each trunk must be terminated with a grounded terminator.
- ◆ Check the network boards. Make sure that the board is set for the type of cabling (thick or thin Ethernet) you are using.
- ◆ Check terminators with an ohmmeter for a resistance of 48 to 52 ohms. Replace any terminators that do not fall within the specified range.

## Resolving Token Ring-Specific Software Problems

To diagnose token ring-specific software problems, you should identify whether the following conditions exist:

- ◆ IBM LAN Support has not been loaded at the workstations.
- ◆ The LAN driver software is not loaded.

To resolve token ring-specific software problems, you should perform the following actions.

- ◆ Check for duplicate client workstation addresses if you have used DOS ODI™ drivers or specialized software to set the node addresses.
- ◆ Run DXMAID at each workstation, and set LAN Support to load automatically when the workstation is booted. The DXMAID program is on the *IBM LAN Support Program* diskette.

## Resolving Token Ring-Specific Hardware Problems

To diagnose token ring-specific hardware problems, you should identify whether the following conditions exist:

- ◆ A MAU (Multistation Access Unit) is faulty or has been set improperly.
- ◆ A faulty token ring adapter has been installed in a workstation or server.

To resolve token ring-specific hardware problems, you should perform the following actions.

- ◆ Reset the MAU.
- ◆ Check the MAU for faulty fuses, power problems, and bad ports.
- ◆ Check for faulty token ring adapters by running the DXMAID program found on the IBM *LAN Support Program* diskette.
- ◆ Check for breaks in the daisy-chained MAUs.

## Troubleshooting Workstations

This section provides troubleshooting suggestions for typical NetWare® client (workstation) problems, including ways to resolve workstation memory problems. This section also lists common NetWare workstation error messages (the 900 series of messages).

### Resolving Workstation Memory Problems

#### DOS Workstations

To free up DOS workstation memory temporarily (until you can add more memory to the workstation), do one or more of the following.

- ◆ Unload any unneeded TSR (terminate-and-stay-resident) programs.
- ◆ Optimize memory usage by loading DOS and other programs into high memory.

- ◆ Modify the CONFIG.SYS file to reduce the number of files that can be open at the same time, the number of buffers allocated for disk drives, and the memory size allocated by the shell for the DOS environment (the /E option).

The following settings are sufficient for normal workstation operation, but the values can be reduced further until problems occur:

```
FILES=20  
BUFFERS=20  
SHELL=C:\COMMAND.COM /E:640 /P
```

Be sure to reboot the machine after modifying the CONFIG.SYS file.

## OS/2 Workstations

Check the CONFIG.SYS file to see if there are any devices that can be unloaded; then try to load the driver again.

(For more information about the CONFIG.SYS file, see *NetWare Client for OS/2 User Guide*.)

## Resolving Workstation Disk Space Problems

To resolve an insufficient disk space error, do one or both of the following:

- ◆ Delete unnecessary files and directories from the volume.
- ◆ Unload TSR (terminate-and-stay-resident) programs that have swap files on the hard disk.

## *appendix* **B** *Managing NetWare Server for OS/2*

### **NetWare Server for OS/2 and NetWare 4**

Use NetWare<sup>®</sup> Server for OS/2\* like any other NetWare 4<sup>™</sup> server, with a few exceptions:

- ◆ The server is loaded using NWOS2.EXE instead of SERVER.EXE.
- ◆ Different keystrokes are used for navigating through server screens.
- ◆ DOMAIN.NLM is not supported and will not load.
- ◆ The PMMON utility is available in addition to MONITOR for monitoring the server.

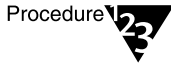
This appendix provides an explanation of these differences.

# Loading NetWare Server for OS/2

Load NetWare Server for OS/2 using NWOS2.EXE instead of SERVER.EXE.

## Using NWOS2.EXE to Load the Server from the Command Line

### Procedure



1. **Open an OS/2 full screen or OS/2 window session.**
2. **Change to the directory where the server files are installed.**

If you used the defaults during the installation, the directory is \NWSERVER and is located on your OS/2 boot drive. If you did not use the defaults, the directory has the name and location you assigned to it.

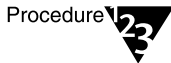
3. **At the command prompt, type**

```
NWOS2 <Enter>
```

NetWare Server for OS/2 loads in the full screen or window session you opened.

## Using the OS/2 Graphical Interface to Load the Server

### Procedure



1. **Choose the “Novell” group icon on your desktop.**

The “Novell” group icon was created when you installed NetWare Server for OS/2 or NetWare Client for OS/2.

2. **Choose the “NetWare Server for OS/2” icon.**

By default, NetWare Server for OS/2 loads in a full screen session. NetWare Server for OS/2 can be loaded in an OS/2 window by using the OS/2 “Settings” feature on the “NetWare Server for OS/2” icon.

For more information about the “Settings” feature, see your OS/2 documentation.

# Navigating in NetWare Server for OS/2

Use the following key sequences for accessing screens and menus in NetWare Server for OS/2:

Task	NetWare Server for OS/2 Key Sequence
Switching between screens	<Alt>+<N>
Accessing selection menu	<Ctrl>+<N>

If you release the <Alt> key too quickly (without pressing another key), you will activate the OS/2 system menu for the window session rather than the next NetWare screen.

## Using Loadable Modules in NetWare Server for OS/2

All NetWare Loadable Module™ (NLM) programs and console utilities work with NetWare Server for OS/2 the same as they do on any NetWare 4 server except for the following:

- ◆ **DOMAIN.NLM.** This NLM™ does not work with NetWare Server for OS/2 and cannot be loaded. Memory management is handled by OS/2.
- ◆ **NPRINTER.EXE.** If your computer is running NetWare Server for OS/2 and NetWare Client for OS/2, we recommend that you use NPRINTER.NLM rather than NPRINTER.EXE for printing. NPRINTER.EXE will work, but NPRINTER.NLM will work better for you. Don't load NPRINTER.NLM and NPRINTER.EXE on a computer that is running both the client and server.
- ◆ **VGADISP.NLM.** This NLM is used to display Japanese characters on a monitor screen. VGADISP.NLM does not work on NetWare Server for OS/2 and should not be loaded. OS/2 will take care of Japanese characters.

# Monitoring NetWare Server for OS/2

To monitor NetWare Server for OS/2, you can use MONITOR or PMMON. (PMMON is a monitoring utility that runs under the OS/2 Presentation Manager.)



Note

Although MONITOR works with NetWare Server for OS/2, the server utilization information is not correct. For a more accurate report of server utilization, use PMMON.

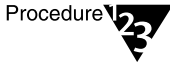
An icon for PMMON is placed in the “Novell” group icon on the desktop when you install NetWare Server for OS/2.

## Loading PMMON

PMMON can be loaded either by choosing the “PMMON” icon or by entering the command at the command line.

## Using the OS/2 Desktop

### Procedure



Procedure

1. **Choose the “Novell” group icon.**

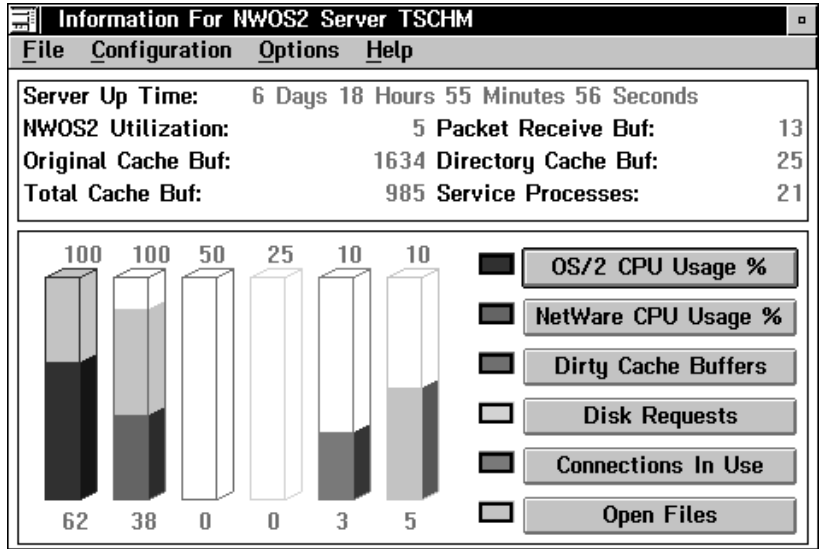
This opens the Novell Icon View.

2. **Choose the “PMMON” icon.**

The PMMON screen appears (see Figure B-1).

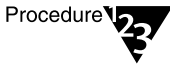


Figure B-1  
**PMMON Graphical  
 Server Monitor**



## Using the Command Line

### Procedure



1. **Open an OS/2 full screen or OS/2 window session.**
2. **Change to the directory where the server files from the NetWare Server for OS/2 installation are installed.**

If you used the defaults during the installation, the directory is \NWSERVER and is located on your OS/2 boot drive. If you did not use the defaults, the directory has the name and location you assigned to it.

3. **Type**

**PMMON** <Enter>

The PMMON screen appears.

# Using PMMON

PMMON includes pull-down menus that can be used to set memory sharing options, set performance tuning, free base server memory, access online help, and close the utility.

The following statistics are gathered and displayed in PMMON:

- NetWare Server for OS/2 utilization
- Original cache buffers
- Total cache buffers
- Packet receive buffers
- Directory cache buffers
- Service processes
- The percent of OS/2 CPU usage
- The percent of NetWare CPU usage
- Dirty cache buffers
- Connections in use
- Open files

There are six buttons on the right side of the PMMON screen. These buttons are used to set values and “watermarks” for the bar graphs at the bottom of the utility. For more information about each button, see the online help.

PMMON tracks many of the same statistics as MONITOR, but there is approximately a 5-percent performance loss when PMMON is running instead of MONITOR.



MONITOR does not correctly account for sharing the server with OS/2. For example, in MONITOR the server use may constantly read 100 percent even though the server is not busy.

## Setting Performance Tuning

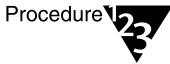
You can use PMMON to set the performance tuning level for NetWare Server for OS/2.

Setting the performance tuning level allows you to specify how much processing time is allocated to NetWare. The higher the performance tuning level, the more processing time is allocated to the server.

Whatever processing time is not allocated to NetWare Server for OS/2 is used by OS/2.

The default setting should work fine for your needs. However, you may want to lower the performance tuning level if OS/2 operation is too slow because of the amount of traffic on the server.

### Procedure



1. **Choose “Performance Tuning” from the “Configuration” menu.**

This activates a submenu listing 10 levels of performance tuning.

2. **Choose the level you want for your server.**

The performance tuning default level is 5. Changing the level in PMMON overrides the default while the server is running.

If the server is brought down, the default performance tuning level will return to 5 when the server is brought back up (unless you have another level set in the NET.CFG file).

Performance tuning can also be set in the NET.CFG file. (See “Performance Tuning” on page 759.)

## Setting Memory Sharing

You can use PMMON to set manual and automatic memory sharing options for NetWare Server for OS/2 and OS/2.

- ◆ Manual memory sharing allows you to allocate more or less memory to NetWare Server for OS/2 or OS/2 while the server is running. You determine the amount of memory each operating system needs.

For example, if the NetWare® operating system is used significantly more on your computer than OS/2, you would allocate more memory to NetWare Server for OS/2.

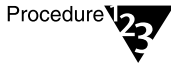
- ◆ Automatic memory sharing determines the proper amounts of memory NetWare Server for OS/2 or OS/2 will need as the server is running.

## Manual Memory Sharing

Use the “Memory Sharing” dialog box to allocate memory manually to NetWare Server for OS/2 or to OS/2.

The allocation changes you make in the “Memory Sharing” dialog box will override any memory settings in the NET.CFG file while the server is running. When the server is brought down and back up, the memory settings in the NET.CFG file will again take effect.

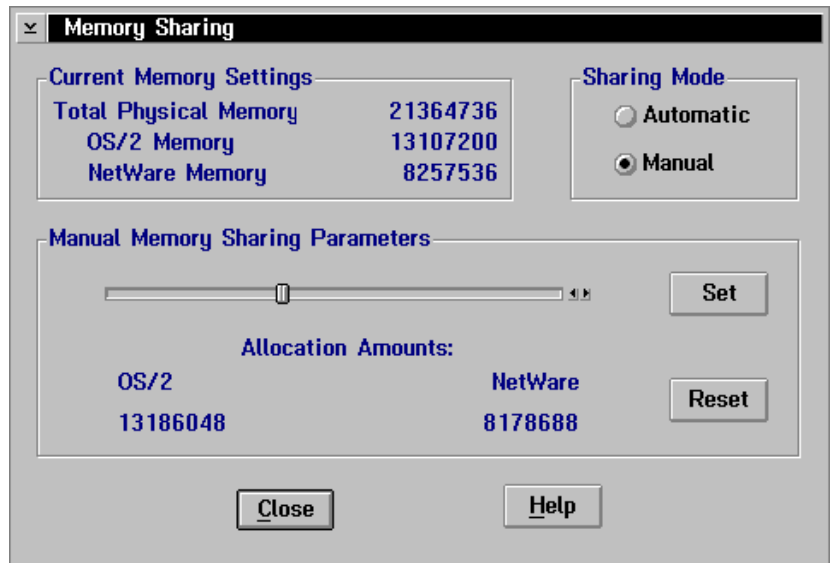
### Procedure



1. **Load PMMON.**
2. **Choose “Memory Sharing” from the “Configuration” menu.”**

The “Memory Sharing” dialog box appears (see Figure B-2).

Figure B-2  
“Memory Sharing”  
Dialog Box



This box displays the current memory settings and the amount of memory used by NetWare Server for OS/2 and OS/2.

3. **Click on the slider and move the mouse to the left or right until you get the allocation ratio you want.**

The amount of memory allocated to NetWare Server for OS/2 and to OS/2 changes as indicated in the “Allocation Amounts” field of the “Memory Sharing” dialog box.



You can also click on the left and right arrow buttons next to the slider to change memory settings.

4. **Choose “Set.”**

The changes you make to memory allocation do not take effect until the “Set” button is selected.

Choosing “Reset” switches the memory allocation to the amount of memory that the server had when you opened the “Memory Sharing” dialog box.

5. **Choose “Close” to close the “Memory Sharing” dialog box.**

## Automatic Memory Sharing

Automatic memory sharing is active as a default. Automatic memory sharing can be deactivated in the “Memory Sharing” dialog box or in the NET.CFG file.

To deactivate automatic memory sharing, choose “Manual” in the “Memory Sharing” dialog box.

To deactivate automatic memory sharing in the NET.CFG file, enter the following lines in the NET.CFG file:

```
NETWARE FOR OS/2
    AUTOMATIC MEMORY SHARING OFF
```

If you deactivate automatic memory sharing from the “Memory Sharing” dialog box, that setting overrides the default ON setting in the NET.CFG file while the server is running. If the server is brought down and back up, the setting in the NET.CFG file again takes effect.

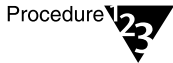
For more information about setting automatic memory sharing in the NET.CFG file, see “Automatic Memory Sharing” on page 762.

## Freeing Base Server Memory

You can use PMMON to free the base server memory that NetWare Server for OS/2 allocates from OS/2. The memory is released back to OS/2 when the server is brought down.

You can also free the server memory by using the REMOVE BASE SERVER MEMORY option in the NET.CFG file (see “Remove Base Server Memory” on page 762).

### Procedure



1. **Load PMMON.**
2. **Choose “Free Base Server Memory” from the “Configuration” menu.**

When “Free Base Server Memory” is active, a check mark appears next to it on the menu. To deactivate it, choose “Free Base Server Memory” again from the menu and the check mark will disappear.

## Releasing Server Memory

You can use PMMON to release the base server memory immediately back to OS/2 if the server is not running.

For example, if BASE SERVER MEMORY in your NET.CFG file is set at 8, OS/2 will allocate an 8 MB block of memory to NetWare Server for OS/2 when the computer boots. If you do not run the server, OS/2 will not be able to use that 8 MB block of memory because it is reserved for NetWare Server for OS/2.

If you want OS/2 to be able to use this memory when the server is not running, use PMMON to release it.



## Procedure

- 1. Load PMMON when the server is not running.**  
A message will appear indicating that the server is down.
- 2. Choose “Cancel” to cancel the message from the screen.**  
Do not choose “OK” to close the message because that will close PMMON.
- 3. Choose “Release Server Memory” from the “Options” menu.**  
A message appears that reads, “If you select OK, memory for the server will be given to OS/2.”
- 4. Choose “OK” in the message box to release the memory back to OS/2.**

## Supporting Workstations

NetWare Server for OS/2 supports all NetWare<sup>®</sup> clients.

If you are using the OS/2 High Performance File System (HPFS), you need to load the OS/2 and Macintosh name spaces in order for the server to support OS/2 and Macintosh clients. For information about loading name spaces, see “Setting Up a Volume to Store Non-DOS Files” on page 475.

If you run Extended Attributes on your OS/2 workstation, enter the following SET parameters at the server console:

```
SET maximum Extended Attributes per file or path = 32
SET maximum percent of volume space allowed for
  Extended Attributes = 10
```

For information about SET parameters, see “SET” in *Utilities Reference*.

# Configuring NetWare Server for OS/2

This section contains instructions for changing the configuration of NetWare Server for OS/2 using the NET.CFG file. It also includes an alphabetical listing of the options used for NetWare Server for OS/2 in the NET.CFG file.

The information in this section is also found in the configuration help screens in the NetWare Server for OS/2 installation program.

You may want to change the configuration of NetWare Server for OS/2 for any of the following reasons:

- ◆ To allow NetWare Server for OS/2 and NetWare Client for OS/2 to use the same network board
- ◆ To allocate a specific amount of memory to NetWare Server for OS/2
- ◆ To remove the memory that NetWare Server for OS/2 has allocated from OS/2 when the server is brought down
- ◆ To specify the proportion of processing time allocated to NetWare Server for OS/2
- ◆ To activate or deactivate automatic memory sharing between NetWare Server for OS/2 and OS/2

## NET.CFG File Format

Modify the NetWare<sup>®</sup> Server for OS/2 configuration by entering options and settings in the NET.CFG file.

The NET.CFG file contains options and settings that define how NetWare Server for OS/2 and NetWare Client for OS/2 will function on the network.

Each NET.CFG option has settings. If you use the NetWare Server for OS/2 installation program to modify the NET.CFG file, these settings are alphabetized under the option to which they apply in the "NET.CFG Options" window.



If you use an OS/2 text editor to modify NET.CFG, see “NET.CFG Options Reference” in *NetWare Client for OS/2 User Guide* for more about each option and setting.

## Conventions for Entering NET.CFG Options

You can create or edit the NET.CFG file through the NetWare Server for OS/2 installation program or by using an OS/2 text editor.

Use the following rules to create or modify the NET.CFG file. These rules are illustrated in Figure B-3.

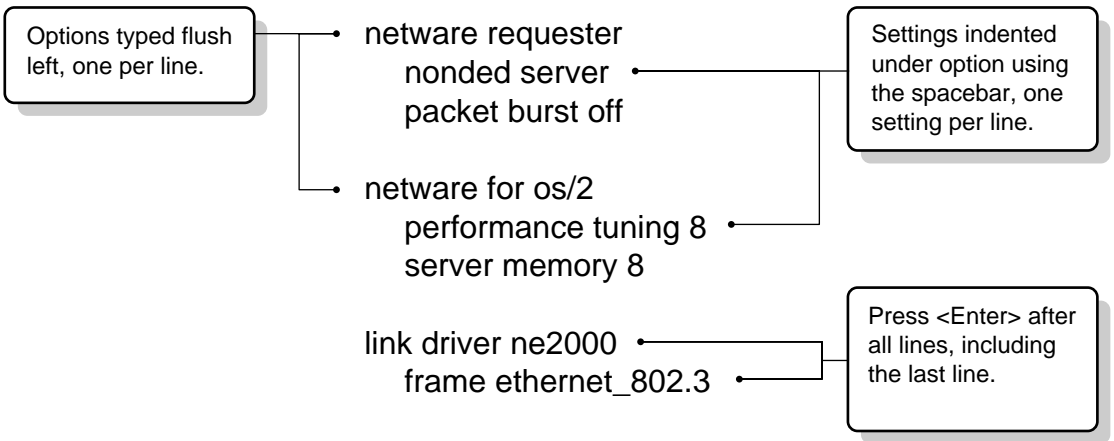
- ◆ Type options at the left margin with no spaces before or after them.
- ◆ Type options in either uppercase or lowercase (they are not case-sensitive).
- ◆ Type one option per line.
- ◆ Type settings, one per line, below the option to which they apply.
- ◆ Use the Spacebar to indent these settings. Settings *must* be indented at least one space.



Do not use <Tab> to indent the setting if you are using the graphical NetWare Server for OS/2 utility to edit the NET.CFG file. Pressing <Tab> activates different windows and buttons in the NET.CFG Options box.

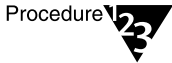
- ◆ Press <Enter> at the end of every line in the file, *including the last line*. If you don't press <Enter> at the end of the last line, the line is ignored.
- ◆ Precede comments with a semicolon.

**Figure B-3**  
**Format of NET.CFG File**



## Editing the NET.CFG File Using the Installation Program

### Procedure



1. Start the installation program by choosing the “Install” icon in the “Novell” group on the OS/2 desktop.
2. In the installation program, choose “This Workstation” from the “Configuration” menu.

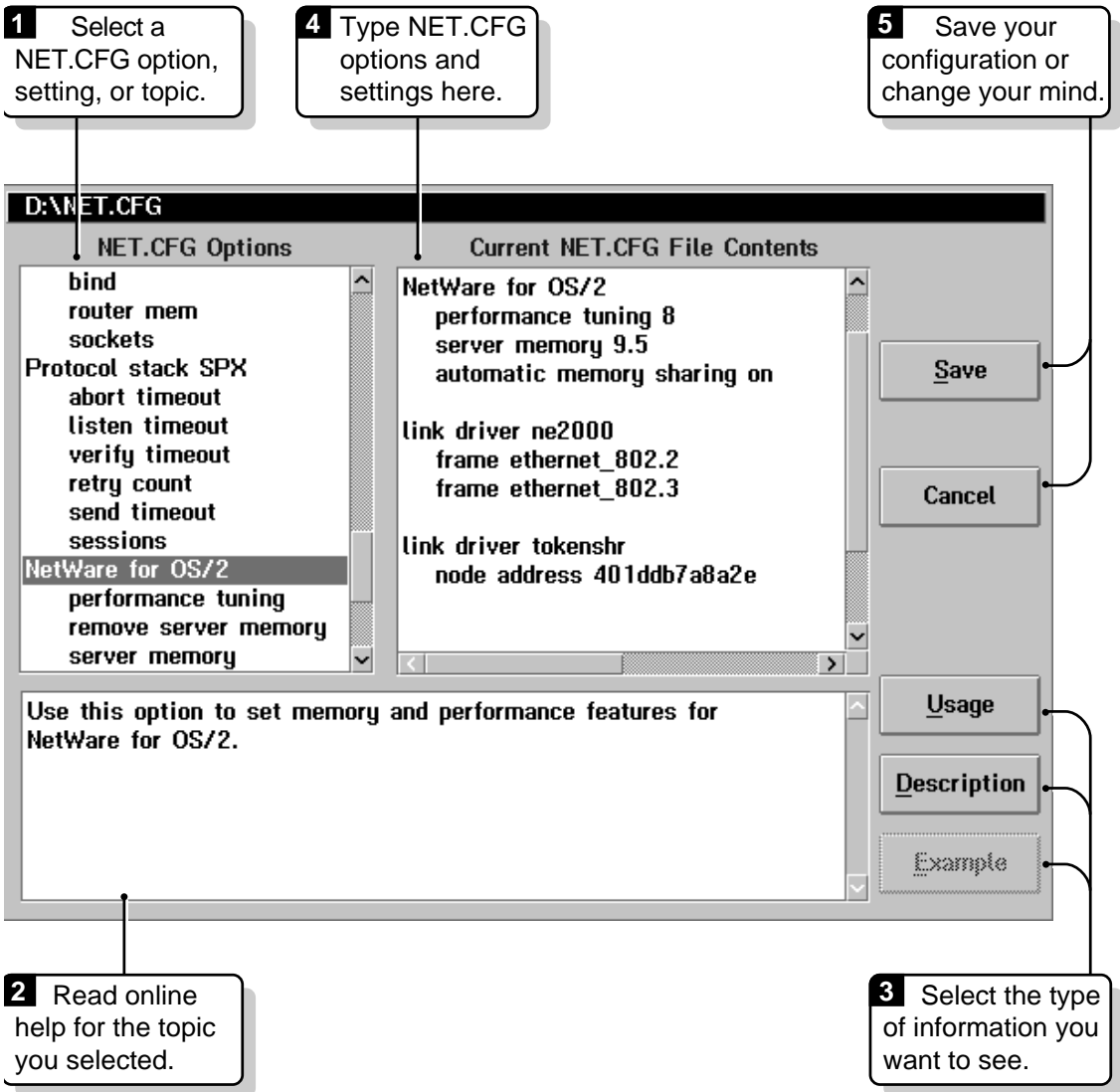
The “Default Location for NET.CFG File” dialog box appears. This dialog box indicates where on your hard disk the NET.CFG file will be placed. (The NET.CFG file is usually placed at the root of the OS/2 boot drive.)

3. Choose “Edit” from the “Default Location for NET.CFG File” dialog box.

A dialog box allowing you to edit the NET.CFG file appears.

4. Use the “Edit NET.CFG” dialog box to add configuration options (see Figure B-4).

Figure B-4  
 “Edit NET.CFG” Dialog Box



## Editing the NET.CFG File Using an OS/2 Text Editor



### Procedure

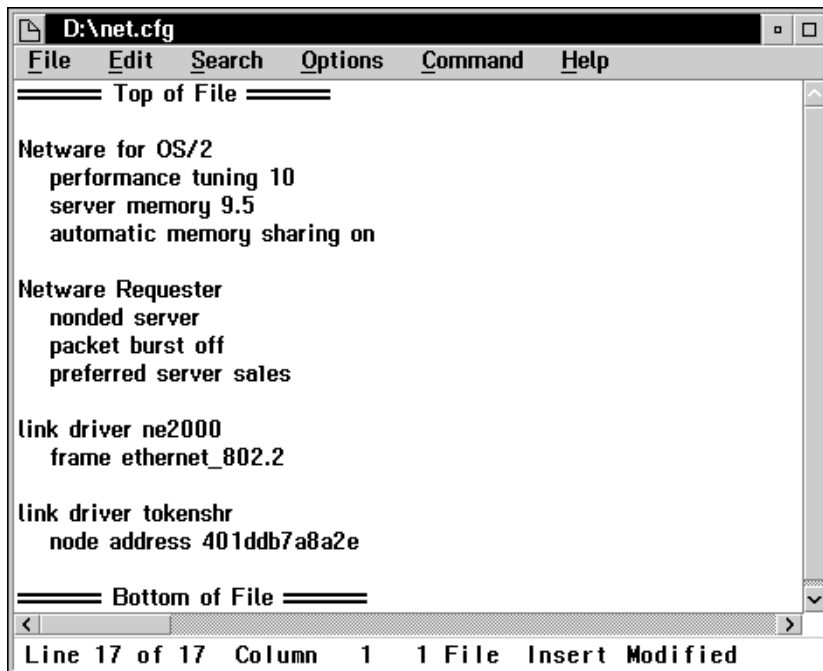
1. Open an OS/2 full screen or window session.

2. At the command line prompt, type

`EPM NET.CFG <Enter>`

An OS/2 text editor appears (see Figure B-5).

Figure B-5  
OS/2 Text Editor



3. Use the editor to add the configuration options you need.

# NET.CFG Options and Settings

The following sections explain the NET.CFG options and settings you can use to enhance NetWare Server for OS/2 performance. Each example includes a description of the option and setting, the default setting, and an example of the proper syntax for entering the option and setting in the NET.CFG file.

## The NetWare for OS/2 Option

Use this option to set memory and performance features for NetWare Server for OS/2.

### Syntax

```
NETWARE FOR OS/2
  PERFORMANCE TUNING number
  INITIALIZATION SCREEN DELAY number
  SERVER MEMORY number
  BASE SERVER MEMORY number
  REMOVE BASE SERVER MEMORY
  ALLOCATE MEMORY value
  AUTOMATIC MEMORY SHARING value
  MAXIMUM SERVER MEMORY number
  BLOCK ALLOCATION SIZE number
```

### Settings

#### Performance Tuning

Use this setting to specify how much processing time is allocated to NetWare Server for OS/2. Whatever is not allocated to NetWare Server for OS/2 is left for OS/2.

#### Syntax

```
NETWARE FOR OS/2
  PERFORMANCE TUNING number
```

Replace *number* with a number from 1 to 10.

The higher the number, the more processing time is allocated to NetWare Server for OS/2 and the faster your NetWare server will run.

**Default** 5

**Example** To set the performance tuning level to 7:

```
NETWARE FOR OS/2
  PERFORMANCE TUNING 7
```

The default setting should be acceptable for your needs. However, you may want to lower the performance tuning level if OS/2 operation is too slow because of the amount of traffic on the server.

### Initialization Screen Delay

Use this setting to specify the number of seconds you want the NetWare Server for OS/2 configuration options screen to remain displayed when OS/2 boots. (The screen displays information about device driver configuration. This screen cannot be used to change the configuration; it is for information only.)

**Syntax** `NETWARE FOR OS/2  
 INITIALIZATION SCREEN DELAY`

*number*

Replace *number* with a number expressed in seconds between 0 and 180.

**Default** 8

**Example** To set a 3-second delay:

```
NETWARE FOR OS/2
  INITIALIZATION SCREEN DELAY 3
```

### Server Memory

Use this setting to specify the amount of memory that you want NetWare Server for OS/2 to allocate from OS/2.

If Automatic Memory Sharing is set to ON, the amount of memory used by NetWare Server for OS/2 and the OS/2 workstation will fluctuate. If Automatic Memory Sharing is OFF, NetWare Server for OS/2 will try to

allocate as much of the memory specified in the Server Memory setting as it can.

**Syntax**            `NETWARE FOR OS/2`  
                      `SERVER MEMORY number`

Replace *number* with a number expressed in megabytes.

**Default**            8

**Example**            To allocate 10 MB of base server memory for NetWare Server for OS/2:

`NETWARE FOR OS/2`  
                      `BASE SERVER MEMORY 10`

### Base Server Memory

Use this setting to allocate a base amount of memory for the server at boot time. If volumes on your server do not mount, increase the amount of base server memory using this setting.

**Syntax**            `NETWARE FOR OS/2`  
                      `BASE SERVER MEMORY number`

Replace *number* with a number expressed in megabytes. Be sure the number you specify is large enough to run the server, but small enough to leave adequate memory for OS/2.

If NetWare Server for OS/2 cannot allocate the amount of memory you specify, it displays a warning message and uses the highest amount it can obtain.

**Default**            4

**Example**            To allocate 8.5 MB of base server memory for NetWare Server for OS/2:

`NETWARE FOR OS/2`  
                      `BASE SERVER MEMORY 8.5`

## Remove Base Server Memory

Use this setting to release the base server memory allocated to NetWare Server for OS/2 so the memory will be available for OS/2 to use. The memory is released when the server is brought down.

**Syntax**            `NETWARE FOR OS/2  
                     REMOVE BASE SERVER MEMORY.`

**Default**            Base server memory is not released.

**Example**            To release base server memory upon bringing down the server:

```
NETWARE FOR OS/2  
                     REMOVE BASE SERVER MEMORY
```

## Allocate Memory

Use this setting to request that memory allocated from OS/2 to the server be allocated above or below the first 16 MB.

**Syntax**            `NETWARE FOR OS/2  
                     ALLOCATE MEMORY value`

Replace *value* with HIGH or LOW.

**Default**            None.

**Example**            To allocate the memory above 16 MB:

```
NETWARE FOR OS/2  
                     ALLOCATE MEMORY HIGH
```

To allocate the memory below 16 MB:

```
NETWARE FOR OS/2  
                     ALLOCATE MEMORY LOW
```

## Automatic Memory Sharing

Use this setting to deactivate automatic memory sharing (it is active as a default). When automatic memory sharing is active, the system



determines the proper amounts of memory for NetWare Server for OS/2 or OS/2 as the server is running.

**Syntax**            `NETWARE FOR OS/2`  
                         `AUTOMATIC MEMORY SHARING value`

Replace *value* with OFF.

**Default**            ON

**Example**            To deactivate automatic memory sharing:

```
NETWARE FOR OS/2
AUTOMATIC MEMORY SHARING OFF
```

### Maximum Server Memory

Use this setting to set the maximum amount of memory that NetWare Server for OS/2 can allocate from OS/2 when manual or automatic memory sharing is active. This prevents NetWare Server for OS/2 from taking too much memory from OS/2.

**Syntax**            `NETWARE FOR OS/2`  
                         `MAXIMUM SERVER MEMORY number`

Replace *number* with a number expressed in megabytes.

**Default**            None.

**Example**            To set the maximum amount of memory that can be used by NetWare Server for OS/2 to 12 MB:

```
NETWARE FOR OS/2
MAXIMUM SERVER MEMORY 12
```

## Block Allocation Size

Use this setting to specify the number of memory pages you want to include in a total block of memory that NetWare Server for OS/2 allocates from OS/2. One memory page is equal to 4 KB of memory.

For example, if you use the default of 8, NetWare Server for OS/2 allocates 8 memory pages in each block of memory. This means that the total size of the memory block is 32 KB (8 memory pages at 4 KB each = 32 KB).

When memory sharing is active, NetWare Server for OS/2 allocates blocks of memory from OS/2 in this size.

**Syntax**            **NETWARE FOR OS/2**  
                         **BLOCK ALLOCATION SIZE** *number*

Replace *number* with a number between 4 and 1024.

**Default**            8

**Example**            To set the Block Allocation Size so that NetWare Server for OS/2 allocates 200 KB in each memory block:

**NETWARE FOR OS/2**  
**BLOCK ALLOCATION SIZE 50**

(50 x 4 KB = 200 KB)

## The NetWare Requester Option

Use this option to control network requests from your workstation to a NetWare server.



There are several settings that can be used with the NetWare Requester™ option. Only the ones that you may want to use with NetWare Server for OS/2 are described in this section.

For information about all the available NET.CFG options and settings, see "NET.CFG Options Reference" in *NetWare Client for OS/2 User Guide*.

### Syntax

**NETWARE REQUESTER**  
**NONDED SERVER**  
**PACKET BURST OFF**

## Settings

### Nonded Server

Use this setting to allow NetWare Server for OS/2 and NetWare Client for OS/2 to use the same network board.

If you specify this setting, NetWare Server for OS/2 must be running on your computer before you can attach to the network using NetWare Client for OS/2 (otherwise, the client displays a connection error).

<b>Syntax</b>	<code>NETWARE REQUESTER NONDED SERVER</code>
<b>Default</b>	NetWare Server for OS/2 and NetWare Client for OS/2 use separate network boards.
<b>Example</b>	To allow NetWare Client for OS/2 and NetWare Server for OS/2 to use the same board:  <code>NETWARE REQUESTER NONDED SERVER</code>
	<b>Note:</b> If your client software will not attach to a NetWare network, it may be because option has not been set.

### Packet Burst Off

Use this setting to disable the Packet Burst feature. For more information about Packet Burst, see “Improving Speed by Using Packet Burst” in *NetWare Client for OS/2 User Guide*.

<b>Syntax</b>	<code>NETWARE REQUESTER PACKET BURST OFF</code>
<b>Default</b>	Packet Burst is enabled.
<b>Example</b>	To disable Packet Burst:  <code>NETWARE REQUESTER PACKET BURST OFF</code>

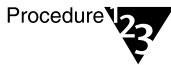
# Using NetWare Server for OS/2 SET Parameters

There are two SET parameters that are used only in NetWare Server for OS/2; PERFORMANCE TUNING and OS/2 DEBUGGER.

## Performance Tuning

The performance tuning level specifies how much processing time is allocated to NetWare Server for OS/2. Whatever is not allocated to NetWare Server for OS/2 is left for OS/2.

### Procedure



1. **Select the NetWare Server for OS/2 console.**
2. **At the console prompt type**

```
SET PERFORMANCE TUNING number <Enter>
```

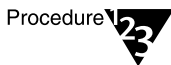
Replace *number* with a number between 1 and 10. The higher the performance tuning level, the more processing time is allocated to NetWare Server for OS/2.

The default performance tuning level is 5.

## OS/2 Debugger

This parameter determines whether NetWare Server for OS/2 uses the NetWare or OS/2 debugger to diagnose and fix server problems.

### Procedure



1. **Select the NetWare Server for OS/2 console.**
2. **At the console prompt type**

```
SET OS/2 DEBUGGER TRUE|FALSE <Enter>
```

Use TRUE if you want the server to use the OS/2 debugger. Use FALSE if you want the server to use the NetWare debugger.

The default is FALSE.

For more information about NetWare SET parameters, see “SET” in *Utilities Reference*.

## Backup Support for NetWare Server for OS/2

Tape backup is supported in NetWare Server for OS/2 through the use of the ASPISHIM.DSK file. ASPISHIM.DSK is an NLM program that presents an ASPI entry point for TAPEDAI.DSK to call from NetWare’s 16/32-bit environment to the ASPI code in OS/2’s 16/16-bit environment.

ASPISHIM.DSK provides a bridge to the ASPI entry point, shuttling requests and results between NetWare and OS/2. The ASPISHIM file is linked as a .DSK file so that it can be loaded from the STARTUP.NCF file.

Regardless of where or when ASPISHIM.DSK is loaded, it must be loaded before TAPEDAI.DSK, because TAPEDAI.DSK is dependent on the ASPI entry point exported by ASPISHIM.DSK.

For tape backup to work in OS/2, a device driver for the host adapter in the machine and a device driver for the ASPI code must be specified in the OS/2 CONFIG.SYS file.

For example, if the host adapter is an Adaptec\* 1540, add the following lines to the CONFIG.SYS file:

```
BASEDEV=AHA154X.ADD  
BASEDEV=OS2ASPI.DMD
```

AHA154X.ADD specifies the OS/2 device driver and OS2ASPI.DMD specifies the ASPI driver.



## ***SFT III Management Tips***

This appendix describes tips for managing and troubleshooting a NetWare® 4.11 SFT III™ network. The information is divided into these categories:

- Server Synchronization
- Mirrored Server Link (MSL)
- Server Configuration (.NCF) Files
- Server Memory
- Server Consoles
- Server Hard Disks
- Network Clients
- Network Performance
- Troubleshooting

The SET command is mentioned frequently in these sections. For more information on the SET command and its parameters, see “SET” in *Utilities Reference*.

# Server Synchronization

This section discusses possible solutions to software failures related to SFT III server synchronization.

## Detecting Server Synchronization Errors

For a comprehensive check of MEngine outputs on each server, turn on the Comprehensive MEngine Synchronization Check SET parameter. By default, a less intrusive check is performed. Using the comprehensive check may affect server performance.

Because this parameter must be set before the servers are activated (only settable at startup), put this command in the IOSTART.NCF file for each server:

```
SET Comprehensive MEngine Synchronization Check=ON
```

## Handling Secondary Restarts Immediately After Synchronization

If the secondary server restarts immediately after synchronization, increase the IPX Internet Down Wait Time and the MSL Deadlock Detect Wait Time SET parameters, using the following syntax:

```
SET IPX Internet Down Wait Time=variable  
SET MSL Deadlock Detect Wait Time=variable
```

If this does not solve the problem, halt the server by changing all mirrored servers' error recovery options to 0. See "Servers Restart for No Apparent Reason" on page 795 for specific options. After halting the server, contact your support representative.

## Notifying Users of Server Synchronization

To send a broadcast message to all logged-in network users when the mirrored servers begin synchronizing, type the following.

```
SET Notify All Users Of Mirrored Server  
Synchronization=ON
```

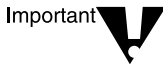
The default setting for this parameter is OFF.



## Reducing the Time for Resynchronizing and Remirroring

To shorten server synchronization time, reduce the amount of memory that must be synchronized, using the following syntax:

```
SET New End Address For Unclaimed Memory  
Block=variable
```



Using this SET parameter to reduce the amount of unclaimed memory may prevent some loadable modules from loading in the MSEngine. If the MSEngine memory is too small, some volumes may not mount.

If you have disk arrays, you may be able to speed up disk mirroring with the Concurrent Remirror Requests SET parameter.

## Responding to “Invalid Mirrored Server Initialization” Messages

If this message appears when the servers are in test mode, no action is necessary as long as the servers continue to synchronize.

To prevent server initialization problems, increase the Restart Minimum Delay Amount, using the following syntax:

```
SET Restart Minimum Delay Amount=variable
```

Also, verify that the MSL boards and cables are functional. Then unload and reload the MSL driver on each server.

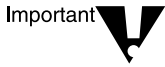
If you are using NE2000™ boards as MSL boards, make sure that the interrupt settings on the MSL boards have a higher priority than the network boards, and that the MSL boards are cabled correctly.



Interrupt priorities from high to low are 0, 1, 2 or 9, A, B, C, D, E, F, 3, 4, 5, 6, 7, and 8. Interrupt 2 is the highest priority you can assign to an MSL board because interrupts 0 and 1 are reserved.

## Responding to “Mirrored Server Engine Already Loaded” Messages

This message means you have already executed the `ACTIVATE SERVER` console command, either at the IOEngine console or in the `IOSTART.NCF` file of the other server. Delete “`ACTIVATE SERVER`” from the `IOSTART.NCF` file.



Putting `ACTIVATE SERVER` in the `IOSTART.NCF` file may cause synchronization problems. If both servers execute `ACTIVATE SERVER` simultaneously, the utility may load two separate, unsynchronized MSEngines, and both servers would assume the primary server role.

## Mirrored Server Link (MSL)

This section discusses possible solutions to hardware and software failures related to the high-speed cable links between the mirrored SFT III™ servers.

### Determining Appropriate MSL Cable Lengths

The maximum cable length between MSL boards is determined by the cable manufacturer. Ranges are from 30 to 100 meters for coaxial cable, and from 1 to 40 kilometers for fiber optic cable.

### Handling MSL Cable or MSL Board Failure

When an MSL cable or board fails, the secondary server restarts but cannot synchronize with the primary server until the MSL problem is corrected.

To prevent future MSL problems and loss of server mirroring, install redundant, alternate MSL boards and cabling in each server. The alternate MSL driver must be loaded before it can take over for an active MSL that fails.

Put the `LOAD` command for the alternate MSL driver in the `IOSTART.NCF` files of both servers, after the `LOAD` command for the first MSL driver. Use the following syntax:

```
LOAD alternate_driver_name
```

The order the drivers are loaded determines which MSL is the default and which is the first alternate, second alternate, and so forth.

## Responding to MSL Communications Error Messages

Check the MSL cable and board connections to make sure they are properly connected and that the boards are firmly seated. Also check for kinks or damage in the cabling.

## Responding to “MSL Deadlock Delivering Data” Messages

This message means that neither MSL can transmit data because of a “holdoff.” A holdoff occurs when the IOEngine receives a packet but cannot process it, or when one MSL sends a packet but doesn’t receive an acknowledgment.

Increase the MSL Deadlock Detect Wait Time, using the following syntax:

```
SET MSL Deadlock Detect Wait Time=variable
```

If the servers are very busy, increase this parameter in 1-second increments until the error disappears.



Make sure the value of the MSL Deadlock Detect Wait Time parameter is at least 1 second longer than the IPX Internet Down Wait Time parameter.

## Server Configuration (.NCF) Files

SFT III reads from these server configuration files, in the following order, when you power on or restart the servers:

- ◆ IOSTART.NCF (two files—one for each server)
- ◆ MSSTART.NCF
- ◆ MSAUTO.NCF
- ◆ IOAUTO.NCF (two files—one for each server)

Most of these files are created during the installation process. Use INSTALL to create or edit server configuration files. You can also use EDIT to edit .NCF files.

**Example:** IOSTART.NCF file (on boot partition)

```
ioengine name SFT3_IO1
ioengine ipx internal net 7654321
load isadisk port=1f0 int=e
load nmsl
```

**Example:** MSSTART.NCF file (on boot partition)

```
set Concurrent Remirror Requests=11
```

**Example:** MSAUTO.NCF file (on volume SYS:)

```
set Time Zone=MST7MDT
set Daylight Savings Time Offset=1:00:00
set Start Of Daylight Savings Time=(APRIL SUNDAY
    FIRST 2:00:00 AM)
set End Of Daylight Savings Time=(OCTOBER SUNDAY LAST
    2:00:00 AM)
set Default Time Server Type=SINGLE
set Bindery Context=O=Novell
msengine name SFT3
msengine ipx internal net 1234567
mount all
```

**Example:** IOAUTO.NCF file (on boot partition or volume SYS:)

```
sys:etc\io1\initsys.ncf
load tcpip
```



To edit INITSYS.NCF, see “INETCFG” in *Utilities Reference*.

## Server Memory

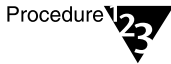
This section discusses how to install additional server memory without disrupting the network and how to respond to the message “Secondary server is missing RAM.”

## Adding Memory Without Bringing the MEngine Down

A NetWare 4.11 SFT III system allows you to upgrade server hardware without loss of service to clients.

Use the procedure below to add memory to your servers without bringing down the MEngine.

### Procedure



1. **Halt the secondary server and turn it off.**

The primary server is still running.

2. **Add memory to the secondary server and turn it on.**

3. **Reconfigure the hardware, using the hardware-specific configuration procedure specified by the manufacturer.**

4. **From the boot prompt on the secondary server, type**

```
MSERVER <Enter>
```

5. **Wait for resynchronization to complete.**

During resynchronization, the primary server does not recognize the additional memory in the secondary server.

6. **After the disks are remirrored, halt the primary server and turn it off.**

The secondary server becomes the new primary server.

7. **Add memory to the new secondary server and turn it on.**



8. **Reconfigure the hardware, using the hardware-specific configuration procedure specified by the manufacturer.**

To ensure synchronization, install the same amount of memory in both SFT III servers.

9. **From the boot prompt on the secondary server, type**

```
MSERVER <Enter>
```

10. **Wait for resynchronization to complete.**

During synchronization, the primary server now recognizes the additional memory in the secondary server.

## Responding to “Secondary Server Is Missing RAM” Messages

This message means that the primary server cannot synchronize memory with the secondary server for one of the following reasons:

- ◆ The primary server has more RAM than the secondary server.
- ◆ The primary and secondary have the same amount of RAM installed, but the memory is noncontiguous and the memory “holes” don’t match.

In this situation, do one of the following:

- ◆ Add memory to the secondary server so that its RAM is equal to the RAM in the primary server.
- ◆ Run the EISA configuration utility (if applicable) so that both servers are in the same mode (linear or compatible mode).
- ◆ Align the server memory holes using the procedure below.

## Procedure

Procedure



1. **Change to the IOEngine prompt on the secondary server.**

**Check the memory addresses by typing**

```
MEMORY MAP <Enter>
```

A display similar to the following appears.

```
System memory map:  
0-12288 (DOS)  
12288-159744 (DOS)  
159744-654336 (IOEngine)  
1048576-5767168 (IOEngine)  
5767168-17170432 (Unclaimed)
```

2. **From the “Unclaimed” range on the last line of the display, write down the “start” and “end” memory addresses.**

Note



Unclaimed memory is used by the MEngine, so it must be identical on both servers.

3. **From the IOEngine console on the *primary* server, type**

```
HALT <Enter>
```

**Add the following commands to the primary server’s IOSTART.NCF file:**

```
SET New Start Address for Unclaimed Memory  
Block=x  
SET New End Address for Unclaimed Memory Block=x
```

The values following the = (equals) sign are the start and end of the unclaimed memory range on the secondary server (the numbers you wrote down in Step 2).

4. **Restart the primary server.**

Now that the unclaimed memory is aligned on both servers, they can synchronize. SFT III allocates any extra memory to the IOEngine on that server.

# Server Consoles

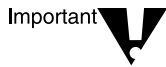
This section discusses solutions for keeping track of the three NetWare 4.11 SFT III server consoles—the two IOEngines and the MEngine—and for managing errors displayed at these consoles.

## Logging and Viewing All Console Messages

Some SFT III console messages are never seen because you can't view all three consoles (two IOEngines and one MEngine) at once.

To keep track of these messages, use CONLOG to capture all console messages and to write them to SYS:\ETC\CONSOLE.LOG.

To log messages from all three consoles, add the line LOAD CONLOG to the IOSTART.NCF files of both servers and to the MSAUTO.NCF file.



The LOAD CONLOG command must be the first line in each .NCF file from which you want to log messages.

To view the CONSOLE.LOG file, use EDIT or INETCFG.

## Handling Lost Interrupt Alerts on the Console

If lost interrupt alerts are filling up the console screen, at the appropriate IOEngine console, type

```
SET Display Lost Interrupt Alerts=OFF <Enter>
```

A lost interrupt message indicates a problem driver or faulty hardware. To find the driver with the interrupt problem, turn on the Display Lost Interrupt Alerts parameter as shown above. Then unload all the drivers from the appropriate IOEngine, and reload them one at a time. Contact the vendor of the problem driver.



## Responding to “Loader Cannot Find...” Messages

This message means you tried to load an NLM in the wrong engine (IOEngine or MSEngine), or that the NLM you tried to load depends on other NLMs that aren't loaded.

Use the <Alt>+<Esc> keys to toggle to the other engine's console, and attempt to load the NLM again.

If the message still appears, you may have loaded an outdated or unsupported NLM.

## Shortening the Console Prompt

Long SET parameter names may scroll behind the console prompt if you have a long IOEngine or MSEngine name in the prompt. However, scrolling does not affect the execution of the SET utility.

If you want a two-character console prompt (IO: or MS:), type the following at the appropriate console:

```
SET Replace Console Prompt With Server Name=OFF <Enter>
```

## Server Hard Disks

This section discusses solutions for hard disk errors and storage shortages on a NetWare 4.11 SFT III server.

### Controlling the Size of Log Files on Volume SYS:

To limit the size of SFT III log files, IO\$LOG.ERR and MSSTATUS.DMP, use the following commands:

```
SET IOEngine Error Log File Overflow Size= number  
SET Status Dump File Overflow Size= number
```

Replace *number* with the size limit in bytes.

The system will delete or rename the log files when they meet or exceed the size limit, depending on the SET IOEngine Error Log File State and SET Status Dump File State parameter values.

## Handling Primary Hard Disk Failure

The primary server remains active if a primary hard disk fails.

In this situation, clients continue to communicate with the primary server, but disk requests use only the secondary server's disk (instead of splitting the seeks between the servers).

Use the procedure below to restore fault tolerance to your server storage.



Make sure the failed disk is on the primary server and that the secondary server's disk is functional before attempting this procedure, or you may lose data.

### Procedure



1. **Change to the primary server's IOEngine console.**
2. **Force a server switchover by typing**  
  
`HALT <Enter>`  
  
The secondary server takes over the primary server role.
3. **Correct the hard disk problems and resynchronize the servers.**
4. **Use the Server Failure Notification Name SET parameter to notify you immediately in case of another server disk failure. Add this parameter to the MSAUTO.NCF file:**

```
SET Server Failure Notification Name=group_name |  
user_name
```

# Mounting a CD-ROM as a NetWare 4.11 SFT III Volume



Warning

Access to data on a CD-ROM volume will be lost if the SFT III servers switch from primary to secondary unless you mount the same CD on both servers.

To mount a CD-ROM disc as a NetWare 4.11 SFT III volume, follow these steps.

## Prerequisites



Checklist

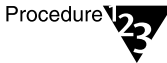
- A mounted volume SYS:
- An installed Host Bus Adapter (HBA) that is NetWare compatible and supports CD-ROM devices
- The NPAIO.DSK and NPAMS.NLM NetWare Peripheral Architecture (NPA) modules
- The disk driver files and necessary support modules for the CD-ROM device



Note

Some disk drivers consist of more than one file and some HBA devices require additional support modules for CD-ROM functionality. These files should accompany the HBA. For specific file requirements, consult your adapter documentation.

## Procedure



Procedure

1. **Change to the IOEngine prompt of the SFT III server where the HBA is installed.**
2. **Load the disk driver by typing**

```
LOAD [path]disk_driver <Enter>
```

Replace *disk\_driver* with the name of the disk driver specified in the HBA documentation.

For example, to load the disk driver for the Adaptec AHA-1522 SCSI HBA, type

```
LOAD [path]AHA1520.DSK <Enter>
```

```
LOAD [path]ASPICD.DSK <Enter>
```

### 3. Load CDROM.NLM by typing

```
LOAD CDROM <Enter>
```

This auto-loads the NPAMS module



When a CD-ROM is mounted or a CD-ROM disc is changed, some CD-ROM devices may be deactivated. This deactivation occurs because device configuration information is being updated.

### 4. View the device number and volume name by typing

```
CD DEVICE LIST <Enter>
```

### 5. Mount the CD-ROM as a volume by typing

```
CD MOUNT [device number] | [volume name] <Enter>
```

Replace *device number* with the device number or replace *volume name* with the volume name of the CD-ROM disc.

For example, to mount the NetWare\_41 CD-ROM, type

```
CD MOUNT NETWARE_41 <Enter>
```



It may take several minutes to mount the volume the first time, depending on the size of the CD-ROM and the speed of your computer.

The standard volume mount messages appear.

### 6. To mount the CD-ROM as a NetWare volume each time the server comes up, edit the IOSTART.NCF file of the SFT III server where the HBA is installed. Add these commands to the IOSTART.NCF file:

```
LOAD [path]disk_driver
```

### 7. Edit the MSAUTO.NCF file, adding these commands:

```
LOAD CDROM
```

```
CD MOUNT [device number] | [volume name]
```

## Notifying Users of Disk or Server Failure

To notify a user or group of users about a disk or server failure, use the Server Failure Notification Name SET parameter in the MSEngine. Also put this parameter in the MSAUTO.NCF file. For example:

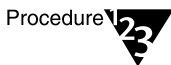
```
SET SERVER FAILURE NOTIFICATION NAME = ADMIN
```

When a failure happens, the specified user or group receives a broadcast message. To send this broadcast message to all logged-in users, use group EVERYONE.

## Recovering an Orphaned Partition

Use the following procedure to recover an orphaned partition:

### Procedure



1. **Load INSTALL.**
2. **From the “Installation Options” menu, choose “Disk Options.”**
3. **From the “Available Disk Options” menu, choose “Mirror/Unmirror.”**

The “Partition Mirroring Status” appears, showing one mirrored and one out of sync. The out-of-sync partition is the “orphan.”

4. **Choose the mirrored partition.**

The “Mirrored Disk Partitions” menu displays the partition number and device number of each mirrored set. The device number for the out-of-sync partition is an “unavailable device.”

5. **Remove the partition from the set by highlighting the out-of-sync partition and pressing <Delete>.**
6. **Return to “Disk Partition Mirroring Status” by pressing <Esc>.**

“Not mirrored” appears by the good partition, and “Out of sync” appears by the other partition. Note the number of the “not mirrored” partition.

7. **Highlight the out-of-sync partition and press <F3>.**

A warning message similar to the following appears:

```
Warning!! The selected partition contains "Volume  
SYS Segment 0" and that volume is already defined.
```

8. **Select the "No Salvage" option.**
9. **Select the good partition (as noted in Step 6).**
10. **Press <Insert> for a list of the available partitions.**
11. **Highlight the previously orphaned partition and press <Enter>.**
12. **Continue by pressing <Esc>.**

The unavailable partition is deleted. After a brief delay, the remirroring process begins. Because the entire partition is remirrored, the process takes several minutes or hours, depending on the partition size. You can check remirroring status with the MIRROR STATUS command or by watching the install screen.

## Network Clients

This section discusses solutions for workstation problems that may be encountered on NetWare 4.11 SFT III networks.

### Finding a Server from an Ethernet Workstation

Some Ethernet clients may have problems finding or attaching to a server.

If you use the 802.3 frame type, change the value of the Enable IPX Checksums SET parameter to 0 in the MSEngine by typing the following:

```
SET Enable IPX Checksums = 0 <Enter>
```

The default setting is 0. Also, make sure volume SYS: is mounted.

## Finding the SFT III Server First

If another NetWare server is on the same network segment as an SFT III server, clients will not find the SFT III server first.

Because the IOEngine routes the get-nearest-server request to the MSEngine, the SFT III server appears to be two hops away while the other NetWare server appears to be closer.

To find the SFT III server first, include the following statement in the client's NET.CFG file:

```
Preferred Server=<MSEngine_name>
```

## Handling DOS IPX Session Timeouts During Server Switchover

If DOS IPX™ clients are timing out or losing connections when the servers switch over, increase the IPX retry count parameter in the NET.CFG file on clients using IPX. For example:

```
ipx retry count 40
```

## Logging in ARCnet or Token Ring Clients Immediately After a Halt

Some clients on token-passing networks may have problems logging in after a server has been halted. Wait for the client to time out; then try to log in again.

## Responding to “LAN Driver Loopback Error Detected” Messages

This message indicates that two or more ARCnet boards have the same node address. Reconfigure each board to a unique address.

## Turning Off the IPX Checksum Option for Token Ring

Token ring doesn't support the enabling of IPX checksums. If you are on a token ring network, change the value of the Enable IPX Checksums SET parameter in the MSEngine to 0 by typing the following:

```
SET Enable IPX Checksums = 0 <Enter>
```

# Network Performance

This section discusses methods of optimizing network performance.

## Handling Frequent Ups and Downs of the IPX Internet

This situation indicates a faulty network connection or a problem with communication between the servers.

Use SET to increase the IPX Internet Down Wait Time and the MSL Deadlock Detect Wait Time parameters by 0.5 second or more.

```
SET IPX Internet Down Wait Time = variable  
SET MSL deadlock Wait Time = variable
```

The value of *variable* should be 0.5 second greater than the current value. If this solves the problem, put the SET commands in the IOSTART.NCF files. If it does not solve the problem, increase *variable* again.

Also, check the network cabling attached to each server and the network connections (including routers and bridges) between the servers.

Make sure the interrupt priority of the MSL board is higher than the interrupt priority of the network boards in each NetWare server.

In most cases, this means setting the MSL interrupt to a lower number. (See the MSL board manufacturer's documentation for more information on setting interrupts.)



Interrupt priorities from high to low are 0, 1, 2 or 9, A, B, C, D, E, F, 3, 4, 5, 6, 7, and 8. Interrupt 2 is the highest priority you can assign to an MSL board because interrupts 0 and 1 are reserved.



## Responding to “IPX Network No Longer Returning Status” Messages

This message indicates a problem with a network connection: either a faulty network board in one of the servers, a cabling problem in the network, or an incorrectly bound network protocol.

If this server is the primary server, and the system determines that the other server has more functional network boards, that server will become the primary.

To determine if a server’s network board has failed, type the CONFIG command at each server’s IOEngine prompt.

A “not sending” or “not receiving” message indicates a bad board or a faulty network connection.

If this message frequently recurs with the message, “IPX Network is now returning status check packets,” increase the IPX Internet Down Wait Time SET parameter to give the system a little more time before determining that a network board has failed. Use the following syntax:

```
SET IPX Internet Down Wait Time = variable
```

## Handling Primary Network Board Failure

If a network board in the primary server stops transmitting or receiving packets, the secondary server assumes the primary role *only* if the following conditions are true:

- ◆ The secondary server’s network boards are more functional than the primary’s network boards.
- ◆ The servers are fully synchronized and their disks are completely mirrored.

Three SET parameters in the IOEngine can help detect and prevent downtime caused by network board failure: Check LAN Option, Check LAN Extra Wait Time, and Use Diagnostic Responder to Validate LAN Functionality.

### **SET Check LAN Option=2**

This setting (2 is the default) forces a server switchover by restarting the primary server if a network board fails in the primary.

### **SET Check LAN Extra Wait Time=10**

This setting adds 10 extra seconds to the time the system waits before forcing a switchover because of a bad network board in the primary server.

By default this setting is 0, but if you have a large network or heavy traffic on the network, you may want to increase the wait time to prevent a premature server switchover.

### **SET Use Diagnostic Responder to Validate LAN Functionality=ON**

This setting broadcasts an IPX diagnostic request to verify that a network board is functional.

By default this setting is OFF because the diagnostic request adds traffic overhead and can hurt performance of large networks.

However, if you want to know whether a network board is bad or just slow, set this parameter to ON.

## **Troubleshooting**

This section suggests solutions to various problems that can occur with NetWare 4.11 SFT III networks.

### **Both Servers Are Primary; No Secondary Console Display**

ACTIVATE SERVER was executed from both IOEngines, and both servers have assumed the primary server role. Delete "ACTIVATE SERVER" from the IOSTART.NCF file. Restart one server.

Make sure the node addresses on the network boards are unique to each server.

## Disks Won't Mirror After Servers Synchronize

Verify that the correct disk driver is loaded in each server's IOEngine. Also, put the load command for the disk driver in each server's IOSTART.NCF file.

Check the mirror status in the INSTALL.NLM for orphaned drives.

## "Error IPX internet may be too slow" Message Appears

A busy IPX network or busy routers between SFT III servers can cause this message:

```
IPX internet may be too slow to notify secondary
server if MSL fails... increase secondary take over
delay amount.
```

If "I'm alive" packets take too long to travel between the servers over IPX, the secondary server may prematurely take over for the primary server.

To prevent this, use the SET command in the IOEngine to increase the Secondary Take Over Wait Time. Use the following syntax.

```
SET Secondary Take Over Wait Time = variable
```

Also check for problems with network connection that may be slowing IPX.

## "Error transferring IOEngine error log to MEngine" Message Appears

Volume SYS: may not have mounted. If the volume is mounted, check the file attributes of the IOSLOG.ERR file to verify the file isn't flagged as Read Only.

If the problem persists, there may not be room for the file on volume SYS:. Delete or rename the IOSLOG.ERR file on the boot partition.

## “Inactive device associated with mirror partition” Message Appears

This message is caused by one of the following situations:

- ◆ The MSEngine was brought down, but only one server was brought back up.
- ◆ The disk driver on one server didn't load correctly.
- ◆ A hard disk or controller failed.

Correct any hardware problems associated with the failure and bring both servers back up.

## IOEngine Network Number Prompt Appears After Executing IOSTART.NCF

Check both IOSTART.NCF files to make sure they assign unique internal network numbers to each IOEngine.

Check the spelling and syntax of the IPX internal network number command. There should *not* be an equal sign (=) in the command.

Make sure the IOSTART.NCF file is in the same directory as the MSERVER.EXE file on each server.

## Keyboard Is Slow or Frozen After Loading ARCnet on IRQ 2

Make sure there are no I/O port or memory address conflicts.

## LOGIN Fails, Even If Correct Password Is Given

If checksumming is disabled at the workstation, it must also be disabled at the server. Change the value of the Enable IPX Checksums SET parameter in the MEngine to 0, using the following syntax:

```
SET Enable IPX Checksums = 0
```

This may also indicate a problem with the user's Directory context.

## LOGIN Fails for an NLM in the IOEngine

This happens only in the case of a backup NLM that logs in to the server using a different user name and would happen only on the secondary IOEngine. Type the following.

```
SET Reply To Get Nearest Server = ON <Enter>
```

## MSEngine Name Prompt Appears Even Though MSAUTO.NCF Exists

Volume SYS: did not mount, or the command was typed incorrectly in the MSAUTO.NCF file.

There should *not* be an equal sign (=) in the MSEngine name command.

Type in the MSEngine name and IPX internal network number. Edit the MSAUTO.NCF file if necessary.

Make sure the disk drivers are loaded in both IOEngines. Mount volume SYS: from the command line or with INSTALL. If volume SYS: is unable to mount, run VREPAIR and try mounting it again.

## MSL Drivers Are Loaded But Servers Do Not Synchronize

You might have installed the MSL boards incorrectly. Check the following on each server:

- ◆ Interrupt settings on the MSL boards (for conflicts with the network boards)
- ◆ MSL cables and board connections
- ◆ MSL drivers (both servers must have the same version of the driver)

## MSL Isn't Activated

Verify that the same MSL driver is loaded on each server and that the MSL boards and cables are installed correctly.

## MSL Times Out When a Device Driver is Loaded

Load the device driver before loading the MSL driver, or use the SET utility in the IOEngine to increase the MSL Error Wait Time value. Use the following syntax:

```
SET MSL Error Wait Time = variable
```

If this solves the problem, put the SET command shown above in the IOSTART.NCF file, above the LOAD command for the MSL driver.

## “Other Server Requested This Server to Halt” Message Appears

The following sequence of events causes this message to appear:

1. The secondary server stops receiving “I’m alive” packets from the primary server over the IPX network.
2. The MSL between the two servers fails.
3. The secondary server begins to take over as primary (because of no “I’m alive” packets).
4. The secondary server then receives an “I’m alive” packet from the primary server.
5. Because two primary servers can't coexist, the secondary server halts.

Check for hardware problems on the IPX network and the MSL connection. If there are no hardware problems, use SET in the IOEngine to increase the Secondary Take Over Wait Time, using the following syntax:

```
SET Secondary Take Over Wait Time = variable
```

### Primary Server Doesn't Know IPX Route to Secondary Server

Verify that

- ◆ Both IOEngines are active
- ◆ The LAN drivers are loaded in both IOEngines
- ◆ The protocols are bound to the network boards in both servers

Use SET to increase the IPX Internet Down Wait Time and the MSL Deadlock Detect Wait Time parameters, using the following syntax:

```
SET IPX Internet Down Wait Time = variable  
SET MSL Deadlock Detect Wait Time = variable
```

Check the network cabling and the network boards and routers between the SFT III servers to verify they are functioning properly.

### Queue Overrun Abend Occurs

Decrease the number of seconds in the IPX Internet Down Wait Time and the MSL Deadlock Wait Time SET parameters in the IOEngine, using the following syntax:

```
SET IPX Internet Down Wait Time = variable  
SET MSL Deadlock Detect Wait Time = variable
```

## Secondary Doesn't Switch Over When Primary LAN Driver Is Unloaded

The secondary server is designed to take over for the primary server if the secondary server detects a network board failure in the primary.

However, an unloaded LAN driver is not considered a hardware failure, since it was explicitly requested by a user at the server console.

Therefore, if a LAN driver in the primary server is unloaded, both the primary and the secondary server will report they aren't receiving "I'm alive" packets, but the secondary server will not switch over.

When the LAN driver is reloaded, the primary server will continue to function as primary.



Any activity in progress when the LAN driver is unloaded from the primary server will be suspended, and client connections will time out unless the driver is promptly reloaded.

## Server Failure Occurs

Because the MSEngines on both SFT III servers are mirrored and the IOEngines are not, you can assume the following about most server failures:

- ◆ If both servers fail or have an abend condition, the failure is probably related to software running in the MSEngine.
- ◆ If one server fails and the remaining server assumes the role of primary server, the failure is probably related to hardware, or to a driver or NLM loaded in the failed server's IOEngine.



## Servers Restart for No Apparent Reason

You may have the wrong values for the recovery option SET parameters, or server test mode is causing constant switchovers. Check the IO\$LOG.ERR and MSSTATUS.DMP files for the cause of the problem.

Use these SET parameter values in both IOEngines to halt the server (without restarting it) so you can see the error:

```
Test Mode=0
Secondary Server MSL Send Blocked Recovery Option=0
Primary Server MSL Send Blocked Recovery Option=0
MSEngine Abend And Processor Exception Recovery
  Option=0
IOEngine Abend And Processor Exception Recovery
  Option=0
Machine Check Recovery Option=0
Memory Parity Error Recovery Option=0
Secondary Server MSL Hardware Failure Recovery
  Option=0
Primary Server MSL Hardware Failure Recovery Option=0
MSEngine Outputs Different Recovery Option=1
Secondary Server MSL Consistency Error Recovery
  Option=0
Primary Server MSL Consistency Error Recovery
  Option=0
Secondary Server MSL Deadlock Recovery Option=0
Primary Server MSL Deadlock Recovery Option=0
```

## SFT III Error Log Files

When a failure occurs, SFT III updates three error log files in the SYS:SYSTEM directory:

- ◆ IO\$LOG.ERR records the activity of both IOEngines.
- ◆ SYS\$LOG.ERR records the MEngine activity.
- ◆ MSSTATUS.DMP records status dumps of engine states, synchronization and communications states, IOEngine to MEngine requests, and other information following a failure or server switchover.

Use these error log files to track the events that occurred prior to a failure or following a switchover.



The IO\$LOG.ERR file on the failed server is written to its boot partition until the servers come back up. Then, the IO\$LOG.ERR file from the boot partition is appended to the IO\$LOG.ERR file on volume SYS:.

### “Should This Machine Become the Primary Server?” Message Appears

The message above appears on the secondary server’s console preceded by

```
All communication channels with the primary server
have failed. Since the IPX network communication
channel failed before the mirrored server link
failed, the secondary is unable to determine if the
primary server is still active.
```

Verify that the primary server has failed, and then type “Y.” If the primary server is still active, type “N.”

## Test Mode Is No Longer Working

You can set the Test Mode parameter from the command line. For example

```
SET Test Mode = variable
```

However, Test Mode resets to the default (no test) the first time that server is automatically downed and rebooted.

To keep the server in test mode, put the SET command line shown above, using the appropriate parameter, in the IOSTART.NCF file of both SFT III servers.

If your drives are not mirrored, the primary server will not initiate test mode. In this case use INSTALL to remirror the drives.

## “Unknown Command” Message Appears

Use the <Alt>+<Esc> keys to toggle to the other engine’s console; then execute the command again.

Use the LOAD command to execute modules (such as INSTALL and MONITOR).

## “Unknown SET Parameter Name” Message Appears

Use the <Alt>+<Esc> keys to toggle to the other engine’s console; then retype the SET command.

Check the spelling and syntax of the SET parameter and retype it correctly.

## Volume SYS: Does Not Mount

Load VREPAIR. If VREPAIR does not load, halt the primary server by typing

```
HALT <Enter>
```

Execute MSERVER with the -ns parameter. Then reload the disk driver and load VREPAIR.



When VREPAIR is loaded, Option 2 must be set to "Write all directory and FAT entries out to disk" and Option 3 must be set to "Write changes immediately to disk."

Make sure you are using the latest disk driver.

### **Workstations Cannot Find or Attach to a Server**

Make sure that

- ◆ Volume SYS: is mounted
- ◆ The appropriate network drivers are loaded on each SFT III server
- ◆ Novell® Directory Services™ (DS.NLM) is loaded
- ◆ The LAN protocols are bound to the network boards
- ◆ The workstation and server are using the same frame type

### **Workstations Time Out During Server Resynchronization**

Change the IPX retry count in the NET.CFG file on the workstations to a higher value. For example:

```
ipx retry count 40
```

Turn on the SET parameter Notify All Users Of Mirrored Server Synchronization in the MSEngine to broadcast a message to all users when synchronization occurs. Use the following syntax.

```
SET Notify All Users Of Mirrored Server  
Synchronization = <group name>
```

## appendix **D** *Creating Menus*

### **Creating, Converting, and Modifying Menu Files**

Menus create a simple front end to the users' working environment. They make it easy to access network resources by presenting a list of options.

Menus can be shared by multiple users, requiring the creation of fewer menus. Or, for the unique requirements of some users, custom menus can be easily created as needed.

In the NetWare 4™ operating system, NMENU.BAT replaces the MENU.EXE utility included in earlier versions of NetWare®. NMENU files are easy to script, require less memory, and run faster than did the old MENU utility files.

Existing menu files from earlier NetWare versions can be easily converted for use by the newer NMENU program (see "Converting Old Menu Files" on page 825). NMENU works in all versions of NetWare 2, NetWare 3™, and NetWare 4™.

Because NMENU relies on special files to execute, and those files are dependent upon a few special commands, this chapter focuses on use of the scripting commands that make up a menu file.

Guidelines for planning your menus are located in "Planning Your Menus" on page 807. Commands and their usage are explained in "Using the NMENU Commands" on page 807. Several example programs are given in "Creating a Menu File" on page 820.

Making menus available to users (see "Setting Up the User Environment" on page 823) and converting old menu files (see "Converting Old Menu Files" on page 825) are the final two topics of this chapter.

# Getting Acquainted with NMENU

Since the sole function of NMENU is to cause a scripted file to execute, there is little to learn about NMENU.BAT except its syntax. The command is followed by the menu filename.

## NMENU Syntax

```
nmenu filename
```

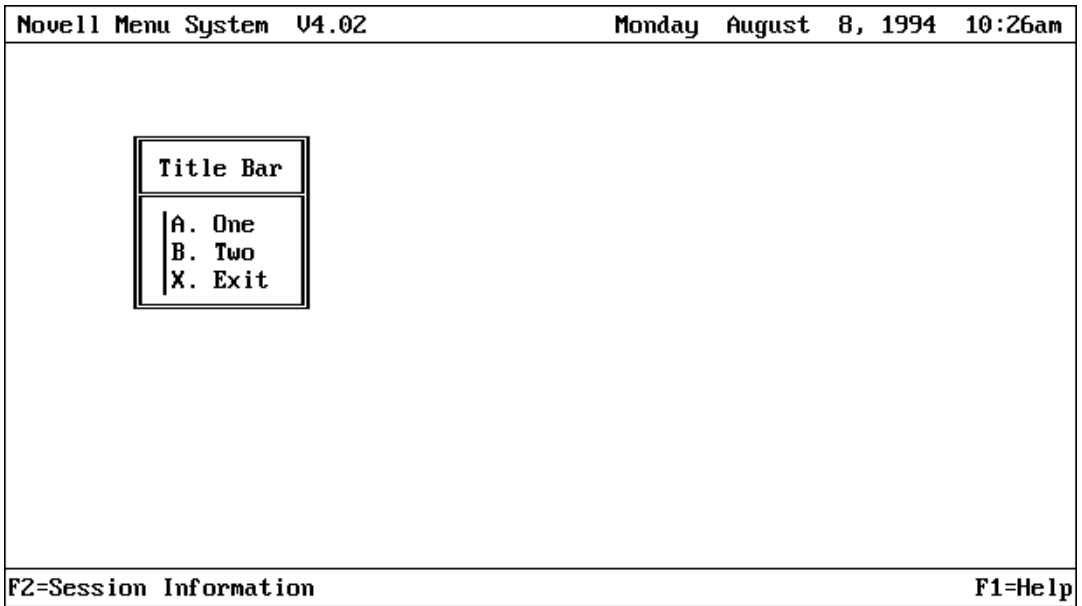
Replace *filename* with the menu filename.

## What Menus Look Like

Figure D-1 shows the display created by a single-window menu with only three options. Whether a menu displays one or more windows, the top and bottom bars of the screen remain the same.

The top bar always displays the NMENU version number on the left and the day, date, and time on the right. The bottom bar displays the available options.

Figure D-1  
A Single-Window Menu



When you create menus with multiple windows, the windows cascade from left to right (see Figure D-3). Window sizing is automatically determined by the content of each window.

## What Makes Menus Work

You create menu files with a text editor and save the file with a .SRC extension. Then you use the MENU MAKE program to compile the file. It is given a .DAT extension and, as a compiled file, is no longer editable. Any edits must be made to the .SRC file and then the .SRC file must be recompiled.

### Elements of a Menu

There are three primary elements to every menu: MENU, ITEM, and EXEC. As these elements are expanded and repeated, controlled options are displayed within each window.

Figure D-2 shows the .SRC file used to create the menu in Figure D-1. This file shows how these three elements are used. Details about these elements and their options are covered later in the chapter.

**Figure D-2**  
**Primary Elements of**  
**a Menu**

```
Menu 1,Title Bar
  Item One {pause}
    Exec dir
  Item Two {show pause}
    Exec ver
  Item ^XExit
    Exec EXIT
```

◆ **Element 1: MENU**

MENU specifies a window within the menu file. It includes a menu number and a menu name. The menu name is the title bar for the menu.

◆ **Element 2: ITEM**

ITEM includes the text the user will see. It is given an indicator letter by default, or you can determine the character to precede it. Each option to be displayed in the window must be preceded by the word ITEM. Some options are available for the ITEM line; these options are discussed in “ITEM” on page 810.



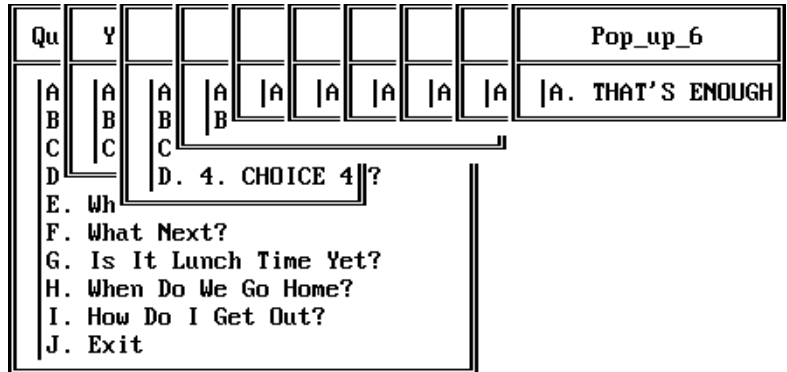
◆ Element 3: EXEC

EXEC is the primary command for the third element. In the menu file shown in Figure D-2, EXEC issues three separate commands: a directory listing, a display of the current version of DOS running, and a command to exit the menu.

**Combining the Elements**

Figure D-3 illustrates a menu with 10 windows, created by including 10 MENU commands in the same file. Each window is automatically sized and cascaded across the screen.

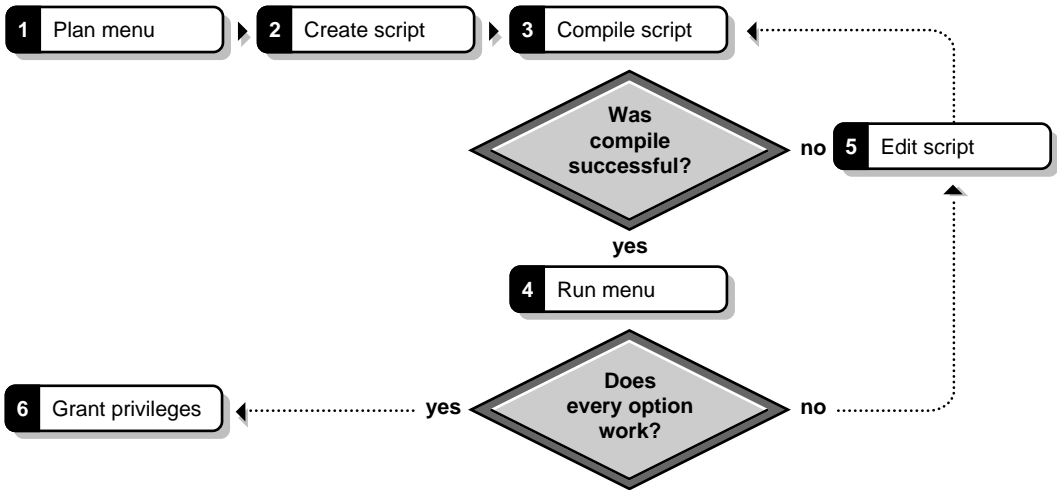
**Figure D-3  
A Multiple-Window  
Menu**



## Menu Creation Steps

There are generally six steps to follow when considering a new menu. The relationship between steps is shown in Figure D-4.

Figure D-4  
Charting the Steps in Creating a Menu



### Procedure

Each step in the flowchart is explained below.



- 1. Plan and design your menu. Before starting, answer the following questions:**
  - ◆ Who is it for?
  - ◆ What do the users need access to?
  - ◆ Should they have access to a NetWare prompt?
  - ◆ Should they be forced to log out when exiting?
  - ◆ How complex is the menu? Will it need to be in multiple files?
- 2. Use a text editor to create your menu with a .SRC extension.**
- 3. Compile the .SRC file with the MENUMAKE program. This will create a .DAT version of the file.**

The results of any errors occurring during the compile process, including detailed error messages per line of script, are displayed on your screen. Fix the errors in the .SRC version of the file according to the error messages, and then recompile. When you have eliminated all of the errors, continue with Step 4.

4. **Run NMENU *filename.dat* to verify that it does what you expect.**
5. **Change the program if needed, as described in Step 3, and then repeat Step 4. When Step 4 is successful, go on to Step 6.**
6. **Provide access to the intended users by placing the .DAT file in an appropriate directory and granting sufficient rights to the users.**



Note

Information on placement of files and required rights is in “Making Menus Work” on page 822.

Following these six steps can help you learn how to use the scripting language and how to manage the menu files you create.

Use of the NMENU program is almost unlimited. When considering the uses for menus, remember that they can be as simple as presenting available application programs (see Figure D-5).

**Figure D-5**  
**Example of a Simple**  
**Menu**

Av	Available Word Processors
A	A. WordPerfect 5.1
B	B. WordPerfect 6
X	C. Word

They also can be more complex, such as guiding data entry for cataloging (see Figure D-6).

**Figure D-6**  
**Example of a More Complex Menu**

Data Entry
A. Add Entry to Catalogue
User Input Requested
Enter Title Enter Author's Name Category: 1=Apps, 2=Prod, 3=Self

The text used to create the four menus shown in this section (Figure D-1, Figure D-3, Figure D-5, and Figure D-6) is included in "Example Menu Programs" on page 820.

Before you look at how these menus were created, however, you should be familiar with the guidelines for planning menus and with the scripting language rules.

# Planning Your Menus

Several considerations are important when planning a menu. Details are presented throughout this chapter, but some general rules include the following:

- ◆ You must include an EXIT or LOGOUT command in the menu to be able to leave the menu. For security reasons, the Esc key doesn't work.
- ◆ The maximum number of windows per menu is 11 (1 main window and 10 subwindows).
- ◆ The maximum number of menus you can define in a single file is 255.
- ◆ The maximum "MENU" name length (title bar) is 40 characters.
- ◆ The maximum number of "ITEM" lines per window is 12.
- ◆ The maximum width of each window "ITEM" is 40 characters.
- ◆ The maximum text file width is 78 characters.
- ◆ The main menu must be at the beginning of the .SRC file.
- ◆ Submenus defined in the same file are called with the SHOW command by menu number.
- ◆ Menus in separate files are called as submenus, by menu name, with the LOAD command.
- ◆ If a command wraps to another line, type a plus sign (+) at the end of the line and continue the command on the next line.
- ◆ Menu colors are determined by the settings in the COLORPAL utility. See "COLORPAL" in *Utilities Reference*.

## Using the NMENU Commands

Menu programs use two types of commands: organizational and control. The following sections describe these commands and their options.

## NMENU Organizational Commands and Options

Organizational commands establish the content and organization of the menus the user sees on the screen. Use these commands to determine what the menus look like.

Table D-1 gives an overview of the organizational commands. Detailed information about each command follows the table.

Table D-1

### NMENU Organizational Commands

Command	Explanation
MENU	Marks the beginning of a new menu or submenu screen in the text.
ITEM	Identifies an item to be listed on the menu. Specifies execution parameters.

## MENU

Indicates a new window definition within your menu file.

### Command Format

**MENU** *menu\_number, menu\_name*

Replace *menu\_number* with the number you want to assign to this menu. Menus are called and displayed by their number.

A menu number can be any number from 1 through 255. Each menu within a source file must be assigned a unique number, but the number sequence doesn't matter.

Replace *menu\_name* with the title you want to appear at the top of the menu. Menu names can be a maximum of 40 characters long.

### Using MENU

The first menu defined in the source file is always the first menu displayed, no matter what number is assigned to it. Subsequent menus are referenced by their numbers, no matter what order they appear in the .SRC file.

For example, if you have defined three menus and assigned them numbers 1, 2, and 5, and menu 5 is the first menu in the source file, menu 5 is displayed first. Menus 1 and 2 are referenced in control commands and displayed depending upon user selection.

### Example

To define a main menu for a program to be used by accountants in your company, type a line similar to the following:

```
MENU 1,Accounting Main Menu
```

Since this is the first menu you want to appear, place it at the beginning of your menu program.

## ITEM

Indicates an option in the menu.

### Command Format

```
ITEM item_name {[option...]}
```

Replace *item\_name* with the list item you want to appear in the menu. The maximum length for an item is 40 characters.

Replace *option* with one or more of the options shown in the following table. Separate multiple options with a space. Enclose all options for a single ITEM in a single set of braces.

These options provide you with better control of menu execution. You determine how memory is used, which directory the user remains in, and what information is presented to those users.

Table D-2

### ITEM Command Options

ITEM Option	Explanation
BATCH	<p>Removes the menu program from memory before executing the item.</p> <p>Without this option, a portion of the memory stays resident, requiring approximately 32 KB of available memory, even though an application may be running.</p> <p>For example, if you enter</p> <pre><b>ITEM Word 5.0 {BATCH}</b></pre> <p>the menu program is removed from memory when Word 5.0 is executed.</p> <p>Setting this option automatically sets the CHDIR option. Don't use this command with the EXEC DOS command; use EXEC CALL.</p> <p>For more information, see "EXEC" on page 814.</p>



Table D-2 *continued*

**ITEM Command Options**

ITEM Option	Explanation
CHDIR	<p>Changes back to the drive and directory that were in effect before an ITEM was executed.</p> <p>For example, to change back to the drive and directory the user was in before executing a word processing application in another directory, type]</p> <p>ITEM WordPerfect 5.0 {CHDIR}.</p> <p>When the word processing application is closed, the directory is changed to the original directory for the menu.</p>
PAUSE	<p>Allows users to read messages associated with a command being executed from the menu, by pausing the screen display.</p> <p>The message "Press any key to continue" is also displayed, and the screen does not change until a user presses a key.</p> <p>For example, to display a message when a user selects the item "DOS Copy" from the menu, include the line:</p> <p>ITEM DOS Copy {PAUSE}</p> <p>When the copy function is complete, the display waits at the "Press any key..." prompt for a key to be pressed before returning to the menu.</p>
SHOW	<p>Displays the command name, such as COPY or DIR, in the upper left corner of the screen.</p> <p>For example, if you enter</p> <p>ITEM Copy Files {SHOW}</p> <p>the DOS command COPY is displayed when the item is executed.</p>

## Using ITEM

List items appear on the menu in the order in which they appear in the source file. They are not displayed in alphabetical order.

Each item is automatically assigned an alphabetic selection character.

If you want to assign a different character, place a caret (^) and the character you want in front of the item name (no spaces).



Forcing the selection character shortens the maximum line length to 38 characters.

If you assign selection letters, you should assign them to all menu list items. Otherwise another item may be automatically assigned a character you have previously assigned.

### Example

For example, if the first menu item is “Word Processing” and you want to assign it the letter “W” instead of the automatic letter designation of “A,” type

```
ITEM ^WWord Processing
```

# NMENU Control Commands and Options

Control commands tell NMENU how to perform an action, such as displaying a submenu or user prompt, performing a DOS function, or starting an application. You also use these commands to tell the menu program how to process information and execute commands.

Table D-3 gives an overview of the control commands. Detailed information about each command follows the table.

Table D-3  
NMENU Control Commands

Command	Explanation
EXEC	Executes a DOS or NetWare command following an ITEM statement.
SHOW	Displays a submenu from the same .DAT file.
LOAD	Calls and displays a menu as a submenu from a different .DAT file than the one you are running.
GETO	Requests information from the user before a menu item is executed. User input is <i>optional</i> . (See "GETx (GETO, GETP, GETR)" on page 817.)
GETP	Requests information from the user before a menu item is executed. User input is <i>required</i> for the program to proceed. Assigns a variable (%n) to the information so it can be used again. (See "GETx (GETO, GETP, GETR)" on page 817.)
GETR	Requests information from the user before a menu item is executed. User input is <i>required</i> for the program to proceed. (See "GETx (GETO, GETP, GETR)" on page 817.)

## EXEC

Instructs NMENU to perform the command that follows EXEC.

### Command Format

**EXEC** *command*

Replace *command* with the command required to execute the ITEM. This could be the name of an executable file, a DOS or NetWare command, or one of the options associated with EXEC. The EXEC options are described in Table D-4.

Table D-4  
EXEC Command Options

EXEC Option	Explanation
EXEC CALL	Runs a batch file, and returns to NMENU. If you want to return to NMENU after a batch file executes, use this command to call batch files.
EXEC DOS	Runs the DOS command processor. If this command is used, the menu user must type "EXIT" when DOS processing is completed in order to return to NMENU.
EXEC EXIT	Exits the user from NMENU, but leaves the user logged in to NetWare. For security reasons, users cannot access the NetWare prompt unless this command is included in the menu.
EXEC LOGOUT	Exits the user from NMENU and logs the user out of the network, leaving the user at the DOS prompt. (See "Setting Up the User Environment" on page 823.)

### Using EXEC

EXEC must follow the ITEM it applies to. It must also follow other control commands needed by ITEM.

## Example

To load Word 5.0 from a menu, include the two following lines in the menu file:

```
ITEM Word 5.0
    EXEC word5
```

## LOAD

Instructs NMENU to execute a separate menu file.

### Command Format

```
LOAD filename
```

Replace *filename* with the name of another NMENU program.

If you have several menu programs created with the .DAT extension, use this command to call another menu program from the active menu program. LOAD always calls menus by their filename, not number.

### Using LOAD

Use this command when you have multiple menu programs defined. Although you can define up to 255 menus per source file, smaller, separate files are easier to manage and update.

The NMENU file being loaded must be in the current directory, or you must have a search path to the file defined.

## Example

If you are writing a menu program for Sales and you want to call up the Accounting menu program, type

```
MENU 1,Sales Main Menu
    ITEM Accounting Menu
    LOAD ACCOUNT
```

## SHOW

Instructs NMENU to execute a submenu defined within the same file.

### Command Format

```
SHOW menu_number
```

Replace *menu\_number* with the number of the submenu to be displayed.

### Using SHOW

Include SHOW commands to identify the submenu to be displayed when an item is selected from a menu.

SHOW commands always use menu numbers, not titles.

### Example

If you have a menu with items listing categories of applications such as “Word Processing” and “Spreadsheets,” each ITEM has the following SHOW commands to call up the appropriate submenus for those categories:

```
ITEM Word Processing
    SHOW 3
ITEM Spreadsheets
    SHOW 5
```

To continue this example, if menu “3,Word Processing” is a list of available word processing programs needed by both Sales and Accounting, and each group has its own menus defined, the programs can “share” that screen and the screen’s calls to execute the applications.

## GET<sub>x</sub> (GETO, GETP, GETR)

The GET<sub>x</sub> commands provide access to user input. You can request or require user input. You can even store user input for future use. Each variation of the GET<sub>x</sub> command uses the same parameters to control what the users sees and does. Pay close attention to the use of spaces, commas, and braces {}.

### Command Format

```
GETx prompt {prepend} length, [prefill], {append}
```

Replace *x* with the letter “O,” “R,” or “P.”

- ◆ If you want the user to decide whether to enter information, use GETO.
- ◆ If you want to require the user to enter information (such as a password), use GETR.
- ◆ If you want user input to be used by more than one EXEC command after it is entered, use GETP. The information is assigned a variable (such as %1, %2, etc.).

Replace *prompt* with the text (instructions) to be displayed to the user (40 characters maximum). For example: “Enter your Password.”

*Prepend* is a value added to the beginning of the user response. A space is usually required in the first GET<sub>x</sub> command, to separate it from the command issued in its associated EXEC command.

Replace *length* with the maximum number of characters the user can enter. This parameter is required. For example, if you use GETR for a phone number, limit the *length* to 11 characters to match the field length for the phone number. Or, if you want a state or country abbreviation entered, limit the *length* to two characters.

Replace *prefill* with a default response displayed with the *prompt*. The user can accept the default, change the response by typing over the default, or cancel selection of the item. *Prefill* cannot be longer than the specified *length*.

The *prefill* parameter is optional. If you do not want to include a default response, enter the two commas together. (See the GETx examples on the following page.)

*Append* is the value added to the end of the user response. If no value is needed, enter braces with a blank space between them.



Append doesn't work with GETP.

### Using GETx Interactive Commands

Following are some general guidelines on the use of the GETx commands.

- ◆ You must define commands for each menu ITEM separately.
- ◆ Enter commands between the ITEM and the EXEC command(s) associated with the ITEM.
- ◆ Enter the commands in either uppercase or lowercase.
- ◆ Limit each prompt to one line.



## GETx Command Examples

- ◆ Assume that you want to require users to enter a project code to keep track of work performed for that project. Type the following:

```
GETR Please enter the project code: { } 08,, { }
GETR Please enter your password: { } 08,, { }
GETO Load default macros? { } 01,, { }
```

- ◆ To get input for a program that calculates mortgages, using GETR, type

```
GETR Enter the loan amount: { } 7,,{ }
GETR Enter the interest rate: { } 5,8.5, { }
GETO Enter the period (/m=months or /y=years):+
    { } 7,/y=30, { }
EXEC mortgage
```

The input values will be appended to the “EXEC mortgage” command before it is executed.

To create the previous program using GETP in place of other GET commands, type

```
GETP Enter the loan amount: { } 7,,{ }
GETP Enter the interest rate: { } 5,8.5, { }
GETP Optional-Enter the period (/m=months or+
    /y=years): { } 7,/y=30, { }
EXEC echo %1
EXEC echo %2
EXEC echo %3
EXEC mortgage %1 %2 %3
EXEC pause
```

# Creating a Menu File

Checklist



## Prerequisites

- A workstation running DOS 3.30 or later
- The Read, File Scan, Write, Create, and Erase file system rights to the directory where you will create and edit the menu
- A DOS text editor

## Example Menu Programs

Study the following examples by creating and trying them. By entering, executing, and debugging each example, you will gain the depth of understanding necessary to use the scripting language effectively.

Note



In the following examples, indents are used to help readability; they are not required.

The examples include those script files used for the menus in Figure D-1, Figure D-3, Figure D-5, and Figure D-6. Subsequent examples show other ways of using the NMENU scripting language.

### Example 1: Single-Window Menu

This example in the following figure is the text used to create the menu in Figure D-1 on page 801.

**Figure D-7**  
**Single-Window**  
**Menu Script**

```
Menu 1,Title Bar
  Item One {pause}
    Exec dir
  Item Two {show pause}
    Exec ver
  Item ^XExit
    Exec EXIT
```

## Example 2: A Simple Menu

Text from the .SRC file used for the menu in Figure D-5 is shown in the following figure. This menu demonstrates how submenus can be used.

**Figure D-8**  
**A Simple Menu**  
**Script**

```
Menu 5,Available Applications
  Item Word Processors { }
    Show 10
  Item SpreadSheets { }
    Show 15
  Item ^XExit Menu { }
    Exec EXIT
Menu 10,Available Word Processors
  Item WordPerfect 5.1
    Exec wp51
  Item WordPerfect 6
    Exec wp6
  Item MSWord
    Exec Word
Menu 15,Available SpreadSheets
  Item Quattro Pro
    Exec Q
  Item Lotus 123
    Exec 123
```

## Example 3: A More Complex Menu

The menu in Figure D-6 was created from the text file in the following figure. This menu incorporates the GETR command with simple DOS functionality.

**Figure D-9**  
**A More Complex**  
**Menu Script**

```
menu 22,Data Entry
  item ^AAdd Entry to Catalogue {show}
    getr Enter Title { } 40,, {, }
    getr Enter Author's Name { } 40,, {, }
    getr Category: 1=Apps, 2=Prod, 3=Self { } 1,, {,}
    exec echo >>datalist.cat
  item ^View Catalogue {pause}
    exec sort <datalist.cat | more
  item ^Instructions {pause}
    exec type instruct.cat | more
  item ^XExit the menu
    exec EXIT
```

As this menu script shows, by combining regular DOS commands with special MMENU conventions you have a simple means of organizing data. You don't need a database program just to catalog some information.

#### Example 4: Combining DOS and NetWare Commands

Users can accomplish more work when access to DOS and NetWare functionality is combined in the same menu.

**Figure D-10**  
**Combining**  
**Commands in a**  
**Script**

```
Menu 01,User Options
  Item Utilities
    Show 10
  Item DOS Prompt
    Exec DOS
  Item Log out of the network
    Exec Logout
Menu 10,Utilities
  Item ^1NetWare Menu Utilities
    Show 12
  Item ^2NetWare Command Line Utilities
    Show 14
Menu 12,NetWare Menu Utilities
  Item NETADMIN {Batch}
    Exec netadmin
  Item FILER {Batch}
    Exec filer
  Item NETUSER {Batch}
    Exec netuser
Menu 14,NetWare Command Line Utilities
  Item NLIST {show}
    Geto Class & Option: { } 25,user /a, {}
    Exec nlist
  Item COPY Files {pause}
    Getp Enter Source { } 25,, {}
    Getp Enter Destination { } 25,, {}
    Exec ncopy %1 %2
    Exec dir %2 /w
  Item Display a MAP listing {show pause}
    Exec map
```

In Menu 14 from Example 5, the DIR command uses the same variable as the NCOPY command immediately above it. The {pause} option allows the results to be viewed as long as necessary.

## Making Menus Work

Now that you have working menus, you must make them available to your users. Following is a list of rules for usage.

- ◆ You must create a search drive to the directory where the menu files exist. Search mappings can be created in container, profile, or user login scripts.
- ◆ Users must have at least Read and File Scan rights to the directory where the menu files exist.
- ◆ NMENU uses temporary files. You must create a permanent drive mapping assignment to a directory where the temporary files will be used.
- ◆ Users must have at least Read, File Scan, Write, Create, and Erase rights to the directory where the temporary files will be stored.

You can simplify management of the menu system by keeping all menu files in one place, such as SYS:MENUS. It becomes even easier to manage if the temporary files are kept in one place, such as SYS:MENUS\TEMP.

## Setting Up the User Environment

If you are storing users' temporary files in a network directory, place the following commands in the login script:

```
SET S_FILEDIR=
SET S_FILE=.
```

For example, if you have created a subdirectory called TEMP under a MENU directory, you would type

```
SET S_FILEDIR="Z:\\MENUS\\TEMP\\"
SET S_FILE="%STATION"
```

These commands point to the directory where temporary files are stored and create unique files in the temporary directory for each workstation ID number. The trailing backslash on the S\_FILEDIR path is required.



If you choose not to use the %STATION identifier variable, you must manually create a file with a maximum length of seven characters. The NMENU program automatically prepends the # symbol to the beginning of the S\_FILE filename.

If the user will be using a menu with the logout option, set the S\_FILEDIR environment variable to a path on the user's local drive. Set the S\_FILE to "%STATION."

A copy of the MENU-X.BAT file needs to be in the SYS:LOGIN directory if the NMENU LOGOUT option is going to be used.

EXEC LOGOUT gives the message "Batch file not found" unless the temporary directory is on a local drive, and MENU\_X.BAT is in the LOGIN directory.

### **Starting NMENU from a Login Script**

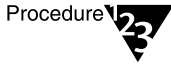
If you want the menu to execute from within a login script, add the EXIT login script command. For example, to execute the ACCOUNT menu from a user's login script, add the following line to the login script:

```
EXIT "NMENU ACCOUNT"
```

# Converting Old Menu Files

Use this procedure to convert an existing MENU file (created with an earlier version of NetWare) to an NMENU file. These older menu programs usually have the extension .MNU.

## Procedure



### 1. Create a directory for the new menu files and temporary files.

If you want to use the directories you already have set up for menu programs, you do not need to create new ones.

#### 1a. Change the old .MNU file to the new .SRC source file format with the MENU CNVT command. Complete the following steps.

#### 1b. At the workstation command line, type

```
MENUCNVT menu_name.mnu <Enter>
```

Replace *menu\_name* with the name of the old menu you want to convert. If the menu is not in your current directory, enter the complete path to the menu name.

The program creates a new .SRC file, leaving the original .MNU file unchanged.

#### 1c. Edit the new menu source file.

You will probably need to edit the new file to eliminate incorrect commands. For example, if your original MENU file used the SYSCON command, you must remove it from your new NMENU file and replace it with an appropriate NetWare 4 command (such as NETADMIN or NETUSER). NetWare 4 does not use SYSCON.

There can be substantial differences between the original .MNU file and the converted .SRC file. MENU CNVT takes care of most differences, but not all of them. Some typical entries requiring changes by hand include the following:

- ◆ Invalid commands such as SYSCON
- ◆ Preceding letters or numbers from the old menu
- ◆ Conversion of former @1, @2, etc., variables into the newer GETP variables

2. Follow the same six steps discussed in “Menu Creation Steps” on page 804.

### Example

To help you see the differences between MENU and NMENU files, Figure D-11 shows a part of the file for the menu in Figure D-3 on page 803.

The figure shows both the .MNU and the unedited .SRC file formats. They are shown side-by-side to help you make the comparison.

The “After Conversion (.SRC)” side has not yet been edited. Try to find changes to make the file execute properly and efficiently. Look for commands that are no longer supported in NetWare 4 and replace them with appropriate commands. One example is SLIST, which must be replaced with NLIST SERVER.

If you create your own file to test the .SRC file, remember to create some text file(s) to be displayed by the TYPE command.

**Figure D-11**  
**Conversion Scripts**

#### Before Conversion (.MNU)

```
%Questions Questions Questions!,12,20,2
1. Who Am I?
   whoami
   pause
2. Where Am I?
   type where.txt
   pause
3. Am I Alone?
   userlist
   pause
4. What Am I Doing Here?
   type what.txt
   pause
5. What Can I Do?
   %Your Choice
6. What Next?
   %What Next
```

#### After Conversion (.SRC)

```
MENU 01,Questions Questions Questions!
ITEM Who Am I? { }
EXEC whoami
EXEC pause
ITEM Where Am I? { }
EXEC type where.txt
EXEC pause
ITEM Am I Alone? { }
EXEC userlist
EXEC pause
ITEM What Am I Doing Here? { }
EXEC type what.txt
EXEC pause
ITEM What Can I Do? { }
SHOW 02
ITEM What Next? { }
SHOW 03
```



(continued)

**Before Conversion (.MNU)**

```
%Your Choice,5,50,4
A. Quit
    leave.bat
B. Try Again
    %Utilities
C. Experiment
    %Demo

%Demo,12,40,1
1. CHOICE 1
    %Utility
2. CHOICE 2
    %Variety
3. CHOICE 3
    %TalkToMe
4. CHOICE 4
    %Beyond

%Beyond,20,75,5
MOVE ABOUT
    %Pop_up_1
THE OUTSIDE WORLD
    slist
    pause

%Pop_up_1,24,10,6
MOVE ABOUT
    %Pop_up_2

%Pop_up_2,19,30,1
MOVE ABOUT
    %Pop_up_3

%Pop_up_3,1,1,2
MOVE ABOUT
    %Pop_up_4

%Pop_up_4,8,60,3
MOVE ABOUT
    %Pop_up_5

%Pop_up_5,12,4,4
MOVE ABOUT
    %Pop_up_6

%Pop_up_6,12,78,5
MOVE ABOUT
    type theend.txt
    pause
```

**After Conversion (.SRC)**

```
MENU 02,Your Choice
    ITEM Quit { }
        EXEC leave.bat
    ITEM Try Again { }
        SHOW 06
    ITEM Experiment { }
        SHOW 07

MENU 07,Demo
    ITEM CHOICE 1 { }
        SHOW 08
    ITEM CHOICE 2 { }
        SHOW 09
    ITEM CHOICE 3 { }
        SHOW 10
    ITEM CHOICE 4 { }
        SHOW 11

MENU 11,BEYOND
    ITEM MOVE ABOUT { }
        SHOW 12
    ITEM THE OUTSIDE WORLD { }
        EXEC SLIST
        EXEC PAUSE

MENU 12,Pop_up_1
    ITEM MOVE ABOUT { }
        SHOW 13

MENU 13,Pop_up_2
    ITEM MOVE ABOUT { }
        SHOW 14

MENU 14,Pop_up_3
    ITEM MOVE ABOUT { }
        SHOW 15

MENU 15,Pop_up_4
    ITEM MOVE ABOUT { }
        SHOW 16

MENU 16,Pop_up_5
    ITEM MOVE ABOUT { }
        SHOW 13

MENU 12,Pop_up_6
    ITEM MOVE ABOUT { }
        EXEC TYPE THEEND.TXT
        EXEC PAUSE
```



# Trademarks

## Novell Trademarks

Client 32 is a trademark of Novell, Inc.

DR DOS is a registered trademark of Novell, Inc. in the United States and other countries.

GroupWise is a trademark of Novell, Inc.

Hot Fix is a trademark of Novell, Inc.

Internetwork Packet Exchange and IPX are trademarks of Novell, Inc.

LANalyzer is a registered trademark of Novell, Inc. in the United States and other countries.

Media Support Module and MSM are trademarks of Novell, Inc.

NE/2 is a trademark of Novell, Inc.

NE/2-32 is a trademark of Novell, Inc.

NE1000 is a trademark of Novell, Inc.

NE2000 is a trademark of Novell, Inc.

NE2100 is a trademark of Novell, Inc.

NE3200 is a trademark of Novell, Inc.

NE32HUB is a trademark of Novell, Inc.

NetWare is a registered trademark of Novell, Inc. in the United States and other countries.

NetWare 3 is a trademark of Novell, Inc.

NetWare 4 is a trademark of Novell, Inc.

NetWare 4.1 SFT III is a trademark of Novell, Inc.

NetWare Application Launcher is a trademark of Novell, Inc.

NetWare Application Manager is a trademark of Novell, Inc.

NetWare Application Notes is a trademark of Novell, Inc.

NetWare Care is a trademark of Novell, Inc.

NetWare Core Protocol and NCP are trademarks of Novell, Inc.

NetWare DOS Requester and NDR are trademarks of Novell, Inc.

NetWare Link Services Protocol and NLSP are trademarks of Novell, Inc.

NetWare Loadable Module and NLM are trademarks of Novell, Inc.  
NetWare Message Handling Service and NetWare MHS are trademarks of Novell, Inc.  
NetWare Peripheral Architecture and NPA are trademarks of Novell, Inc.  
NetWare Requester is a trademark of Novell, Inc.  
NetWare Storage Management Services and NetWare SMS are trademarks of Novell, Inc.  
NetWire is a service mark of Novell, Inc.  
Novell is a registered trademark of Novell, Inc. in the United States and other countries.  
Novell Authorized Reseller is a service mark of Novell, Inc.  
Novell Directory Services and NDS are trademarks of Novell, Inc.  
Novell Labs is a trademark of Novell, Inc.  
NSEPro is a trademark of Novell, Inc.  
ODI (Open Data-Link Interface) is a trademark of Novell, Inc.  
Personal NetWare is a trademark of Novell, Inc.  
RX-Net is a trademark of Novell, Inc.  
RX-Net/2 is a trademark of Novell, Inc.  
SFT (System Fault Tolerant) and SFT III are trademarks of Novell, Inc.  
SPX is a trademark of Novell, Inc.  
Storage Management Services and SMS are trademarks of Novell, Inc.  
The Novell Network Symbol is a trademark of Novell, Inc.  
Transaction Tracking System and TTS are trademarks of Novell, Inc.

## **Third-Party Trademarks**

Adaptec is a registered trademark of Adaptec, Inc.  
Apple and AppleTalk are registered trademarks of Apple Computer, Inc.  
ARCnet is a registered trademark of Datapoint Corporation.  
AT&T is a registered trademark of AT&T Corp.  
COMPAQ is a registered trademark of Compaq Computer Corporation.  
CompuServe is a registered trademark of CompuServe Incorporated.  
DynaText is a registered trademark of Electronic Book Technologies, Inc.  
Hayes is a registered trademark of Hayes Microcomputer Products, Inc.

Hewlett Packard is a registered trademark of Hewlett-Packard Company.

IBM is a registered trademark of International Business Machines Corporation.

Lotus and Lotus 1-2-3 are registered trademarks of Lotus Development Corporation.

Macintosh is a registered trademark of Apple Computer, Inc.

Microsoft is a registered trademark of Microsoft Corporation.

MS-DOS is a registered trademark of Microsoft Corporation.

NFS is a registered trademark of Sun Microsystems, Inc.

OS/2 is a registered trademark of International Business Machines Corporation.

PS/2 is a registered trademark of International Business Machines Corporation.

Quattro Pro is a registered trademark of Corel Corporation Limited.

Unicode is a registered trademark of Transoft Ltd.

UNIX is a registered trademark of X/Open Company, Ltd., in the United States and other countries.

Word is a registered trademark of Microsoft Corporation.

Windows is a registered trademark of Microsoft Corporation.

Windows 95 is a trademark of Microsoft Corporation.

Windows NT is a trademark of Microsoft Corporation.

WordPerfect is a registered trademark of Corel Corporation Limited.

XT is a trademark of International Business Machines Corporation.



# Index

- # login script command, using 188
- %n identifier variable, using to shift LOGIN parameters 228, 239
- \* character, using in login scripts 223
- .DAT file for menus 804
- ; character, using in login scripts 223
- <variable> identifier variable, explained 237

## A

- Abends, resolving 707
- Aborting partition operation
  - explained 306
  - with PARTMGR 307
- Access server, checking for, in login scripts 237
- ACCESS\_SERVER identifier variable, explained 237
- Account expiration date, changing 88, 93
- Account Restrictions property, setting with NETADMIN 93
- Account, ADMIN, unlocking 431
- Accounting
  - calculating charge rates for 560
  - setting up 558, 559
  - viewing totals 561
- ACTIVATE SERVER utility, deleting from IOSTART.NCF file 788
- ADD NAME SPACE utility, using 476
- Add or Delete Self property right, explained 13. *See also* Rights, property
- Address
  - node, specifying in login scripts 236
  - postal, changing 89, 94
  - workstation network, specifying in login scripts 236
- ADMIN User object
  - default location in Directory tree 3
  - default login script, executing 240
  - default rights, listed 3
  - rights available to 9
  - unlocking account 431
- Administration utilities, setting up 5
- AFP Server object, explained 27
- AIO port interface module, loading 546
- AIOCOMX communications port driver, loading 534, 546
- Alerts
  - displaying on server console 460
  - full volume 462
  - hardware and NLM, turning on 460
  - insufficient disk space for compression 498
  - insufficient memory, handling 440
  - turning off 460
  - viewing in server error log 463
- Alias object
  - creating after moving container 68
  - creating when renaming Container object 83
  - deleting 80
  - explained 27
- Allocating memory in NetWare Server for OS/2 762

- Alternate MSL boards, installing 772
- AM\_PM identifier variable, explained 235
- Appending backup sessions 675
- Application
  - assigning trustee rights to 117
  - failure due to insufficient locks 458
  - guidelines for installing on network 116
  - installing on network 109
  - mapping fake root in login scripts 212
  - mapping fake root to, examples 218
- Application management software, setting up and using 123
- Application object
  - creating and using 129
  - explained 28
- Archive Needed attribute, using with SBACKUP 623
- ASCII file. *See* Text file
- Asterisk, using in login scripts 223
- Asynchronous connection
  - explained 539
  - NLM for remote console 546
- ATOTAL utility, using 561
- ATTACH login script command, using 189
- Attributes, directory. *See also* Attributes, file
  - modifying with FILER 149
  - modifying with NetWare Administrator 148
- Attributes, file. *See also* Attributes, directory
  - displaying, with FILER 493
  - explained 134
  - modify bit (Archive Needed), using with SBACKUP 623
  - modifying 148, 149
- Auditing File object, explained 28
- AUTO RESTART AFTER ABEND DELAY TIME parameter 712
- AUTO RESTART AFTER ABEND parameter 708

- AUTOEXEC.BAT file, executing
  - SERVER.EXE in 556
- AUTOEXEC.NCF file
  - creating or editing 416
  - file compression SET parameters in 497
  - internal network number in 430
  - SCHDELAY command in 445
  - server name in 430

## B

- Backup
  - files, explained 596
  - hardware upgrade, planning 283
  - NetWare Server for OS/2 767
  - prerequisites 613
  - procedures 613
  - SBACKUP utility, using 594
  - target, missing from SBACKUP list 614
  - troubleshooting 680
  - types of, explained 596
  - verifying data 667
- Backup administrators
  - assigning 607
- Backup devices
  - checking status of 671
  - defined 593
  - renaming 674
  - supported 593
- Backup log
  - default directory 615, 638, 659
  - defined 659
- Backup media
  - amount required 675
  - checking status of 671
  - labeling 675
  - numbers, incrementing 675
  - out of space, handling 675
  - spanning 675
  - utilities, using 673



- Backup MSL. *See* Alternate MSL boards, installing
- Backup power. *See* UPS monitoring
- Backup session
  - log and error files, deleting 667
  - logbook, maintaining hard-copy 601
  - overwriting sessions on media 666
  - scheduling 602
  - subsets, choosing 597
- Backup type
  - custom 596
  - differential 597
  - full 596
  - incremental 597
- Backup types
  - effect on restore sessions 602
  - explained 596
- Backwards compatibility, monitoring and maintaining 290
- Batch file. *See also* AUTOEXEC.BAT file; AUTOEXEC.NCF file; STARTUP.NCF file
  - adding search path for server, creating or editing
- BATCH option for ITEM menu command, explained 810
- Battery power. *See* UPS monitoring
- Bindery context, setting 290
- Bindery services
  - maintaining 290
  - rules for naming objects viewed through 34
- Bindery. *See* Directory tree
- Binding LAN drivers 407
- Block suballocation on CD-ROM volume 483
- Blocks
  - viewing redirected 467
- Booting
  - remote server 556
  - with EXIT command 556

- Bottlenecks, avoiding server 437
- BREAK login script command
  - using 190
  - using with GOTO 202
- Browse object right, explained 11. *See also* Rights, object
- Buffers
  - cache, reporting low 460
  - cache, troubleshooting 734
  - controlling with SET 679
  - directory, troubleshooting 734
  - packet receive, troubleshooting 731, 732

## C

- Cabling
  - resolving problems 705
  - troubleshooting 728, 731, 736, 737
- Cache buffer
  - alerts, turning on 460
  - hits, tracking 439
  - troubleshooting 734
- Caching
  - directory, changing 451
  - file, changing 461
- Callback list, creating 547
- CD-ROM
  - disk, using as read-only volume 483, 491
  - extracting NetWare files from 414
- CDROM NLM, loading 485
- CD-ROM volume
  - enabling block suballocation 483
  - enabling file compression 483, 491
  - mounting 483
- Certificates
  - license 683, 694
  - metering 695
- Charge rates, accounting, formula 560
- CHDIR option for ITEM menu command, explained 811

- Children of parent directory, for backup or restore
  - explained 600, 648, 651
- CLEAR STATION command, using 432
- CLIB NLM, changing packet signature level for 526
- Client
  - rights, disabling 527
- CLS login script command, using 191
- COMMAND.COM file, specifying location of, in login scripts 191
- Commands
  - executing after stopping login script 198
  - executing from within login scripts 188
  - login script (see Login script commands)
- Comments
  - displaying during login with WRITE 232
  - using in login scripts with REMARK 223
- Communication failures
  - most common causes listed 255
  - resolving 255
- Communication links, monitoring status 254
- Communication problems, troubleshooting 728
- Communications port driver (AIOCOMX), loading 534, 546
- Compaq computer
  - long machine name, specifying in login scripts 210, 236
  - short machine name, specifying in login scripts 236
- Compare property right, explained 12. *See also* Rights, property
- COMPATIBLE login script command. *See* PCCOMPATIBLE login script command
- Compiling menus 804
- Compression, file. *See* File compression
- Computer object, explained 28
- Computer. *See also* Workstation
  - long machine name, specifying in login scripts 210, 236
  - short machine name, specifying in login scripts 236
- COMSPEC login script command
  - using 191
  - using with OS/2 workstations 192
- Conditional statements, using in login scripts 203
- Configuration files for SFT III, explained 773
- Configuring
  - NetWare Server for OS/2 754
  - server products 412
  - server, sample files for 97
  - time synchronization for large networks 273
- Connection number
  - determining workstation 432
  - workstation, specifying in login scripts 236
- Connections to server
  - bottlenecks, resolving 436
  - clearing 431
  - logins, enabling and disabling 431
  - monitoring with watchdog packets 433
  - packet receive buffers, increasing 435, 436
- Console
  - display, changing SFT III 797
  - prompt, changing 779
- Console commands, troubleshooting 717
- Container login script, explained 169
- Container objects
  - explained 16
  - listed 17
  - naming rules for 19
  - property values, changing 87, 91
  - renaming 83
- Container objects, creating
  - with INSTALL 21
  - with NETADMIN 23
  - with NetWare Administrator 22

- Container objects, moving
  - explained 68
  - with NETADMIN 76
  - with NetWare Administrator 71, 74
- CONTEXT login script command, using 193
- Context, name
  - changing, in login scripts 193
  - displaying context user exists in 236
  - displaying context when login started 236
- Controller board, troubleshooting problems
  - with 704
- Conventions, for entering commands xix
- COPY command (DOS), verifying copies, in
  - login scripts 196
- Copy, of Directory partition. *See* Replica
- Copying files
  - from installation diskettes 414
  - NetWare 413
  - verifying copies made with DOS COPY 196
  - with FILER 106
  - with NetWare Administrator 105
- Copying login scripts
  - with NETADMIN 180, 184
  - with NetWare Administrator 183
- Country object, explained 18
- Create object right, explained 11. *See also* Rights, object
- Creating
  - Application objects 131
  - Directory Map objects 119, 121
  - NetWare disk partitions 511
  - volumes 469
- Creating directories
  - HCSS domain 369
  - HCSS media-label 371
  - with FILER 103
  - with NetWare Administrator 101
- Creating Directory partitions
  - with PARTMGR 300

- Creating login scripts
  - with NETADMIN 179
  - with NetWare Administrator 177
- Creating replicas
  - explained 308
  - with PARTMGR 308
- Custom backup. *See* Backup types
- Custom file system backup
  - procedures 621
- CX login script command. *See* CONTEXT login script command

## D

- Data migration. *See also* Optical media
  - creating HCSS domain directories for 369
  - deleting HCSS domain directory 382
  - explained 354
  - formatting for HCSS 375
  - HCSS-compatible hardware 361
  - reformatting optical media for 383
  - reloading optical media in jukebox 381
  - threshold example 354
- Data protection. *See* Security
- Database
  - Directory, repairing 324
  - integrity, protecting (*see* Transaction Tracking System)
- Date
  - server, setting and viewing 428
  - specifying for delayed backup 618
  - specifying in login scripts 235
- DAY identifier variable, explained 235
- DAY\_OF\_WEEK identifier variable, explained 235
- Deadlock, troubleshooting MSL 773
- Decompressing files. *See* File compression
- Default
  - drive, specifying in login scripts 197
  - objects and rights, NetWare 4.11 table 2

- user rights, listed 3
- Default login script. *See also* Login scripts
  - commands in 241
  - explained 170
  - preventing from executing 219
- Default user values. *See* User template.
- Delayed backup
  - security considerations 618
  - setting date and time 618
  - with compressed files 677
- Delete object right, explained 11. *See also* Rights, object
- Delete Self property. *See* Add or Delete Self property
- Deleted files, purging
  - automatically with SERVMAN 499
  - with FILER 167
  - with NetWare Administrator 166
- Deleted files, salvaging
  - with FILER 164
  - with NetWare Administrator 162
- DELETED.SAV directory, explained 97
- Deleting objects
  - cautions 79
  - explained 78
  - with NETADMIN 82
  - with NetWare Administrator 81
- DEVELOPER OPTION parameter 708
- Device, checking for new, on NetWare server 362
- Directory
  - default, specifying in login scripts 197
  - mapping drives in login scripts 210
  - mapping fake root in login scripts 212
  - name space information, viewing 157
  - rights, explained 10
  - searches, improving speed of 442
  - viewing information about 158, 159, 160
- Directory attributes. *See* Attributes, directory
- Directory buffers, troubleshooting 734
- Directory caching
  - changing for faster writes 451
  - controlling 440
  - decreasing 454
  - increasing 442
- Directory Entry Table
  - troubleshooting 725
  - updating with VREPAIR 477
- Directory Map object
  - creating 119, 121, 131
  - explained 29, 118
  - mapping drive in login scripts 216
- Directory partition. *See* Partition, Directory
- Directory security
  - adding trustees 136, 137
  - changing owner 151, 152
  - deleting trustees 139, 140
  - modifying trustee rights 142, 143
  - rights, explained 133 (*see also* Rights; file system)
- Directory Services. *See* NetWare Directory Services
- Directory tree
  - changing name context in login scripts 193
  - configuring time synchronization for 273
  - creating partitions 299 (*see also* Partition, Directory)
  - database, repairing 324
  - example 4
  - example of new 4
  - merging 335
  - moving objects in 68
  - synchronizing two trees 276
- Directory, creating
  - automatically, during installation 97
  - planning guidelines for 97
  - structure, example 100
  - with FILER 103
  - with NetWare Administrator 101
  - workstation operating systems 109

- Directory, default
  - changing for backup log 615, 638
- Directory, deleted
  - purging 166, 167
  - salvaging 162, 164
- Disaster prevention and recovery 519, 706
- Disk drivers
  - loading 508
- Disk duplexing 514
- Disk errors
  - checking for, with MONITOR 466
- Disk mirroring
  - explained 514
  - recovering orphaned partitions 783
- Disk partition. *See* Partition, disk
- Disk reads, improving
  - by changing concurrent disk and directory writes 454
  - by changing turbo FAT Re-Use Wait Time 455
- Disk space
  - assigning to other volumes 470
  - checking, with NDIR 489
  - errors in server, resolving 713
  - errors in workstation, resolving 742
  - increasing, with file compression 490
  - managing server 489
  - required to add volume segment 481
  - required to create volumes 469
  - required to uncompress files 490
  - warning for insufficient 498
- Disk writes, improving
  - by changing disk and directory caching 451
  - by increasing concurrent writes 449
  - by turning off read-after-write verification 453
- Dismounting volume
  - with INSTALL 471
- DISPLAY login script command, using 194
- Distribution List object, explained 29
- Domain directory, creating HCSS for data migration 369, 371
- DOS
  - installing on network 109
  - name space supported by SBACKUP 595
  - text files, editing 418
- DOS in login scripts
  - allowing <Ctrl><Break> 195
  - COMMAND.COM, specifying location of 191
  - directory, mapping search drive to 216
  - DOS BREAK command, using 195
  - DOS COPY command, verifying copies 196
  - DOS VERIFY command, using 196
  - environment variables, setting 224
  - prompt, setting 226
  - type, specifying 236
  - version, specifying 236
- DOS SET login script command. *See* SET login script command
- DOS workstation. *See also* Workstation resolving memory problems 741
- DOS workstation. *See also* Workstation environment variables for, setting in login scripts 224
  - environment variables, setting in login scripts 237
  - non-IBM\_PC, using PCCOMPATIBLE in login scripts 198, 221
  - password option for SBACKUP 625
  - running DOS from network 109
- DOWN utility, using 405
- DRIVE login script command, using 197
- Drive mapping
  - creating, in login scripts 210
  - deleting, in login scripts 212
  - with Directory Map object 118
  - Directory Map object, explained 29

- to fake root, in login scripts 212
- in login scripts, examples 216
- to physical volume, in login scripts 212
- recommended order in login scripts 214
- using with Directory Map object, example 216

Drive, default, specifying in login scripts 197

Drivers. *See* Disk drivers; LAN drivers

DSMERGE utility

- checking servers 340
- checking time synchronization 342
- merging Directory trees with 335
- merging trees 343
- options explained 338
- overview 335
- preparing trees 337
- renaming trees 345

DSREPAIR log file, viewing and editing 253

DSREPAIR utility

- checking replica synchronization 330
- checking time synchronization 264, 328
- error log, viewing and editing 333
- options explained 326
- overview 324
- repairing Directory database with 324
- running unattended 327

DSTRACE utility

- explained 348
- using 348, 349
- using SET parameters 349

Duplexing disks 514

## E

ECB available count errors, handling 435

EDIT NLM

- editing text files from console 419
- function keys listed 420

Editing NET.CFG file for OS/2 765

Effective rights

- trustee 154
- viewing 155

End address for unclaimed memory, setting 777

Environment

- variables (DOS and OS/2), setting in login scripts 224, 237

Error conditions, viewing 253

Error log

- backup, explained 633
- defined 659
- explained 660
- managing 465
- MSEngine, explained 796
- server, viewing 463
- session errors appended to file 663
- TTS, creating 536
- viewing 662

Error messages. *See* Alerts; Disk errors

ERROR\_LEVEL identifier variable, explained 237

ETC directory, explained 97

Ethernet

- workstations, finding SFT III server 784

Ethernet, troubleshooting 738

Event control block errors, resolving 716

Excluding data

- in backups 597
- while including portions 599

EXEC menu command, explained 814

Executable file

- executing after stopping login script 198
- executing from within login script 188

EXIT login script command

- using 198
- using on non-IBM computers 198

Exporting media, HCSS 379

External Entity object, explained 29

External hard disk, adding to server 505. *See also* Hard disk

Extracting NetWare files from installation  
CD-ROM 416

## F

Fake root

- mapping, in login scripts 212
- mapping, in login scripts, examples 218

FAT. *See* File Allocation Table

FDISPLAY login script command, using 199

File Allocation Table (FAT)

- changing turbo FAT re-use wait time 455
- troubleshooting 725
- updating with VREPAIR 477

File attributes. *See* Attributes, file

File caching, controlling 440

File compression

- backing up compressed files 676
- backing up uncompressed files 676
- daily checks for 496, 498
- enabling, on volume 491
- explained 490
- grouping files for 492
- on CD-ROM volume 483, 491
- restoring files to unsupported environment 676
- SET parameters for 497
- setting, for files and directories 492
- suspending 496
- uncompressing files 490

File information

- name space, viewing 157
- size, viewing 157
- viewing 158, 159, 160

File locks, limiting 457

File security. *See also* Rights, file system

- adding trustee 137
- adding trustees 136
- changing owner 151
- changing owner of 152

- deleting trustees 139, 140
- rights, explained 10

File server. *See* NetWare server

File system rights. *See* Rights, file system

File, batch. *See* Batch file

FILE\_SERVER identifier variable, explained  
236

FILER utility. *See* specific task

Files

- database, protecting with TTS 535
- extracting from CD-ROM 414
- NetWare, location of 97
- purging from disk 499
- server batch (.NCF), creating or editing 416
- text, editing 418
- word-processed, displaying during login  
199

Files, copying

- NetWare 413
- with FILER 106
- with NetWare Administrator 104

Filter. *See* Inherited Rights Filter

FIRE PHASERS login script command, using  
200

FLAG utility, using to change file  
compression attributes 492

Formatting

- optical media for HCSS 375

Formula

- accounting charge rates 560
- name space memory requirements 475

Frame type, troubleshooting 728, 731

FTAM, name space supported by SBACKUP  
595

Full volume alerts, setting 462

FULL\_NAME identifier variable, explained  
235

## G

- GETP menu command, variables 819
- GETx menu command, using 818
- GOTO login script command, using 202
- GREETING\_TIME identifier variable,  
explained 235

### Group object

- adding members 43, 44
- deleting members 49, 50
- explained 30
- giving rights to file system 45, 47
- managing User objects as Group 40
- specifying in login scripts 236

## H

### Hard disk

- failure, resolving 285
- troubleshooting 723

### Hard disk space. *See* Disk space

### Hard disk. *See also* Disk drivers

- adding SCSI to subsystem 505
- internal IDE, adding 502
- internal SCSI disk and adapter, adding 503
- mirroring, explained 514
- out of sync, recovering 537
- replacing 506
- unmirroring, explained 517

### Hardware

- checking for new, on NetWare server 362
- upgrade, preparing 283

### HCSS media

- assigning to directories 377
- checking status 384
- exporting 380
- formatting 375
- importing 372
- reformatting 383

- reloading 381

### HCSS parameters

- explained 384
- methods of modifying 390
- setting, at server console 397
- setting, using NetWare Administrator 391

### HCSS. *See* High Capacity Storage System (HCSS)

### High Capacity Storage System (HCSS)

- creating volume 362
- deleting domain directories 382
- explained 98
- file system structure 352
- hardware, installing compatible 361
- limitations 357
- loading on server 364
- managing file system, procedures 378
- overview 358
- setting up file system 369
- setting up workstation 365, 367

### High-speed link. *See* Mirrored server link (MSL)

### Hot Fix Redirection Area, viewing blocks with MONITOR 467

### HOUR identifier variable, explained 235

### HOUR24 identifier variable, explained 235

### HPFS files, removing name space for 477

## I

### I/O errors, resolving

- event control block allocation 716
- file 715
- server 712
- volume 716

### I'm alive packets, troubleshooting SFT III 792

### IBM computer. *See also* Non-IBM computer; Workstation

- compatible with, specifying in login scripts
- long name, specifying in login scripts



- short name, specifying in login scripts
- IDE disk. *See* Hard disk
- Identifier variables
  - %n, explained 239
  - %n, shifting LOGIN parameters with SHIFT 228
  - conventions in login scripts 176
  - displaying value during login, with WRITE 232
  - examples 238
  - listed 235
  - using 238
  - using with IF...THEN 203
- IF...THEN login script command
  - using 203
  - using with identifier variables 203, 238
- Importing
  - media, HCSS 372
- INCLUDE login script command, using 206
- Including data
  - in backups 598
  - while excluding portions 599
- Incomplete transactions, backing out of 535
- Inherited Rights Filter (IRF), viewing and modifying 145, 146
- INSTALL NLM
  - adding volume segment 481
  - changing internal network number 430
  - changing server name 430
  - changing volume size 482
  - copying files 413
  - creating disk partitions 511
  - creating volume 468
  - deleting disk partitions 513
  - deleting volume 472
  - dismounting volume 471
  - editing NCF files 416
  - installing NetWare Symmetric MultiProcessing 565
  - installing, uninstalling, and configuring server products 412
  - loading disk drivers 508
  - loading LAN drivers 407
  - mirroring disks 514
  - mounting volume 471
  - recovering out-of-sync hard disks 538
  - renaming volume 474
  - unmirroring disks 517
- INSTALL utility
  - removing NetWare Directory Services using (caution) 281
- Installation CD-ROM, extracting files from 414
- Intruder Detection property, changing 89, 93
- IOSLOG.ERR file, limiting size of 779
- IOAUTO.NCF file, explained 773
- IOEngine
  - capturing console messages 778
  - log file, limiting size of 779
  - network number, troubleshooting 790
- IOSTART.NCF file
  - explained 773
  - setting test options in 797
- IPX external network number
  - troubleshooting 732
- IPX internal network number
  - changing 430
  - troubleshooting 732, 790
- IPX protocol
  - binding to 407
  - troubleshooting 731
- IRF. *See* Inherited Rights Filter (IRF)
- ITEM command options
  - BATCH, explained 810
  - CHDIR, explained 811
  - listed 810
  - PAUSE, explained 811
  - SHOW, explained 811

## J

Job servers, packet signature considerations  
for 526

Joining Directory trees with DSMERGE 335

## K

Kernels, NetWare Symmetric  
MultiProcessing 568

KEYB NLM, using 426

Keyboard, setting language for 426

## L

Lab testing, software and hardware 250

LAN drivers

increasing available memory for 705

loading and binding 407

statistics for 447

LAN Support (IBM), troubleshooting 740

Language

changing server language 423

copying language files to server 421

setting, for NLMs 425

setting, for server keyboard 426

LANGUAGE utility, using 426

LAST\_NAME identifier variable, explained  
235

LASTLOGINTIME login script command,  
using 209

Leaf objects

changing property values 88, 93

deleting 81, 82

explained 26

listed 27

mandatory fields when creating 37

naming rules for 33

renaming 83

Leaf objects, creating

explained 26

with NETADMIN 37

with NetWare Administrator 36

Leaf objects, moving

with NETADMIN 72

with NetWare Administrator 69, 71

with NetWare Administrator (drag and  
drop) 71

License Certificate object

explained 30, 690, 694

installing 695

License certificates

assigning to 699

client access 690

explained 694

information, viewing 698

installing 695

new owner, assigning 700

types 694

unassigning 700

License Service Providers, explained 685

Licensed Product object

explained 19, 694

information, viewing 697

installing 695

Licenses

assigning 699

license certificate information, viewing 698

licensed product information, viewing 697

unassigning 700

Licensing Services API, explained 683

Licensing services. *See* NetWare Licensing  
Services

Licensing, software

explained 683

NetWare Licensing Services 684

NLS clients 686

Links, UNIX

error restoring 663

- retained by SBACKUP 661
- LOAD menu command, explained 815
- LOAD utility. *See* Loading drivers; Loading NLMs
- Loader errors, SFT III (troubleshooting) 779
- Loading
  - NetWare Server for OS/2 744
  - network applications, guidelines for 109
- Loading Backup Drivers
  - procedure 610
- Loading drivers
  - device, backup 610
  - device, controller 361, 610
  - device, optical media storage 361
  - disk 508
  - LAN 407
- Loading HCSS
  - drivers 361
  - on server 364
- Loading NLMs
  - determining protection domain for 406
  - procedure 406
  - setting language for 425
- Loading SBACKUP files
  - for servers 612
  - for SFT III 627
  - for workstations 624
  - summary table 611
- Lock. *See* Mutual exclusion lock (mutex)
- Locked ADMIN user account, enabling 431
- Locked device errors, resolving 715
- Locks, file and record, increasing 458
- Log file
  - restore, changing directory or path 638, 639
  - server, viewing 463
  - TTS, creating 536
- Log file, backup
  - changing directory or path 615
  - deleting overwritten sessions from 666
  - explained 659, 660
- Logging in
  - attaching to server from login script 189
  - changing name context in login scripts 193
  - enabling and disabling 431
  - last time of, displaying during login 209
  - to backup target 615, 637
- Login script commands
  - # (executing commands) 188
  - ATTACH (attaching to servers) 189
  - CLS (clearing screen) 191
  - CONTEXT (changing context) 193
  - DISPLAY (displaying text file) 194
  - DRIVE (specifying default drive) 197
  - FDISPLAY (displaying word-processed file) 199
  - IF...THEN (executing conditional action) 203
  - INCLUDE (executing subscript) 206
  - LASTLOGINTIME (displaying time of last login) 209
  - MACHINE (sets DOS machine name) 210
  - MAP (mapping drives and search drives) 210
  - NO\_DEFAULT (preventing default script) 219
  - NOSWAP (preventing memory swapping) 220
  - PAUSE (pausing login script execution) 221
  - PCCOMPATIBLE (specifying non-IBM computers) 221
  - REMARK (inserting comments) 223
  - SET\_TIME (synchronizing with server) 227
  - SHIFT (shifting LOGIN parameters) 228
  - SWAP (swapping memory) 230
  - WRITE (displaying messages) 232
- Login Script property
  - changing with NETADMIN 93

- changing with NetWare Administrator 89
- Login scripts
  - commands and variables, listed 187
  - container, example 242
  - conventions, listed 175
  - default, explained 170
  - default, preventing execution of 219
  - examples 240
  - executing one script as part of another 206
  - exiting to menu from 198, 824
  - explained 169
  - hints for using 175
  - identifier variables, conventions 176
  - identifier variables, listed 235
  - identifier variables, using 234
  - location of, explained 172
  - objects that contain, listed 171
  - previous NetWare versions, using 173
  - profile, explained 170
  - profile, sample 245
  - types, explained 169
  - user, explained 170
  - user, sample 246
- Login scripts, creating
  - command syntax 187
  - copying 180, 183, 184
  - examples 240
  - planning 171
  - profile, assigning user to 178, 183
  - rules 175
  - upgrading from previous versions 173
    - with NETADMIN 179
    - with NetWare Administrator 177
- Login scripts, mapping drives
  - command format 210
  - to Windows directories 114
  - with Directory Map object 118
- LOGIN utility parameters, shifting with %n in login scripts 228

- LOGIN\_CONTEXT identifier variable, explained 236
- LOGIN\_NAME identifier variable, explained 236
- Long machine name. *See also* Machine name non-IBM\_PC, using PCCOMPATIBLE with 198
  - specifying in login scripts 210, 236
- Lost interrupt alerts, troubleshooting SFT III 778
- LSAPI, explained 683
- LSP Server object
  - explained 30, 686
  - information, viewing 701
- LSPs (License Service Providers), explained 685

## M

- MACHINE identifier variable, explained 236.
  - See also* Machine name
- MACHINE login script command, using 210
- Machine name
  - long, specifying in login scripts 210, 236
  - non-IBM\_PC, using PCCOMPATIBLE with 198
- Macintosh files
  - adding name space for 475
  - name space supported by SBACKUP 595
  - removing name space for 477
  - viewing information about 158, 159, 160
- MAIL directory, explained 97
- Maintaining
  - backwards compatibility 290
  - Directory tree with NetWare utilities 249
  - network communication 254
  - network data 289
  - network hardware 278
  - replica synchronization 256
  - time synchronization 262

- Maintenance tools, identifying 251
- Managing NetWare Server for OS/2 743
- MAP login script command
  - examples 216
  - using 210
- Map object. *See* Directory Map object
- Mapping drives. *See* Drive mapping
- Master replica. *See also* Replica
  - explained 296
- MAU, troubleshooting 741
- Media
  - magneto-optical (HCSS), labeling 353
  - status, HCSS 384
- Media utilities
  - erasing all data on media 673
  - erasing media header 673
  - retensioning tape 674
- MEMBER OF "group" identifier variable,
  - explained 236
- Memory
  - requirements for SBACKUP 595
- MEMORY MAP utility
  - displaying unclaimed memory with 777
  - sample display 777
- Memory sharing. *See* NetWare Server for OS/2
- Memory, NetWare Server for OS/2
  - allocating 762
  - freeing 752
  - sharing 749
- Memory, server
  - adding to SFT III servers 775
  - allocation, controlling 440
  - cache buffer alerts 460
  - freeing up RAM 439
  - increasing available 440
  - resolving problems 714
  - setting new end address for unclaimed 777
  - SFT III, aligning 776
  - troubleshooting 724
  - unclaimed, displaying 777
- Memory, workstation
  - increasing available amount 705
  - not swapping, with login scripts 220
- Menu commands. *See also* NMENU utility
  - EXEC (specifying actions) 814
  - GETx (specifying user input) 817
  - ITEM (specifying menu options) 810
  - LOAD (executing one menu from another) 815
  - MENU (naming menus) 809
  - SHOW (displaying submenu) 816
- Menu program. *See* NMENU utility
- MENU utility, converting to NMENU 825
- MENUCNVT command, using 825
- MENUMAKE utility, compiling converted menu program 825
- Menus. *See* NMENU utility
- Merging partitions
  - explained 301
  - with PARTMGR 301
- Merging two trees
  - after running the DSMERGE utility 347
  - using the DSMERGE utility 343
- Message Routing Group object, explained 30
- Messages
  - displaying during login 232
  - sending from console using MONITOR 404
  - sending from console using SEND 402
- Messages, error. *See* Alerts; Disk errors
- Messaging Server object, explained 30
- Metering Certificate object
  - explained 695
- Metering certificates
  - explained 695
  - installing 696
- Microsoft Windows. *See* Windows
- MINUTE identifier variable, explained 235
- Mirrored server link (MSL)

- cable lengths, listed 772
- failure message, example 796
- failure, troubleshooting 772
- troubleshooting 772
- Mirroring disks 514. *See also* Unmirroring hard disks
- Missing RAM error, troubleshooting 776
- MNU filename extension, explained 825. *See also* NMENU utility
- Modem
  - null modem cable, using 546, 552
  - running remote console session over 545
- Modify bit (Archive Needed attribute), using with SBACKUP 623
- MONITOR NLM
  - checking cache utilization 439
  - checking for disk errors 466
  - checking processor utilization 445
  - clearing workstation connection 432
  - determining connection number or username 402
  - Packet Receive Buffer value 436
  - prioritizing server processes 444
  - sending a message using 404
  - turning off read-after-write verification 453
  - viewing LAN driver statistics 447
  - viewing multiprocessor information 573
- Monitoring
  - backwards compatibility 290
  - network communication 254
  - network data 289
  - network hardware 278
  - replica synchronization 256
  - time synchronization 262
- Monitoring tools, identifying 251
- MONTH identifier variable, explained 235
- MONTH\_NAME identifier variable, explained 235
- Mounting volume

- with INSTALL 483
- failure due to insufficient RAM 472
- Moving objects
  - with NETADMIN 72, 76, 304
  - with NetWare Administrator 74
  - with NetWare Administrator (drag and drop) 71
- Moving partitions
  - explained 303
  - with NETADMIN 304
- MPDRIVER NLM 585
- MSAUTO.NCF file, explained 773
- MSEngine
  - already loaded message, explained 772
  - error log, explained 796
  - memory range, setting 777
  - name, troubleshooting 791
  - outputs, checking 770
  - unclaimed memory used by 777
- MSL boards
  - alternate, installing 772
  - troubleshooting 791
- MSL deadlock, troubleshooting 773
- MSL. *See* Mirrored server link (MSL)
- MSSTART.NCF file, explained 773
- MSSTATUS.DMP file, limiting size of 779
- Multiprocessing, with NetWare Symmetric MultiProcessing 567
- Mutual exclusion lock (mutex)
  - defined 572
  - information window 579

## N

- Name
  - container object, rules for 19
  - leaf object, rules for 33
  - server, changing 430
  - user's full, specifying in login scripts 235
  - user's last, specifying in login scripts 235

- user's login, specifying in login scripts 236
  - volume, assigning 470
- Name context
  - changing, in login scripts 193
- Name space
  - adding to volume 475
  - calculating memory required for 477
  - NFS, retains symbolic and hard links 661, 663
  - removing from volume 477
  - SBACKUP-supported formats 595
  - viewing directory or file 157
- Name, machine
  - long, specifying in login scripts 210, 236
  - short, specifying in login scripts 236
- NCF files for SFT III, explained 773
- NCP packet signature
  - CLIB NLMs and 526
  - client levels 523
  - effective 524
  - examples of 525
  - explained 521
  - job servers and 526
  - options for 521
  - server levels 522
  - turning off for RSPX 540
  - when to use 522
- NCUPDATE utility
  - updating NET.CFG files after moving
    - Container object 69
  - updating NET.CFG files after renaming
    - Container object 83
- NDAY\_OF\_WEEK identifier variable,
  - explained 235
- NDIR utility
  - checking available disk space with 489
  - viewing information about directories and files with 160
- NDS Manager utility
  - controlling access to 299
  - explained 295
  - running as a standalone executable 297
  - running from NetWare Administrator 297
  - setting up 297
- NDS synchronization status
  - viewing and managing 348
- NDS Trace, explained 348
- NDS. *See* NetWare Directory Services
- NET.CFG file, setting OS/2 nonded server option 765
- NETADMIN, setting up 5
- NetWare Administrator
  - setting up on a Windows 3.1 workstation 5
  - setting up on a Windows 95 workstation 7
  - setting up on an OS/2 workstation 8
- NetWare Administrator utility. *See also* specific task
  - file compression, setting 494
- NetWare Administrator, adding HCSS to 365, 367
- NetWare Application Launcher
  - configuring 129
  - setting up 125
  - setting up on a Windows 3.1x workstation 126
  - setting up on a Windows 95 workstation 127
- NetWare Application Manager
  - setting up 123
  - setting up on a Windows 3.1x workstation 124
  - setting up on a Windows 95 workstation 124
- NetWare Directory Services
  - managing Directory database 295
  - NetWare Licensing Services integration 688
  - NetWare Licensing Services security 691
  - partitions, explained 296
  - removing using INSTALL (caution) 281

- repairing with DSREPAIR 324
- trees, merging with DSMERGE 335
- NetWare Directory Services Manager. *See*
  - NDS Manager utility
- NetWare Directory Services, restoring
  - with partitions 630
- NetWare files
  - extracting from installation CD-ROM 414
  - location of 97
  - upgrading from remote console 553
- NetWare Licensing Services
  - clients 686
  - components 684
  - configuration 689
  - explained 684
  - installing 692
  - license certificates, installing 695
  - License Service Providers (LSPs) 685
  - licenses, managing 697
  - LSP Server object 686
  - metering certificates, installing 696
  - NDS integration 688
  - NDS security 691
  - NLS Manager utility 693
  - purpose 683
- NetWare Loadable Modules
  - language, specifying 425
  - loading 406
- NetWare Requester for DOS, version,
  - specifying in login scripts 236
- NetWare Requester for OS/2
  - SYS\:\PUBLIC directory, mapping drive to
    - in login scripts 214
  - version, specifying in login scripts 236
- NetWare server
  - abends, resolving 707
  - accounting, setting up 558
  - bindery-based, attaching to from login script 189
  - bringing down 278

- changing server language 423
- copying language files to 421
- error logs, viewing 463
- hardware, checking for new 362
- insufficient disk space, resolving 713
- managing connections to 431
- monitoring and optimizing 439
- name and IPX network number, changing
  - 430
- password for remote console 540
- processes, prioritizing 443
- processor utilization, checking 445
- remote 538
- resolving I/O errors 712
- resolving memory problems 714
- specifying in login scripts 236
- troubleshooting 707, 732
- NetWare Server for OS/2
  - allocating memory 762
  - automatic memory sharing, setting 751
  - backup support for 767
  - configuring 754
  - freeing server memory 752
  - loading 744
  - loading PMMON 746
  - managing 743
  - manual memory sharing, setting 750
  - memory sharing, setting 749
  - monitoring 746
  - navigating in 745
  - NLMs, using 745
  - NWOS2.EXE, loading with 744
  - OS/2 debugger 766
  - performance tuning 748, 766
  - PMMON utility, using 748
  - printing 745
  - removing base server memory 762
  - SET parameters 766
  - using with NetWare 4 743
- NetWare Server for OS/2, NET.CFG file



- automatic memory sharing, setting 763
- base server memory, setting 761
- block allocation size, setting 764
- entering/editing options 755
- format 754
- initialization screen delay, setting 760
- maximum server memory, setting 763
- nonded server option in 765
- setting performance tuning in 760
- syntax for entering options 759
- NetWare Server object
  - deleting 323
  - explained 31
  - naming restrictions for 35
- NetWare server, configuring
  - keyboard type, changing 426
  - time and time zone, viewing and setting 427
- NetWare shell, specifying version in login scripts 236
- NetWare SMP. *See* NetWare Symmetric MultiProcessing
- NetWare Symmetric MultiProcessing
  - architecture 568
  - benefits 564
  - enabling and disabling processors 584
  - installing 565
  - kernels 568
  - mutual exclusion locks (mutexes) 572, 579
  - overview 567
  - preemption 569
  - processor information 574
  - SET parameters for 586
  - statistics for 573
  - threads 571, 581
  - uninstalling 566
- NETWARE\_REQUESTER identifier variable, explained 236
- Network
  - address, specifying in login scripts 236
  - applications, guidelines for installing 116
  - applications, installing 109
  - directory structure, sample 100
  - installing DOS on 109
  - installing operating systems on 109
  - installing Windows on 111
  - traffic, monitoring 447
- Network boards, troubleshooting 718, 721, 728, 730, 731, 734, 735, 737, 738, 739
- Network communication, monitoring and maintaining 254
- Network data, monitoring and maintaining 289
- Network hardware, monitoring and maintaining 278
- Network monitoring and maintenance tools, identifying 251
- Network number, internal, changing 416
- Network time synchronization. *See* Time synchronization
- Network time, setting and changing 264
- NETWORK\_ADDRESS identifier variable, explained 236
- NFS, name space supported by SBACKUP 595
- NLIST utility, explained 68. *See also* SEARCH utility
- NLM. *See* NetWare Loadable Modules
- NLS clients
  - explained 686
  - license certificates, accessing 690
  - types 687
- NLS Manager utility
  - explained 693
- NLS. *See* NetWare Licensing Services
- NMENU utility
  - compiling menus 804
  - complex menu example 806
  - converting MENU program to NMENU 825

- elements, explained 802
- examples 805, 806, 820
- executing menu program from login scripts 198
- explained 799
- illustrated 801
- making menus work 823
- maximum item lines 807
- maximum number of menus 807
- maximum number of windows 807
- memory requirements 799
- name length 807
- numbering 809
- old menu files, converting 825
- planning 804
- planning menus 807
- setting up user environments 823
- simple menu example 805
- starting from login script 824
- steps in creating menus 804
- submenus, numbering 809
- syntax 800

NMENU utility, commands

- control, listed 813
- GETx, using 818
- ITEM options, explained 810
- MENUCNVT, using 825
- organizational, listed 808
- types, explained 808
- wrapping 807

NO\_DEFAULT login script command, using 170, 219

Node address, specifying in login scripts 236

Non-IBM computers

- long name, specifying in login scripts 210, 236
- short name, specifying in login scripts 236

NOSWAP login script command

- using 220
- using with # command 188

- NOT MEMBER OF "group" identifier variable, explained 236
- NWADMIN.INI file 366
- NWPA NLM, using with CDROM NLM 484
- NWXTRACT utility, using 414

## O

Object rights. *See* Rights, object

Objects

- renaming 83, 84

Objects, moving

- explained 68
- with NETADMIN 72, 76
- with NetWare Administrator 69, 71, 74

Objects. *See also* specific objects

- renaming 84, 85

Objects. *See also* specific objects

- cautions when deleting 79
- deleting from Directory tree, explained 78
- Directory Map object, mapping drive in login scripts 216
- searching for 64
- trustee assignments to, managing 13
- with login scripts 171

Operating systems, installing on network 109

Optical media. *See also* Data migration

- formatting for HCSS 375
- labeling HCSS 377
- reformatting for HCSS 383
- storing files on, explained 352

Organization object

- changing property values 87, 91
- explained 18
- login script (*see* Login scripts)

Organizational Role object

- creating 56, 58
- explained 31
- managing Users with 55

Organizational Unit object

- changing property values 87, 92
- explained 18
- login script (*see* Login scripts)
- OS identifier variable, explained 236
- OS/2 Debugger, setting for NetWare Server for OS/2 766
- OS/2 HPFS files
  - adding name space for 475
  - name space supported by SBACKUP 595
  - removing name space for 477
  - viewing information about 157, 159, 160
- OS/2 workstation. *See also* NetWare Requester for OS/2; Workstation environment variables for, setting in login scripts
- resolving memory problems 742
- using COMSPEC with
- OS/2. *See* NetWare Server for OS/2
- OS\_VERSION identifier variable, explained 236
- Out of sync disk, recovering data from 537
- Overwriting
  - deleting overwritten sessions from backup log 666
  - session on backup media 666
- Owner, directory or file
  - changing 151, 152
  - viewing information about 157

## P

- P\_STATION identifier variable, explained 236
- Packet receive buffers
  - during peak usage 437
  - explained 435
  - increasing maximum 435
  - increasing minimum 436
  - New Packet Receive Buffer Wait Time 437
  - troubleshooting 731, 734

- Packet. *See also* NCP packet signature; Packet receive buffers
  - increasing size of
  - preventing forgery
  - viewing traffic
- Parameters
  - HCSS, explained 384
  - HCSS, setting 391
  - TSASMS parameters for SBACKUP, explained 625
- Parent directory, for backup or restore explained 600, 648, 651
- Partition, Directory. *See also* Replica aborting operation, explained 306 cautions when moving 303 creating, explained 299 deleting server containing 323 explained 296 listing 315 merging, explained 301 moving, explained 303 planning 296
- Partition, disk
  - creating 511
  - deleting 513
  - mirroring 515
  - orphaned, recovering 783
- PARTMGR utility. *See* specific task
- Password
  - displaying expiration time during login 236
  - using with SBACKUP 625
- Password for remote console
  - encrypting 551
  - entering 540
- Password Restrictions property, changing 88, 93
- PASSWORD\_EXPIRES identifier variable, explained 236
- PAUSE login script command, using 221

- PAUSE option for ITEM menu command, explained 811
- PCCOMPATIBLE login script command
  - using 221
  - using with EXIT 198
- Performance tuning
  - setting for NetWare Server for OS/2 748, 766
  - setting in NET.CFG 760
- Phaser sound (FIRE PHASERS login script command) 200
- Planned backup, procedures 283
- Planning
  - directory and file system 97
  - file system, illustrated 100
  - login scripts 171
  - menus 804
  - partitions and replicas 296
- PLATFORM identifier variable, explained 236
- PMMON utility
  - loading 746
  - using 748
  - using to monitor NetWare for OS/2 746
- Postal Address property, changing 89, 94
- Power outage. *See* UPS monitoring
- Power supply errors, troubleshooting 706
- Preemption, with NetWare Symmetric MultiProcessing 569
- Preparing
  - checking time synchronization before merge 338
  - merging trees 337
- Primary server, SFT III
  - determining 796
  - failure, explained 794
  - hard disk failure, handling 780
  - IPX route to secondary, troubleshooting 793
  - network board failure, handling 787
  - troubleshooting two 772, 788
  - unloading LAN driver from 794
- Print Queue object, explained 31
- Print Server object, explained 31
- Printer object, explained 32
- Problems, system. *See* Disaster prevention and recovery; Troubleshooting
- Processes, server
  - prioritizing 443
  - viewing 446
- Processor utilization, server
  - checking 445, 574
  - prioritizing processes 443
  - redistributing 446
- Processors, enabling and disabling 585
- Profile login script. *See also* Login scripts
  - creating 179, 183
  - example 245
  - explained 170
- Profile object
  - assigning user to 178, 181
  - changing Login Script property 90, 94
  - creating 52, 54
  - explained 32
  - login script, example of 245 (*see also* Login scripts)
  - managing User objects with 51
- Prompt, setting in login scripts 226
- Properties, object . *See* Account Restrictions property; Intruder Detection/Lockout property; Login Script property; Password Restrictions property; Postal Address property; Security Equivalences property
- Property rights. *See* Rights, property
- Protecting data. *See* Security
- Protocol, binding communication 407
- Protocols
  - troubleshooting 731
- PUBLIC directory

- explained 98
- mapping drive for OS/2, in login scripts 214
- mapping drive in login scripts 215

Purging deleted files. *See also* Salvaging deleted files

- automatically, with SERVMAN 499
- with FILER 167
- with NetWare Administrator 166

## Q

Queue object. *See* Print Queue object

## R

RAM, server. *See* Memory, server

RAM, workstation

- required for NMENU 799
- required for SBACKUP 625

RCONSOLE utility

- connection types 539
- navigating with <Alt> and function keys 543
- time out error, handling 550
- using with asynchronous (modem) connection 545
- using with direct connection 539

Read property right, explained 12. *See also* Rights, property

Read/write replica. *See also* Replica changing to another type 317

Read-after-write verification, turning off 453

Read-only replica. *See also* Replica changing to another type 317 explained 297

Reads (disk), improving. *See* Disk reads, improving

Rebooting

remote servers 556

Record locks, limiting 457

Recovering deleted files with FILER 164

Redirected blocks, recording 467

Registry, system 124, 298, 367

REM (REMARK) login script command, using 223

Remote console

- callback list, creating 547
- ending session 544
- function keys 543
- loading modules on bootup 551
- modem configuration for 549
- modules required for asynchronous (modem) connection 545, 548
- modules required for direct connection 539
- password encryption 551
- password, entering 540
- starting session 539, 545
- upgrading NetWare files from 553

REMOTE NLM, using for remote console 540

Remote server

- installing or reconfiguring applications on 554
- managing from remote console 538
- rebooting 556
- upgrading files on 553

Removing

- NetWare Directory Services 279
- NetWare Directory Services using INSTALL 281
- replicas 283

Rename object right, explained 11. *See also* Rights, object

Renaming objects

- explained 83
- with NETADMIN 85
- with NetWare Administrator 84

Renaming trees

- explained 345
- using the DSMERGE utility 345
- Repairing Directory database with DSREPAIR 325
- Replica
  - changing type 317
  - creating, explained 308
  - defaults created at installation 297
  - deleting server containing 322
  - deleting, explained 310
  - explained 296
  - listing 316
  - maintaining a mixed NetWare 4 environment 292
  - planning 297
  - removing 283
  - using to manage NDS 296
- Replica synchronization
  - monitoring and maintaining 256
  - performing an immediate synchronization 260
  - status, determining 257
  - status, maintaining when a server is down 261
- Replica updates
  - receiving 313
  - sending 311
- REQUESTER\_CONTEXT identifier variable, explained 236
- Restore session, errors appended to error file 663
- Restore using SMS, explained 628
- Restore, defined 628
- Restoring
  - deleted directories and files 162, 164
  - differential backups, example 603
  - Directory database with DSREPAIR 324
  - incremental backups, example 603
  - options, explained 633
  - procedures 635

- special conditions 656
- to new location 635, 650, 653
- Resynchronizing servers, reducing time for 771
- Rights, file system
  - assigning to operating system directories 117
  - assigning to trustee 133
  - default 2
  - effective, viewing trustee 154, 155
  - explained 133
  - modifying trustee 142, 143
  - viewing and modifying Inherited Rights Filter 145, 146
- Rights, object
  - default for User 3
  - default for User ADMIN 3
  - explained 11
  - listed 11
  - trustee, changing 15
- Rights, property
  - explained 12
  - listed 12
- Root, fake
  - mapping in login scripts 212
  - mapping in login scripts, examples 217
- RS232, loading 546
- RSPX NLM, loading 539, 540
- RX-Net, troubleshooting 728

## S

- Salvaging deleted directories and files
  - with FILER 164
  - location 97
  - with NetWare Administrator 162
- SAP. *See* Service Advertising Protocol (SAP)
- SBACKUP utility, procedures
  - changing targets 675
  - checking device status 671

- checking media status 671
- deleting log files 666
- enhancing host server performance 677
- erasing or retensioning media 673
- loading drivers 610
- renaming storage device 674
- setting log and error file location 665
- troubleshooting 680
- unloading SBACKUP files 657
- viewing error file 662
- viewing log file 661
- viewing media lists 670
- SBACKUP utility. *See also* Backup
  - children and parent directories, illustrated 601
  - compressed files, handled by 676
  - error files, explained 660
  - include and exclude restore options, explained 597
  - log files, explained 659, 660
  - restore, explained 633
  - scanning, explained 600
- SBACKUP, rules for using 594
- Scanning data to back up 621, 622
- SCHDELAY utility, using 443
- Scripts. *See* Login scripts
- SCSI disk. *See* Hard disk
- Search drive
  - deleting, in login scripts 212
  - mapping in login scripts 210
  - mapping to fake root, in login scripts 212
  - mapping to physical volume, in login scripts 212
  - recommended order, in login scripts 215
- Search path, adding server 410
- SEARCH utility
  - creating searchable container objects 21
  - creating searchable leaf objects 35
  - searching with 64, 66, 68
  - using 411
- SECOND identifier variable, explained 235
- Secondary server, SFT III
  - missing RAM error explained 776
  - restarts, troubleshooting 770
- SECURE CONSOLE utility, using 519
- Security
  - intruder prevention (*see* NCP packet signature)
  - mirroring and duplexing hard disks 514
  - preventing packet forgery 521
  - preventing virus infection 520
  - remote console 538
  - risks associated with job servers 526
  - securing server console 519
  - Transaction Tracking System 535
  - uninterruptible power supply 528
- Security Equivalences property, setting for User 89, 94
- Segment, adding volume 481
- Semicolon, using in login scripts 223
- SEND command 402
- Server console. *See also* NetWare server; Remote console
  - editing text files from
  - securing
- Server DOS clock, maintaining accuracy 264
- Server hardware, troubleshooting 730
- Server memory. *See* Memory, server
- Server object
  - caution when deleting 79
  - explained 2
- Server products, installing, uninstalling, and configuring 412
- Server synchronization, maintaining 261
- Server utilities. *See* specific utility name
- Server. *See* NetWare server
- SERVER.EXE file, troubleshooting 717
- Service Advertising Protocol (SAP)
  - Directory tree mode for 267

- method of time synchronization, explained 269
- SERVMAN NLM
  - purging deleted files 499
- SET login script command, using 224
- SET parameters, in NetWare server for OS/2 766
- SET TIME utility, using 428
- SET TIMESYNC parameters, listed 266
- SET utility
  - controlling file compression with 497
  - displaying alert messages with 460
  - minimum cache buffers 679
- SET\_TIME login script command, using 227
- SFT III log files
  - explained 796
  - limiting size of 779
- SFT III server
  - clients, finding 785
  - configuration files, explained 773
  - console messages, logging 778
  - failure, troubleshooting 794
  - loading SBACKUP 627
  - memory, troubleshooting 775
  - testing 797
- Shell, NetWare, specifying version in login scripts 236
- SHELL\_TYPE identifier variable, explained 236
- SHIFT login script command, using 228
- Short machine name, specifying in login scripts 236. *See also* Machine name
- SHORT\_YEAR identifier variable, explained 235
- SHOW menu command, explained 816
- SHOW option for ITEM menu command, explained 811
- Signature level. *See* NCP packet signature
- SMACHINE identifier variable, explained 236. *See also* Machine name
- SMP. *See* NetWare Symmetric MultiProcessing
- SMS, explained 591
- Software, obtaining updates and patches 250
- SRC file extension for menus 804
- Stack size, changing 625
- Standby MSL. *See* Alternate MSL boards, installing
- Standby power. *See* UPS monitoring
- STARTUP.NCF file, creating or editing 416
- STATION identifier variable, explained 236
- Storage Management System (SMS)
  - defined 592
- Storage, file. *See* Data migration; Optical media
- Subdirectory. *See* Directory
- Submenus, defining and numbering 809
- Subscript, executing as part of login script 207
- Subsets of data to restore, specifying 621, 622
- Subsystem. *See* Hard disk
- Supervisor object right, explained 11. *See also* Rights, object
- Supervisor property right, explained 12. *See also* Rights, property
- SWAP login script command
  - compared to NOSWAP 220
  - using 230
  - using with # command 188
- Symmetric multiprocessing. *See* NetWare Symmetric MultiProcessing
- Synchronization of network time. *See* Time synchronization
- SYS: volume
  - directories in, created automatically 97
  - required for NetWare 469
  - troubleshooting SFT III problems 797
- SYS:DELETED.SAV directory, explained 97
- SYS:DOC directory, explained 98
- SYS:ETC directory, explained 97
- SYS:LOGIN directory, explained 97



- SYS:MAIL directory, explained 97
- SYS:PUBLIC directory
  - explained 98
  - mapping drive in login scripts for OS/2 214
  - mapping search drive in login scripts 215
- SYS:SYSTEM directory, explained 98
- SYS:SYSTEM/TSA/LOG directory, explained 659
- SYS\ : volume
  - troubleshooting SFT III problems 789
- SYS\_LOG.ERR file, viewing 463
- SYSICON utility. *See* NetWare Administrator; NETADMIN; specific task
- SYSTEM directory, explained 98
- System files, extracting from installation CD-ROM 414
- System login script. *See also* Login scripts
  - creating 179, 183
  - example 242
- System messages. *See* Alerts
- System registry 124, 298, 367

## T

- Target Service Agent (TSA)
  - defined 593
  - DOS workstation, command 624
  - DOS workstation, parameters 625
  - OS/2 workstation, command 624
- Target, backup or restore
  - changing targets 675
  - not listed in SBACKUP 614, 637
- TEMP SET login script command. *See* SET login script command
- Template. *See* User template
- Test Mode, SFT III
  - recovery options, listed 795
  - troubleshooting 797
- Testing
  - for bad blocks 468
  - software and hardware 250
- Text file
  - displaying during login 194
  - editing from server console 418
  - executing as subscript of login script 207
- Text, displaying during login 232
- Threads, in NetWare Symmetric MultiProcessing
  - defined 567
  - information window 581
  - migration 571
- Time
  - setting 264
  - specifying for delayed backup 618
  - specifying in login scripts 235
  - workstation, synchronizing with server in login scripts 227
- Time and time zone
  - changing server time zone 428
  - setting server time 428
  - viewing server time 427
- Time out error, RCONSOLE, handling 550
- Time server type. *See* Time synchronization
- Time synchronization
  - adjusting time servers 272
  - configuration file, editing 268
  - creating custom configuration 270
  - custom configuration method, explained 269
  - example with two Directory trees 276
  - managing network 266
  - monitoring and maintaining 262
  - parameters listed 266
  - problems, avoiding 275
  - recognizing Directory tree structure 273
  - SAP method, explained 269
  - time server type 268
- TIME utility, using 427
- TIMESYNC NLM, automatically loaded 266

- TIMESYNC.CFG file, editing 268
- Token ring, troubleshooting 740
- Traffic, viewing server 446
- Transaction Tracking System (TTS)
  - backing out of transactions automatically 535
  - enabling 535
  - logging backed-out data 536
- Tree. *See* Directory tree
- Troubleshooting
  - abends 707
  - active hubs 738
  - ARCnet problems 736
  - backup and restore sessions 680
  - cabling 728, 731, 734, 736, 737
  - cache buffers 734
  - client connections disrupted 735
  - communication problems 728
  - controller board 704
  - directory buffers 734
  - Directory Entry Table, corrupted 725
  - disk errors 723
  - Ethernet 738
  - File Allocation Table, corrupted 725
  - hardware and network 703
  - interference, cabling 734
  - LAN Support (IBM) 740
  - MAU 741
  - memory 714
  - NetWare server 707
  - network address, conflicting 703
  - network boards 718, 721, 728, 730, 731, 734, 735, 737, 738, 739
  - node number, duplicate 736
  - packet receive buffers 731, 734
  - protocol not bound 731
  - server hardware 730
  - server memory 724
  - server speed 734
  - SERVER.EXE file, corrupted 717
  - T-connectors 739
  - token ring 740, 741
  - traffic, high network 734
  - volumes, mounting 721
  - workstations 741
- Troubleshooting SFT III
  - I'm alive packets 792
  - IOEngine number 790
  - IPX internal network number 790
  - IPX route to secondary server 793
  - loader errors 779
  - lost interrupt alerts 778
  - missing RAM 776
  - MSEngine name 791
  - MSL boards 791
  - MSL problems 772
  - secondary server restarts 770
  - server failure 794
  - server memory 775
  - server Test Mode 797
  - SYS: volume problems 797
  - two primary servers 772, 788
  - unknown commands 797
  - volume SYS\\*: problems 789
  - workstation problems 786
- Trust option, using with SBACKUP 625
- Trustee rights. *See also* Rights; Trustee
  - effective, viewing
  - explained
- Trustee. *See also* Rights; Trustee rights
  - adding to directory or file
  - assignment, explained
  - deleting from directory or file
  - explained
  - list, explained
  - managing assignments to objects
  - modifying rights
  - object, managing assignments
- TTS. *See* Transaction; Tracking System (TTS)

# U

- Unclaimed memory
  - displaying 777
  - setting new end address for 777
  - used by MSEngine 777
- Uninstalling server products 412
- UNIX files
  - adding name space for 475
  - backing up linked 594
  - removing name space for 477
  - viewing information about 158, 159, 160
- Unknown command error, troubleshooting
  - SFT III 797
- Unloading
  - optical media 379
  - SBACKUP files 657
- Unmirroring hard disks 517
- Updates, obtaining new software and utilities 250
- Updating replicas
  - receiving 313
  - sending 311
- Upgrading
  - files on remote server 553
  - login scripts 173
- UPS monitoring
  - using non-serial port 528
  - using serial port 529
- User ADMIN. *See* ADMIN User object
- User login script. *See also* Login scripts
  - creating 177, 179
  - example 246
  - explained 170
  - NO\_DEFAULT command, using 170
- User object
  - cautions when deleting 79
  - changing property values 88, 93
  - default rights, listed 3
  - explained 32

- User object ADMIN. *See* ADMIN User object
- User object in login scripts
  - full name, specifying 235
  - ID number, specifying 236
  - last name, specifying 235
  - login name, specifying 236
- User Space Limits property, changing in volume 91
- User template
  - creating 62
  - explained 60
- USER\_ID identifier variable, explained 236
- Utilities in login scripts
  - DOS, mapping drive to 215
  - executing 187
  - OS/2, mapping drive to 214
- Utilities, for maintaining Directory tree 249
- Utilization
  - cache, viewing 439
  - processor, checking 445

# V

- Variables
  - <variable> identifier variable, explained 237
  - environment (DOS and OS/2), setting in login scripts 224
  - GETP command, example 819
  - login script, explained 187
- VERIFY. *See* DOS VERIFY login script command
- Virus infection, preventing 520
- Volume
  - adding name space support to 475
  - changing size of 482
  - creating 469
  - creating for HCSS 362
  - deleting 472
  - dismounting 471

- full alerts, setting 462
- mapping drive in login scripts 212
- mounting 471
- removing name space support from 477
- renaming 473
- repairing 477
- segment, adding 481
- using CD-ROM as 483

Volume object

- created automatically 468
- explained 33
- INSTALL cannot delete 473
- INSTALL cannot rename 474

Volume Restrictions property, changing 91, 95

Volume SYS

- troubleshooting SFT III problems 789

Volume SYS:

- troubleshooting SFT III problems 797

Volume SYS:maintaining sufficient disk space 289

VREPAIR NLM

- removing name space support 477
- repairing volumes 477

## W

WAN link, bringing down 278

Warnings. *See* Alerts

Watchdog parameters, changing 433

Windows

- files required to run with NetWare 112
- installing on network 111
- mapping search drive in login scripts 215
- network installation methods, explained 111
- running on network 113

Windows 3.x workstation, preparing for HCSS 365

Windows 95 and Windows NT files

- adding name space for 475
- removing name space for 477

Windows 95 workstation, preparing for HCSS 367

Workstation connections, troubleshooting 735

Workstation problems, troubleshooting SFT III 786

Workstation, preparing for HCSS 365, 367

Workstation, specifying in login scripts

- clearing screen 191
- connection number 236
- machine name 210
- network address 236
- node address 236
- PCCOMPATIBLE command 198
- platform 236
- time, synchronizing with server 227

Workstation. *See also* DOS workstation; OS/2 workstation; Windows workstation

- increasing available memory
- sending messages to troubleshooting

Workstation. *See also* DOS workstation; OS/2 workstation; Windows workstation

- clearing connection
- network address, specifying in login scripts
- operating system directories, explained

WRITE login script command, using 232

Write property right, explained 12. *See also* Rights, property

## Y

YEAR identifier variable, explained 235

# User Comments

We want to hear your comments and suggestions about this manual. Please send them to the following address:

Novell, Inc.  
Documentation Development  
MS C-23-1  
122 East 1700 South  
Provo, UT 84606  
U.S.A  
Fax: (801) 861-3002

IntranetWare  
*Supervising the Network*  
Part #100-000xxx-001 A  
September 1997

For technical support issues, contact your local dealer.

Your name and title: \_\_\_\_\_

Company: \_\_\_\_\_

Address: \_\_\_\_\_

\_\_\_\_\_

\_\_\_\_\_

Phone number: \_\_\_\_\_ Fax: \_\_\_\_\_

I use this manual as  an overview  a tutorial  a reference  a guide  \_\_\_\_\_

	Excellent	Good	Fair	Poor
Completeness	<input type="checkbox"/>	<input type="checkbox"/>	<input type="checkbox"/>	<input type="checkbox"/>
Readability (style)	<input type="checkbox"/>	<input type="checkbox"/>	<input type="checkbox"/>	<input type="checkbox"/>
Organization/Format	<input type="checkbox"/>	<input type="checkbox"/>	<input type="checkbox"/>	<input type="checkbox"/>
Accuracy	<input type="checkbox"/>	<input type="checkbox"/>	<input type="checkbox"/>	<input type="checkbox"/>
Examples	<input type="checkbox"/>	<input type="checkbox"/>	<input type="checkbox"/>	<input type="checkbox"/>
Illustrations	<input type="checkbox"/>	<input type="checkbox"/>	<input type="checkbox"/>	<input type="checkbox"/>
Usefulness	<input type="checkbox"/>	<input type="checkbox"/>	<input type="checkbox"/>	<input type="checkbox"/>

Please explain any of your ratings: \_\_\_\_\_

\_\_\_\_\_

\_\_\_\_\_

\_\_\_\_\_

\_\_\_\_\_

In what ways can this manual be improved? \_\_\_\_\_

\_\_\_\_\_

\_\_\_\_\_

\_\_\_\_\_

You may photocopy this comment page as needed so that others can also send in comments.