

Contents

How to Use This Manual

Contents Overview	vii
Installation Options	viii
Installation Process Diagram	ix
User Comments	x

1 Prepare to Install

Set Up Hardware	11
Prerequisite Tasks.	11
Hardware Requirements	12
Novell's Yes Program	13
Calculate Necessary Server RAM.	14
Choose an Installation Method	15
Prepare to Install on a Windows 95 Machine	16
Install from a Local CD-ROM	17
Install from a Remote Network Installation Area	18
Install from a CD-ROM Mounted as a NetWare Volume on a Network Server	19
Install from a NetWare Volume Containing NetWare 4.11 CD-ROM Files . .	21
Where to Go Next	23

2 Simple Installation

Suggested Resources.	26
Install Server Software	26
Choose the Type of Installation	28
Name Your Server and Copy Boot Files	29
Install NetWare SMP (Conditional)	30
Load the Device Drivers.	31
Load the LAN Drivers	34
Mount the CD-ROM as a NetWare Volume (Conditional).	38
Create the NetWare Disk Partition	39
Establish the Server-to-Server Session (Conditional).	40
Install Novell Directory Services	42
Install the First NetWare 4 Server	43

The Server Cannot Locate a Previously Installed Directory Tree	45
Install into the Single Existing Directory Tree	46
Install into an Existing Directory Tree	48
Install the License Server	50
Copy Remaining NetWare Files	50
Review the Created Directory Tree (Optional)	52
Review the Created Trustee Assignments (Optional)	52
Other Installation Options (Optional)	53
Create a Registration Diskette	54
Make Diskettes	55
Exit Install	57
Where to Go from Here	57

3 Custom Installation

Suggested Resources	60
Choose a Server Boot Method	60
Install the Server Software	60
Choose the Type of Installation	62
Name Your Server and Assign an IPX Network Number	64
Copy Server Boot Files to the DOS Partition	65
Specify Language and Filename Format Information	66
Install NetWare SMP (Conditional)	68
Load the Device Drivers	70
Load the LAN Drivers	73
Mount the CD-ROM as a NetWare Volume (Conditional)	79
Create NetWare Disk Partitions	79
Manage NetWare Volumes	86
Save and Mount Volumes	98
Install NetWare/IP (Conditional)	98
Establish Server-to-Server Session (Conditional)	103
Copy NetWare Files	103
Installing Novell Directory Services	105
Install the First NetWare 4 Server	107
The Server Cannot Locate a Previously Installed Directory Tree	108
Install into the Single Existing Directory Tree	109
Install into an Existing Directory Tree	111
Set Up Time Synchronization	112
Specify the Server's (Name) Context	117
Review the Created Directory Tree (Optional)	121
Review the Trustee Assignments Created (Optional)	122
Restore Server from Backup (Optional)	123
Install the License Server	124
Modify the STARTUP.NCF File	124

Modify the AUTOEXEC.NCF File	127
Perform Other Installation Options (Optional).	131
Create a Registration Diskette	132
Upgrade 3.1x Print Services.	133
Install NetWare for Macintosh	133
Install NetWare Client for Mac OS	134
Install NetWare IP	134
Install NetWare DHCP.	134
Configure Network Protocols	134
Configure NetWare Licensing Service (NLS)	135
Install an Additional Server Language.	136
Change Server Language	136
Set Up a Network Directory for Client Install	137
Make Diskettes	138
Exit the Install Utility.	139
Where to Go from Here	140

4 Install NetWare Server for OS/2

Overview	143
Necessary Resources	143
Hardware Requirements	143
Software Requirements	144
Install Server Software	144
Choose an Installation Medium	145
Install from CD-ROM	146
Install from a Remote Network Installation Area	147
Requirements for a Network Installation Area.	147
Recommendations for a Network Installation Area	147
Remote Installation Areas	148
Install from a CD-ROM Mounted as a NetWare Volume	148
Install from a NetWare Volume with Files Copied on a Server	151
Determine Which Installation Option to Use	152
Install Using Simplified NetWare Server for OS/2 Option	153
Assumptions Made by the Simplified Option	153
Install Using the NetWare Server for OS/2 Option	156
Sharing a Network Board	158
Enter Installation Information	164
Choose the Server Drivers	167
Load a LAN Driver.	167
Install NetWare Client for OS/2	173
Upgrade NetWare Server for OS/2	181
Upgrade from CD-ROM	181
Upgrade from a Remote Server Installation Area	183

Changing Network Board Sharing Configurations	185
Changing from TOKENSHR to TOKENLNK	185
Changing from TOKENLNK to TOKENSHR	190
Changing from LANSHARE to TOKENSHR or TOKENLNK	192
Changing from TOKENSHR or TOKENLNK to LANSHARE	194

5 Install NetWare 4.11 SFT III

Necessary Resources	197
Prerequisite Tasks	200
Install SFT III Servers	201
Name and Number the Server Engines	201
Copy NetWare 4.11 SFT III Files	203
Choose Mirrored Server Link (MSL) Drivers	204
Install SFT III on Server 2	204
Create and Mirror the NetWare Disk Partitions	206
Edit Server Configuration Files (Optional)	208
View SFT III Console Displays	212
Implement Dual Processing (Optional)	212
Upgrade from SFT III 3.11 and 4.1	213
Edit SFT III 3.11 .NCF Files (Optional)	214
Upgrade Server 1	216
Upgrade Server 2	217

A Calculate RAM Requirements

Overview	219
Memory Calculation	219
Memory in NetWare 3 and 4	220
The Worksheet	220
Additional Memory Considerations	221

B Name Space Requirements

Overview	223
The Directory Cache Connection	223
DET Ratios	224
Cache Memory Requirements	224
Sizing Server Memory	225
Three Tuning Strategies	225
Strategy 1: Handling Low Usage	226
Strategy 2: Handling Very High Usage	226
Strategy 3: Tuning the Cache	226

C Country Codes

D	Install To Boot From Floppy Diskette	
E	Creating Client Diskettes	
	Prerequisites233
	Create Client Diskettes234
	Create Client Diskettes at the Server234
	Create Client Diskettes from a Workstation235
	Create Macintosh Client Diskettes237
F	Install Using RCONSOLE	
	Hardware Configuration Requirements240
	Prerequisite Tasks240
	Necessary Resources241
	Copy Files For the New Server241
	Install Files and Configure the New Server243
	Configure the DOS Client and Install the Server245
G	Understanding Driver Architecture	
	Monolithic Architecture250
	NetWare Peripheral Architecture (NWP)250
H	Red Box CD-ROM Drivers	
	Trademarks	
	Novell Trademarks259
	Third-Party Trademarks260
	Index	

How to Use This Manual



In Novell® documentation, an asterisk denotes a trademarked name belonging to a third-party company. Novell trademarks are denoted with specific trademark symbols, such as ™.

Contents Overview

There are many steps to getting your NetWare® 4.11 server installed and operating with client workstations on a network. A diagram outlining the process is shown under the heading “Installation Process Diagram” on page ix.

Begin by reading Chapter 1, “Prepare to Install” to plan your network and prepare your equipment for installation. If necessary, read *Guide to NetWare 4 Networks* to plan your Novell Directory tree.

Next, install a new NetWare 4.11 server by following the installation procedures in Chapter 2, “Simple Installation” on page 15, or Chapter 3, “Custom Installation” on page 49, or, for an OS/2 network, see Chapter 4, “Install NetWare Server for OS/2” on page 133.

You can also perform other installation options such as installing NetWare 4.11 clients or creating NetWare 4.11 client diskettes. Procedures for performing other installation options are included at the beginning of Chapter 3 and at the end of Chapter 2 and Chapter 3.

Next, install the NetWare client software on each workstation in your network by following the procedures in Chapter 6, “Install NetWare Clients” on page 211.

Next, set up the documentation viewers to view the NetWare 4.11 online documentation. Procedures for doing so are included in *Installing and Using Novell Online Documentation*.

Finally, administer the NetWare 4.11 network by reading *Supervising the Network*, which is available online.



To set up or maintain a network in the NetWare Enhanced Security configuration (the Class C2 evaluated configuration), you must supplement the information in this manual with the information in *NetWare Enhanced Security Server*, *NetWare Enhanced Security Administration*, *Security Features User Guide*, and *Auditing the Network*. All of these manuals are part of the online documentation collection that came with your software.

Installation Options

You can install a NetWare 4.11 server using either the simple installation or custom installation option.

The simple installation is both quicker and easier to perform than the custom installation.

The custom installation option makes no assumptions and lets you customize your server installation. Additional options, such as spanning volumes across multiple drives and loading and binding TCP/IP and AppleTalk, are available only in the custom installation option.

Procedures for installing using the simple installation are found in Chapter 2, “Simple Installation” on page 15.

Procedures for installing using the custom installation are found in Chapter 3, “Custom Installation” on page 49.

Installation Process Diagram



Plan Directory Tree

Read *Guide to NetWare 4 Networks* and plan your Directory tree.



Install New Server

Install a new NetWare 4.11 server. *(Optional)* Install NetWare 4.11 SFT III™ for mirrored servers.



Perform Other Installation Options

From the “Other Installation Items/Products” menu, create client diskettes and perform other installation options as you choose.



Install NetWare Clients

Install the NetWare client software on each computer.



Set Up Documentation Viewer

Set up or install the NetWare 4.11 online documentation by reading *Installing and Using Novell Online Documentation*.



Administer Network

Administer the network using the NetWare administration utilities.

User Comments

We are continually looking for ways to make our products and our documentation as easy to use as possible.

You can help us by sharing your comments and suggestions about how our documentation could be made more useful to you and about inaccuracies or information gaps it might contain.

Submit your comments by using the User Comments form provided or by writing to us directly at the following address:

Novell, Inc.
Documentation Development MS C-231
122 East 1700 South
Provo, UT 84606 USA

e-mail: commentdoc@novell.com

We appreciate your comments.

This chapter provides information and procedures necessary for preparing to install a NetWare® 4.11 server. The information in this chapter will help you to

Checklist



- Meet the hardware requirements
- Ensure proper power and power conditions
- Set up computer and networking hardware
- Choose an installation method

If you are installing an OS/2 server, go directly to Chapter 4, “Install NetWare Server for OS/2,” on page 143.

Set Up Hardware

Prerequisite Tasks

Checklist



- Plan your Directory tree. See *Guide to NetWare 4 Networks* for guidelines and suggestions.
- Run the computer's Setup program and set the computer's time to the exact local time. (The time synchronization feature in Novell Directory Services uses the computer's time setting.)
- If you install from another server, make sure the new server is cabled to the network and has the NetWare client software installed.

- If necessary, partition and format your hard disk. You can boot from the NetWare *License* diskette or from a DOS partition. If you intend to boot from a DOS partition, create a DOS partition of at least 15 MB on your hard disk. Type FDISK and follow the screen prompts to repartition the hard disk. Reboot the machine and type FORMAT to format the partition.



In some cases, it is easier to troubleshoot server problems by increasing the DOS partition 1 MB for every 1 MB of server RAM. For example, if your server had 18 MB of RAM, you might want to increase the DOS partition from 15 MB to 33 MB (15 MB + 18 MB = 33 MB).

A 15MB DOS partition should be sufficient for storing the files needed to boot your server. If you need to store additional files on the DOS partition, make the partition larger.



Reformatting your hard disk erases all stored files on the DOS partition. Be sure to back up your hard disk prior to partitioning and formatting.

Installation is much easier when you install with the intention of booting the server from a DOS partition on the server's hard disk. However, if you want to boot the server from floppy diskettes, you do not need a DOS partition.

For procedures on installing the server to boot from floppy diskette, see "Install To Boot From Floppy Diskette" on page 231.

- Check the list of hardware requirements below.
- To ensure that there are no conflicts between hardware devices, use unique interrupt request (IRQ) settings on the NetWare server board.

Hardware Requirements

You need the following hardware for installing a NetWare 4.11 server.



- A PC (or PC compatible) with a 386, 486 (SX or DX), Pentium, or higher processor
- A minimum of 20 MB of RAM



If you are installing over the network using Novell Client 32, you need to set MAX CACHE SIZE less than or equal to 3 MB. If you do not, Client 32 could allocate up to 8 MB on a machine with 20 MB of RAM. You could possibly run out of RAM during installation.

- At least one network board
- Network cabling (Ethernet, token ring, FDDI, ARCnet*, baseband, etc.)
- A CD-ROM drive that can read ISO 9660 formatted CD-ROM disks
- If installing from a remote network installation, an existing NetWare workstation (this will be the new server you install) and an existing NetWare server (this will be the host server)
- A hard disk with sufficient storage space for your network. The minimum amount of storage space required is 105 MB: 15 MB for a DOS partition plus 90 MB for a NetWare disk partition containing volume SYS:.

However, if you choose to install other product options as explained in Chapter 3 “Custom Installation” under the heading “Perform Other Installation Options (Optional)” on page 131, you need a minimum of 140 MB for volume SYS:. We therefore recommend a larger volume SYS:.

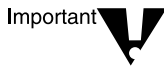

Since NDS objects are stored on volume SYS:, make sure you leave adequate space for additional NDS objects if you anticipate growth of your network.

If you plan to install the DynaText* viewer and the NetWare 4.11 documentation on the server, add another 60 MB of disk space.

If desired, you can read the NetWare 4.11 online manuals directly from the CD-ROM without having to install the files to the server.

Novell’s Yes Program

To be certain of hardware compatibility with NetWare, look for one of the following symbols:



The Yes Program, Novell's trademarking and certification program, helps Novell customers identify and purchase Novell-compatible third party hardware and software products. The Yes Program provides developers with the opportunity to test and certify their products against Novell's strict quality standards to ensure that their products are compatible with Novell products. Once products have passed the Yes Program's business and certification requirements, they are eligible to use a Yes logo.

The Yes Program includes trademarking for products that are compatible with NetWare network operating systems and other Novell products such as ManageWise, GroupWise, and NetWare Telephony Services.

Calculate Necessary Server RAM

To calculate your server's total RAM requirements, perform the following steps. (NetWare 4.11 can support up to 4 GB of RAM and up to 32 TB of disk storage space.)

These RAM calculations are only estimates. It may be necessary to adjust these figures for optimal performance. For more detailed information on calculating RAM requirements, see Appendix A, "Calculate RAM Requirements," on page 219.

Procedure

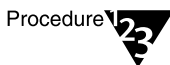

1. **Make sure that you have a *minimum* of 20 MB of RAM.**
2. **Multiply the amount of your system's disk space (in megabytes) by 0.008 and add this number to the number from Step 1.**

For example, 200 MB multiplied by 0.008 equals 1.6 MB.

3. **Add 1 to 4 MB for additional cache buffer RAM to optimize performance.**

The more RAM you provide for cache buffers, the better your system's performance will be.

If you have a server that contains more than 20 MB of RAM, do *not* use anything less than 32-bit AT busmastering or DMA boards in

the server, unless the driver supports going above 20 MB of RAM. For more information, contact the computer manufacturer.



If you have a 386 computer manufactured in 1987, it may not carry out some 32-bit instructions. This could adversely affect the functioning of NetWare.

If a problem exists, NetWare displays a message. You may be able to correct the problem by replacing a ROM chip on the board. For more information, contact your computer manufacturer.



Choose an Installation Method

You can install a NetWare 4.11 server from a local CD-ROM drive or from a CD-ROM drive mounted on a remote network installation area.

If you are installing the first in a series of NetWare 4.11 servers on a new network, you must install from CD-ROM.

Figure 1-1 lists factors to consider before choosing an installation method.

Figure 1-1
Installation Method

	 CD-ROM	 Remote network installation area
Speed of Installation	Slower than from a network.	Faster than from a CD.
Hardware Configuration Requirements	Requires a CD-ROM player installed as a DOS device on the designated server.	Requires an existing network with either a server with sufficient disk space to store the NetWare 4.11 files, or the NetWare 4.11 CD-ROM mounted as a NetWare volume.
Ease of Installation	Requires setup of CD-ROM drive and drivers.	Simple. Must install as a NetWare client first.

If you are installing from a Windows 95 machine, continue with “Prepare to Install on a Windows 95 Machine” below. Otherwise, go to “Install from a Local CD-ROM” on page 17 or to “Install from a Remote Network Installation Area” on page 18, depending on the install method you have chosen.

Prepare to Install on a Windows 95 Machine

If your machine is running Windows 95 pre-installed, or you have installed Windows 95 before planning a NetWare installation, you need to



- Reduce the size of the Windows 95 partition to allow room for the NetWare partition. Otherwise, you need another hard disk for the NetWare partition, and the hard disk allocated to the Windows 95 partition will not be accessible to your NetWare server.



There are a number of tools that allow you to reduce the size of a Windows 95 partition. An alternative to using such a tool is to back up the Windows 95 information, repartition and reformat your hard disk to make the Windows 95 partition smaller, and then re-install Windows 95.

- Boot your Windows 95 machine in MS-DOS command mode to launch the NetWare Installation program. (Although you can use the Windows 95 machine to boot to NetWare, you cannot launch the DOS-based NetWare installation program from a DOS box in Windows 95 because Windows 95 puts the CPU in protected mode.)



If you do not want to retain Windows 95 on your hard disk, you can repartition and reformat your hard disk with the DOS FDISK and FORMAT utilities that are on the NetWare License diskette. Your hard disk would then be prepared to run the DOS-based NetWare installation program.

Procedure

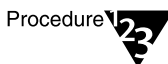

To boot your Windows 95 machine in MS-DOS command mode, perform the following steps.

- 1. With the machine running Windows 95, choose <Start> on the Windows 95 taskbar, and then choose <Shutdown>.**
- 2. Choose the <Restart Computer in MS-DOS Mode>, and then choose “Yes.”**

3. **At the DOS command line, change to the root directory, and then use the ATTRIB command to unhide the file MSDOS.SYS by typing**

CD\

and then typing

ATTRIB -R -S -H MSDOS.SYS

4. **Edit the file MSDOS.SYS to change the “BootGUI” option from “1” to “0”.**

This will cause the system to boot in MS-DOS command mode.

5. **Reset the attributes on the file MSDOS.SYS by typing**

ATTRIB +R +S +H MSDOS.SYS

6. **Reboot the computer.**

Important



After booting in MS-DOS command mode, if you are installing NetWare from a CD-ROM drive, make sure that both the drivers and the CD-ROM extensions are being loaded in the CONFIG.SYS and AUTOEXEC.BAT files respectively. When Windows 95 runs in GUI mode, it might use 32-bit drivers that do not work in MS-DOS command mode.

7. **Continue with “Install from a Local CD-ROM” on page 17 or to “Install from a Remote Network Installation Area” on page 18, depending on the install method you have chosen.**

Install from a Local CD-ROM

Procedure

Procedure



1. **If you have not done so already, install the CD-ROM drive and drivers according to the manufacturer’s instructions.**

Usually, the installation program for your CD-ROM automatically updates the CONFIG.SYS and AUTOEXEC.BAT files to add the CD-ROM device driver.

If not, follow the manufacturer’s instructions to create or update these files.

2. **Insert the *NetWare 4.11 Operating System* CD-ROM into the CD-ROM drive.**

3. **Reboot the computer.**

Rebooting executes the CONFIG.SYS and AUTOEXEC.BAT files and recognizes the CD-ROM drive as a DOS device.

4. **Change to the drive letter corresponding to the CD-ROM.**

This is generally drive D:.

5. **Continue with “Where to Go Next” on page 23.**

Install from a Remote Network Installation Area

A NetWare 4.11 server can be installed over the network in two ways: from the CD-ROM mounted as a NetWare server volume or from CD-ROM files copied to a NetWare server volume.

In either scenario, a user logs in to a server with a remote network installation area and installs the workstation as a NetWare 4 server through the Installation utility.

Requirements and recommendations for a remote installation are outlined below.

Requirements for a Network Installation Area

- ◆ The server with the CD-ROM image should not be RIP-filtered from the server being installed. To find out if your network has RIP filtering, load FILTCFG.NLM at the server and view IPX protocol filters.
- ◆ The server being installed should use an IPX internal network number that is not RIP-filtered from the server with the CD-ROM image.

Recommendations for a Network Installation Area

- ◆ For better performance, the server with the CD-ROM image should have Packet Burst support. NetWare 3.12 and NetWare 4

servers have Packet Burst support built in. NetWare 3.11 requires PBURST.NLM for Packet Burst support.

- ◆ For better performance, the server with the CD-ROM image should have LIP (Large Internet Packet) support enabled. NetWare 3.12 and NetWare 4 servers have LIP support enabled by default (SET "ALLOW LIP = ON"). NetWare 3.11 requires LIPX.NLM for LIP support.

Remote Installation Areas

The remote installation area can consist of one of the following:

- ◆ A NetWare 4.11 CD-ROM mounted as a NetWare volume
- ◆ The NetWare 4.11 CD-ROM files copied to a volume on a NetWare 4 server

If you want to	Go to
Install from a NetWare 4.11 CD-ROM mounted as a NetWare volume	"Install from a CD-ROM Mounted as a NetWare Volume on a Network Server" below
Install from a NetWare 4.11 server volume containing copied NetWare files	"Install from a NetWare Volume Containing NetWare 4.11 CD-ROM Files" on page 21

Install from a CD-ROM Mounted as a NetWare Volume on a Network Server

Necessary Resources



- An existing NetWare server. (This will be the host server.)
- An existing NetWare workstation. (This will be the server you install.)
- A CD-ROM drive that can read ISO 9660 formatted CD-ROM disks.

This CD-ROM drive is mounted as a volume on the NetWare 4.11 host server.

Procedure

1. **Cable the CD-ROM drive to the NetWare 4 server (host server).**

Since you are installing the CD-ROM as a NetWare volume, you do not need to install any drivers at this time.

2. **Insert the *NetWare 4.11 Operating System* CD-ROM into the CD-ROM drive.**

3. **At the C:\NWSERVER directory, type**

`SERVER <Enter>`

4. **At the server console, type**

`LOAD INSTALL <Enter>`

The following menu appears:

Figure 1-2

The "Installation Options" Menu

Installation Options	
Driver options	(load/unload disk and network drivers)
Disk options	(configure/mirror/test disk partitions)
Volume options	(configure/mount/dismount volumes)
License option	(install the server license)
Copy files option	(install NetWare system files)
Directory options	(install NetWare Directory Services)
NCF files options	(create/edit server startup files)
Multi CPU options	(install/uninstall SMP)
Product options	(other optional installation items)
Exit	

5. **Choose "Driver Options."**
6. **Choose "Configure Disk and Storage Device Drivers."**
7. **Choose "Select an Additional Driver."**

You are prompted to enter the path to the source directory where the NetWare 4.11 files are located.

8. **Choose the necessary CD-ROM drivers according to the documentation that accompanied your CD-ROM drive.**

If the device drivers you need are not listed, press <Ins> and follow the prompts to access a new list of drivers.



For information on the CD-ROM drivers that are shipped in the Red Box (NetWare 4.11 product package), along with their proper load order, see Appendix A, "Calculate RAM Requirements," on page 219.

9. **Once you have loaded all necessary drivers, from the "Additional Driver Actions" menu choose "Return to Previous Menu."**
10. **Press <Alt>+<F10> and choose "Yes" to exit INSTALL.NLM.**
11. **At the console prompt, type the following commands:**

`LOAD CDROM <Enter>`
`CD MOUNT NW411 <Enter>`
12. **Go to the workstation that is to become a server and log in to the host server with the mounted CD-ROM NetWare volume.**
13. **Map a drive to the mounted CD-ROM volume.**

For example:

`MAP N NW411 <Enter>`
14. **Continue with "Where to Go Next" on page 23.**

Install from a NetWare Volume Containing NetWare 4.11 CD-ROM Files

Necessary Resources



- An existing NetWare server with sufficient disk space (at least 170 MB) to store all the NetWare 4.11 operating system files--an image of the CD. (This will be the host server.)
- An existing NetWare workstation. (This will be the server you install.)

- A CD-ROM drive that can read ISO 9660 formatted CD-ROM disks.

This is used to copy the NetWare 4.11 files from the CD-ROM to the host server.

Procedure

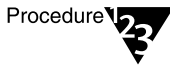

- 1. Create a NETWARE directory on an existing server and copy the files from the CD-ROM to that directory.**

For example, to copy from CD-ROM drive D: to network drive K:, type

```
K: <Enter>
MD NETWARE <Enter>
CD NETWARE <Enter>
NCPY D: /S /E /V <Enter>
```

- 2. On every computer you want to make a NetWare 4.11 server, create a DOS partition of at least 15 MB.**
- 3. On every computer you want to make a NetWare 4.11 server, install NetWare DOS client software.**
- 4. On every computer you want to make a NetWare 4.11 server, map a drive to the network server directory that contains the NetWare 4.11 files.**
- 5. Continue with “Where to Go Next” below.**

Where to Go Next

With the initial hardware preparation completed, you are ready to install the NetWare server.

If you want to	Go to
Install a new NetWare 4.11 server using the simple installation option	Chapter 2, "Simple Installation," on page 25
Install a new NetWare 4.11 server using the custom installation option	Chapter 3, "Custom Installation," on page 59
Install NetWare SFT III	Chapter 5, "Install NetWare 4.11 SFT III," on page 197

2 *Simple Installation*

The simple installation option allows you to easily install a NetWare® 4.11 server using a streamlined user interface.

The simple installation assumes that you have completed all prerequisites in Chapter 1 and that the following are true for your server:

Checklist



- An existing DOS partition of at least 15 MB on the hard disk.
A 15 MB DOS partition should be sufficient for storing the files used to boot your server. If you need to store additional files on the DOS partition, you may want to make the partition larger.
- DOS is installed on the DOS partition.
- The server will boot from a DOS partition on the hard disk, rather than from floppy boot diskettes.
- Hard disks (including hard disk subsystems, if any), won't be mirrored or duplexed.
- All hard disk space not allocated to the DOS partition will be allocated to NetWare.
- Each disk will contain one NetWare volume.
- A randomly generated IPX internal network number.
- A default Novell Directory Services hierarchy with a single container for all objects.

If the "Simple Installation" option isn't possible in your environment, follow the procedures in "Custom Installation" on page 59.

Suggested Resources



- The NetWare Server Installation quick path card for an overview of the installation process.
- A copy of the NetWare 4.11 Server Worksheet (found in Figure 3-42 on page 141).
- The NetWare *License* diskette.
- One* of the following:
 - ◆ NetWare 4.11 CD-ROMs.
 - ◆ Access to NetWare 4.11 installation files on a remote network installation area (the *NetWare 4.11 Operating System* CD-ROM mounted as a NetWare volume, or an image of the CD-ROM on another server).

Install Server Software

Install your NetWare 4.11 server software by completing the procedures in Chapter 1 and then continuing with the table and the procedures below.



Before you install, be sure that the logical name of your CD-ROM driver in the AUTOEXEC.BAT file does not conflict with any Install file names. If you have changed the name of your CD-ROM driver to "Install" or to the name of any file that Install copies, Install will not work.

If you are installing from	You should be at
CD-ROM	The drive letter corresponding to the CD-ROM.
CD-ROM mounted as a NetWare volume	The drive letter mapped to the mounted CD-ROM volume on the workstation that is to become a server.
A NetWare volume with files copied on the server	The drive letter mapped to the network server directory that contains the NetWare 4.11 files.



Procedure

1. Run Install.

If	Then
You want to enable hardware autodetection and automatic selection of drivers (For more information on autodetection, see “Load the Device Drivers” on page 31 or “Load the LAN Drivers” on page 34.)	At the mapped drive letter, type INSTALL <Enter>
You want to disable hardware autodetection and automatic selection of drivers	At the mapped drive letter, type INSTALL /nad <Enter>

A menu similar to the one below appears:

Figure 2-1
Choose the Desired
Server Language



2. Choose the language in which you want the server installed and press <Enter>.

The “Select the Type of Installation Desired” menu appears.

Choose the Type of Installation

You can choose from four installation options as shown in Figure 2-2 below.

Figure 2-2
Choose the Type of
Installation



If	Then
You want to install the NetWare server	Choose "NetWare Server Installation." Continue with "Name Your Server and Copy Boot Files" below.
You want to install Clients	Choose "Client Installation." A screen appears allowing you to install the Client 32 Administrative Utility and a number of clients. Choose the option you want to install and follow the screen prompts. Note: You can also install the Client 32 Administrative Utility and any of these clients later under the heading "Other Installation Options (Optional)" on page 53, or after you finish the server installation by running the INSTALL.NLM.

If	Then
You want to create diskettes	<p>Choose “Diskette Creations.”</p> <p>A screen appears allowing you to create diskettes for the Client 32 Administrative Utility and a number of clients.</p> <p>Choose the option for which you want to create diskettes and follow the screen prompts.</p> <p>Note: You can also install the Client 32 Administrative Utility and any of these clients later under the heading “Other Installation Options (Optional)” on page 53, or after you finish the server installation by running the INSTALL.NLM.</p>
You want to read the ReadMe files	Choose “ReadMe Files.”

Name Your Server and Copy Boot Files

Once you’ve chosen the language in which the server will be installed, the following menu appears:

```

NetWare 4.11
NetWare 4.11 SFT III
Display Information (README) File

```

Procedure

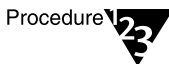

1. **Choose “NetWare 4.11” and press <Enter>.**
A menu appears displaying additional installation options.
2. **Choose “Simple Installation of NetWare 4.11” and press <Enter>.**
A screen appears requesting a server name.
3. **Type the server name in the field provided and press <Enter>.**

For help on rules for naming servers, press <F1>.

The server boot files are copied to the server.

- 4. Unless you have multiple processors, continue with “Load the Device Drivers” on page 31. If you have multiple processors, continue with “Install NetWare SMP (Conditional)” below.**

Install NetWare SMP (Conditional)

Symmetric MultiProcessing (SMP) allows multiprocessing-enabled NetWare Loadable Modules (NLMs) to run across multiple processors and take advantage of the increased processing power they provide. For more information about SMP, please see *Supervising the Network*.

When SMP is installed, three lines are added to your STARTUP.NCF file:

```
Load [name of your Platform Support Module (PSM)] (All  
PSM's will have a .PSM extension.)
```

```
Load SMP.NLM
```

```
Load MPDRIVER.NLM ALL
```

If you have symmetrical multiprocessors, and you have chosen to run Install with autodetection enabled, Install detects the multiple processors and presents the message below.

```
"Do you want to install Symmetrical Multi-processing  
NetWare (SMP)?"
```

Procedure

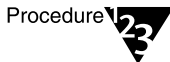

- 1. Choose “Yes” or “No.”**

If you choose “No,” you can install SMP another time through INSTALL.NLM.

If you choose “Yes,” Install attempts to find the Platform Support Module (PSM) files to load. If found, these drivers are displayed in a list.

2. Choose a PSM driver appropriate for your computer.

The drivers found are displayed in a list in Figure 2-3 below. If the list is empty or if the driver you need is not displayed, Install was unable to detect any PSM drivers. Press <Insert> to install the appropriate drivers from another location, such as from a floppy diskette or from another server.

Figure 2-3

Choose Your PSM Driver

COMPAQ.PSM	Platform Support Module for COMPAQ ProLiant
CPQPSM.PSM	Compaq SMP Platform Specific Module
CPQSMP.PSM	Compaq SMP Platform Specific Module
MPS14.PSM	Platform Support Module for INTEL MPS

If your PSM drivers are found on the CD, SMP is installed automatically and you can continue with “Load the Device Drivers” below.

If you specified another location from which to install your PSM drivers, you need to select the appropriate driver and respond “Yes” when Install asks whether to save the existing file.

3. Continue with “Load the Device Drivers” below.

Load the Device Drivers

Install automatically detects the hardware devices on your machine, including hard disks, CD-ROM drives, LAN cards, etc. It then scans for and selects applicable drivers for the hardware.

If	Then
Drivers are selected automatically	Proceed with “Load the LAN Drivers” on page 34. After the LAN drivers are loaded, a summary of selected drivers appears in Figure 2-6 on page 38. You can then continue with the drivers shown or you can modify the choices that have been made for you.

If	Then
Drivers are not selected automatically, or if Install found more than one driver for your hardware or was unable to match a hardware device with a driver	Continue without choosing a driver or choose manually which driver to load by following the process below.

Your drivers might not be selected for the following reasons:

- ◆ Your machine does not have an advanced bus (EISA, PCI, PNPISA, MCA).
- ◆ Your hardware is non-Plug and Play ISA.
- ◆ The drivers you need are not included with this release, or they do not contain information needed by the autodetection process.

If you need to choose your drivers manually, the driver selection screen shown below appears:

Figure 2-4
Choose Your Disk Driver

Select a driver:	
ASPICD.DSK	Adaptec CD-ROM (ASPI Compatible) Driver
ASPITRAN.DSK	Adaptec NetWare ASPI Transport Layer
IDEATA.HAM	Novell IDE (ATA/ATAPI Compatible) Host Adapter Module (HAM)
SCSI154X.HAM	Adaptec AHA-1540/42 Reference HAM Module
TAPEDAI.DSK	NetWare 386 Tape Device Driver

If Install found more than one driver for your hardware or was unable to match a hardware device with a driver, a message informs you of the problem and allows you either to continue without choosing a driver or to choose which driver to load.

If you choose a driver to load, the process is the same as the manual selection process described below.



If you are installing from CD-ROM and the CD-ROM drive is connected to a SCSI adapter shared by another internal or external device (hard disk, tape device, etc.), you may experience a keyboard lockup problem while loading drivers or copying files. If this occurs, contact your SCSI adapter manufacturer for updated drivers.

Similar to a disk driver, a CD-ROM driver enables communication between the CD-ROM and the server's CPU. In some cases, you must choose a CD-ROM driver as well as a disk driver.

Disk drivers have a description that appears as you highlight the driver. A list of standard Novell® drivers is shown in Table 2-1.

Table 2-1
Standard Novell Disk Drivers

Computer architecture	Controller	Disk driver you must load
Industry Standard Architecture (ISA)	AT	ISADISK
	IDE (ATA)	IDE
Microchannel	ESDI	PS2ESDI
	IBM SCSI	PS2SCSI
Extended Industry Standard Architecture (EISA)	AT class	ISADISK
	IDE (ATA)	IDE
	EISA vendor proprietary	See vendor

For example, if you have an ISA computer, load the IDE disk driver.

Besides Novell drivers, additional third-party drivers are included with NetWare 4.11.



If you experience problems with third-party drivers, contact the manufacturer listed in the driver description that appears as you highlight the driver.

Procedure

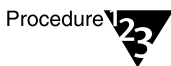

1. Choose your disk driver.

The selected disk driver is then copied to the server boot directory before it is loaded.

If more than one hard disk of the same type is installed in your computer, and if the disks are both connected to the same disk controller, load only one disk driver for that controller.

If the disks are connected to different controllers, load the driver multiple times or load additional disk drivers.

If	Then
The driver is listed	Choose the appropriate disk driver and continue with Step 2.
The driver is not listed	Press <Ins> and follow the prompts. Then continue with "Load the LAN Drivers" below.

2. Verify that the displayed parameter settings are correct.

A prompt appears asking you either to choose and modify driver parameters or to continue and save the displayed parameters.

If you continue and save the displayed parameters, another prompt appears asking if you want to load any additional drivers.

If you want to	Then
Load additional disk drivers, or load separate CD-ROM drivers	Choose "Yes" and press <Enter>. Then repeat Step 1 and Step 2.
Proceed without loading additional disk drivers	Continue with "Load the LAN Drivers" below.

Load the LAN Drivers

Install automatically detects the hardware devices on your machine, including hard disks, CD-ROM drives, LAN cards, etc. It then scans for and selects applicable drivers for the hardware.

If	Then
Drivers are selected automatically	Go to the summary of selected drivers shown in Figure 2-6 on page 38. You can then continue with the drivers shown or you can modify the choices that have been made for you.

If	Then
Drivers are not selected automatically, or if Install found more than one driver for your hardware or was unable to match a hardware device with a driver	Continue without choosing a driver or choose manually which driver to load by following the process below.

Your drivers might not be selected for the following reasons:

- ◆ Your machine does not have an advanced bus (EISA, PCI, PNPISA, MCA).
- ◆ Your hardware is non-Plug and Play ISA.
- ◆ The drivers you need are not included with this release, or they do not contain information needed by the autodetection process.

Loading a LAN driver is needed to establish a network connection (if the server is physically connected to the network cabling). Your choice of LAN drivers depends on the cabling system and the network board you are using.

Most NetWare 4.11 LAN drivers have an individual description that appears on the screen when you choose the driver. Refer to Table 2-2 and to the on-screen descriptions to determine which LAN driver to load.



If you experience problems with third-party drivers, contact the manufacturer listed in the driver description that appears as you highlight the driver.

Table 2-2
Novell LAN Drivers

Cabling system	Network board	LAN driver you must load
ARCnet*	RX-Net	TRXNET.LAN
	RX-Net II	
	RX-Net/2	
Ethernet	NE/2 NE/2T	NE2.LAN

Table 2-2 continued

Novell LAN Drivers

Cabling system	Network board	LAN driver you must load
	NE/2-32	NE2_32.LAN
	NE1000 - ASSY 950-054401 NE1000 - ASSY 810-160-001	NE1000.LAN
	NE2000 - ASSY 810-149 NE2000T - ASSY 810-000220	NE2000.LAN
	NE2100 - ASSY 810-000209	NE2100.LAN
	NE1500T - ASSY 810-000214 (twisted-pair version of NE2100)	NE1500T.LAN
	NE3200	NE3200.LAN
	NE32HUB	NE32HUB.LAN
Token Ring	NTR2000	NTR2000.LAN

For example, if you have a Novell NE2100™ network board installed in your computer, you must load the NE2100.LAN driver.

Procedure

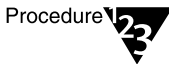

1. **Choose your LAN driver from the LAN driver screen in Figure 2-5 below.**

If the LAN drivers are not selected and loaded automatically, the screen in Figure 2-5 below appears. The selected LAN driver is then copied and stored temporarily in the C: drive before it is loaded.

Figure 2-5
Choose Your LAN Drivers

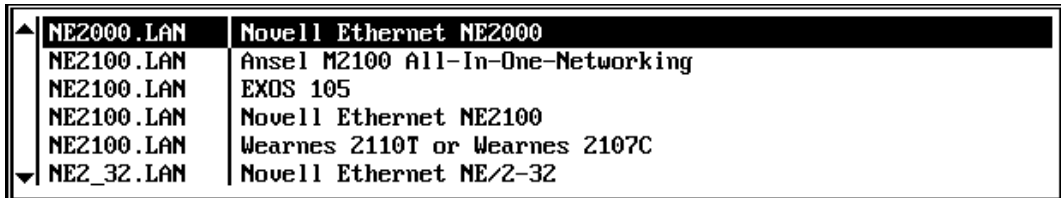

If	Then
The driver is listed	Choose the appropriate LAN driver and continue with Step 2.
The driver is not listed	Press <Ins> and follow the prompts. Then continue with Step 2.

2. Verify that the displayed LAN driver parameter settings are correct.

A prompt appears asking you either to choose and modify driver parameters or to continue and save the displayed parameters. You can modify the driver frame types by pressing <F3>.

If you continue and save the displayed parameters, another prompt appears asking if you want to load any additional drivers.

If you want to	Then
Load additional LAN drivers	Choose "Yes" and press <Enter>. Then repeat Step 1 and Step 2.
Proceed without loading additional LAN drivers	Continue with Step 3.

3. Verify selected Disk/LAN drivers.

If your drivers are automatically selected, the screen in Figure 2-6 below appears displaying the selected disk and LAN drivers, and a prompt asks you to select additional or modify selected Disk/LAN drivers or to continue the installation.

Verify that there is at least one disk driver per controller and one LAN driver per LAN adapter. Take into account controllers and adapters that are integrated into the computer's CPU and those on the computer's expansion cards.

Figure 2-6
Chosen Drivers Are Displayed Prior to Being Loaded

	Driver Names
Disk and CD-ROM Drivers:	>IDEATA, IDEHD
Network (LAN) Drivers:	>NE2000

Driver Actions
Select additional or modify selected Disk/LAN drivers Continue installation

If you want to	Then
Load additional drivers or modify the settings of any previously selected drivers	Choose "Select Additional or Modify Selected Disk/LAN Drivers," and follow the screen prompts, repeating Step 1 through Step 3. Once all appropriate network drivers have been chosen, continue with Step 4 below.
Proceed without loading additional drivers	Continue with Step 4.

4. From the "Driver Actions" menu in Figure 2-6, choose "Continue Installation."

At this time, NetWare 4.11 loads the drivers that have been chosen. In the case of LAN drivers, all frame types are loaded and applicable frames bound to IPX.

Mount the CD-ROM as a NetWare Volume (Conditional)

If you are installing from CD-ROM, the screen in Figure 2-7 appears if the CD-ROM device is not available to NetWare.



Figure 2-7
You Can Try to
Mount the CD-ROM
as a NetWare
Volume

Procedure

1. **(Conditional)** If you are installing from CD-ROM and the menu in Figure 2-7 appears, choose one of the menu options.

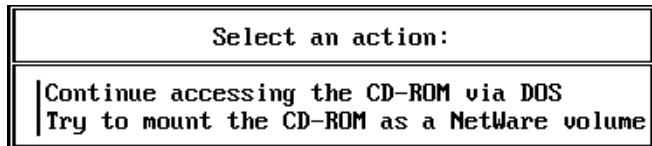

If a disk or CD-ROM driver you selected earlier conflicts with the DOS CD-ROM driver, your keyboard may lock up during installation. To avoid this, you can attempt to mount the CD-ROM as a NetWare volume. In doing so, you might be prompted to install new disk or CD-ROM drivers.

2. Continue with “Create the NetWare Disk Partition” below.

Create the NetWare Disk Partition

Every NetWare 4.11 server needs a disk partition for NetWare files and shared data. You can have only one NetWare 4.11 disk partition per disk, but you can have up to eight volume segments on the NetWare disk partition. In the process below, you choose to delete or retain nonbootable disk partitions. Install then automatically creates a NetWare disk partition.

Note





If your server’s hard disk contains existing nonbootable disk partitions, a message appears telling you so.

Decide whether you want to delete existing nonbootable disk partitions and make them part of the NetWare partition, or save them and exclude them from being part of the NetWare partition.

If your server’s primary hard disk has a DOS partition, use the rest of the disk space as a NetWare disk partition.

Figure 2-8
Disk Partitions and
Volumes on an
Internal Hard Disk

 NetWare disk partition
 DOS partition

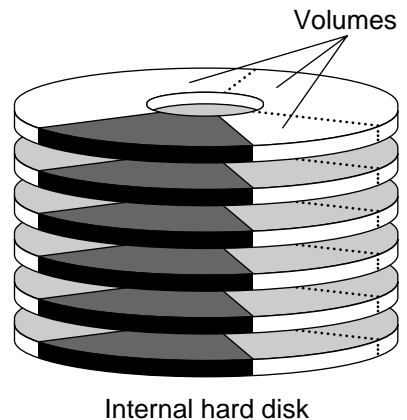

Procedure

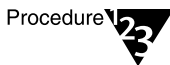

1. **(Conditional) If prompted whether to delete existing nonbootable partitions, choose “Yes” or “No” and press <Enter>.**



Selecting “Yes” deletes any extended DOS partitions you may have.



To maximize your NetWare disk partition space, delete all nonbootable disk partitions. Press <Alt>+<F10> to exit the installation, then back up any files you want to keep and start the installation again.

2. **If you are installing from a network volume, continue with “Establish the Server-to-Server Session (Conditional)” below; otherwise, continue with “Install Novell Directory Services” on page 42.**



When installing from a remote network, you must establish the server-to-server session before files are copied.

Establish the Server-to-Server Session (Conditional)

If you are installing from a remote network installation area, the screen shown in Figure 2-9 appears:

Figure 2-9
Enter Your
Password to
Reconnect to the
Source Server

User Name: FSMITH
Password: <input type="password"/>
Press <Enter> to continue and log in

Procedure

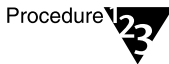

1. **Reenter your password to reconnect to the source server, and press <Enter>.**

When installing from a remote network installation area, a client connection to the source server is disrupted once the LAN driver is loaded.

The path to the source server is saved in memory, but the password must be reentered.

2. **Press <Enter> again.**

The copying process begins, and the screen in Figure 2-10 appears:

Figure 2-10
The Files Needed to Continue are Copied

<p style="text-align: center;">File Copy Status (Preliminary Copy)</p> <div style="text-align: center;"> 37%</div> <p>Filegroup: NetWare System Files Source path: D:\NW411\INSTALL\ENGLISH Destination path: SYS:\PUBLIC\NLS\ENGLISH</p> <div style="border: 1px solid black; padding: 5px;"><p>→ Copying file "DSI.NLM" → Copying file "FILTSRV.NLM" → Copying file "ICMD.NLM" → Copying file "INETLIB.NLM" → Copying file "INSTALL.NLM" → Copying file "IPTUNNEL.LAN" → Copying file "IPTUNNEL.LDI"</p></div>
--

3. Continue with “Install Novell Directory Services” below.

Install Novell Directory Services

Once the preliminary files have been copied to the server, the network is scanned for Directory trees. Unless you are installing the first NetWare 4 server in the network, you will most likely want to install the server into an existing Directory tree.

Based on your network configuration, one of the following screens appears:

Figure 2-11
When No Directory
Tree Is Located

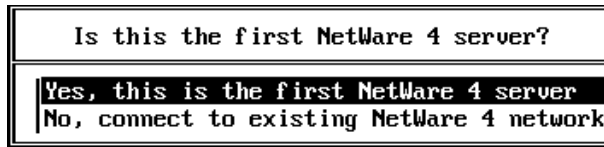

If no NetWare 4 server (and accompanying Directory tree) can be located on the network, the menu above appears.

If you want to	Then
Install the first NetWare Server	Go to “Install the First NetWare 4 Server” on page 43.
Connect to an existing NetWare 4 network	Go to “The Server Cannot Locate a Previously Installed Directory Tree” on page 45.

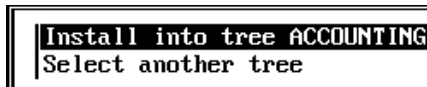

If a single Directory tree is located, the Directory tree name is displayed as in the menu above.

If you want to	Then
Install into the displayed directory tree	Go to “Install into the Single Existing Directory Tree” on page 46.

If you want to	Then
Select another tree	Go to "Install the First NetWare 4 Server" on page 43.
Create a new directory tree	Choose "Select another tree" and press <Enter>. Press <Ins>, and then at the confirmation prompt, press <Enter>. Follow the procedures under "Install the First NetWare 4 Server" on page 43.

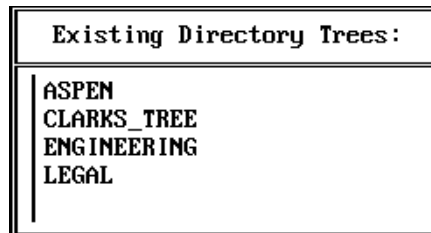

If multiple Directory trees are located, they are displayed as in the menu above. If you want to install into one of the existing Directory trees, go to "Install into an Existing Directory Tree" on page 48.

Install the First NetWare 4 Server

Procedure

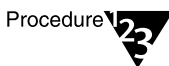

1. From the "Is this the First NetWare 4 Server?" menu, choose "Yes, This Is the First NetWare 4 Server" and press <Enter>.

A list of time zones appears.

2. Choose the time zone where the server will be installed and press <Enter>.

The following screen appears, requesting your Novell Directory Services (NDS) Organization name:

Organization Name:

If	Then
The time zone is listed	Move the cursor to the time zone and press <Enter>.
The time zone is not listed	Press <Ins> and fill out the "Verify/Enter Time Configuration Information for This Server" screen. Note: An explanation of this screen can be found in Chapter 3, "Custom Installation" under the heading "Set Up Time Synchronization" on page 112, beginning with Step 2. Once entered, continue with Step 3 below.

3. Enter the name of your organization and press <Enter>.

Your NDS Organization name can be your company, division or department name. It is also the name of your Directory tree.

Once you have entered the NDS Organization name and pressed <Enter>, a screen appears requesting your administrator password.

4. Enter the administrator password and press <Enter>.

You need this password later to log in and administer the network. If you forget the administrator password, you must reinstall.



This password is initially set the same as the password for the bindery user SUPERVISOR. If you change the administrator password later, the SUPERVISOR password does *not* change until you change it using either the NETADMIN or NWADMIN utility.

5. At the prompt, retype the password and press <Enter> to continue.

6. Go to "Install the License Server" on page 50.

The Server Cannot Locate a Previously Installed Directory Tree

Procedure

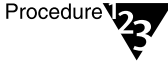

1. From the “Is This the First NetWare 4 Server?” menu, choose “No, Connect to Existing NetWare 4 Network” and press <Enter>.

The following menu appears:

Figure 2-12
Select NetWare 4
Network Menu

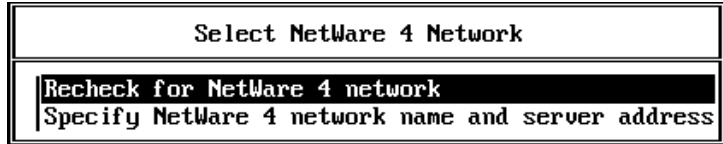

You can find out the network name by loading MONITOR.NLM on an existing server on the network. The network name is the same as the Directory tree name.

2. Choose one of the menu options.

If	Then
You have verified that an existing NetWare 4 server is up and physically connected to the network, and that both servers are bound to IPX with the proper LAN driver, frame type, and IPX external network number	Choose “Recheck for NetWare 4 Network” and press <Enter>.
	If a single Directory tree is located, go to “Install into the Single Existing Directory Tree” on page 46.
	If multiple Directory trees are located, go to “Install into an Existing Directory Tree” on page 48.

If	Then
Your network has SAP filtering and you know the IPX internal network number of an existing NetWare 4 server	<p>Choose "Specify NetWare 4 network name and server address" and press <Enter>.</p> <p>Enter the name of the Directory tree and press <Enter>.</p> <p>Enter the IPX internal network number of an existing NetWare 4 server in the Directory tree and press <Enter>.</p> <p>If a single Directory tree is located, go to "Install into the Single Existing Directory Tree" on page 46.</p> <p>If multiple trees are located, go to "Install into an Existing Directory Tree" on page 48.</p>

Install into the Single Existing Directory Tree

Install the new NetWare 4.11 server into the Directory tree displayed in the menu below:

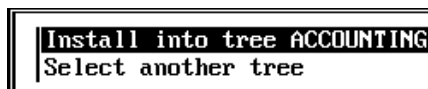

Procedure

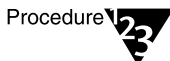

1. Choose "Install into Tree *tree name*" and press <Enter>.

A list of time zones appears.

2. Choose the time zone where the server will be installed and press <Enter>.

If	Then
The time zone is listed	<p>Move the cursor to the time zone and press <Enter>.</p> <p>Once entered, continue with Step 3 below.</p>

If	Then
The time zone is not listed	<p>Press <Ins> and fill out the “Verify/Enter Time Configuration Information for This Server” screen.</p> <p>Note: An explanation of this screen can be found in Chapter 3, “Custom Installation” under the heading “Set Up Time Synchronization” on page 112, beginning with Step 2.</p> <p>Once entered, continue with Step 3 below.</p>

After setting up time synchronization, the screen below appears:

Figure 2-13

Directory Services Login/Authentication

Directory Services Login/Authentication
Administrator Name: CN=Admin.O=Novell Password:

3. If necessary, type the administrator name and press <Enter>, and then type the administrator password and press <Enter>.

A server (name) context screen appears:

Figure 2-14

Server Context Screen for an Existing Tree

Company or Organization: NOVELL Level 1 (Sub)Organizational Unit (optional) Level 2 (Sub)Organizational Unit (optional) Level 3 (Sub)Organizational Unit (optional) Server Context: NOVELL
--

4. Specify the server’s name context by filling out the screen above.

An explanation of this screen and of a server’s (name) context is found in Chapter 3 “Custom Installation” under “Specify the Server’s (Name) Context” on page 117.

5. Continue with “Install the License Server” on page 50.

Install into an Existing Directory Tree

Install the new NetWare 4.11 server into one of the Directory trees displayed in the menu below by completing the following procedures:

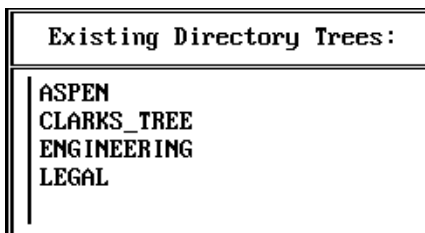

Procedure



- 1. Choose the Directory tree you want this server to be part of.**

A list appears of all Directory trees that are visible from this server. Most organizations will have only one Directory tree. The tree name is established during the installation of the first NetWare 4.11 server in a tree.



Make sure you choose the correct Directory tree name. If your organization has more than one tree, attaching to the wrong tree or creating a new Directory tree will prevent this server from sharing data within the desired Directory database.

Choosing an existing tree makes this new server part of that tree's Novell Directory database.

After you choose a Directory tree, a list of time zones appears.

- 2. Choose the time zone where the server will be installed and press <Enter>.**

If	Then
The time zone is listed	Move the cursor to the time zone and press <Enter>. Once entered, continue with Step 3 below.

If	Then
The time zone is not listed	<p>Press <Ins> and fill out the “Verify/Enter Time Configuration Information for This Server” screen.</p> <p>Note: An explanation of this screen can be found in Chapter 3, “Custom Installation” under the heading “Set Up Time Synchronization” on page 112, beginning with Step 2.</p> <p>Once entered, continue with Step 3 below.</p>

After setting up time synchronization, the screen below appears:

Figure 2-15

Directory Services Login/Authentication

Directory Services Login/Authentication
Administrator Name: CN=Admin.O=Novell Password:

- If necessary, type the administrator name and press <Enter>, and then type the administrator password and press <Enter>.

A server (name) context screen appears:

Figure 2-16

Server Context Screen for an Existing Tree

Company or Organization: NOVELL Level 1 (Sub)Organizational Unit (optional) Level 2 (Sub)Organizational Unit (optional) Level 3 (Sub)Organizational Unit (optional) Server Context: NOVELL
--

- Specify the server’s name context by filling out the screen above.

An explanation of this screen and of a server’s (name) context is found in Chapter 3 “Custom Installation” under the heading “Specify the Server’s (Name) Context” on page 117.

- Continue with “Install the License Server” below.

Install the License Server

After Directory Services has been installed, the screen below appears, prompting you to insert the license diskette and install the NetWare 4.11 license server.

Figure 2-17
Insert the *License* Diskette when Prompted

```
The license file will be installed from drive A:. Insert disk "MAIN
SERVER LICENSE" (which contains the file "SERVER.MLS") into the drive.

Warning: Do not try to install this same license on any
other server.
Doing so will cause a copyright violation warning to be issued.

Press <F3> to specify a different path;
Press <Enter> to continue.
```

Procedure

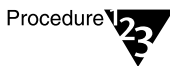

1. Insert your *License* diskette into drive A:.

A message appears that the server license was successfully installed. As you continue the installation, a prompt to log in as a network administrator or the equivalent appears.

2. Remove the *License* diskette and store it in a safe place.



Be sure to keep your *License* diskette as a backup. You may need it in the future if your installed license should get corrupted.

Copy Remaining NetWare Files

Once Novell Directory Services has been installed, NetWare begins copying the remaining NetWare files to volume SYS: as shown in Figure 2-18. The simple installation option copies all NetWare 4.11 files during installation; therefore, this could take a few minutes.

Figure 2-18
The Remaining NetWare Files Are Copied

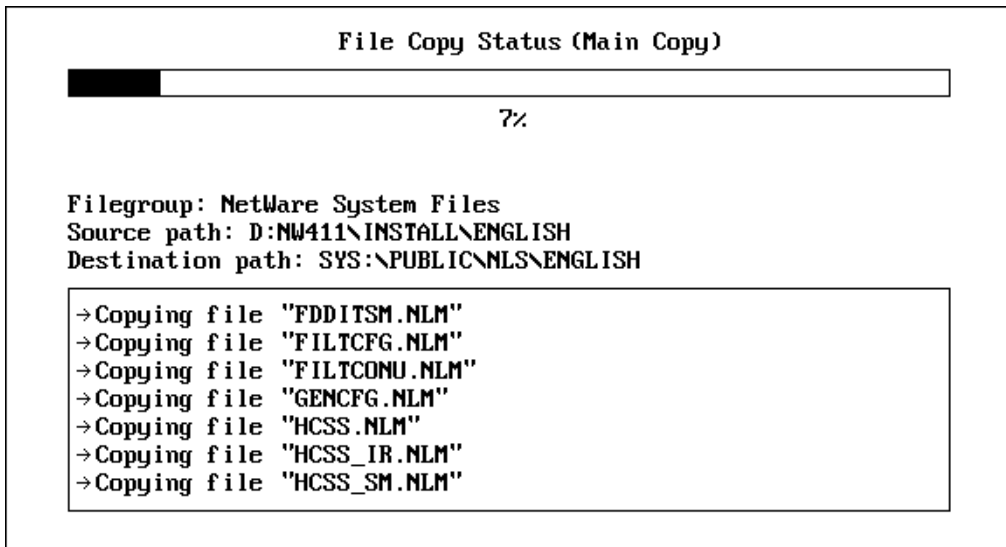

While the remaining NetWare files are being copied, you can

- ◆ Continue with "Review the Created Directory Tree (Optional)" on page 52 and "Review the Created Trustee Assignments (Optional)" on page 52.
- ◆ Continue with "Other Installation Options (Optional)" on page 53, or skip to "Exit Install" on page 57.

Review the Created Directory Tree (Optional)

The following objects were created in the Directory tree:

- ◆ Server object.
- ◆ Volume objects (*servername_SYS* and other volumes you specified).
- ◆ User object ADMIN (the administrator who has Supervisor object rights to this context). This object is placed directly under the Organization level.



User object ADMIN is created only once, and only on the first server in the tree.

- ◆ User object Supervisor (for bindery services purposes only). This object is recognized only by pre-NetWare 4.11 utilities. User object Supervisor takes on User object ADMIN's password.

These objects are placed in the same context you defined for your server. The following illustration shows what your Directory tree might look like after you install your first NetWare 4.11 server.

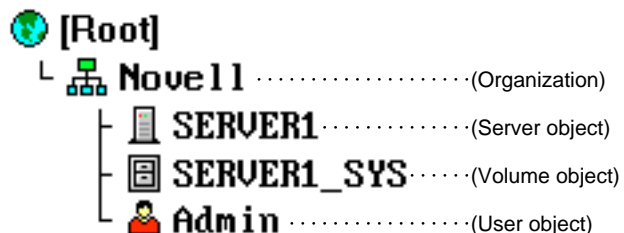

Review the Created Trustee Assignments (Optional)

- ◆ User object ADMIN has the Supervisor object right on the [Root] object. By inheritance, ADMIN also has the Supervisor right on all Volume objects in the Directory.
- ◆ [Public] has the Browse right on the [Root] object.



[Public] is equal to the group EVERYONE in the NetWare 3 environment.

- ◆ Any container object has Read and File Scan rights to the PUBLIC directories of all system volumes in that container.
- ◆ The [Root] object (or security equivalent) of a tree has
 - ◆ The Browse right on all User objects in that tree. This can be blocked by an Inherited Rights Filter or removed from a container's Access Control List (ACL).
 - ◆ The Read right to the Member property of any Group object.
 - ◆ The Read right to the following properties of any Volume object: Host Server Name (the server that the physical volume resides on) and Host Resource (the physical volume).
- ◆ All User objects have the Read right to their own properties and to the properties of any profile they belong to. User objects also have Read and Write rights to their user login script.

For more information on rights and trustee assignments, see "Rights" and "Trustee" in *Concepts*, and Chapter 2, "Managing Directories, Files, and Applications," and Chapter 3, "Creating Login Scripts," in *Supervising the Network*.

Other Installation Options (Optional)

Once all NetWare files have been copied to volume SYS:, a screen appears listing two other available installation options:

- ◆ Create a Registration Diskette
- ◆ Make Diskettes

These and other options can be done any time from the server by loading INSTALL.NLM at the server console.

If	Then
You want to perform any of the listed installation actions at this time	Follow the procedures under the heading below that corresponds to the option you choose.

If	Then
You do not want to perform any of the listed installation actions at this time	<p>Choose “Continue Installation” from the “Other Installation Actions” menu and press <Enter>.</p> <p>After being prompted that the installation is complete, press <Enter> to access the server console.</p> <p>Go to “Where to Go from Here” on page 57.</p>

Create a Registration Diskette

Having a *Registration* diskette is useful in case you experience system problems in the future and must call Novell Technical SupportSM.

Install can read information such as OS version, addresses, number of licensed connections, SFT level, amount of RAM installed, network board configuration, and disk drive configuration, and it can copy this information to the *Registration* diskette.

Novell support technicians can access the above information, which greatly speeds up their ability to help you.

Procedure

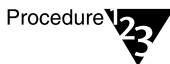

1. From the “Other Installation Actions” menu, select “Choose an Item or Product Listed” and press <Enter>.
2. Choose “Create a Registration Diskette” and press <Enter>.

The screen that appears lists three prerequisites:

- ◆ The NetWare 4.11 *Registration* diskette
- ◆ The name and address of your Novell Authorized Reseller^{CLM}
- ◆ Your company’s reseller contact (the person in your company in responsible for purchases).

3. Press <F10> to continue.

4. In the “Reseller Information” form that appears, fill in the name and address of the Novell Authorized Reseller you purchased NetWare 4.11 from.
 - 4a. Press <Enter> after each entry.
 - 4b. Press <F10> to continue.
5. In the “Customer Information” form, fill in the reseller contact’s name and the name of your company (or organization).
 - 5a. Press <Enter> after each entry.
 - 5b. Press <F10> to continue.
6. Insert the *Registration* diskette into drive A: and press <Enter>.Install now copies the registration information to this diskette.
7. (Optional) Copy configuration information to the *Registration* diskette.
 - 7a. Press <F2> to view configuration information.
 - 7b. Press <Esc> to exit the screen.
 - 7c. When asked “Copy This Information to the Diskette?” choose “Yes” or “No.”
 - 7d. Insert the *Registration* diskette into the mailer labeled “Product Registration” and send it to Novell.
8. Continue performing any additional installation options listed under “Other Installation Options (Optional)” on page 53, or go to “Exit Install” on page 57.

Make Diskettes

This option allows you to make diskettes necessary to upgrade an existing NetWare 2.x, 3.x, or 4.x server to NetWare 4.11.

This option also allows you to make client diskettes. If you don’t want to make client diskettes at this time, you can make them later from the server by loading INSTALL.NLM or from a workstation by running

MAKEDISK.BAT as explained in Appendix E, “Creating Client Diskettes,” on page 233.

Prerequisites

To make client diskettes, format the appropriate number of high-density diskettes as prompted by the screen or as shown in Table 2-3 below.

Table 2-3
Formatted Diskettes for Clients

For	Format
NetWare Client 32 Administrative Utility	Two 3.5 or 5.25 inch diskettes.
NetWare DOS/Windows Client (VLM)	Five 3.5-inch or 5.25 inch diskettes.
NetWare DOS/Windows Client (VLM) for IP	Five 3.5-inch or 5.25 inch diskettes.
NetWare Client 32 for DOS and Windows 3.1x	Five 3.5-inch or 5.25 inch diskettes.
NetWare Client 32 for Windows 95	Five 3.5-inch or 5.25 inch diskettes.
NetWare Client for OS/2	Eleven 3.5-inch or 5.25 inch diskettes.

Procedure

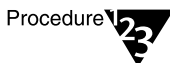

1. **From the “Other Installation Actions” menu, select “Choose an Item or Product Listed Above” and press <Enter>.**
2. **Choose “Make Diskettes” and press <Enter>.**

A menu appears showing a list of clients similar to the list in Table 2-3 above.
3. **Select or deselect the clients you want to copy to diskette by pressing <Enter>.**
4. **Press <F10> to accept the marked clients and continue.**
5. **Specify the destination that the client files will be copied to.**

By default, the client files are copied to drive A:. To specify a new path, press <F3> and type the new path.

6. **Press <Enter> to accept the path.**
7. **Insert the labeled diskettes as prompted.**
8. **Continue performing any additional installation options, or go to “Exit Install” below.**

Exit Install

The installation of the NetWare 4.11 server is now complete.

Procedure

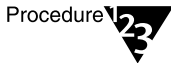

1. **To exit Install and return to the server console, press <Enter>.**
2. **Continue with “Where to Go from Here” below.**

Where to Go from Here

If you want to	Go to
Install additional NetWare 4.11 servers	“Install Server Software” on page 26.
Install NetWare SFT III	Chapter 5, “Install NetWare 4.11 SFT III,” on page 197.

This chapter provides complete instructions for you to customize your installation of NetWare[®] 4.11 by allowing you to change the defaults for any of the following configuration options:

Checklist



- Booting the server from boot diskettes or a DOS partition on the hard disk
- Assigning a specific internal network number yourself
- Partitioning hard disks
- Mirroring hard disks
- Specifying volume names
- Spanning volumes across multiple drives
- Modifying time zone parameters in Novell Directory Services™
- Editing the AUTOEXEC.NCF and STARTUP.NCF files
- Choosing nonrouting TCP/IP or AppleTalk* protocols in addition to IPX™

If you determine that you don't need any of the options listed above, install NetWare 4.11 by following the procedures in Chapter 2, "Simple Installation" on page 25.

Suggested Resources



- The NetWare Server Installation quick path card for an overview of the process.
- A copy of the NetWare Server Worksheet (Figure 3-42 on page 141).
- The NetWare *License* diskette.
- One of the following:
 - ◆ NetWare 4.11 CD-ROMs.
 - ◆ Access to NetWare 4.11 installation files on another server (the *NetWare 4.11 Operating System* CD-ROM mounted as a NetWare volume, or an image of the CD-ROM on another server).

Choose a Server Boot Method

In most cases, proper physical security measures, combined with the security features in NetWare 4.11, should be sufficient for your security needs.

Though not typically recommended, as a possible additional security measure, you can make the server bootable from a pair of diskettes, rather than from a DOS partition on the hard drive. You can then store the boot diskettes in a secure place and be assured that no one but you can boot the server.

To boot your server from	Continue with
A DOS partition on the hard disk	"Install the Server Software" below.
Floppy diskettes	Appendix D, "Install To Boot From Floppy Diskette," on page 231.

Install the Server Software

Install your NetWare 4.11 server software by completing the procedures outlined in Chapter 1 and by following the table and procedures below.

Note



Before you install, be sure that the logical name of your CD-ROM driver in the AUTOEXEC.BAT file does not conflict with any Install file names. There will be no conflict unless you have changed the name of your CD-ROM driver. If you have changed the name of your CD-ROM driver to "Install" or to the name of any file that Install copies, Install will not work.

If you are installing from	You should be at
CD-ROM	The drive letter corresponding to the CD-ROM.
CD-ROM mounted as a NetWare volume	The drive letter mapped to the mounted CD-ROM volume on the workstation that is to become a server.
a NetWare volume with files copied on the server	The drive letter mapped to the network server directory that contains the NetWare 4.11 files.

Procedure

Procedure



1. Run Install.

If	Then
You want the filename format to default to DOS, and you want to enable hardware autodetection and automatic selection of drivers (For more information on autodetection, see "Load the Device Drivers" on page 70 or "Load the LAN Drivers" on page 73.)	At the mapped drive letter, type INSTALL <Enter>
You want to choose the filename format (DOS or NetWare)	At the mapped drive letter, type INSTALL /file_sys <Enter>
You want to disable hardware autodetection and automatic selection of drivers	At the mapped drive letter, type INSTALL /nad <Enter>

If	Then
You want to choose the filename format (DOS or NetWare), and you want to disable hardware autodetection and automatic selection of drivers	At the mapped drive letter, type <code>INSTALL /file_sys /nad <Enter></code>

Choosing the filename format allows you to indicate acceptable naming conventions for all files stored in the DOS name space on the server.

Choosing “DOS Filename Format” limits you to using valid DOS filename characters according to the country code and code page.

Limiting the server to valid DOS filename characters prevents workstations using NETX shells (rather than VLMs) from creating files using nonstandard DOS filename characters.

Choosing “NetWare Filename Format” allows you to use NetWare-acceptable characters that may or may not be valid DOS filename characters.

A menu similar to the one below appears:

Figure 3-1
Choose the Desired
Server Language



2. Choose the language in which you want the server installed and press <Enter>.

The “Select the Type of Installation Desired” menu appears.

Choose the Type of Installation

You can choose from four installation options as shown in Figure 3-2 below:

Figure 3-2
Choose the Type of
Installation

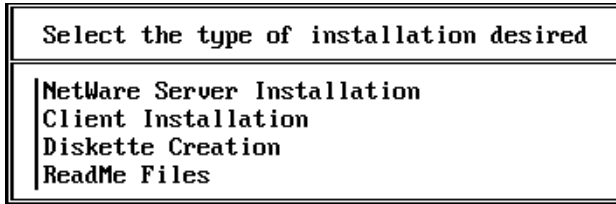

If	Then
You want to install the NetWare server	<p>Choose "NetWare Server Installation."</p> <p>Continue with "Name Your Server and Assign an IPX Network Number" below.</p>
You want to install Clients	<p>Choose "Client Installation."</p> <p>A screen appears allowing you to install the Client 32 Administrative Utility and a number of clients.</p> <p>Choose the option you want to install and follow the screen prompts.</p> <p>Note: You can also install the Client 32 Administrative Utility and any of these clients later under the heading "Perform Other Installation Options (Optional)" on page 131, or after you finish the server installation by running the INSTALL.NLM.</p>

If	Then
You want to create diskettes	<p>Choose "Diskette Creations."</p> <p>A screen appears allowing you to create diskettes for the Client 32 Administrative Utility and a number of clients.</p> <p>Choose the option for which you want to create diskettes and follow the screen prompts.</p> <p>Note: You can also create diskettes for the Client 32 Administrative Utility and any of these clients later under the heading "Perform Other Installation Options (Optional)" on page 131, or after you finish the server installation by running the INSTALL.NLM.</p>
You want to read the ReadMe files	Choose "ReadMe Files."

Name Your Server and Assign an IPX Network Number

Once you've chosen the language in which the server will be installed, the following menu appears:

```

NetWare 4.11
NetWare 4.11 SFT III
Display Information (README) File

```

Procedure



- 1. Choose "NetWare 4.11" and press <Enter>.**

A menu appears displaying additional installation options.
- 2. Choose "Custom Installation of NetWare 4.11" and press <Enter>.**

A screen appears requesting a server name.
- 3. Type the server name in the field provided and press <Enter>.**

For help on rules for naming servers, press <F1>.

A new screen appears displaying a randomly generated IPX internal network number, an ID number that identifies and advertises this server on the network.

4. **Either accept the randomly generated IPX internal network number or enter a new one, and press <Enter>.**

You can't assign an IPX internal network number of "0" or "FFFFFFF."

For more information on the IPX internal network number, see "IPX internal network number" in the *Concepts* manual, which is available online.



For future reference, record your IPX internal network number on the NetWare 4.11 Server Worksheet (Figure 3-42 on page 141).

5. **Continue with "Copy Server Boot Files to the DOS Partition" below.**

Copy Server Boot Files to the DOS Partition

A screen similar to the one below shows the default path and destination directory that the server boot files will be copied to:

Figure 3-3
The Source and Destination Paths

Source path: D:\NW411\INSTALL\ENGLISH
Destination path: C:\NWSERVER

Procedure

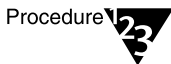

1. **Accept or change the default destination path and copy the files.**

If you want to	Then
Copy the boot files to the default destination directory created for you	Press <Enter>.

If you want to	Then
Copy the boot files to a destination directory of your own choice	Press <F4>, type a directory path and name, press <Enter>, choose "Yes," and press <Enter> again.

2. Continue with "Specify Language and Filename Format Information" below.

Specify Language and Filename Format Information

Once the boot files are copied, the "Language Configuration" screen appears:

Figure 3-4
Language
Configuration
Screen

```

Country Code:      001  (United States)
Code Page:        437  (United States English)
Keyboard Mapping:  None

                Press <Enter> here, to continue

```

For information on any of the settings in this screen, press <F1> or refer to your DOS manual.

Procedure

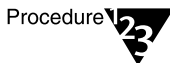

1. Specify the country code, code page, and keyboard mapping.

Use the Up- and Down-arrow keys to maneuver through the screen.

- 1a. (Conditional) If the country code setting is *not* correct, press <Enter> to view options and choose an applicable country code.**

The "Code Page" field is highlighted.

- 1b. (Conditional) If the code page setting is *not* correct, press <Enter> and choose an applicable code page.**

The "Keyboard Mapping" field is highlighted.

1c. **(Conditional) If you do *not* have a standard U.S. English keyboard, press <Enter> and choose an applicable keyboard type.**

2. **Press <Enter> to continue.**

If you have chosen to specify the filename format (DOS or NetWare), the following screen appears:

Figure 3-5
Choose a Filename
Format

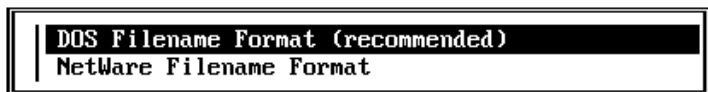

This screen allows you to indicate acceptable naming conventions for all files stored in the DOS name space on the server.

Choosing “DOS Filename Format” limits you to using valid DOS filename characters according to the country code and code page choices in Step 1a and Step 1b, respectively.

Limiting the server to valid DOS filename characters prevents workstations using NETX shells (rather than VLMS) from creating files using nonstandard DOS filename characters.

Choosing “NetWare Filename Format” allows you to use NetWare-acceptable characters that may or may not be valid DOS filename characters.

3. **(Conditional) Choose the filename format you need and press <Enter>.**

4. **Specify startup SET commands by choosing “Yes” or “No.”**

Choosing “Yes” brings up an edit box for entering the startup commands.

If you have disk, CD-ROM, or other devices that use ASPI, you should add the following line to your STARTUP.NCF file:

```
SET RESERVED BUFFERS BELOW 16MB = 200
```

To see if your device uses ASPI, refer to the device documentation.

5. **(Conditional) If you specified any startup SET commands in Step 4, save them by pressing <F10>.**

6. (Optional) Add SERVER.EXE to your AUTOEXEC.BAT file.

Install now executes SERVER.EXE and INSTALL.NLM.

If you choose	Then
Yes	SERVER.EXE runs automatically when you reboot the computer.
No	The DOS prompt appears whenever you reboot and you must type SERVER in the directory containing SERVER.EXE.

7. Unless you have multiple processors, continue with “Load the Device Drivers” on page 70. If you have multiple processors, continue with “Install NetWare SMP (Conditional)” below.

Install NetWare SMP (Conditional)

Symmetric MultiProcessing (SMP) allows multiprocessing-enabled NetWare Loadable Modules (NLMs) to run across multiple processors and take advantage of the increased processing power they provide. For more information about SMP, please see *Supervising the Network*.

When SMP is installed, three lines are added to your STARTUP.NCF file:

```
Load [name of your Platform Support Module (PSM)] (All PSM's will have a .PSM extension.)
```

```
Load SMP.NLM
```

```
Load MPDRIVER.NLM ALL
```

If you choose to uninstall SMP, you can do so from a DOS prompt by editing the STARTUP.NCF file and manually removing these lines. There is also an uninstall option in INSTALL.NLM which will remove these lines for you.

If you have symmetrical multiprocessors, and you have chosen to run Install with autodetection enabled, Install detects the multiple processors and presents the message below:

"Do you want to install Symmetrical Multi-processing NetWare (SMP)?"

Procedure

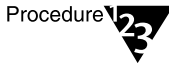

1. Choose "Yes" or "No."

If you choose "No," you can install SMP another time through INSTALL.NLM.

If you choose "Yes," Install adds the following SET command to your AUTOEXEC.NCF file:

```
Set upgrade low priority threads = ON
```

If you choose to uninstall SMP, this SET command is removed automatically from your AUTOEXEC.NCF file.

Also, if you choose "Yes," Install attempts to find the Platform Support Module (PSM) files to load. If found, these drivers are displayed in a list as shown Figure 3-6.

2. Choose a PSM driver appropriate for your computer.

The drivers found are displayed in a list as shown in Figure 3-6 below. If the list is empty or if the driver you need is not displayed, Install was unable to detect any PSM drivers. Press <Insert> to install the appropriate drivers from another location, such as from a floppy diskette or from another server.

Figure 3-6

Choose Your PSM Driver

COMPAQ.PSM	Platform Support Module for COMPAQ ProLiant
CPQPSM.PSM	Compaq SMP Platform Specific Module
CPQSMP.PSM	Compaq SMP Platform Specific Module
MPS14.PSM	Platform Support Module for INTEL MPS

If your PSM drivers are found on the CD, SMP is automatically installed and you can continue with "Load the Device Drivers" below.

If you specified another location from which to install your PSM drivers, you need to select the appropriate driver, and respond “Yes” when Install asks whether to save the existing file.

3. Continue with “Load the Device Drivers” below.

Load the Device Drivers

Install automatically detects the hardware devices on your machine, including hard disks, CD-ROM drives, LAN cards, etc. It then scans for and selects applicable drivers for the hardware.

If	Then
Drivers are selected automatically	Proceed with “Load the LAN Drivers” on page 73. After the LAN drivers are loaded, a summary of selected drivers appears in Figure 3-9 on page 76. You can then continue with the drivers shown or you can modify the choices that have been made for you.
Drivers are not selected automatically, or if Install found more than one driver for your hardware or was unable to match a hardware device with a driver	Continue without choosing a driver or choose manually which driver to load by following the process below.

Your drivers may not be selected for the following reasons:

- ◆ Your machine does not have an advanced bus (EISA, PCI, PNPISA, MCA).
- ◆ Your hardware is non-Plug and Play ISA.
- ◆ The drivers you need are not included with this release, or they do not contain information needed by the autodetection process.

If you need to choose your drivers manually, the driver selection screen shown in Figure 3-7 below appears:

Figure 3-7
Choose Your Disk Driver

Select a driver:	
ASPICD.DSK	Adaptec CD-ROM (ASPI Compatible) Driver
ASPITRAM.DSK	Adaptec NetWare ASPI Transport Layer
IDEATA.HAM	Novell IDE (ATA/ATAPI Compatible) Host Adapter Module (HAM)
SCSI154X.HAM	Adaptec AHA-1540/42 Reference HAM Module
TAPEDAI.DSK	NetWare 386 Tape Device Driver



Warning If you are installing from CD-ROM and the CD-ROM drive is connected to a SCSI adapter shared by another internal or external device (hard disk, tape device, etc.), you may experience a keyboard lockup problem while loading drivers or copying files. If this occurs, contact your SCSI adapter manufacturer for updated drivers.

Similar to a disk driver, a CD-ROM driver enables communication between the CD-ROM and the server's CPU. In some cases, you must choose a CD-ROM driver as well as a disk driver.

Disk drivers have a description that appears as you highlight the driver. A list of standard Novell® drivers is shown in Table 3-1.

Table 3-1
Standard Novell Disk Drivers

Computer architecture	Controller	Disk driver you must load
Industry Standard Architecture (ISA)	AT	ISADISK
	IDE (ATA)	IDE
Microchannel	ESDI	PS2ESDI
	IBM SCSI	PS2SCSI
Extended Industry Standard Architecture (EISA)	AT class	ISADISK
	IDE (ATA)	IDE
	EISA vendor proprietary	See vendor

For example, if you have an ISA computer, load the IDE disk driver.

Besides Novell drivers, additional third-party drivers are included with NetWare 4.11.



If you experience problems with third-party drivers, contact the manufacturer listed in the driver description that appears as you highlight the driver.

Procedure



1. Choose your disk driver.

The selected disk driver is then copied to the server boot directory before it is loaded.

If more than one hard disk of the same type is installed in your computer, and if the disks are both connected to the same disk controller, load only one disk driver for that controller.

If the disks are connected to different controllers, load the driver multiple times or load additional disk drivers.

If	Then
The driver is listed	Choose the appropriate disk driver and continue with Step 2.
The driver is not listed	Press <Ins> and follow the prompts. Then continue with "Load the LAN Drivers" below.

2. Verify that the displayed parameter settings are correct.

A prompt appears asking you either to choose and modify driver parameters or to save parameters and continue. If you save the displayed parameters and continue, another prompt appears asking if you want to load any additional drivers.

If you want to	Then
Load additional disk drivers, or load separate CD-ROM drivers	Choose "Yes" and press <Enter>. Then repeat Step 1 and Step 2.
Proceed without loading additional disk drivers	Continue with "Load the LAN Drivers" below.

Load the LAN Drivers

Install automatically detects the hardware devices on your machine, including hard disks, CD-ROM drives, LAN cards, etc. It then scans for and selects applicable drivers for the hardware.

If	Then
Drivers are selected automatically	Go to the summary of selected drivers shown in Figure 3-9 on page 76. You can then continue with the drivers shown or you can modify the choices that have been made for you.
Drivers are not selected automatically, or if Install found more than one driver for your hardware or was unable to match a hardware device with a driver	Continue without choosing a driver or choose manually which driver to load by following the process below.

Your drivers might not be selected for the following reasons:

- ◆ Your machine does not have an advanced bus (EISA, PCI, PNPISA, MCA).
- ◆ Your hardware is non-Plug and Play ISA.
- ◆ The drivers you need are not included with this release, or they do not contain information needed by the autodetection process.

A LAN driver must be loaded to establish a network connection (if the server is physically connected to the network cabling). Your choice of LAN drivers depends on the cabling system and the network board you are using.

Most NetWare 4.11 LAN drivers have an individual description that appears on the screen when you choose the driver. Refer to Table 3-2 on page 74 and to the on-screen descriptions to determine which LAN driver to load.



If you experience problems with third-party drivers, contact the manufacturer listed in the driver description that appears as you highlight the driver.

**Table 3-2
Novell LAN Drivers**

Cabling system	Network board	LAN driver you must load
ARCnet*	RX-Net RX-Net II RX-Net/2	TRXNET.LAN
Ethernet	NE/2 NE/2T NE/2-32 NE1000 - ASSY 950-054401 NE1000 - ASSY 810-160-001 NE2000 - ASSY 810-149 NE2000T - ASSY 810-000220 NE2100 - ASSY 810-000209 NE1500T - ASSY 810-000214 (twisted-pair version of NE2100) NE3200	NE2.LAN NE2_32.LAN NE1000.LAN NE2000.LAN NE2100.LAN NE1500T.LAN NE3200.LAN
	NE32HUB	NE32HUB.LAN
Token Ring	NTR2000	NTR2000.LAN

For example, if you have a Novell NE2100™ network board installed in your computer, you must load the NE2100.LAN driver.

Procedure

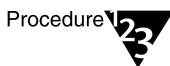

- 1. Choose your LAN driver from the LAN driver screen shown in Figure 3-8 below.**

If the LAN drivers are not selected and loaded automatically, the screen in Figure 3-8 appears. The selected LAN driver is then copied and stored temporarily in the C: drive before it is loaded.

Figure 3-8
Choose Your LAN Drivers

▲	NE2000.LAN	Novell Ethernet NE2000
	NE2100.LAN	Ansel M2100 All-In-One-Networking
	NE2100.LAN	EXOS 105
	NE2100.LAN	Novell Ethernet NE2100
	NE2100.LAN	Wearnes 2110T or Wearnes 2107C
▼	NE2_32.LAN	Novell Ethernet NE/2-32

If	Then
The driver is listed	Choose the appropriate LAN driver and continue with Step 2.
The driver is not listed	Press <Ins> and follow the prompts. Then continue with Step 2.

2. Verify that the displayed LAN driver parameter settings are correct.

A prompt appears asking you either to select and modify driver parameters or to save parameters and continue. You can modify the driver frame types by pressing <F3>.

If you continue and save the displayed parameters, another prompt appears asking if you want to load any additional drivers.

If you want to	Then
Load additional LAN drivers	Choose "Yes" and press <Enter>. Then repeat Steps 1 and 2.
Proceed without loading additional LAN drivers	Continue with Step 3.

3. Verify selected Disk/LAN drivers.

If your drivers are automatically selected, the screen in Figure 3-9 below appears displaying the selected disk and LAN drivers. A prompt asks you to select additional Disk/LAN drivers or modify selected Disk/LAN drivers.

Verify that there is at least one disk driver per controller and one LAN driver per LAN adapter. Take into account controllers and adapters that are integrated into the computer's CPU and those on the computer's expansion cards.

Figure 3-9
Chosen Drivers Are Displayed Prior to Being Loaded

	Driver Names
Disk and CD-ROM Drivers:	>IDEATA, IDEHD
Network (LAN) Drivers:	>NE2000

Driver Actions
Select additional or modify selected Disk/LAN drivers Continue installation

If you want to	Then
Load additional drivers or modify the settings of any previously selected drivers	Choose "Select Additional or Modify Selected Disk/LAN Drivers," and follow the screen prompts. Once all appropriate network drivers have been chosen, continue with Step 4 below.
Proceed without loading additional drivers	Continue with Step 4.

4. Verify selected LAN driver protocols.

The screen in Figure 3-10 appears displaying the selected LAN drivers and their protocols, and a prompt asks you to view or modify the selected protocols settings.

Figure 3-10
Selected LAN Drivers and their Protocols Are Displayed Prior to Being Bound

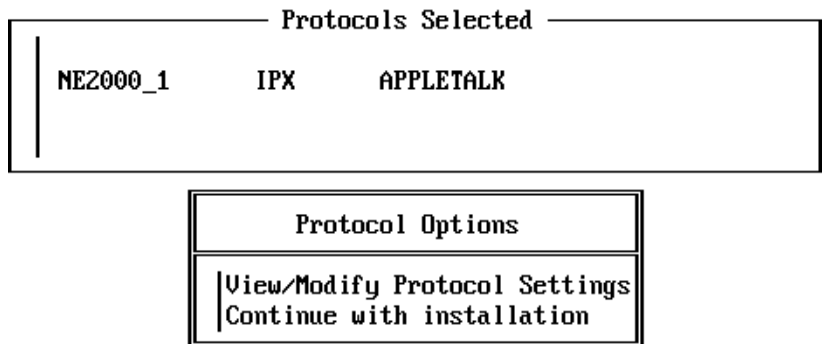

If you want to	Then
View or modify LAN driver protocol settings	Choose "View/Modify Protocol Settings," and continue with Conditional Steps 5 through 7. Once all protocol settings have been chosen, continue the installation process.
Proceed without viewing or modifying protocol settings	Continue installation in Step 8.

5. (Conditional) Choose "View/Modify Protocol Settings."

After you press <Enter> to view or modify protocol settings, you are asked to choose the LAN driver for which you will modify the protocol settings. Choose your LAN driver, and the screen in Figure 3-11 appears, showing the previously selected protocol settings for that LAN driver.

Figure 3-11
Protocol Settings

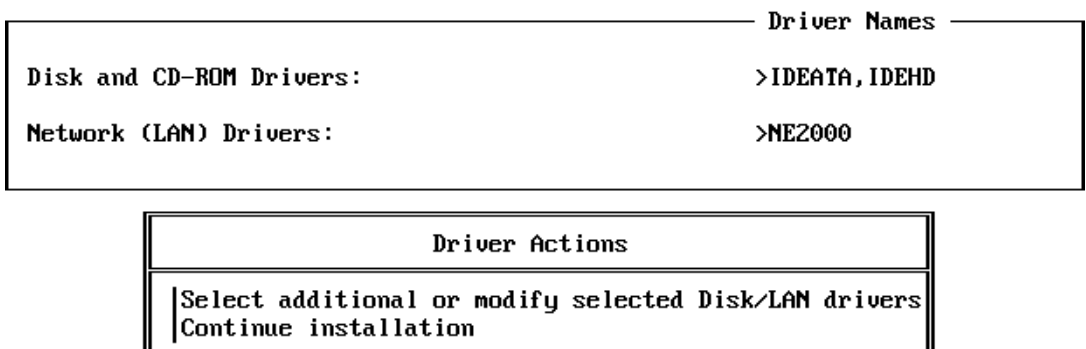

6. **(Conditional) Press <Enter> to select or deselect protocols from the options shown in Figure 3-11.**
7. **(Conditional) If you chose TCP/IP, enter the IP address and IP mask numbers and press <F10>.**



If you are installing NetWare/IP, make sure that your IP address and netmask are correct. Typically, you enter the netmask in a hexadecimal format.

For more information on NetWare/IP, please see “Install NetWare/IP (Conditional)” on page 98.



Protocols selected here are nonrouting. If you want to configure routing protocols, do so through the “Configure Network Protocols” option, which is available after the server is installed. See “Configure Network Protocols” on page 134.

8. **Choose “Continue Installation.”**

At this time, NetWare 4.11 loads the drivers that have been chosen. In the case of LAN drivers, all frame types will be loaded and applicable frames bound to IPX.

Mount the CD-ROM as a NetWare Volume (Conditional)

If you are installing from CD-ROM, the screen in Figure 3-12 appears if the CD-ROM device is not available to NetWare.

Procedure

Procedure



1. (Conditional) If you are installing from CD-ROM and the menu in Figure 3-12 appears, choose one of the menu options.

Figure 3-12
You Can Try to
Mount the CD-ROM
as a NetWare
Volume

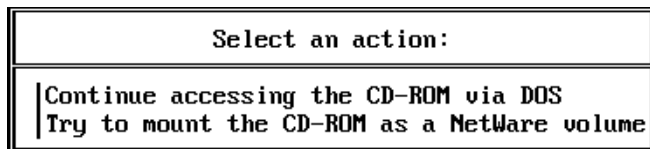

If a disk or CD-ROM driver you selected earlier conflicts with the DOS CD-ROM driver, your keyboard may lock up during installation. To avoid this, you can attempt to mount the CD-ROM as a NetWare volume. In doing so, you may be prompted to install new disk or CD-ROM drivers.

2. Continue with “Create NetWare Disk Partitions” below.

Create NetWare Disk Partitions

The following screen appears, ready for you to create NetWare disk partitions.



Every NetWare 4.11 server needs a disk partition for NetWare files and shared data. You can have only one NetWare 4.11 disk partition per disk, but you can have up to eight volume segments on the NetWare disk partition.

If your server’s boot hard disk has a DOS partition, use the rest of the disk space as a NetWare disk partition.

Figure 3-13
Disk Partitions and
Volumes on an
Internal Hard Disk

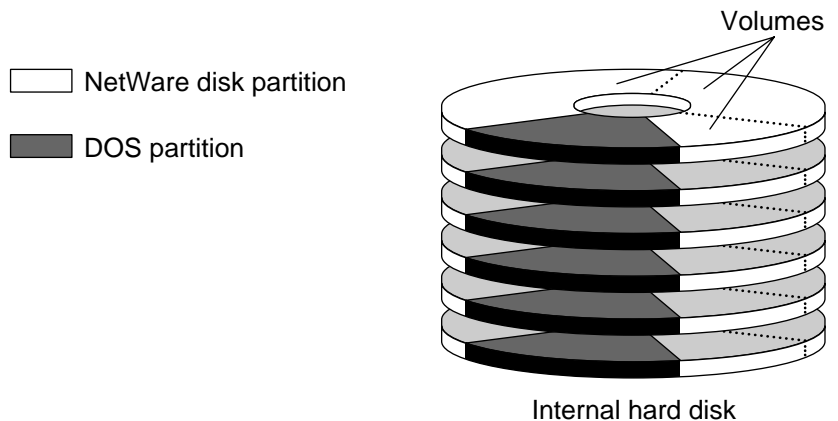

The custom installation option offers two ways of creating NetWare disk partitions, automatically and manually.

If	Choose
You want NetWare to create NetWare disk partitions in the available disk space without the option of mirroring or duplexing the disks	Automatically (see "Create NetWare Disk Partitions Automatically" on page 81).
<ul style="list-style-type: none"> ◆ You want to specify the size of the NetWare partition ◆ You need room for other operating systems on the disk ◆ You want to mirror or duplex disk partitions (this is possible only if you have more than one disk and have more than one disk controller) ◆ You want to change the size of the Hot Fix Redirection Area ◆ You want to selectively delete current disk partitions 	Manually (see "Create NetWare Disk Partitions Manually" on page 81).

Create NetWare Disk Partitions Automatically

This option automatically creates a NetWare disk partition in the available disk space on each disk.

- ◆ On the *boot* disk, a NetWare partition is created on the disk space not occupied by the DOS partition.
- ◆ On *other* disks, all disk space is allocated to the NetWare partition.

Procedure

Procedure



1. From the “Create NetWare Disk Partitions” menu, choose “Automatically.”
2. Go to “Manage NetWare Volumes” on page 86.

Create NetWare Disk Partitions Manually

This option allows you to create manually a NetWare disk partition in the available disk space on each disk. If you indicate you want to delete existing partitions, any existing NetWare partitions (but not DOS partitions) will be destroyed.

Procedure

Procedure



1. From the “Create NetWare Disk Partitions” menu, choose “Manually” and press <Enter>.
2. From the “Disk Partition Options” menu, choose “Create NetWare Disk Partition” and press <Enter>.

NetWare allows only one NetWare partition per disk; however, multiple disks can be used to create a single partition.

3. (Conditional) If you have more than one disk, from the “Available Disk Drives” menu, choose the disk you need to partition and press <Enter>.
4. In the “Disk Partition Information” screen shown in Figure 3-14, specify the size of the NetWare partition (in megabytes) and press <Enter>.

Figure 3-14
The “Disk Partition
Information” Screen

Disk Partition Information		
Partition Type:	NetWare partition	
Partition Size:	456 cylinder,	69.5 MB
Hot Fix Information:		
Data Area:	17428 blocks,	68.1 MB
Redirection Area:	356 Blocks,	2.0 %

The Hot Fix information is adjusted automatically. NetWare adjusts the percentage for Hot Fix according to the disk capacity.

For more information on Hot Fix, see “Data protection” or “Hot Fix” in *Concepts*.



Many disk drive manufacturers advertise drive sizes in millions of bytes (for megabytes) or billions of bytes (for gigabytes). However, NetWare reports the drive size in true megabytes (1,048,576 bytes).

If the drive size for a NetWare partition appears smaller than expected, this is most likely the reason.

In addition, NetWare disk space does not show the disk space allocated for Hot Fix (the Hot Fix Redirection Area).

5. **(Conditional) If necessary, change the size of either the data area (in megabytes) or the Hot Fix Redirection Area (in percentage of disk partition size) and press <Enter>.**

If you change one of the fields, Install calculates the space remaining for the other field.

6. **To save and continue, press <Esc>.**
7. **When prompted to “Create NetWare Partition?” choose “Yes” and press <Enter>.**
8. **(Optional) If you want to create NetWare partitions on multiple drives, press <Esc> and then repeat Step 3 through Step 7.**
9. **If you want to mirror or duplex disks, continue with “Mirror or Duplex NetWare Disk Partitions (Optional)” on page 83. If you don’t want to mirror disk partitions, choose “Continue with Installation,” and go to “Manage NetWare Volumes” on page 86.**

Mirror or Duplex NetWare Disk Partitions (Optional)

NetWare 4.11 protects data from hard disk failure by letting you duplicate (mirror) one hard disk's data on one or more other hard disks. Then, if one of the disks fails and cannot be accessed by the server, you can continue to work from the functional disk.

You can safeguard your data in either of two ways:

- ◆ **Mirroring.** The operating system stores duplicate data on two disks using the *same* controller.
- ◆ **Duplexing.** The operating system stores duplicate data on two disks using *different* controllers.

Duplexing offers better protection because losing two disk controllers simultaneously is even less likely than losing two hard disks.



Mirroring and duplexing options are available only on systems having more than one hard disk.

Mirroring and duplexing are illustrated in the following figure:

Figure 3-15
Mirroring and Duplexing

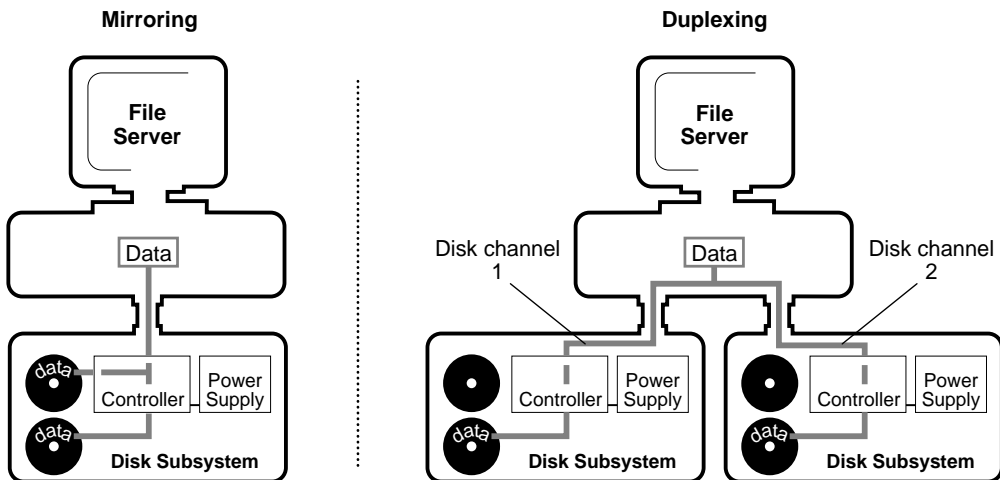

Consider the following as you mirror or duplex your hard disks:

- ◆ The installation processes for mirroring and duplexing are the same.
- ◆ Partition sizes of the mirrored or duplexed hard disks should be similar. Otherwise, any remaining space on the larger partition is wasted, since NetWare makes adjustments so that the mirrored partitions are exactly the same size.
- ◆ Two mirrored partitions are usually sufficient, but you can mirror as many as eight partitions.
- ◆ Which hard disks you mirror depends on how you decide to set up volumes on the server. See “Suggestions for Creating Volumes” on page 88.

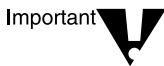

Before mirroring or duplexing a hard disk, back up your data.

Procedure



1. From the “Disk Partition and Mirroring Options” menu, choose “Mirror and Unmirror Disk Partition Sets” and press <Enter>.

The “Disk Partition Mirroring Status” screen appears and displays one of the following conditions for each disk partition:

Status	Explanation
Not Mirrored	The disk partition is not currently mirrored to another partition.
Mirrored	The disk partition is currently mirrored to another disk partition.
Out Of Sync	The disk partition was previously mirrored to another disk partition, but mirroring isn't currently active. The disk partition can't be accessed until mirroring is restored. Press <F3> to restore mirroring.
Remirroring	The partitions are being remirrored.

All disk partitions initially appear as “Not Mirrored.”

2. **Choose one of the disk devices (disk partitions) you want to mirror or duplex and press <Enter>.**

The partition you choose becomes the primary partition of the mirrored set. (See “Device numbering” in *Concepts* for an explanation of how logical partitions relate to the installed hard disks.)

A list of disk partitions on the selected disk device appears.

3. **Press <Ins> to access the “Available Disk Partitions” list.**
4. **Choose the disk partition you want to mirror to the device (disk partition) you chose in Step 3, and press <Enter>.**

If this disk partition is smaller or larger than the disk partition it will be mirrored to, the following message appears:

```
The selected NetWare disk partition is larger/  
smaller than the original NetWare partition.  
These partitions must be the same size in order  
to be mirrored. Press <Enter> to continue.
```

- 4a. **(Conditional) Press <Enter> to continue.**

The “Change the Selected NetWare Disk Partition’s Size?” prompt then appears.

- 4b. **(Conditional) Choose “Yes” to make the partitions the same size and press <Enter>.**

NetWare automatically adjusts the size of the larger disk partition to match that of the smaller partition.

The “Mirrored NetWare Disk Partitions” menu appears.

5. **Press <F10> to return to the “Disk Partition Mirroring Status” screen.**

The “Disk Partition Mirroring Status” screen displays those disk partitions that are mirrored to each other.

For example, if you mirrored disk (device) 0 to disk (device) 1, the “Disk Partition Mirroring Status” screen would appear similar to the one in Figure 3-16.

Figure 3-16
The “Disk Partition Mirroring Status” Screen

Disk Partition Mirroring Status	
Not Mirrored:	Device 2
Mirrored:	Device 0,1

6. Press <F10> to return to the “Disk Partition and Mirroring Options” menu.
7. Choose “Continue with Installation” and press <Enter>.
8. Continue with “Manage NetWare Volumes” below.

Manage NetWare Volumes

The “Manage NetWare Volumes” screen shown in Figure 3-17 lists the volumes Install creates for you unless you change the defaults. The number of volumes listed depends on the hard disks.

Figure 3-17
“Manage NetWare Volumes” Screen

Volume Name	Size (MB)
SYS	160 (new system volume)
VOL1	260 (new volume)

For servers with single hard disks, Install assigns all disk space (except for a DOS partition) to a single volume SYS:. In the “Volume Disk Segment List” (see Figure 3-18 on page 89), volume SYS: is displayed as “Device 0.”

For servers using several hard disks, Install creates one volume for each hard disk. In the “Volume Disk Segment List,” additional volumes appear as “Device 1,” “Device 2,” etc.

You can perform the following management operations on volumes before you save and mount the volume:

- ◆ Modify volume segment size
- ◆ Modify volume name

- ◆ Modify volume block size
- ◆ Enable/Disable file compression
- ◆ Enable/Disable block suballocation
- ◆ Enable/Disable data migration

Modify Volume Parameters

You can rename any of the volumes, except for volume SYS:. Having a volume SYS: is mandatory since it stores system information needed by NetWare.

You can also change the number and sizes of the volumes by deleting one or more of them and reallocating the resulting free space.

We recommend allocating at least 90 MB of disk space to volume SYS:. However, you may need to allocate additional space in the following situations:

- ◆ You plan to install several “optional” files (NetWare OS/2 utilities, for example). If not enough volume space is available when file copying begins (see “Copy NetWare Files” on page 103), you are prompted to resize the volume before continuing with the file copy.
- ◆ You plan to print large files. NetWare needs additional storage space to spool these files.
- ◆ You plan to install a single language set of NetWare 4.11 online documentation and a single DynaText* viewer. (This requires approximately 60 MB of free space on volume SYS:.)

NDS and Volume SYS:

After you’ve installed Novell Directory Services (see “Installing Novell Directory Services” on page 105), each server’s volume SYS: appears as *servername_SYS* in the Directory tree. This logical name is the name of the Volume object in the Directory tree.

For example, if you named the server TECHSERVER, its volume SYS: would appear as Volume object TECHSERVER_SYS in the Directory

tree. The name of the physical volume, as seen from the server, still remains SYS:.

Suggestions for Creating Volumes



- ◆ Reserve volume SYS: for the NetWare files and create one or more additional volumes for applications and data.

Since NDS objects are stored on volume SYS:, make sure you leave adequate space for additional NDS objects if you anticipate growth of your network.

- ◆ If fault tolerance is more important than performance, create one volume per disk.
- ◆ If performance is more important than fault tolerance, span one NetWare volume over many hard disks with one segment of the volume on each hard disk.



If any disk on a spanned volume fails, the whole volume is lost. Make sure you back up spanned volumes regularly so you can restore the entire volume (all its segments) from backup once the disk(s) is repaired or replaced.

- ◆ If both performance and fault tolerance are important, you can both span and duplex, but we recommend that you duplex *every* hard disk partition of the spanned volume. See “Mirror or Duplex NetWare Disk Partitions (Optional)” on page 83.
- ◆ For maximum fault tolerant protection, we recommend purchasing NetWare SFT III.
- ◆ If your network includes workstations using an operating system that allows long filenames (such as Macintosh*), it is a good idea to create a separate volume for each operating system.

Long filenames (filenames longer than those allowed by DOS) take up disk space that is not required for DOS files. Also, you can isolate network problems more easily.

For example, if your network includes both DOS and Macintosh file types, you may want to create two volumes for data, DOSVOL: and MACVOL:. This way, you add name space only to those volumes whose files need it.

- ◆ If you are using the NetWare auditing feature and one volume will contain data to be reviewed by two or more auditors, you can (for security reasons) create a separate volume for each auditor.

For example, assume you plan to audit a volume that contains accounting and sales data, but plan to have two auditors do the work.

In this situation, if you are concerned about these auditors accessing each other's audit reports, you should create two separate volumes, one for accounting data and one for sales data.

Auditing rights for the file system are assigned per volume (after server installation) using the AUDITCON utility.

For more information, refer to *Auditing the Network*.

Modify the Size of a Volume Segment (Optional)

If you do not want to modify the size of a volume segment, you can go to any of the optional procedures in this section, or you can continue the installation by going to "Save and Mount Volumes" on page 98.

You can modify the size of an existing volume (a volume that's been saved to disk) only by deleting and re-creating it.

To modify a volume segment size (for example, to decrease the size of volume SYS: in order to create another volume), follow these steps.

Procedure

Procedure



1. In the "Manage NetWare Volumes" screen, press <Ins> or <F3>.

The "Volume Disk Segment List" screen appears:

Figure 3-18
The "Volume Disk Segment List" Screen

Volume Disk Segment List				
Device No.	Segment No.	Size (MB)	Volume Assignment	Status
0	0	477	SYS	ES
1, 2	0	146	GREEN	E M
4, 3	0	146	HOOK	E M

2. **Choose the device number whose volume size you want to modify and press <Enter>.**

The “Disk segment parameters” list appears.

3. **In the “Disk Segment Size” field, type the new volume size in megabytes (or fraction thereof) and press <Enter>.**
4. **Press <Esc> to return to the “Volume Disk Segment List” screen.**

If you decrease the size of the volume, the remaining space appears as “free space.” You can assign it to another volume by highlighting the “free space” listing and pressing <Enter>.

5. **Modify other volume parameters, or press <Esc> and continue with “Save and Mount Volumes” on page 98.**

Modify Volume Name (Optional)

If you do not want to modify the volume name, you can go to any of the other optional procedures in this section, or you can continue the installation by going to “Save and Mount Volumes” on page 98.

Volume SYS: can't be renamed.

Procedure

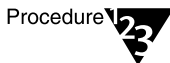

1. **In the “Manage NetWare Volumes” screen, choose the volume whose name you want to change and press <Enter>.**

The “Volume Information” screen appears:

Figure 3-19
The “Volume
Information” Screen

Volume Information	
Volume Name:	EAGLE
Volume Block Size:	16 KB Blocks
Status:	Not Mounted
File Compression:	On
Block Suballocation:	On
Data Migration:	Off

2. Choose the “Name” field in the “Volume Information” screen and press <Enter>.

3. Type in a new volume name and press <Enter>.

Press <F1> for naming rules.

4. Either modify other volume parameters or press <Esc> to return to the list of volumes.

Unlike some parameter settings, which can be modified later, the following parameter settings can be modified *only* before volumes are saved and mounted:

- ◆ Enable/Disable File Compression (see “Enable/Disable File Compression (Optional)” on page 93)
 - ◆ Enable/Disable Block Suballocation (see “Enable/Disable Block Suballocation (Optional)” on page 95)
5. Modify other volume parameters, or press <Esc> and continue with “Save and Mount Volumes” on page 98.

Modify Volume Block Size (Optional)

If you do not want to modify the volume block size, you can go to any of the other optional procedures in this section, or you can continue the installation by going to “Save and Mount Volumes” on page 98.

Install sets the following defaults for block size. These block sizes minimize RAM and disk space requirements for the volume sizes indicated.

Volume size	Block size
0 to 31 MB	4 KB or 8 KB
32 to 149 MB	16 KB
150 to 499 MB	32 KB
500+ MB	64 KB



We recommend accepting these defaults, but there may be advantages to adjusting block sizes.

Small block sizes require more server memory to track the File Allocation Table (FAT) and Directory Entry Table (DET). Also, larger block sizes are best for large database records. Larger block sizes are preferred if block suballocation is enabled (see “Enable/Disable Block Suballocation (Optional)” on page 95).

Since you cannot change the block size once a volume is saved to disk, if you plan to eventually expand volumes, choose the block size according to the final predicted volume size.

Procedure



1. In the “Manage NetWare Volumes” screen, choose the volume whose block size you want to change, and press <Enter>.

The “Volume Information” screen shown in Figure 3-20 appears:

Figure 3-20
The “Volume
Information” Screen

Volume Information	
Volume Name:	EAGLE
Volume Block Size:	16 KB Blocks
Status:	Not Mounted
File Compression:	On
Block Suballocation:	On
Data Migration:	Off

2. Use the arrow keys to highlight the “Volume Block Size” field and press <Enter>.
3. Choose a new block size and press <Enter>.
Large block sizes (32 KB or 64 KB) can cause some DOS utilities to calculate the amount of free hard disk space incorrectly.
4. Modify other volume parameters, or press <Esc> and continue with “Save and Mount Volumes” on page 98.

Enable/Disable File Compression (Optional)



Once file compression for a volume is enabled and volume information is saved to disk, you can't change the compression status of the volume. You must delete the volume and re-create it to change the file compression status.

If you do not want to enable or disable file compression, you can go to any of the other optional procedures in this section, or you can continue the installation by going to “Save and Mount Volumes” on page 98.

If file compression is enabled, files in a volume that are not accessed for a specified amount of time are converted to a compressed state, thus saving disk space. A compressed file becomes uncompressed when it is accessed.

The default setting for file compression is “On.”

File compression is enabled at the volume level. To set individual files in that volume either with or without compression, you must use the FLAG utility or the NetWare Administrator utility (after installation).



To maximize disk space, you should enable both file compression and block suballocation (see “Enable/Disable Block Suballocation (Optional)” on page 95).

For more information, see “File Compression” in *Concepts*, or “Using File Compression” in Chapter 7 of *Supervising the Network*.

Procedure



1. **At the “Manage NetWare Volumes” screen, choose the volume you want to change the file compression status for and press <Enter>.**

The “Volume Information” screen shown in Figure 3-21 appears:

Figure 3-21
The “Volume Information” Screen

Volume Information	
Volume Name:	EAGLE
Volume Block Size:	16 KB Blocks
Status:	Not Mounted
File Compression:	On
Block Suballocation:	On
Data Migration:	Off

2. **Use the arrow keys to highlight the “File Compression” field and press <Enter>.**

The “Select a Volume Compression Setting” screen appears.

3. **Toggle between “On” and “Off” by pressing <Enter>.**
4. **Modify other volume parameters, or press <Esc> and continue with “Save and Mount Volumes” on page 98.**

Enable/Disable Block Suballocation (Optional)

If you do not want to enable or disable block suballocation, you can go to any of the other optional procedures in this section, or you can continue the installation by going to “Save and Mount Volumes” on page 98.

Block suballocation allows the last part of several files to share one disk block, saving disk space.

Block suballocation divides any partially used disk block into 512-byte suballocation blocks. These suballocation blocks are used to share the remainder of the block with “leftover” fragments of other files.

For example, if block suballocation is not enabled, storing a 5KB file takes two 4KB blocks (on a volume with a 4KB block size); consequently, 3 KB of disk space is wasted.

With block suballocation enabled, the same 5KB file takes up only 5 KB of disk space: one 4KB block and two 512-byte suballocation blocks of another 4KB block. Subsequent files in need of suballocation blocks take them from this block as well, until the 4KB block is used up.

The default setting for block suballocation is “On.”



Hint

To maximize disk space, you should enable *both* file compression and block suballocation.

If you are considering using High Capacity Storage System (HCSS) now or in the future, we recommend turning block suballocation and file compression off.

For more information, see “Block suballocation” in *Concepts*.

Procedure

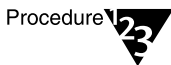

Procedure

1. In the “Manage NetWare Volumes” screen, choose the volume you want to change the block suballocation status for and press <Enter>.

The “Volume Information” screen shown in Figure 3-22 appears:

Figure 3-22
The “Volume
Information” Screen

Volume Information	
Volume Name:	EAGLE
Volume Block Size:	16 KB Blocks
Status:	Not Mounted
File Compression:	On
Block Suballocation:	On
Data Migration:	Off

2. Use the arrow keys to highlight the “Block Suballocation” field and press <Enter>.

The “Select a Volume Compression Setting” screen appears.

3. Toggle between “On” and “Off” by pressing <Enter>.
4. Modify other volume parameters, or press <Esc> and go to “Save and Mount Volumes” on page 98.

Disable/Enable Data Migration (Optional)

If you do not want to enable or disable data migration, you can go to any of the other optional procedures in this section, or you can continue the installation by going to “Save and Mount Volumes” on page 98.

Enabling data migration lets you migrate (move) data to an external storage device (disk, tape, optical disk), while the NetWare operating system still perceives the data as residing on the volume.

This frees up valuable hard disk space for frequently used files while still allowing access, though somewhat slower, to infrequently used files.

For example, a law firm might store case reports on a 500MB volume. They don’t want to archive these files, because they might need any of them at any time. Any single case, however, has only a small chance of being used.

Enabling data migration allows this firm to call up to 256 GB of case data from their 500MB hard disk when using Novell's High Capacity Storage System (HCSS). All cases are migrated and take only a few extra seconds to call up.

The default setting for data migration is "Off."

If you are planning to use an external storage system, this parameter must be set to "On."



If you are planning on moving files to an optical storage system (such as HCSS), set file compression and block suballocation to "Off" to allow HCSS to optimize disk storage.

For more information, see "Data migration" or "High Capacity Storage System" in *Concepts* and Chapter 6, "Migrating Data Using the High Capacity Storage System," in *Supervising the Network*.

Procedure

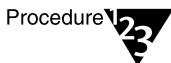

1. In the "Manage NetWare Volumes" screen, choose the volume you want to change the data migration status for and press <Enter>.

The "Volume Information" screen shown in Figure 3-23 appears:

Figure 3-23
The "Volume Information" Screen

Volume Information	
Volume Name:	EAGLE
Volume Block Size:	16 KB Blocks
Status:	Not Mounted
File Compression:	On
Block Suballocation:	On
Data Migration:	Off

2. Use the arrow keys to highlight the "Data Migration" field and press <Enter>.

The "Select a Volume Compression Setting" screen appears.

3. Toggle between “On” and “Off” by pressing <Enter>.
4. Modify other volume parameters, or continue with “Save and Mount Volumes” below.

Save and Mount Volumes

Prior to saving and mounting volumes, you should have made any desired modifications to the NetWare volumes settings.

Once a volume is saved and mounted, you cannot make modifications to the volume settings, listed under “Manage NetWare Volumes” on page 86, without deleting the volumes and re-creating them.

The “Manage NetWare Volumes” screen shown in Figure 3-24 should be present on your screen:

Figure 3-24
Manage NetWare
Volumes Screen

Volume Name	Size (MB)
SYS	160 (new system volume)
VOL1	260 (new volume)

Procedure

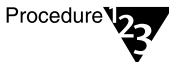

1. While in the list of volumes, press <F10> to save all volume information.

A confirmation screen appears.

2. Choose “Yes” to save the volume changes.

After you have saved volume information to disk, Install mounts all volumes to make them accessible to network users.

Install NetWare/IP (Conditional)

If you chose to install and configure the TCP/IP transport protocol during the procedure in “Load the LAN Drivers” on page 73, Install now asks whether you want to install the NetWare/IP™ software.

Installing NetWare/IP requires you to complete the following steps:

Procedure



1. **When prompted, choose “Yes” to install the NetWare/IP software.**

Before responding to this prompt, carefully consider the information in “When to Install NetWare/IP” below.

2. **Configure the server as a DNS client as described in “Configuring a DNS Client” on page 101.**
3. **Configure the NetWare/IP server as described in “Configuring a NetWare/IP Server” on page 101.**
4. **Start the NetWare/IP server as described in “Starting the NetWare/IP Service” on page 102.**
5. **Press <Esc> as needed to exit the NetWare/IP Configuration utility and return to the Install utility.**

When to Install NetWare/IP

Generally, you should install NetWare/IP if the server will service IP-based network clients or if the server will function as a gateway between an IPX network and a TCP/IP network.

Before you decide to install NetWare/IP during a NetWare 4 installation, however, consider the following:

- ◆ The NetWare/IP software must be installed and configured in a specific manner. Prior to installing a NetWare/IP network, you should be familiar with the information presented in the *NetWare/IP Administrator’s Guide*.
- ◆ The NetWare/IP service relies on two other services: the Domain Name System (DNS), which is optional, and the Domain SAP/RIP Service (DSS). DSS must be running on the network before the NetWare/IP service can initialize. DNS is not required, but it can be running.
- ◆ If you plan to install NetWare/IP in a TCP/IP-only environment, you must install NetWare 4 and NetWare/IP at the same time. NetWare/IP provides the TCP/IP transport that the NetWare server needs to communicate with the existing network. During

installation, a NetWare 4 server needs to communicate with the network to configure itself as part of the Directory tree.

- ◆ If you are installing the first server in a TCP/IP-only network or if DNS (optional) and DSS are not already running on the network, you need to complete the tasks described in “Installing the First Server in a TCP/IP-only Network” on page 100.

Installing the First Server in a TCP/IP-only Network

If you are installing the first NetWare 4 server in a TCP/IP-only network or if DNS and DSS are not already running on the network, use the following procedure to set up a NetWare DNS or DSS server:

Procedure

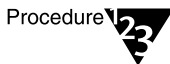

- 1. Install NetWare 4 as described in this chapter.**

When prompted to configure transport protocols, choose to use and configure the TCP/IP transport. When prompted to install NetWare/IP, do not configure or start the NetWare/IP service.

Because you do not start the NetWare/IP service, you cannot connect to an existing network, so you can't place an object that represents the server in an existing Directory tree.

- 2. After successfully installing NetWare 4, install the NetWare/IP software as described in “Installing NetWare/IP on a NetWare 4 Server” in the *NetWare/IP Administrator's Guide*, but do not configure or start the NetWare/IP service.**

The software necessary to configure and initialize a DNS name server or DSS server is installed along with the NetWare/IP software.

- 3. At the new server, use UNICON to configure and launch the NetWare DNS and DSS server software.**

For information on configuring a NetWare DNS server, see Chapter 7, “Setting Up DNS Support” in the *NetWare/IP Administrator's Guide*. For information on configuring a DSS server, see Chapter 8, “Configuring the Domain SAP/RIP Service” in the *NetWare/IP Administrator's Guide*.

4. **At the new server, use NWIPCFG or UNICON to configure and launch the NetWare/IP server.**

For information on configuring the NetWare/IP server, see Chapter 9, “Configuring NetWare/IP Servers” in the *NetWare/IP Administrator’s Guide*.

Configuring a DNS Client

To configure the server as a DNS client or resolver, complete the following steps:

Procedure

Procedure



1. **From the NetWare/IP Administration menu, choose the *Configure DNS Client* option.**

If the computer on which you are installing NetWare was an IP-based workstation, Install detects the previous DNS client configuration. Unless you want to change this configuration, you can simply confirm the current configuration.

2. **Enter the name of the DNS domain to which this server belongs.**
3. **Enter the IP address(es) of the DNS name server(s) this server should contact to resolve DNS queries.**
4. **To exit the DNS Client Access form, press <Esc>.**

Configuring a NetWare/IP Server

To configure the NetWare/IP server, complete the following steps:

Procedure

Procedure



1. **From the NetWare/IP Administration menu, choose the *Configure NetWare/IP Server* option.**

If the computer on which you are installing NetWare was a NetWare/IP client, Install detects the NetWare/IP domain to which the client belonged. If the server is to use the same domain and you don’t want this server to act as a forwarding gateway, you can simply confirm the current configuration.

2. Enter the name of the NetWare/IP domain to which this server belongs.
3. To configure the NetWare/IP server as a forwarding gateway, move the cursor to the *Forward IPX Information to DSS* field, press <Enter>, and choose “Yes.”
4. To exit the NetWare/IP Server Configuration form, press <Esc> and choose “Yes.”

Starting the NetWare/IP Service

To start the NetWare/IP service, complete the following steps:

Procedure

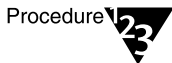

1. From the NetWare/IP Administration menu, choose the *Start NetWare/IP Server* option.
2. Press <Esc> to continue.
3. If you are installing from a remote network installation, continue with “Establish Server-to-Server Session (Conditional)” below.

Figure 3-26

Verify the Path Before Copying

Note: NetWare files will be installed from path:

NW411\INSTALL\ENGLISH\

You may change this path now if necessary. On CD-ROM, this should be path <drive_or_vol>:\PRODUCTS\NW411\INSTALL\IBM\<DOS_or_OS2>\XXX\<language>.

Press <F3> to specify a different path:

Press <Enter> to continue.

Procedure

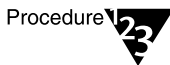

1. **Verify or change the source path and press <Enter>.**

At this time, NetWare copies only the SYSTEM and LOGIN files necessary to continue the installation as shown in Figure 3-27. Later, after Novell Directory Services has been installed, the remaining files, are also copied.

Figure 3-27

The Files Needed to Continue are Copied

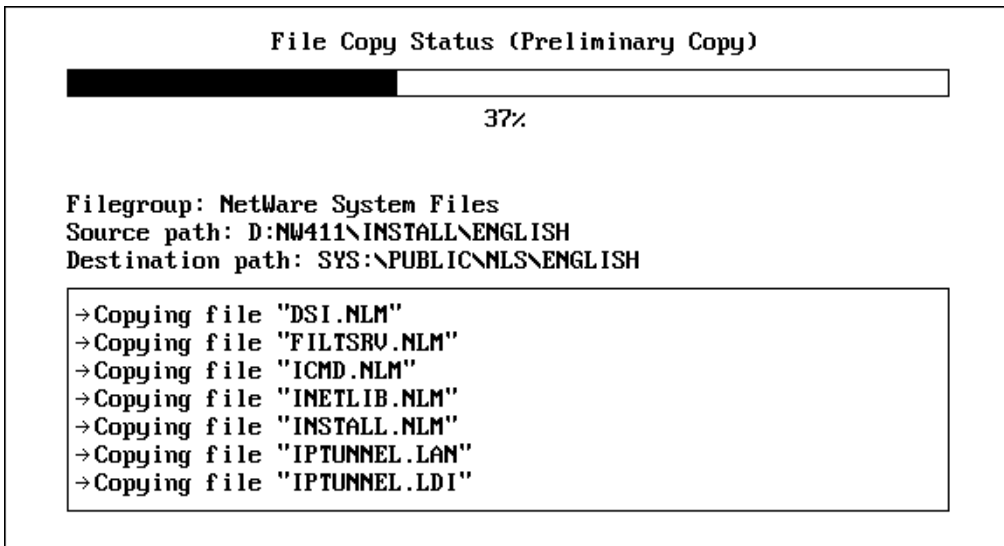

2. Continue with "Installing Novell Directory Services" below.

Installing Novell Directory Services

Once the preliminary files have been copied to the server, the network is scanned for Directory trees. Unless you are installing the first NetWare 4 server in the network, you will most likely want to install the server into an existing Directory tree.



If you are using Install to restore your server after a planned backup or for disaster recovery, there are prompts you can follow throughout the process of installing Novell Directory Services. For more information about the circumstances and requirements for backing up and restoring your server, whether the restoration is planned or unplanned, please see "Restore Server from Backup (Optional)" on page 123.

Based on your network configuration, one of the following screens appears:

Figure 3-28
When No Directory
Tree Is Located

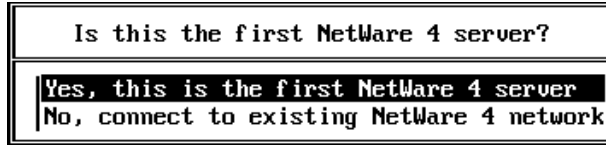

If no NetWare 4 server (and accompanying Directory tree) can be located on the network, the menu above appears.

If you want to	Then
Install the first NetWare Server	Go to "Install the First NetWare 4 Server" on page 107.
Connect to an existing NetWare 4 network	Go to "The Server Cannot Locate a Previously Installed Directory Tree" on page 108.
Use Install to restore Directory Services	Press <F3> here and go to "Restore Server from Backup (Optional)" on page 123.

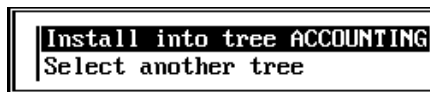

If a single Directory tree is located, the Directory tree name is displayed as in the menu above.

If you want to	Then
Install into the displayed directory tree	Go to "Install into the Single Existing Directory Tree" on page 109.
Select another tree	Go to "The Server Cannot Locate a Previously Installed Directory Tree" on page 108.

If you want to	Then
Create a new directory tree	Choose "Select another tree" and press <Enter>. Press <Ins>, and then at the confirmation prompt, press <Enter>. Follow the procedures under "Install the First NetWare 4 Server" on page 107.
Use Install to restore Directory Services	Press <F3> here and go to "Restore Server from Backup (Optional)" on page 123.

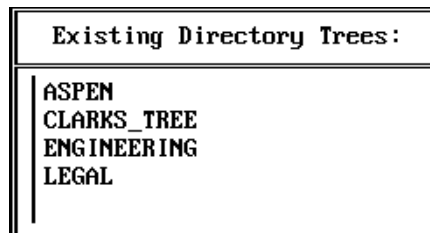

If multiple Directory trees are located, they are displayed as in the menu above.

If you want to	Then
Install into one of the existing Directory trees	Continue with "Install into an Existing Directory Tree" on page 111.
Use Install to restore Directory Services	Press <F3> here and go to "Restore Server from Backup (Optional)" on page 123.

Install the First NetWare 4 Server

Procedure

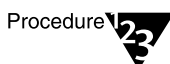

1. From the "Is this the First NetWare 4 Server?" menu choose "Yes, This Is the First NetWare 4 Server" and press <Enter>.

The following screen appears, ready for you to name your new Directory tree.

Figure 3-29
Enter a Name for the Directory Tree

Enter a name for this Directory tree
>_

For help on rules for naming a Directory tree, press <F1>.

2. Specify the Directory tree name and press <Enter>.

Each Directory tree (hierarchy of the Novell Directory database) must have a name that's unique across the internetwork. (Most organizations will have only one Directory tree.)

The tree name

- ◆ Enables client workstations to access data on multiple servers in a Directory tree without logging in to each server.
- ◆ Enables client workstations to log in to different Directory trees by specifying the tree name.

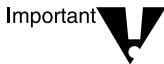

Each Directory tree has its own database of objects that is not visible from another tree. Be aware of this limitation before creating multiple Directory trees.

Once a Directory tree name has been entered, a list of time zones appears. (This list does not contain all existing time zones.)

3. Continue with “Set Up Time Synchronization” on page 112.

The Server Cannot Locate a Previously Installed Directory Tree

Procedure



- 1. From the “Is This the First NetWare 4 Server?” menu, choose “No, Connect to Existing NetWare 4 Network” and press <Enter>.**

The following menu appears:

Figure 3-30
Choose NetWare 4
Network Menu

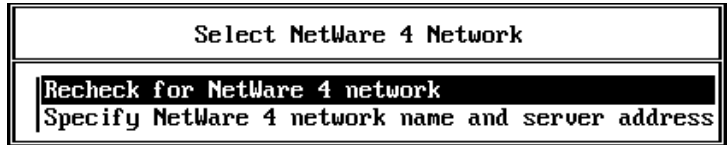

You can find out the network name by loading MONITOR.NLM on an existing server on the network. The network name is the same as the Directory tree name.

2. Choose one of the menu options.

If	Then
You have verified that an existing NetWare 4 server is up and physically connected to this server, and that both servers are bound to IPX with the proper LAN driver, frame type, and IPX external network number	Choose "Recheck for NetWare 4 Network" and press <Enter>.
	If a single Directory tree is located, go to "Install into the Single Existing Directory Tree" on page 109.
	If multiple Directory trees are located, go to "Install into an Existing Directory Tree" on page 111.
Your network has SAP filtering and you know the IPX internal network number of an existing NetWare 4 server	Choose "Specify NetWare 4 network name and server address" and press <Enter>.
	Enter the name of the Directory tree and press <Enter>.
	Enter the IPX internal network number of an existing NetWare 4 server in the Directory tree and press <Enter>.
	If a single Directory tree is located, go to "Install into the Single Existing Directory Tree" on page 109.
	If multiple Directory trees are located, go to "Install into an Existing Directory Tree" on page 111.

Install into the Single Existing Directory Tree

Install the new NetWare 4.11 server into the single Directory tree displayed in the menu below by completing the following procedures.

```
Install into tree ACCOUNTING
Select another tree
```

Procedure



1. Choose **“Install into Tree *tree name*”** and press <Enter>. A list of time zones appears.
2. Continue with **“Set Up Time Synchronization”** on page 112.

Install into an Existing Directory Tree

Install the new NetWare 4.11 server into one of the Directory trees displayed in the menu below by completing the following procedures.

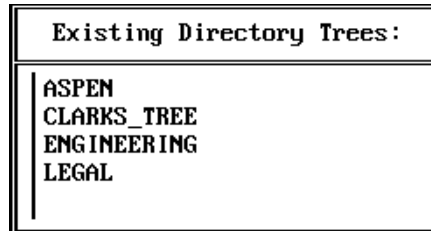

Procedure

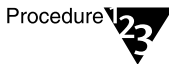

1. **Choose the Directory tree you want this server to be part of.**

A list appears of all Directory trees that are visible from this server. Most organizations will have only one Directory tree. The tree name is established during the installation of the first NetWare 4.11 server in a tree.



Make sure you choose the correct Directory tree name. If your organization has more than one tree, attaching to the wrong tree or creating a new Directory tree will prevent this server from sharing data within the desired Directory database.

Choosing an existing tree makes this new server part of that tree's Novell Directory database.

If	Then
(Conditional) The Directory tree you want this server to be a part of is not displayed, and you have verified that an existing NetWare 4 server in that tree is up and physically connected to this server, and that both servers are bound to IPX with the proper LAN driver, frame type, and IPX external network number	Press <F4> to rebuild the list

If	Then
(Conditional) Your network has SAP filtering and you know the IPX internal network number of an existing NetWare 4 server	Press <F3> and enter the name of the Directory tree and press <Enter> Then enter the IPX internal network number of an existing NetWare 4 server in the Directory tree and press <Enter>.
You need to create a new Directory tree on the network	Press <Ins>. At the confirmation prompt, press <Enter>. Continue with "Install the First NetWare 4 Server" on page 107.

2. Continue with "Set Up Time Synchronization" on page 112.

Set Up Time Synchronization

Time synchronization is important to NDS, because it

- ◆ Monitors and adjusts a NetWare server's internal time to ensure consistency of reported time across the network.
- ◆ Indicates when a server's time is synchronized with the rest of the network.
- ◆ Provides time stamps to establish the order of events in the Directory.



Setting up time synchronization incorrectly can cause network synchronization problems within the Directory database.

For more information on time synchronization, see "Planning the Time Synchronization Strategy" in *Guide to NetWare 4 Networks*, "Maintaining NetWare 4 Networks" in *Supervising the Network*, and "Time Synchronization" in *Concepts*.

To enable time synchronization, you need to specify

- ◆ What time zone the server will be in.
- ◆ What type of time server category this server falls into.

- ◆ Whether the server is in a zone that observes daylight saving time.

Procedure

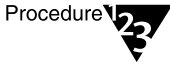

1. Choose the time zone this server is installed in.

If the time zone	Then
Is listed	Move the cursor to the appropriate time zone and press <Enter>. Verify that the information presented is correct. If it is, continue with Step 11 on page 116. If it isn't correct, follow Step 2 through Step 11.
Is not listed	Press <Ins> and continue with Step 2.

2. At the “Time Configuration Parameters” screen, verify or specify time synchronization parameters.

The following screen appears with the cursor in the “Standard Time Zone Abbreviation” field:

Figure 3-31
Time Configuration Screen

Verify/Enter Time Configuration Information for This Server

Time server type: Single reference

Standard time zone abbreviation: ████████████████████

Standard time offset from UTC:

Does your area have daylight saving time (DST):

DST time zone abbreviation:

DST offset from standard time:

DST Start:

DST End:

3. (Conditional) If you want to choose a different time server type, highlight the “Time Server Type” field and press <Enter>.

There are four time server types:

- ◆ Single Reference
- ◆ Reference
- ◆ Primary
- ◆ Secondary

The default sets the first NetWare 4.11 server in a Directory tree as a Single Reference server. All other servers default as Secondary servers.



Do not change the time server defaults without a clear understanding of time server types. Press <F1> for help, or refer to “Planning the Time Synchronization Strategy” in *Guide to NetWare 4 Networks* for a description of these time server types.

4. In the “Standard Time Zone Abbreviation” field, enter the three-letter abbreviation for your standard time zone and press <Enter>.

Not all time zones have agreed-upon abbreviations. Time zone information is subject to local custom and national rules. Find out what the commonly used abbreviation for your standard time zone is, or enter your own abbreviation.

The time information you specify is saved in this server’s AUTOEXEC.NCF file. You can change it later by editing this file (see “Modify the AUTOEXEC.NCF File” on page 127).

5. In the “Standard Time Offset from UTC” field, enter the offset (in hours) from UTC (Universal Coordinated Time, formerly known as Greenwich Mean Time) and press <Enter>.

If your time zone is east of UTC, use “AHEAD” with the number, since your time is ahead of UTC. For example, in Germany, you would type “1” and then press <Enter> to toggle to “AHEAD.”

If your time zone is west of UTC, toggle to “BEHIND,” because your time is behind UTC.

Use the following illustration to find your time zone’s offset from UTC.

Figure 3-32
World Time Zones and Their Offsets
from UTC

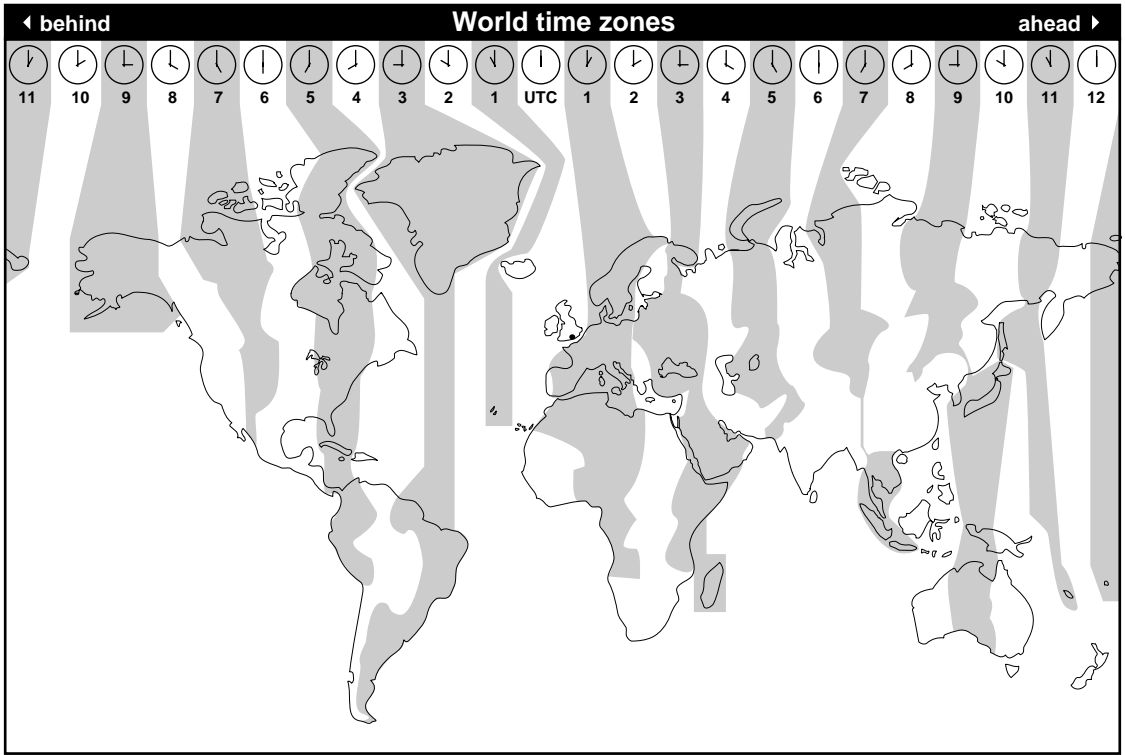

6. In the “Does Your Area Have Daylight Saving Time (DST)” field, press <Enter> and use the arrow keys to toggle between “Yes” and “No.”

Table 3-3
Daylight Saving Time Options

If	Then choose	And then
Your time zone switches to daylight saving time (and back to standard time) during each year	Yes	Continue with Step 7.
Your time zone never switches to daylight saving time	No	Go to Step 11.



- 7. In the “DST Time Zone Abbreviation” field, enter the three-letter abbreviation your time zone uses during daylight saving time and press <Enter>.**

If you do not specify the abbreviation for daylight saving time, the server won't automatically adjust for the seasonal change. Internal algorithms assume that if no DST abbreviation is specified, local custom is to not observe DST.

Not all time zones have agreed-upon abbreviations. Time zone information is subject to local custom and national rules. Find out what the commonly used abbreviation for your daylight saving time zone is, or enter your own abbreviation.

- 8. In the “DST Offset from Standard Time” field, enter the difference between standard time and daylight saving time and press <Enter>.**

Enter the offset in hours:minutes:seconds. The default is 1:00:00 (one hour) *ahead*, meaning that your daylight saving time is one hour ahead of your standard time.

If daylight saving time in your area varies from your standard time by more or less than the default (one hour), enter a different time offset.

- 9. In the “DST Start” field, specify the starting day for daylight saving time and press <Enter>.**

Follow the screen prompts to decide which format to use.

- 10. In the “DST End” field, specify the day daylight saving time ends and press <Enter>.**

Follow the screen prompts to decide which format to use.

- 11. Save the time configuration information by pressing <F10> and then <Enter>.**

If	Then
You are installing a first NetWare server	Continue with “Specify the Server’s (Name) Context” on page 117.

If	Then
You are installing into an existing Directory tree	The screen below appears. Continue with Step 12, before going to “Specify the Server’s (Name) Context” below.

Figure 3-33
Directory Services Login/Authentication

Directory Services Login/Authentication
Administrator Name: CN=Admin.O=Novell Password:

12. **(Conditional)** If you are installing into an existing Directory tree, type the administrator name (if necessary) and press <Enter>, and then type the administrator password and press <Enter>.

Specify the Server’s (Name) Context

The server context, or name context, specifies where the server is located in the hierarchical Directory tree. The context is composed of

- ◆ A company or organization name (example: O=Novell).
- ◆ Optional names of organizational units and subunits, such as divisions or departments (example: OU=Sales).
- ◆ An optional country code (example: C=US).

For recommendations on how to lay out your Directory tree, see “Designing the Directory Tree Structure” in *Guide to NetWare 4 Networks*.

For example, if your NetWare server were located in the “Sales_LA” group of the Sales department of a company called “Novell_US,” the server’s context would look like this:

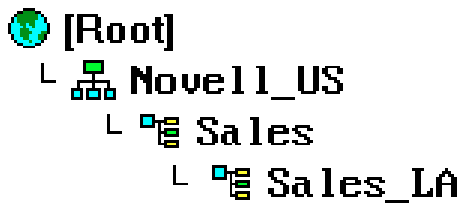

OU=Sales_LA.OU=Sales.O=Novell_US

The object “[Root]” is automatically created during NDS installation.

For more information on context and naming conventions, see “Designing the Directory Tree Structure” in *Guide to NetWare 4 Networks* and “Context” in *Concepts*.

Depending on whether you are creating a new tree or installing into an existing tree, one of the following screens prompts you to specify the server’s NDS context:

Figure 3-34
Server Context Screen for a New Tree

```

Company or Organization:
Level 1 (Sub)Organizational Unit (optional)
Level 2 (Sub)Organizational Unit (optional)
Level 3 (Sub)Organizational Unit (optional)

Server Context:

Administrator Name:
Password:
  
```

Figure 3-35
Server Context Screen for an Existing Tree

```

Company or Organization: NOVELL
Level 1 (Sub)Organizational Unit (optional)
Level 2 (Sub)Organizational Unit (optional)
Level 3 (Sub)Organizational Unit (optional)

Server Context: NOVELL
  
```

Procedure

Procedure



1. In the “Company or Organization” field, accept the current name or type your company or organization name and press <Enter>.

Only valid characters (letters A through Z or a through z, numbers 0 through 9, hyphen, underscore) can be used.

2. (Optional) In the “Level 1 (Sub)Organizational Unit” field, type in an Organizational Unit name (such as a division or a department) and press <Enter>.

Use this name to further specify your Directory tree. This could be a division name, a locality name, a department name, or anything that reflects your organization’s structure.

Notice that the information in the “Server Context” field is updated every time you enter a new name.

3. (Optional) In the “Level 2 (Sub)Organizational Unit” field, type in an additional Organizational Unit name and press <Enter>.

4. (Optional) In the “Level 3 (Sub)Organizational Unit” field, type in an additional Organizational Unit name and press <Enter>.

You can manually enter more than three levels of Organizational Units (up to 25) into the “Server Context” field. Make sure you enter a period (.) as a delimiter between each new name entry. For example, if you wanted to create a fourth Organizational Unit level in Figure 3-40 on page 130, you would type OU=*organizational unit name* (followed by a period) on the left end of the context.

5. (Optional) Return to the “Server Context” field and type a country code or additional Organizational Units and press <Enter>.

Enter the country code after the company name, separated by a period. For example, if your country is France, add “.C=FR” to the end of the server context.

Although a country code is not required, it can be useful in a multinational organization.



For a list of country codes, see Appendix C, “Country Codes,” on page 229.

Adding a country name to the context may create some problems with default naming in some NetWare 4.11 utilities because the utilities assume the highest level to be *O=organization*.

That means that if you use Country in the Directory tree, you always have to include name typing (CN=.OU=.O=) whenever you log in or refer to an object name in the tree, regardless of what context you or the other object are in.

For example, if you included the country code for the United States (US), the object name for Dave Smith might be

```
CN=DSMITH.OU=ACCOUNTING.O=NOVELL.C=US
```

For more information, see “Designing the Directory Tree Structure” in *Guide to NetWare 4 Networks* and “CX” in *Utilities Reference*.

- 6. (Conditional) If this the first NetWare server in the tree, record the administrator’s name on the NetWare 4.11 Server Worksheet (see Figure 3-42 on page 141).**

The default common name (CN) for the administrator of the first NetWare 4.11 server in a Directory tree is ADMIN. Install creates this User object ADMIN directly under the Organization (O=) level.

The administrator can

- ◆ Manage this Server object.
- ◆ Manage User objects in this container.
- ◆ Manage the Directory tree (only applies to ADMIN created on the first NetWare 4.11 server).

You can change the name of user ADMIN using the NETADMIN (or NetWare Administrator) utility after the server is installed and you have set up a workstation.

- 7. (Conditional) If this is the first NetWare server in the tree, type the administrator’s password and press <Enter>.**
 - 7a. At the prompt, retype the password and press <Enter>.**
 - 7b. (Optional) Record the password on the NetWare 4.11 Server Worksheet (see Figure 3-42 on page 141).**

This password is also the password for the bindery user SUPERVISOR. If you change the administrator password later, the SUPERVISOR password will not change until you change it using either the NETADMIN or NWADMIN utility.

8. To save Directory information, press <F10>.

If	Then
You are installing the first NetWare server in the Directory tree	A message appears indicating that Novell Directory Services is being installed.
You are installing into an existing Directory tree	A confirmation menu appears. Press <Enter> to choose "Yes."

9. Continue with "Review the Created Directory Tree (Optional)" on page 121 and "Review the Trustee Assignments Created (Optional)" on page 122. Then continue with "Install the License Server" on page 124.

Review the Created Directory Tree (Optional)

The following objects were created in the Directory tree:

- ◆ Server object.
- ◆ Volume objects (*servername_SYS* and other volumes you specified).
- ◆ User object ADMIN (the administrator who has Supervisor object rights to this context). Install places this object directly under the Organization level.
- ◆ User object ADMIN is created only once, and only on the first server in the Directory tree.
- ◆ User object Supervisor (for bindery services purposes only). This object can be recognized only from pre-NetWare 4.11 utilities. User object Supervisor takes on User object ADMIN's password.

These objects are placed in the same context you defined for your server. The following illustration shows what your Directory tree might look like after you installed your first NetWare 4.11 server.

Figure 3-36
Example of a
Directory Tree

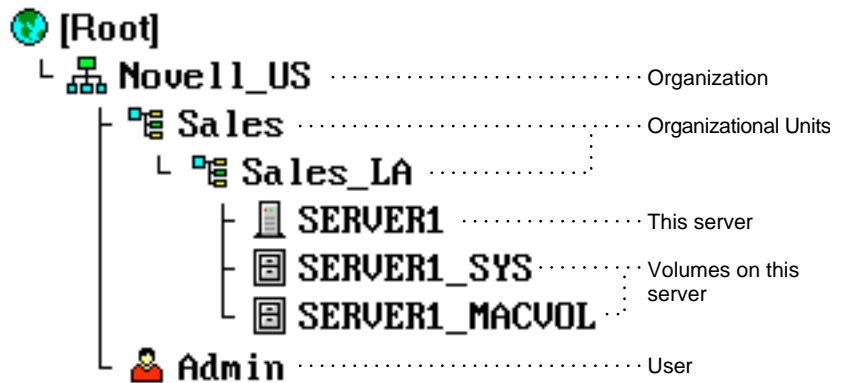

Review the Trustee Assignments Created (Optional)

- ◆ User object ADMIN has the Supervisor object right on the [Root] object. By inheritance, ADMIN also has the Supervisor right on all Volume objects in the Directory.
- ◆ [Public] has the Browse right on the [Root] object.
[Public] is equal to the group EVERYONE in the NetWare 3 environment.
- ◆ Any container object has Read and File Scan rights to the PUBLIC directories of all system volumes in that container.
- ◆ The [Root] object (or security equivalent) of a tree has the Browse right on all User objects in that tree. This can be blocked by an Inherited Rights Filter or removed from a container's trustee list (ACL).
- ◆ The [Root] object has the Read right to the member property of any Group object.

- ◆ The [Root] object has the Read right to the following properties of any Volume object: host server name (the server that the physical volume resides on) and host resource (the physical volume).
- ◆ All User objects have the Read right to their own properties and to the properties of any profile they belong to. User objects also have Read and Write rights to their user login scripts.



For more information on rights and trustee assignments, see “Rights” and “Trustee” in *Concepts* and Chapter 2, “Managing Directories, Files, and Applications,” and Chapter 3, “Creating Login Scripts,” in *Supervising the Network*.

Restore Server from Backup (Optional)

Install for NetWare 4.11 allows you to restore Directory Services whether you planned for a hardware upgrade and backed up your directory services or your server experienced a failure.

If you planned to upgrade your hardware and backed up your server with the intention of restoring it, a BACKUP.NDS file exists from which the server directory services can be restored. In order to complete the restoration, find where this file is stored.

If this is a restoration of a server in an unplanned circumstance, find the location of the SERVDATA.NDS file that was created during your normal backup process.

When you press <F3> or <F5>, a screen appears indicating a path from which Novell Directory Services server configuration information is restored.

Procedure

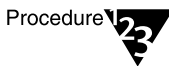

1. **Accept the path or specify a new one.**
2. **Follow the procedure as written in chapter 9, “Backing Up and Restoring Data” in *Supervising the Network*.**

Install the License Server

After Directory Services has been installed, the screen below appears, prompting you to insert the license diskette and install the NetWare 4.11 license server:

Figure 3-37

Insert the *License* Diskette when Prompted

```
The license file will be installed from drive A:. Insert disk "MAIN
SERVER LICENSE" (which contains the file "SERVER.MLS") into the drive.

Warning: Do not try to install this same license on any
other server.
Doing so will cause a copyright violation warning to be issued.

Press <F3> to specify a different path;
Press <Enter> to continue.
```

Procedure

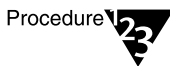

1. Insert your *License* diskette into drive A:.

A message appears that the server license was successfully installed. As you continue the installation, a prompt to log in as a network administrator or the equivalent appears.

2. Remove the *License* diskette and store it in a safe place.



Be sure to keep your *License* diskette as a backup. You may need it in the future if your installed license should get corrupted.

3. Continue with “Modify the STARTUP.NCF File” below.

Modify the STARTUP.NCF File

The STARTUP.NCF file resides on the boot disk partition, together with SERVER.EXE. It executes immediately after SERVER.EXE.

The STARTUP.NCF file contains the commands to load the disk drivers you specified under “Load Disk Drivers.” You can add other commands to this file or delete existing ones. However, since deleting commands could cause problems, make sure you know what you are deleting.

A sample STARTUP.NCF file is shown in Figure 3-38 below.

Figure 3-38

Sample STARTUP.NCF File

File: STARTUP.NCF
Load IDE INT=E PORT=1F0 Load Mac Load AHA1740 SLOT=3 Load ASPICD Set Reserved Buffers Below 16 MEG=200

Volume SYS: is automatically mounted when its corresponding disk driver is loaded during the STARTUP.NCF file's execution.

The following table shows some of the commands you can add to the STARTUP.NCF file.

Table 3-4
Syntax Examples for Assorted Commands

If you want to	Add these or other commands
Load name spaces for Macintosh, OS/2, UNIX, or FTAM	LOAD MAC.NAM LOAD OS2.NAM LOAD NFS.NAM LOAD FTAM.NAM These commands must precede the command to mount the volume that stores the files using the name space.
Set server parameters	You can add the following six SET commands to the STARTUP.NCF file only. You can add other SET commands to either the STARTUP.NCF or the AUTOEXEC.NCF file. SET Maximum Physical Receive Packet Size SET Auto Register Memory Above 16 Megabytes SET Reserved Buffers Below 16 Meg SET Maximum Subdirectory Tree Depth SET Auto TTS Backout Flag SET Minimum Packet Receive Buffer (For more information on these and other SET commands, see "SET" in <i>Utilities Reference</i> or type "SET" at the server console.)
Pause after each command	PAUSE

Procedure

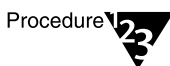

1. **Type one command on each line.**
Table 3-4 on page 126 gives some syntax examples for assorted commands.
2. **To delete or modify commands, simply backspace to erase the command.**
3. **When you're finished modifying the file, press <F10>.**
4. **When asked whether you want to save the file, choose "Yes."**

For more information on	See
Editing the STARTUP.NCF file through INSTALL.NLM	“Creating or Editing a Server Batch (.NCF) File” in Chapter 7 of <i>Supervising the Network</i> .
Editing the STARTUP.NCF file using SERVMAN	“SERVMAN” in <i>Utilities Reference</i> .

If you make changes to this file, they take effect only when you reboot the server after the installation is finished.

5. Continue with “Modify the AUTOEXEC.NCF File” below.

Once STARTUP.NCF loads disk drivers and any name spaces you add to it, control is passed to the AUTOEXEC.NCF file to complete the boot process.

You can also add commands to the STARTUP.NCF file by loading INSTALL.NLM, or by using the SERVMAN server utility. For further information, see the *Utilities Reference*.

Modify the AUTOEXEC.NCF File

The AUTOEXEC.NCF file is located in the SYS:SYSTEM directory. It runs after the server has mounted the system volume (volume SYS:). It provides the NetWare server with commands to complete the boot process after SERVER.EXE and STARTUP.NCF are executed.

A sample AUTOEXEC.NCF file is shown in Figure 3-39 below.

Figure 3-39
Sample AUTOEXEC.NCF File

```
New File: AUTOEXEC.NCF

set Time Zone = MST7MDT
set Daylight Savings Time Offset = 1:00:00
set Start Of Daylight Savings Time = (APRIL SUNDAY FIRST 2:00:00 AM)
set End Of Daylight Savings Time = (OCTOBER SUNDAY LAST 2:00:00 AM)
set Default Time Server Type = SINGLE
file server name SERVER1
ipx internal net 1D0C38A
LOAD NE2000 INT=3 PORT=300 FRAME=Ethernet_802.3 NAME=NE2000_1_E83
BIND IPX NE2000_1_E83 NET=1D0C301
```

The AUTOEXEC.NCF file displays commands you specified earlier in the program. These include:

- ◆ Time zone SET commands (time server type, time zones, daylight saving time status and offset).
- ◆ Bindery context (for bindery services, set automatically at this server's context).

Users logging in, attaching, or mapping to a NetWare 4.11 server from a client running NETX rather than VLMS need to use the bindery context set in the server's AUTOEXEC.NCF file.

- ◆ Server name.
- ◆ IPX internal network number.
- ◆ All LOAD and BIND commands for LAN drivers, protocols, and frame types.

Following are some of the commands you can add to the AUTOEXEC.NCF file:

If you want to	Add these or other commands
Load other modules (NLMs) when the server boots	LOAD MONITOR LOAD <i>NLMname</i>
Mount volumes	MOUNT <i>volumename</i> MOUNT ALL Note: Volume SYS: is automatically mounted when its corresponding disk driver is loaded during the STARTUP.NCF file's execution.
Set server parameters, including time synchronization parameters	For a complete list of all available SET commands, see "SET" in <i>Utilities Reference</i> .
Execute any other valid console commands during the boot process	SECURE CONSOLE
Pause after a command	PAUSE

If you make changes to the AUTOEXEC.NCF file, they take effect only when you reboot the server after the installation is finished.

You can also add commands to the AUTOEXEC.NCF by loading INSTALL.NLM at the server (see "Creating or Editing a Server Batch (.NCF) File" in Chapter 7 of *Supervising the Network*), or the SERVMAN server utility (see "SERVMAN" in *Utilities Reference*).

Procedure

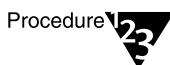

1. Press the Up-arrow or Down-arrow keys to edit specific commands in the AUTOEXEC.NCF file.
2. Verify the syntax for the command in *Utilities Reference*.
3. To add commands, type one command on each line.
4. To delete or modify commands, simply backspace or press delete to erase the command.

5. When you're finished modifying the file, press <F10>.
6. When asked whether you want to save this file, choose "Yes."

The remaining NetWare files are copied to the server as shown in Figure 3-40. This could take a few minutes.

Figure 3-40
The Remaining NetWare Files Are Copied to the Server

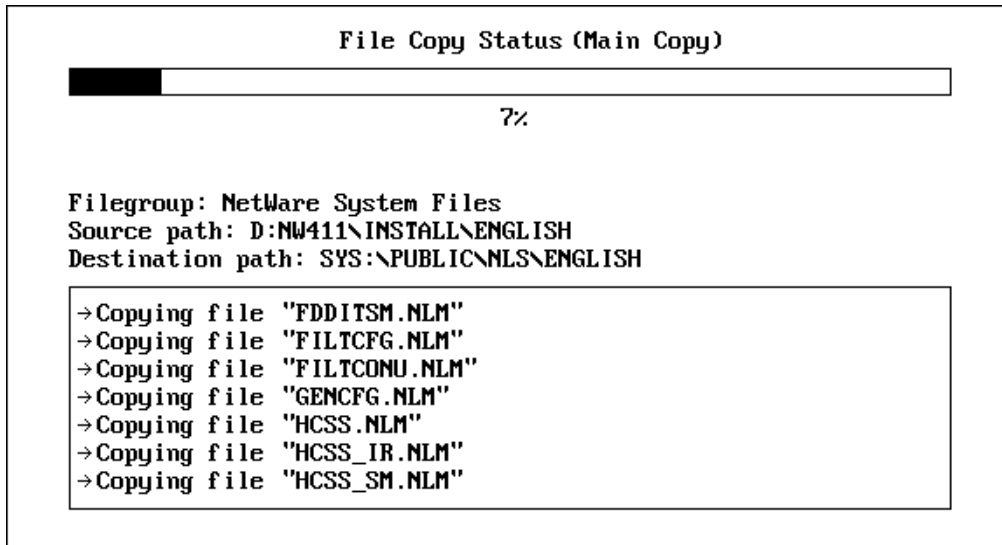

After these files are copied, the server installation is essentially complete.

If you want, you can install additional items or products (see "Perform Other Installation Options (Optional)" on page 131).

Perform Other Installation Options (Optional)

The following screen appears listing other installation options:

Figure 3-41
Other Installation
Options



All of the options listed above can be performed at any time from the server by loading INSTALL.NLM at the server console.

If	Then
You want to perform any of the listed installation actions at this time	Follow the procedures under the heading in this section that corresponds to the option you choose.
You want to install an optional product not listed	Choose "Install a Product Not Listed" from the "Other Installation Options" menu. Then follow the server prompts.
You do not want to perform any of the listed installation actions at this time	Choose "Continue Installation" from the "Other Installation Actions" menu and press <Enter>. After being prompted that the installation is complete, press <Enter> to get to the server console. Go to "Where to Go from Here" on page 140.

Create a Registration Diskette

Having a *Registration* diskette is useful in case you experience system problems in the future and must call Novell Technical SupportSM.

Install can read information such as OS version, addresses, number of licensed connections, SFT level, amount of RAM installed, network board configuration, and disk drive configuration, and it can copy this information to the *Registration* diskette.

Novell support technicians can access the above information, which greatly speeds up their ability to help you.

Procedure

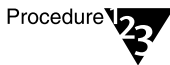

1. From the “Other Installation Actions” menu, choose “Choose an Item or Product Listed Above” and press <Enter>.
2. Choose “Create a Registration Diskette” and press <Enter>.

The screen that appears lists three prerequisites:

- ◆ The NetWare 4.11 *Registration* diskette
 - ◆ The name and address of your Novell Authorized Reseller^{CLM}
 - ◆ Your company’s reseller contact (the person in your company in responsible for purchases).
3. Press <F10> to continue.
 4. In the “Reseller Information” form that appears, fill in the name and address of the Novell Authorized Reseller you purchased NetWare 4.11 from.
 - 4a. Press <Enter> after each entry.
 - 4b. Press <F10> to continue.
 5. In the “Customer Information” form, fill in the reseller contact’s name and the name of your company (or organization).
 - 5a. Press <Enter> after each entry.

- 5b. Press <F10> to continue.**
- 6. Insert the *Registration* diskette into drive A: and press <Enter>.**

Install now copies the registration information to this diskette.
- 7. (Optional) Copy configuration information to the *Registration* diskette.**
 - 7a. Press <F2> to view configuration information.**
 - 7b. Press <Esc> to exit the screen.**
 - 7c. When asked “Copy This Information to the Diskette?” choose “Yes” or “No” and press <Enter>.**
 - 7d. Insert the *Registration* diskette into the mailer labeled “Product Registration” and send it to Novell.**
- 8. Continue performing any additional installation options under the headings in this section, or go to “Exit the Install Utility” on page 139.**

Upgrade 3.1x Print Services

This option allows system administrators upgrading their printer-supported NetWare 3.1x server to NetWare 4.11, to upgrade print configuration files.

Install NetWare for Macintosh

This option allows you to install NetWare for Macintosh on the NetWare 4 server. When you choose this option, a screen appears indicating the default path from which the files are copied or the option to choose a different path. The files are then copied. For more information on NetWare Client for Macintosh, see the *NetWare for Macintosh File and Print Services*.

Install NetWare Client for Mac OS

This option allows you to install NetWare Client for Mac OS. When you choose this option, a screen appears indicating the default path from which the files are copied or the option to choose a different path. The files are then copied. For more information on NetWare Client for Mac OS, see the *NetWare Client for Mac OS User Guide*.

Install NetWare IP

This option allows you to install NetWare IP. When you choose this option, a screen appears indicating the default path from which the files are copied or the option to choose a different path. The files are then copied. For more information on NetWare IP, see the *NetWare/IP Administrator's Guide* and "Internet Protocol" in *Concepts*.

Install NetWare DHCP

This option allows you to install NetWare DHCP (Dynamic Host Configuration Protocol). DHCP is a method of assigning IP addresses to hosts when the TCP/IP network clients contact the network rather than when the TCP/IP clients are configured.

When you choose this option, a screen appears indicating the default path from which the files are copied or the option to choose a different path. The files are then copied. For more information on NetWare DHCP, see Chapter 12, "Configuring a DHCP Server" in the *NetWare IP Administrator's Guide*.

Configure Network Protocols

Choosing this option loads the INETCFG.NLM, which allows you to configure the protocols you selected under "Load the LAN Drivers" on page 73 as routing protocols.

This means that the server will not only function as a NetWare 4.11 server, but will also route IPX™, TCP/IP, and AppleTalk* packets to other network segments.

Procedure

1. From the “Other Installation Actions” menu, choose “Choose an Item or Product Listed Above” and press <Enter>.
2. Choose “Configure Network Protocols” and press <Enter>.

A screen appears informing you that LAN driver, protocol or remote access commands in AUTOEXEC.NCF should be transferred to the configuration files maintained by INETCFG.NLM. After transfer, the information in these files is configurable from the INETCFG.NLM menu system. If you want to configure network protocols, you should respond “Yes.”

3. Use the table below to find out which manual to refer to for configuring the protocol.

For Configuring	See
IPX	<i>NetWare IPX Reference.</i>
TCP/IP	<i>NetWare TCP/IP Reference.</i>
AppleTalk	<i>NetWare AppleTalk Reference.</i>

4. Continue performing any additional installation options under the headings in this section, or go to “Exit the Install Utility” on page 139.

Configure NetWare Licensing Service (NLS)

This option allows you to install NetWare Licensing Service (NLS). When you choose this option, a screen appears indicating the default path from which the files are copied or the option to choose a different path. After you choose the path, the files are copied, and a screen appears prompting for a Directory Services Login/Authentication name and password. After you enter this information, a final screen appears and asks you to respond “Yes” or “No” to allow the setup program to make modifications. If you want to configure NLS, you should respond “Yes.” For more information on NLS, see “NetWare Licensing Services” in *Concepts*.

Install an Additional Server Language

This option allows you to install message and help files for a selected language. You can later change the server language to display the installed language files through the “Change Server Language” option. When you choose this option, a screen appears indicating the default path from which files are copied or the option to choose a different path. The files are then copied.

Change Server Language

This option allows you to change the server language to a language selected earlier through the “Install an Additional Server Language” option.

Procedure

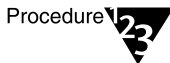

1. From the “Other Installation Actions” menu, choose “Choose an Item or Product Listed Above” and press <Enter>.

2. Choose “Change Server Language” and press <Enter>.

A screen appears indicating the default path from which files are copied or the option to choose a different path

3. Accept the path by pressing <Enter>, or press <F3> and indicate a new path.

A screen appears listing a number of languages you can choose from.

4. Choose the desired server language.

This must be a language that you installed earlier through the “Install an Additional Server Language” option (see “Install an Additional Server Language” on page 136).

The files are copied to the server. To have the server invoke the new language, bring down the server and then bring it back up.

5. Continue performing any additional installation options under the headings in this section, or go to “Exit the Install Utility” on page 139.

Set Up a Network Directory for Client Install

This option allows you to set up a network directory for client Install.

Procedure

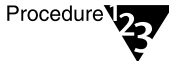

1. From the “Other Installation Actions” menu, choose “Choose an Item or Product Listed Above” and press <Enter>.
2. Choose “Set Up a Network Directory for Client Install” and press <Enter>.

A screen appears indicating the default path from which files are copied or the option to choose a different path.

3. Choose the path from which you want the files copied.

A menu appears showing a list of clients similar to the list in Table 3-5 below:

Table 3-5
Clients

For	Format
NetWare Client 32 Administrative Utility	Two 3.5 or 5.25 inch diskettes.
NetWare DOS/Windows Client (VLM)	Five 3.5-inch or 5.25 inch diskettes.
NetWare DOS/Windows Client (VLM) for IP	Five 3.5-inch or 5.25 inch diskettes.
NetWare Client 32 for DOS and Windows 3.1x	Five 3.5-inch or 5.25 inch diskettes.
NetWare Client 32 for Windows 95	Five 3.5-inch or 5.25 inch diskettes.
NetWare Client for OS/2	Eleven 3.5-inch or 5.25 inch diskettes.

4. Select or deselect the clients you want by pressing <Enter>.
5. Press <F10> to accept the marked clients and continue.

The client files are copied to a client directory on volume SYS:.

6. **Continue performing any additional installation options under the headings in this section, or go to “Exit the Install Utility” on page 139.**

Make Diskettes

This option allows you to make diskettes necessary to upgrade an existing NetWare 2.x, 3.x, or 4.x server to NetWare 4.11.

This option also allows you to make client diskettes. If you don't want to make client diskettes at this time, you can make them later from the server by loading INSTALL.NLM or from a workstation by running MAKEDISK.BAT. (See Appendix E, “Creating Client Diskettes,” on page 233.)

Prerequisites

To make client diskettes, format the appropriate number of high-density diskettes as prompted by the screen or as shown in Table 3-6 below.

Table 3-6
Formatted Diskettes for Clients

For	Format
NetWare Client 32 Administrative Utility	Two 3.5 or 5.25 inch diskettes.
NetWare DOS/Windows Client (VLM)	Five 3.5-inch or 5.25 inch diskettes.
NetWare DOS/Windows Client (VLM) for IP	Five 3.5-inch or 5.25 inch diskettes.
NetWare Client 32 for DOS and Windows 3.1x	Five 3.5-inch or 5.25 inch diskettes.
NetWare Client 32 for Windows 95	Five 3.5-inch or 5.25 inch diskettes.
NetWare Client for OS/2	Eleven 3.5-inch or 5.25 inch diskettes.



Procedure

1. From the “Other Installation Actions” menu, choose “Choose an Item or Product Listed Above” and press <Enter>.

2. Choose “Make Diskettes” and press <Enter>.

A menu appears showing a list of clients similar to the list in Table 3-6 above.

3. Select or deselect the clients you want to copy to diskette by pressing <Enter>.

4. Press <F10> to accept the marked clients and continue.

5. Specify the destination that the client files will be copied to.

By default, the client files are copied to drive A:. To specify a new path, press <F3> and type the new path.

6. Press <Enter> to accept the path.

7. Insert the labeled diskettes as prompted.

8. Continue performing any additional installation options under the headings in this section, or go to “Exit the Install Utility” on page 139.

Exit the Install Utility

The installation of the NetWare 4.11 server is now complete.

Procedure



1. To exit the Install utility and go to the server console, press <Enter>.

2. Continue with “Where to Go from Here” below.

Where to Go from Here

If you want to	Go to
Install additional NetWare 4.11 servers	"Install the Server Software" on page 60.
Install NetWare SFT III	Chapter 5, "Install NetWare 4.11 SFT III," on page 197.

Figure 3-42
NetWare 4.11 Server Worksheet

Server name: _____ **IPX internal network number:** _____
Server make/model: _____ **Tree name:** _____

Time server type: _____ **Time zone:** _____ **Offset from UTC** ____ ahead
 Daylight time zone: _____ ____ behind

Memory (RAM): Base: _____ Extended: _____ Total: _____

Server boot method: Hard disk Floppy diskette 3.5" 5.25"

Network boards (Fill in columns that apply to each network board.)

Name	LAN driver	I/O port	Memory address	Interrupt (IRQ)	DMA channel	Node address	Slot number	IPX external network #

Other boards (Internal or external disk controllers, serial controllers, SCSI controllers, video adapters, etc.)

Name	Driver (if applicable)	I/O port	Memory address	Interrupt (IRQ)	DMA channel	SCSI address	Other info

Disks

Drive Make/Model	Size	Mirrored with #	Volume segments
1.			
2.			
3.			
4.			
5.			
6.			
7.			
8.			

Volumes

Volume name	File compression		Block suballocation		Data migration		Name space
	ON	OFF	ON	OFF	ON	OFF	

Overview

The installation of NetWare Server for OS/2* consists of two parts:

- ◆ A graphical installation program that installs drivers and utility programs that allow NetWare 4™ to operate on an OS/2 computer. This chapter explains that installation.
- ◆ The NetWare® installation program that installs NetWare 4.11. That installation is explained in “Custom Installation” on page 59.

Necessary Resources

Hardware Requirements

Checklist



- A PC (or PC compatible) with a 386, 486 or pentium processor. In a large network, the first NetWare Server for OS/2 you install should have a fast processor for more efficient Novell Directory Services™ (NDS) synchronization.
- At least 32MB of RAM.
- A hard disk that is large enough to hold the OS/2 and NetWare operating systems. Partition the hard disk so that there is at least 150 MB free space for the NetWare Server for OS/2.

Note



- Although these minimum requirements will allow you to install OS/2 and NetWare Server for OS/2, Novell® recommends that you install a larger hard disk to accommodate your storage needs.
- (Conditional) If you install the NetWare 4 online documentation on the server, another 60 MB of disk space is required.

- If you want to share a network board between NetWare Client™ for OS/2 and NetWare Server for OS/2 (on the same computer), you need at least one network board. If you do not want to share a network board, you will need at least one network board for the client and one network board for the server.
- A CD-ROM drive (if installing from CD-ROM) with the corresponding OS/2 drivers.

Software Requirements



- OS/2 version 2.1x or later.
- If installing from CD-ROM, the *NetWare 4.11 Operating System* CD-ROM and the *NetWare 4 Online Documentation* CD-ROM.
- License* diskette.
- (Conditional) If you are sharing a network board between NetWare Client for OS/2 and NetWare Server for OS/2, and the client software has not been installed, you will need the latest version of the client software.
- (Optional) Working copies of NetWare 4.11 compatible third-party disk drivers, LAN drivers, or NetWare Loadable Modules™ (NLMs™).

Install Server Software

For help during installation, select the “Help” menu, choose the “Help” buttons when boxes appear, or press <F1>.

To move back to a previous dialog box during installation, choose the “Cancel” button.

Prerequisites



- Make sure you have the necessary hardware, software and memory requirements to install NetWare Server for OS/2 and NetWare 4.11. See “Necessary Resources” on page 143.

- ❑ If your OS/2 computer will be used as a NetWare Server for OS/2 and a NetWare Client for OS/2 sharing one network board, you need to install the client software before installing the server. (If you have not installed the client, the installation program will prompt you).
- ❑ Install at least one network board (if you are sharing the network board between the client and server) and cabling according to manufacturer instructions. Note the network board settings such as interrupt, I/O, DMA, etc. (You enter these settings during installation.)
- ❑ Install OS/2 version 2.1 (or later) on your computer and leave at least 80 MB of free disk space for NetWare. (80 MB is the absolute minimum needed to install NetWare. If you want to store files and applications on the server, you will need to leave more free space for NetWare.)



If OS/2 is already installed on your computer, you may need to use the OS/2 FDISK utility to delete a current partition and create free disk space. For more information, see the OS/2 documentation about FDISK.

Using FDISK to create free space could destroy data on your hard disk. Be sure to back up files before using FDISK.

Choose an Installation Medium

You can install NetWare Server for OS/2 either from CD-ROM or from an existing NetWare server from a remote network installation area.

There are advantages and disadvantages to each:

- ◆ **Remote network.** This is the fastest installation option. It requires that you have a CD-ROM mounted as a NetWare volume, or that you have another NetWare 4 server.
- ◆ **CD-ROM.** This option is not as fast as installing from the network. It requires a CD-ROM drive installed as an OS/2 device on the computer on which you want to install NetWare Server for OS/2.

The following procedures explain how to install from each medium.

Install from CD-ROM

Make sure you have installed a SCSI board in your OS/2 computer and have connected a CD-ROM drive to it. (See your CD-ROM documentation for information about installing the CD-ROM drive and the corresponding drivers.)

Procedure

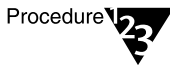

1. Insert the *NetWare 4.11 Operating System CD-ROM* into the CD-ROM drive.
2. Open an OS/2 window or full screen session.
3. Change to the drive corresponding to the CD-ROM.

If you are unsure which drive corresponds to the CD-ROM, choose the “OS/2 System” icon; then choose the “Drives” icon from the “OS/2 System Icon View” window.

A list of OS/2 drives and their corresponding devices appears. The CD-ROM drive corresponds to the “CD-ROM” icon.

4. Type

`INSTALL <Enter>`

A dialog box similar to the one shown in “Choose a Language to Install” on page 146 will appear.

Figure 4-1
Choose a Language
to Install



5. Choose the language you want to install and press <Enter>.

6. Go to “Determine Which Installation Option to Use” on page 152.

Install from a Remote Network Installation Area

A NetWare 4.11 Server for OS/2 can be installed over the network from either a mounted CD-ROM NetWare volume or another NetWare 4 server.

In either scenario, an OS/2 workstation running NetWare client software logs in to a remote area server and becomes a NetWare Server for OS/2 through the installation utility.

Requirements and recommendations for a remote installation are outlined below.

Requirements for a Network Installation Area

- ◆ The server with the CD-ROM image should not be RIP-filtered from the server being installed.
- ◆ The server being installed should use an IPX internal network number that is not RIP-filtered from the server with the CD-ROM image.



When installing using the “Simplified NetWare Server for OS/2” option, a randomly generated IPX internal network number is chosen for you. If you need to enter a specific IPX internal network number, you should install using the “NetWare Server for OS/2” option.

- ◆ If you are installing from a NetWare 4 server, the NDS User object you log in as must be in the same container as the Server object.

Recommendations for a Network Installation Area

- ◆ For better performance, the server with the CD-ROM image should have Packet Burst™ support. NetWare 3.12 and NetWare 4 servers have Packet Burst support built in. NetWare 3.11 requires PBURST.NLM for Packet Burst support.
- ◆ For better performance, the server with the CD-ROM image should have LIP (Large Internet Packet) support enabled.

NetWare 3.12 and NetWare 4 servers have LIP support enabled by default (using the SET command “Allow LIP = On”). NetWare 3.11 requires LIPX.NLM for LIP support.

Remote Installation Areas

The remote installation area can consist of one of the following:

- ◆ The *NetWare 4.11 Operating System* CD-ROM mounted as a NetWare volume.
- ◆ The *NetWare 4.11 Operating System* CD-ROM files copied to a volume on a NetWare 4 server.

If you want to	Go to
Install from the <i>NetWare 4.11 Operating System</i> CD-ROM mounted as a NetWare volume	“Install from a CD-ROM Mounted as a NetWare Volume” on page 148.
Install from the NetWare server volume containing copied <i>NetWare 4.11 Operating System</i> CD-ROM files	“Install from a NetWare Volume with Files Copied on a Server” on page 151.

Install from a CD-ROM Mounted as a NetWare Volume



Necessary Resources

- A CD-ROM drive that can read ISO 9660 formatted CD-ROM disks.
- An existing NetWare 4.11 server. (This will be the host server.)
- An existing NetWare workstation. (This will be the new server you install.)

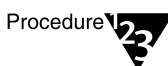

Procedure

1. **Cable the CD-ROM drive to the NetWare 4 server.**

Since you are installing the CD-ROM as a NetWare volume, you do not need to install any drivers at this time.

2. Insert the *NetWare 4.11 Operating System* CD-ROM into the CD-ROM drive.

3. At the C:\NWSERVER directory, type

```
NWOS2 <Enter>
```

4. At the server console, type

```
LOAD INSTALL <Enter>
```

The following menu appears.

Figure 4-2
The “Installation Options” Menu

Installation Options	
Driver options	(load/unload disk and network drivers)
Disk options	(configure/mirror/test disk partitions)
Volume options	(configure/mount/dismount volumes)
License option	(install the server license)
Copy files option	(install NetWare system files)
Directory options	(install NetWare Directory Services)
NCF files options	(create/edit server startup files)
Multi CPU options	(install/uninstall SMP)
Product options	(other optional installation items)
Exit	

5. Choose “Driver Options.”

The “Driver Options” menu appears.

6. Choose “Configure Disk and Storage Device Drivers.”

The “Additional Driver Actions” menu appears.

7. Choose “Select an Additional Driver.”

The “Select a Driver” list appears.

8. Choose the necessary CD-ROM drivers according to the documentation that accompanied your CD-ROM drive.



If the device drivers you need are not listed, press <Ins> and follow the prompts to access a new list of drivers.

Load CDROMSHR.DSK if you want the CD-ROM drive to be shared by OS/2 and NetWare Server for OS/2. CDROMSHR.DSK allows NetWare to access CD-ROM devices operating under OS/2. CDROMSHR.DSK is the interface from NetWare to OS/2 and OS/2 is the interface to the CD-ROM drive.

9. **Once you have loaded all necessary drivers, from the “Additional Driver Actions” menu choose “Return to Previous Menu.”**
10. **Press <Alt>+<F10> and choose “Yes” to exit INSTALL.NLM.**
You are returned to the server console.
11. **At the console prompt, type the following commands:**

```
LOAD NWPA <Enter>  
LOAD CDROM <Enter>  
CD MOUNT NW411 <Enter>
```
12. **Go to the OS/2 workstation on which you want to load NetWare Server for OS/2 and log in to the host server with the mounted CD-ROM NetWare volume.**
13. **Map a drive to the CD-ROM.**
14. **On the CD-ROM drive, type**

```
INSTALL <Enter>
```

A dialog box allowing you to choose the language you want to install appears (see Figure 4-1 on page 146).
15. **Choose the language you want to install and press <Enter>.**
16. **Go to “Determine Which Installation Option to Use” on page 152.**

Install from a NetWare Volume with Files Copied on a Server

Checklist



Necessary Resources

- An existing NetWare server with sufficient disk space (at least 170 MB) to store the NetWare 4.11 operating system files. (This will be the host server.)
- An existing OS/2 workstation with the NetWare Client for OS/2 installed on it. (This will be the new NetWare Server for OS/2.)
- (Conditional) A CD-ROM drive that can read ISO 9660 formatted CD-ROMs.

This is used to copy the NetWare 4.11 files from the CD-ROM to the host server.

Procedure

Procedure



1. **Create a NETWARE directory on an existing server and copy the files from the installation medium to that directory.**

For example, to copy from CD-ROM drive D: to network drive K:, type

```
K: <Enter>
MD NETWARE <Enter>
CD NETWARE <Enter>
NCPY D: /S /E /V <Enter>
```

2. **Install NetWare Client for OS/2 on each computer you want to be a NetWare Server for OS/2.**

If the client software is not installed, you cannot connect to the host server. For instructions on installing client software, see "Install NetWare Client for OS/2" on page 173.

3. **On every computer you want to make a NetWare Server for OS/2, map a drive to the network server directory that contains the NetWare 4.11 files.**
4. **Change to the drive corresponding to the server where you copied the installation files.**

5. Type

INSTALL <Enter>

A dialog box allowing you to choose the language you want to install appears (see Figure 4-1 on page 146).

6. Choose the language you want to install and press <Enter>.

7. Go to "Determine Which Installation Option to Use" on page 152.

Determine Which Installation Option to Use

After you choose the language you want to install, the installation utility appears.

Figure 4-3
NetWare for OS/2 Installation Utility

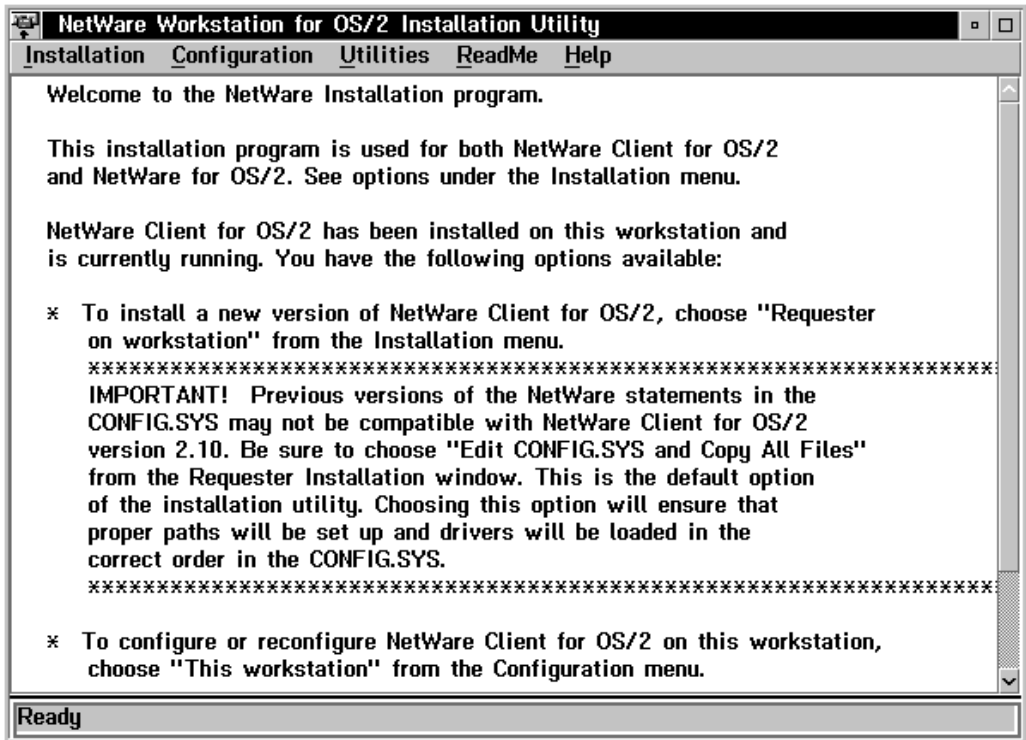

This utility is used for installing NetWare Server for OS/2 and NetWare Client for OS/2.

The main screen includes help information. For example, if NetWare Client for OS/2 is not running on your computer, a help message indicates possible reasons. The help message also indicates how to begin the installation.

There are three options for installing. Use the table below to determine which option to use.

If you want to	Go to
Install a new custom NetWare Server for OS/2	"Install Using the NetWare Server for OS/2 Option" on page 156.
Install a new simplified NetWare Server for OS/2 using defaults the system chooses for you	"Install Using Simplified NetWare Server for OS/2 Option" on page 153.
Upgrade an existing NetWare Server for OS/2 to a newer version	"Upgrade NetWare Server for OS/2" on page 181.

Install Using Simplified NetWare Server for OS/2 Option

The "Simplified NetWare Server for OS/2" option is designed to make installation of NetWare Server for OS/2 easier. When you use this option, it makes certain assumptions about your setup that may or may not be acceptable.

Assumptions Made by the Simplified Option



The "Simplified NetWare Server for OS/2" option assumes

- NetWare Server for OS/2 and NetWare Client for OS/2 are running on the same computer.
- NetWare Client for OS/2 and NetWare Server for OS/2 share a network board.
- Default selections for network board sharing.

- Only IPX/SPX communication protocols with TCP/IP support (no IBM* communication protocols) will be used on the network.
- Randomly generated IPX internal network numbers and other server information defaults are acceptable.
- The hard disk will not be mirrored or duplexed.
- One NetWare volume per disk.
- Automatic update of the CONFIG.SYS, NET.CFG, AUTOEXEC.NCF, and STARTUP.NCF files.
- A default Novell Directory Services hierarchy. The Simplified Installation (in NetWare 4.11) assumes a single container for all objects.

Prerequisites



- Determine whether this computer will be a
 - ◆ NetWare Server for OS/2 and NetWare Client for OS/2 sharing a network board.
 - ◆ NetWare Server for OS/2 and NetWare Client for OS/2 using more than one network board for the server and client.
 - ◆ NetWare Server for OS/2 only (using no client software).
- (Conditional) If you are sharing a network board, you must install NetWare Client for OS/2 before installing NetWare Server for OS/2.

For information on installing the client software, see “Install NetWare Client for OS/2” on page 173.

For more detailed information about installing and configuring the client software, see *IntranetWare Client for OS/2 User Guide*.

Procedure

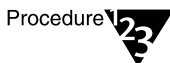

1. **From the “Installation” pull-down menu, choose “Simplified NetWare Server for OS/2.”**

The following dialog box appears.

Figure 4-4
NetWare Server for
OS/2 Installation



This dialog box allows you to verify the target directories where the server and driver files will be copied. The target directories are \NETWARE for driver files and \NWSERVER for server files on your OS/2 boot drive.

2. **Choose “Copy” to copy the server and driver files to the target directories.**

The bar at the bottom of the installation utility indicates which files are being copied. After several minutes, an “Installation Message” appears indicating that the files have been copied.

3. **Choose “OK” to continue the installation.**

The “Server Information” dialog box appears (see Figure 4-5).

Figure 4-5
The “Server
Information” Dialog
Box

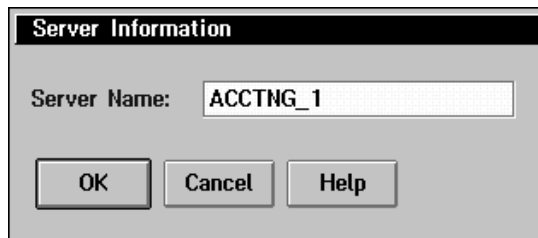

4. **Type the server name in the box provided and record the name for future reference.**

When the NetWare operating system (SERVER.EXE) loads, it reads this name.

5. **Choose “OK” to accept the server name.**

The installation utility main screen appears with a message indicating that you have completed the first part of the NetWare

for OS/2 installation. The second part consists of installing NetWare 4.11.

- 6. Exit the installation program by double-clicking on the small icon in the upper-left corner of the installation utility main screen.**

A message appears indicating that you need to reboot the computer so the changes made to the CONFIG.SYS and NET.CFG files will take effect.

- 7. Choose “OK” to close the message.**

- 8. Use the OS/2 shutdown feature to reboot your computer.**

Click the right mouse button on the desktop and select “Shut Down” from the menu that appears.

When the computer reboots, the second part of the installation (installing NetWare 4.11) starts automatically.

- 9. Go to “Choose the Server Drivers” on page 167.**

Install Using the NetWare Server for OS/2 Option



Prerequisites

- Determine whether this computer will be a
 - ◆ NetWare Server for OS/2 and NetWare Client for OS/2 sharing a network board.
 - ◆ NetWare Server for OS/2 and NetWare Client for OS/2 using more than one network board for the server and client.
 - ◆ NetWare Server for OS/2 only (no client software).
- (Conditional) If you are sharing a network board, you must install NetWare Client for OS/2 before installing NetWare Server for OS/2.

For information on installing the client software, see “Install NetWare Client for OS/2” on page 173.

For more detailed information about installing and configuring the client software, see *IntranetWare Client for OS/2 User Guide*.

Procedure

1. From the “Installation” pull-down menu, choose “NetWare Server for OS/2.”

If NetWare Client for OS/2 is installed and running on your computer, the following dialog box appears.

**Figure 4-6
Target Directories
for Server Files**



This dialog box allows you to verify the target directories where the server and driver files will be copied. The target directories are \NETWARE for driver files and \NWSERVER for server files on your OS/2 boot drive.

Note 

If NetWare Client for OS/2 is not installed, a message appears indicating that if you are sharing a network board, you must install the client software before installing NetWare Server for OS/2.

If you need to install the client software, choose “OK” and go to “Install NetWare Client for OS/2” on page 173.

2. Choose “Copy” to copy the server and driver files to the target directories.

The bar at the bottom of the installation utility indicates which files are being copied. After several minutes, a message appears indicating that the files have been copied (see Figure 4-7).

**Figure 4-7
System Message**

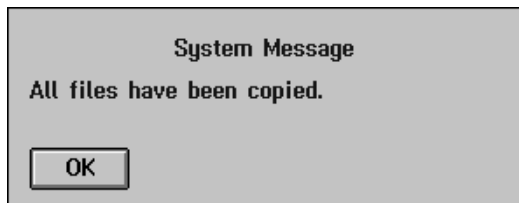

3. Choose “OK” to continue the installation.

The following message appears (see Figure 4-8).

Figure 4-8
Sharing a Network Board Between the Client and Server

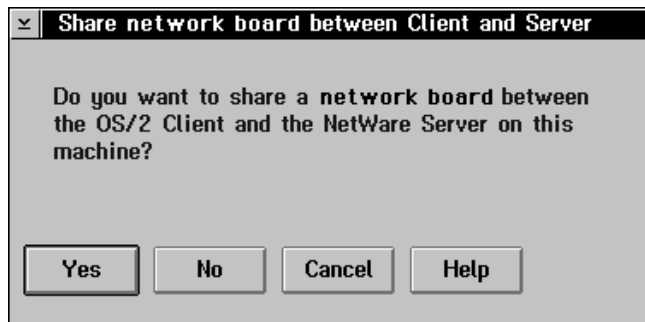

Use the decision table below to determine how to answer the message.

If the client and server	Then
Will share the same network board (the client and server are on the same computer)	Choose "Yes." The "Network Board Sharing Options" dialog box appears. Continue with the next section, "Sharing a Network Board."
Will not share the same network board.	Choose "No." The "Save Changes to CONFIG.SYS" dialog box appears. Choose "OK" to save changes to the CONFIG.SYS file. Go to "Enter Installation Information" on page 164.

Sharing a Network Board

If you answered Yes to sharing a network board between the client and server, the "Network Board Sharing Options" dialog box appears (see Figure 4-9).

Figure 4-9
**Network Board
 Sharing Options**

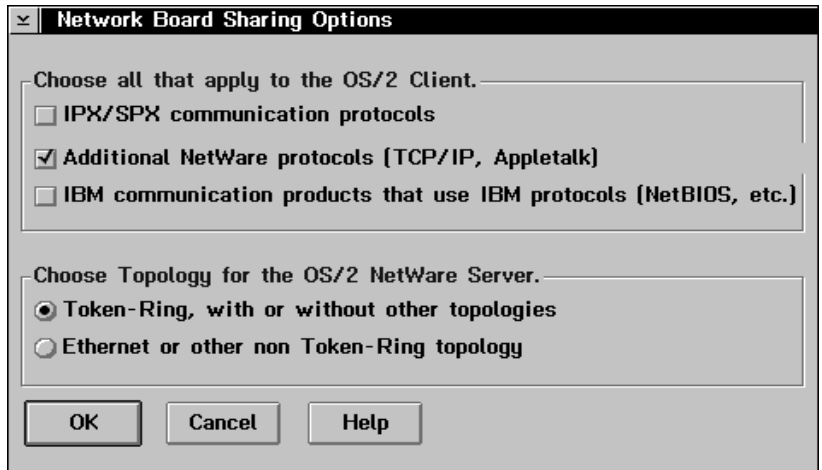

Procedure

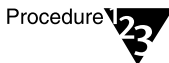

1. **Select the options in the “Network Board Sharing Options” dialog box that apply to your NetWare Server for OS/2 setup.**

The “Additional NetWare Protocols” and “Token Ring, With or Without Other Topologies” options are selected as defaults.

Use the decision box below to determine if you need to select options other than the defaults.

If your computer is sharing a network board using	Choose
Other NetWare protocols in addition to IPX/SPX (TCP/IP, AppleTalk*, etc.)	“Additional NetWare Protocols” and “Token Ring With or Without Other Topologies.” TOKENSHR.LAN will be loaded for you in the NetWare 4.11 installation. Continue with Step 2 below.

If your computer is sharing a network board using	Choose
IBM communication protocols	<p data-bbox="866 255 1249 338">"IBM Communication Products that Use IBM Protocols" and "Token Ring With or Without Other Topologies."</p> <p data-bbox="866 365 1249 421">TOKENLNK.LAN will be loaded for you in the NetWare 4.11 installation.</p> <p data-bbox="866 449 1249 587">This option requires that you are on a token ring network, that you have a token ring network board installed in your computer, and that you set up ODINSUP.</p> <p data-bbox="866 615 1162 637">Continue with Step 2 below.</p>
IPX/SPX protocols only	<p data-bbox="866 670 1249 753">"IPX/SPX Communication Protocols" and "Ethernet or Other Non-Token Ring Topology."</p> <p data-bbox="866 781 1249 837">LANSHARE.LAN will be loaded for you in the NetWare 4.11 installation.</p> <p data-bbox="866 864 1162 887">Continue with Step 2 below.</p>

2. Choose "OK" to continue the installation.

The "Save Changes to CONFIG.SYS" dialog box appears.

Figure 4-10
Save Changes to
CONFIG.SYS

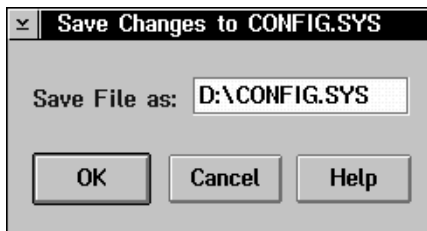

If you want to save the changes to another file, you can enter the path in this box. You would then need to update changes to the CONFIG.SYS file manually.

Several lines are added to the CONFIG.SYS file based on the options you selected in the "Network Board Sharing Options" dialog box (in Step 1). This dialog box confirms the location of your CONFIG.SYS file.

3. Choose “OK” to save the changes to the CONFIG.SYS file.

One of two different dialog boxes will appear depending on the choices you made in the “Network Board Sharing Options” dialog box (in Step 1).

If you chose	Then
“IBM Communication Products that use IBM Protocols”	A message appears indicating that you need to set up ODINSUP. Choose “Yes” and continue with the next section, “Set Up ODINSUP for Network Board Sharing.”
Any other option	The “Enter Installation Information” box appears (see Figure 4-13). Continue with “Enter Installation Information” on page 164.

Set Up ODINSUP for Network Board Sharing

The “ODINSUP Configuration Files” box appears (see Figure 4-11).

Figure 4-11
ODINSUP
Configuration Files

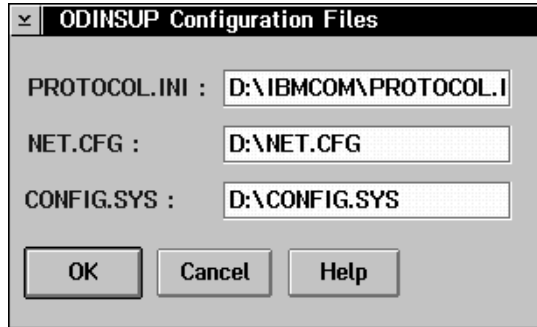

OS/2 and IBM communication programs, such as Extended Services and LAN Services, use protocol drivers and network drivers written to the NDIS specification.

NetWare Server for OS/2 and NetWare Client for OS/2 use protocol drivers and network drivers written to the ODI™ (Open Data-link Interface™) specification.

The ODINSUP setup provides a way for NetWare products and IBM products to share a network board, by replacing the NDIS driver with a driver called ODINSUP.SYS.

The “ODINSUP Configuration Files” dialog box displays the location of the PROTOCOL.INI, NET.CFG, and CONFIG.SYS files. These files are edited during ODINSUP setup.

If the location of the configuration files as they appear in this box is incorrect, type the correct path in the box next to each filename.



For more information about sharing network boards and setting up ODINSUP, see *IntranetWare Client for OS/2 User Guide* and “ODINSUP” in *Concepts*.

Procedure

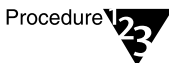

1. **Choose “OK” to continue the installation.**

The following dialog box appears.

Figure 4-12
ODINSUP Setup Box

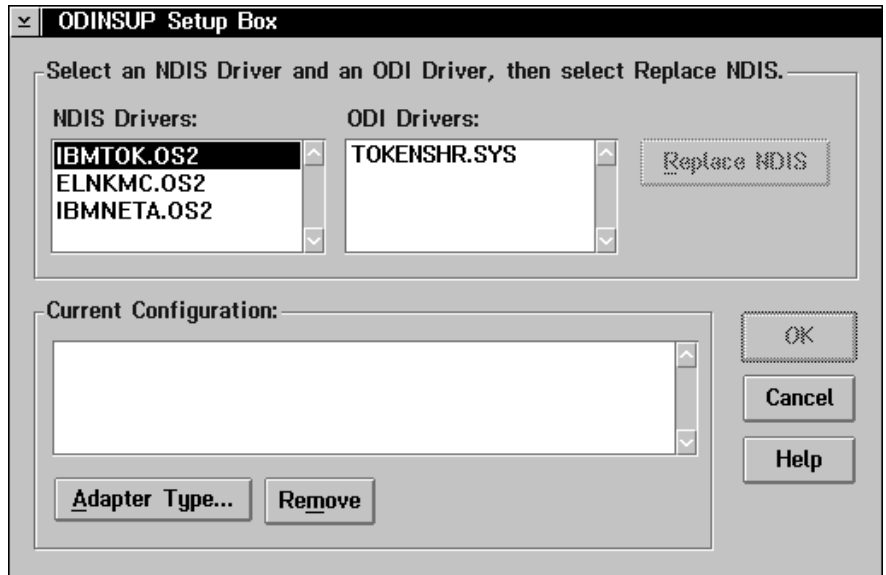

2. **Select the NDIS driver and the ODI driver you want to replace it with from the lists in the “ODINSUP Setup Box.”**

If you do not know which NDIS driver to select, check the documentation for the IBM program you are using.

The “Replace NDIS” button is not active until a driver from each list is selected.

3. **Choose “Replace NDIS.”**

The drivers you select are displayed in the “Current Configuration” field with a message indicating that the ODI driver is replacing the NDIS driver.

If you select the wrong NDIS or ODI driver to be replaced, choose “Remove” to remove the selected drivers from the “Current Configuration” field.

4. **Repeat Step 2 and Step 3 for each NDIS driver you want replaced by an ODI driver.**

5. Choose “OK” to replace the NDIS drivers with the ODI drivers you selected.

ODINSUP is set up and your NET.CFG, CONFIG.SYS, and PROTOCOL.INI files are edited for you.



For more detailed information about setting up ODINSUP, and editing the NET.CFG and CONFIG.SYS files, see “Using ODINSUP” in *IntranetWare Client for OS/2 User Guide*.

6. Continue with “Enter Installation Information” below.

Enter Installation Information

The “Enter Installation Information” box appears (see Figure 4-13).

Figure 4-13
Enter Installation
Information

Enter Installation Information

Server Information

Server Name: ACCTNG_1

IPX Internal Network Number: 2D2A060

Locale:

Country Code: 001 (United States)

Code Page: 437 (United States English)

Keyboard Mapping: None

File Format

DOS filename format (recommended)

NetWare filename format

OK Cancel Help

To move among the fields in the “Enter Server Information” dialog box, press <Tab> or use the mouse.

Procedure

Procedure



1. In the “Server Name” field, type the server name in the box provided and record the name for future reference.

When the NetWare operating system (SERVER.EXE) loads, it reads this server name.

2. In the “IPX Internal Network Number” field, accept the randomly generated number, or assign a new IPX number to this server.

The IPX internal network number is a logical network number that identifies an individual NetWare 4 server. Each server on a network must have a unique IPX internal network number.

If your NetWare Server for OS/2 is on a small network, the randomly generated number is probably sufficient, because there is low probability that it will be repeated.

Whether you accept the random number or enter your own, you should record the number for future reference.

Note



For more information about IPX internal network numbers, see “Network numbering” in *Concepts*.

3. (Optional) Verify the country code, code page, and keyboard information for your server.

For information on the country code, code page, or keyboard mapping, see your OS/2 manual.

For a brief explanation, choose “Help” or press <F1>.

4. (Optional) Select a filename format.

The “DOS Filename Format” is selected as a default and is recommended. This filename format limits you to using valid DOS filename characters according to the country code and code page selections.

Limiting the server to valid DOS filename characters prevents workstations using NETX shells from creating files using nonstandard DOS filename characters.

Selecting “NetWare Filename Format” allows you to use NetWare-acceptable characters that may or may not be valid DOS characters.

5. Choose “OK” to accept the settings in the “Enter Installation Information” box.

The installation main screen appears again with a message indicating that you have completed the first part of the NetWare Server for OS/2 installation. The second part consists of installing NetWare 4.11.

6. Exit the installation program by double-clicking on the small icon in the upper-left corner of the main screen.

A message appears:

Figure 4-14
Reboot the
Computer

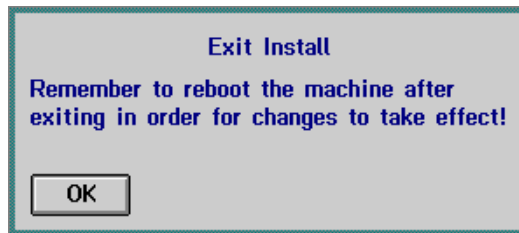

7. Choose “OK.”
8. Use the OS/2 shutdown feature to reboot your computer.

Click the right mouse button on the desktop and select “Shut Down” from the menu that appears.

When the computer reboots, the second part of the installation (installing NetWare 4.11) will start automatically.

9. Continue with the next section, “Choose the Server Drivers.”

Choose the Server Drivers

After you reboot the computer, the server is brought up automatically and the NetWare 4.11 installation utility starts. A screen listing the available LAN drivers appears as shown in Figure 4-15.

If this screen does not appear after rebooting, open an OS/2 Window or Full Screen and change to the \NWSERVER directory. Then type

`NWINSTAL <Enter>`

This will bring up the server and start the NetWare 4.11 installation program.

Load a LAN Driver

When the NetWare 4.11 installation program starts, it scans for available disk and LAN drivers, and the following screen appears.

Figure 4-15
Available LAN Drivers

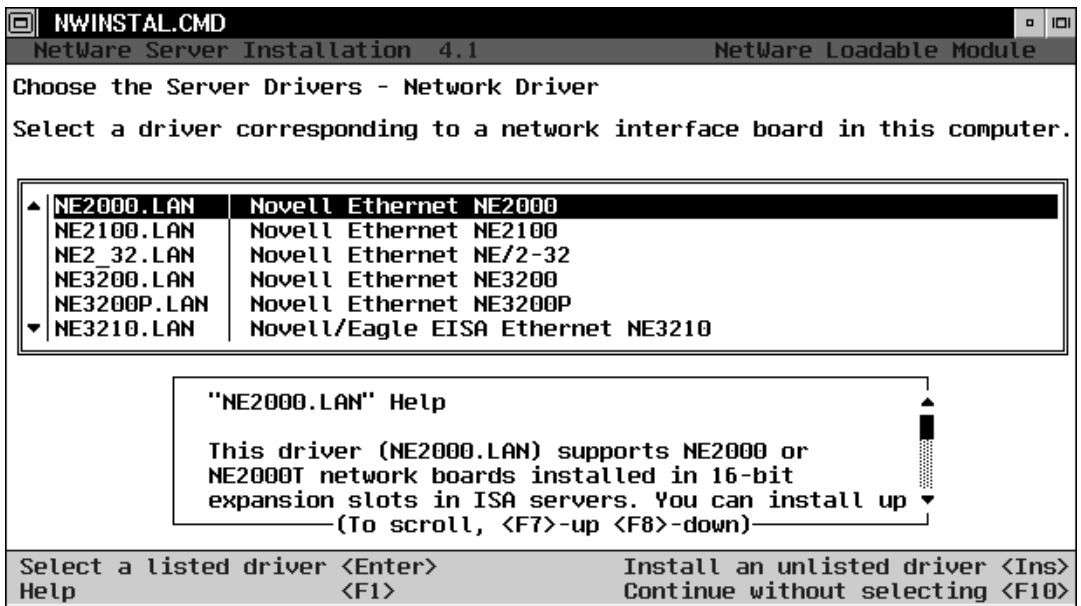

Procedure

- 1. Choose the driver corresponding to the network board installed in your computer.**

Use the Up- and Down-arrow keys to select the LAN driver. (The mouse does not function in the NetWare 4.11 installation program.)

If	Then
The driver is listed	Choose the appropriate LAN driver and press <Enter>. Continue with Step 2.
The driver is not listed	Press <Ins> and follow the prompts. Continue with Step 2.

If you chose the TOKENLNK network board sharing option (see “Sharing a Network Board” on page 158), you must have a token ring network board installed in your computer and you must load the token ring driver corresponding to it.

For a current list of network boards and drivers that work with TOKENLNK, see the README file included with the NetWare Server for OS/2 installation utility.

A screen similar to the one shown in Figure 4-16 below appears:

Figure 4-16
Network Driver Parameters

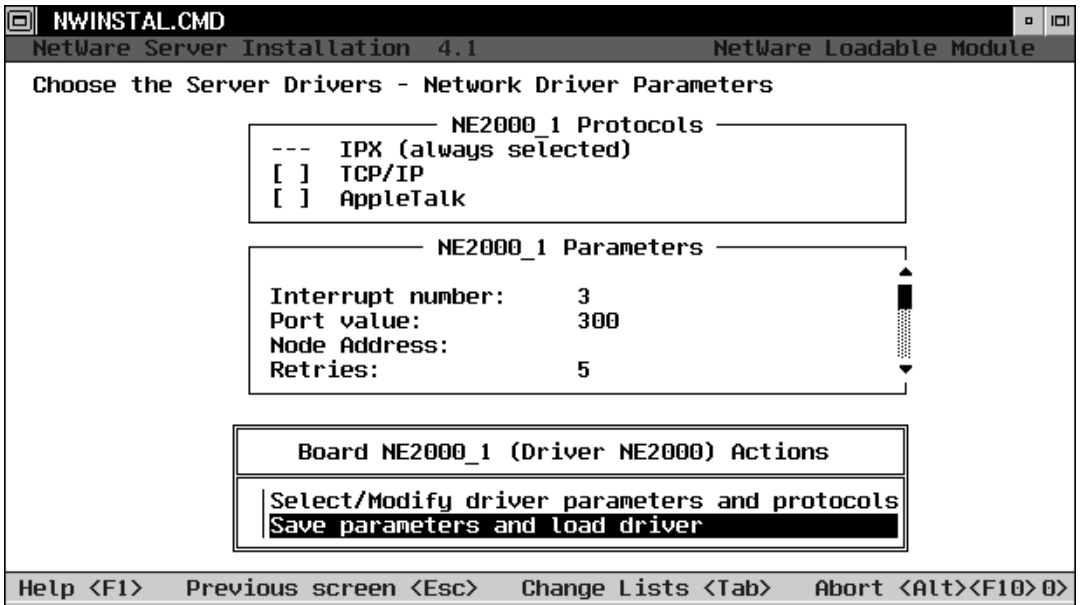

2. Verify that the driver parameters match the settings on the network board in your computer.

If the default values	Then
Are correct	Continue with Step 3.
Are incomplete or conflict with other hardware settings	Choose "Select/Modify Driver Parameters" and enter the parameters. Press <F10> or <Esc> to exit the screen and save your changes. Continue with Step 3.

If you chose the TOKENLNK network board sharing option, random ring numbers have been selected for you. If you need to enter specific ring numbers for your network board, choose "Select/Modify Driver Parameters" and enter the ring numbers.

3. Choose “Save Parameters and Load Driver” and press <Enter>.

A screen appears indicating that IPX will be bound to the driver you just selected.

4. Press <Enter> to continue.

A screen appears asking if you want to select another network driver.

5. Choose “No” and press <Enter>.

The following screen appears:

Figure 4-17
Choose the Server Drivers

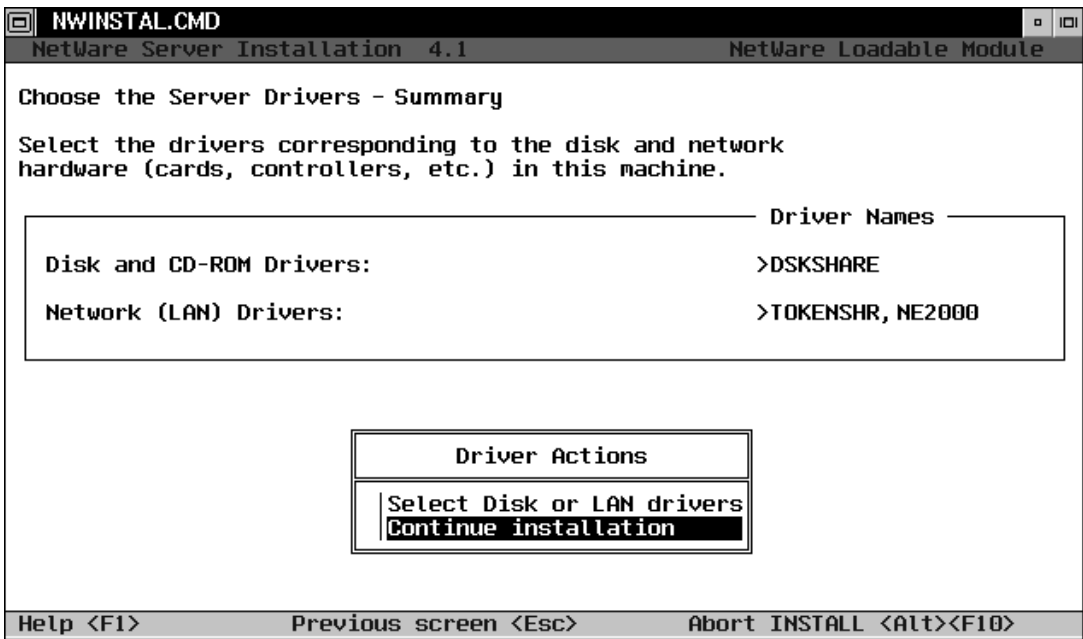

This screen indicates that the LAN driver you have just selected is currently loaded. This screen also displays the default disk and LAN drivers that were chosen for you to be loaded.

When the NetWare 4.11 installation utility started automatically, it scanned for available disk and LAN drivers (see “Choose the Server Drivers” on page 167).

DSKSHARE is always the default disk driver if your OS/2 and NetWare file systems share the same hard disk. DSKSHARE allows OS/2 and NetWare to use separate partitions on the same hard disk.

DSKSHARE is the interface to OS/2, and OS/2 is the interface to the driver for the hard drive.

If you install additional hard disks that are used only by NetWare, you will need to install additional NetWare disk drivers to handle those disks.

The default LAN driver chosen for you varies depending on the choices you made for sharing a network board (see “Sharing a Network Board” on page 158).

For example, if you chose “IBM Communication Products that Use IBM Protocols,” TOKENLNK is the chosen default driver.

If you chose “IPX/SPX Communication Protocols Only,” LANSHARE is the default driver.

If you accepted the default choices, TOKENSHR is the default driver.

The default driver must be loaded in addition to the LAN driver you loaded corresponding to the network board in your computer.

The default driver allows OS/2 and NetWare to share the same physical network board. The default driver is the interface from OS/2 to NetWare. The LAN driver you loaded in Step 1 is the interface from NetWare to the network board.

6. Choose “Continue Installation.”

The “Bind LAN Driver to IPX” screen appears as shown in Figure 4-18:

Figure 4-18
Bind LAN Driver to IPX

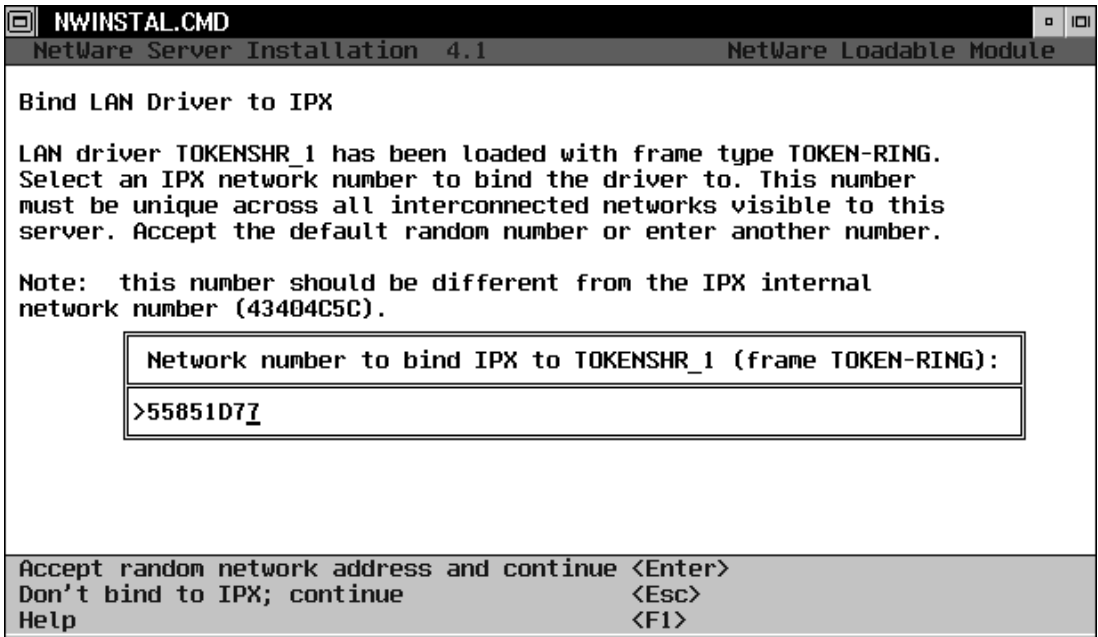

The LAN driver you selected corresponding to the network board in your computer has already been loaded and bound to IPX. The default LAN driver (LANSHARE or TOKENSHR) must also be bound to IPX.

Use this screen to assign an IPX external network number to the driver. The IPX external network number assigned to this driver must be unique and cannot match the IPX external network number that is bound to the other LAN driver you loaded.

You can accept the randomly generated IPX external network number or enter your own IPX external network number to be bound to the default driver.

Record this IPX external number for future reference.

For more information about the IPX external network number, see “Network numbering” in *Concepts*.

If you are using the TOKENLNK network board sharing option, your token ring driver and TOKENLNK will not be bound to IPX.

A message will appear indicating that the drivers have loaded successfully.

7. **Press <Enter> to accept the IPX external network number and continue with the installation.**
8. **Use the table below to determine where to go to continue the installation.**

If you installed the	Go to
"Simplified NetWare Server for OS/2" option	"Create the NetWare Disk Partition" on page 39 in the "Simple Installation" chapter.
"NetWare Server for OS/2" option	"Create NetWare Disk Partitions" on page 79. (Located in "Custom Installation" on page 59)

Install NetWare Client for OS/2

If NetWare Client for OS/2 is not installed or is not currently running on your computer and you attempt to install NetWare Server for OS/2, the following message appears.

Figure 4-19
Share network board

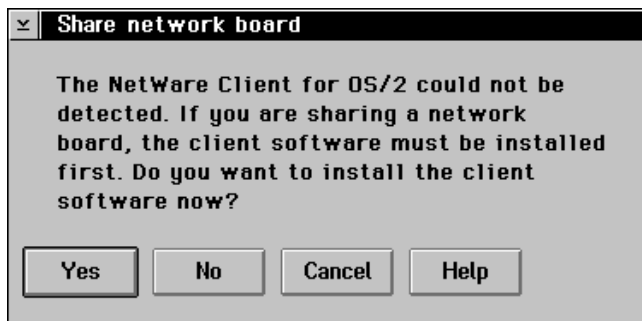

If you are sharing a network board between the client and server, you must install NetWare Client for OS/2.

If you answer "Yes," a "Set Target Directory" dialog box appears (see Figure 4-20).

Figure 4-20
Set Target Directory

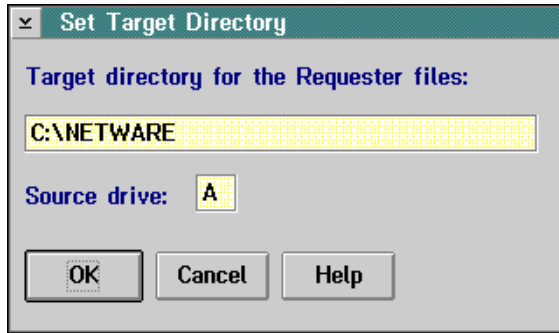

This dialog box allows you to verify the source drive that the client files will be copied from and the target directory that the files will be copied to.

For example, if you are installing from CD-ROM, the source drive is the drive associated with the CD-ROM reader and the target directory is \NETWARE on your OS/2 boot drive (for example, D:\NETWARE).

This section briefly explains how to install the client software. For a more detailed explanation, see *IntranetWare Client for OS/2 User Guide*.

Procedure

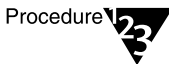

1. Choose "OK" in the "Set Target Directory" dialog box to confirm where the client files will be copied to.

The "Requester Installation" dialog box appears (see Figure 4-21).

Figure 4-21
Requester
Installation



The “Edit CONFIG.SYS and Copy All Files” option is selected as a default. You should use this default option if you are doing a complete client installation for the first time.

For information about the other options in this dialog box, either press <F1>, choose “Help,” or refer to *IntranetWare Client for OS/2 User Guide*.

2. Choose “OK” to copy the files to your target directory.

The “Choose the ODI LAN Driver” dialog box appears.

Figure 4-22
Choose the ODI
LAN Driver

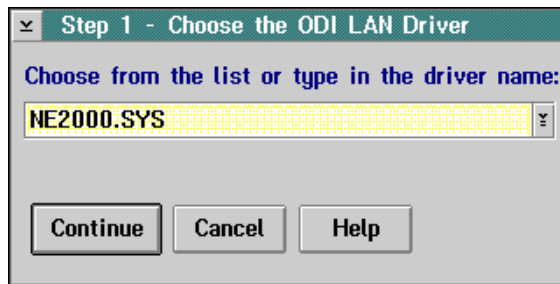

3. Choose the LAN driver for your computer.

You can type the name of the driver in the “Choose the ODI LAN Driver” dialog box or click on the scroll arrow and select the driver from the list.

4. Choose “Continue.”

The “Choose NetWare Support for DOS and Windows Applications” dialog box appears (see Figure 4-23).

Figure 4-23
Choose NetWare
Support for DOS
and Windows
Applications

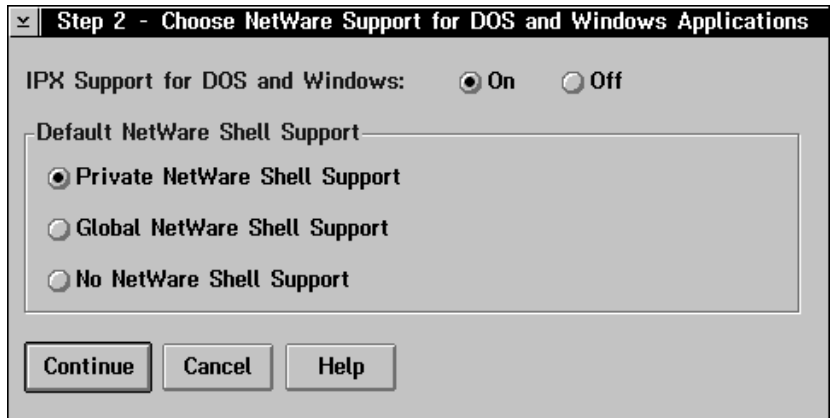

5. Turn on “IPX Support for DOS and Windows” and select one of the “Default NetWare Shell Support” options.

If “IPX Support for DOS and Windows” is turned off, you cannot access the NetWare network from DOS or MS Windows sessions.

For more information about the other options in this dialog box, either press <F1>, choose “Help,” or refer to *IntranetWare Client for OS/2 User Guide*.

6. Choose “Continue” to accept the options you selected.

The “Save Changes to AUTOEXEC.BAT” dialog box appears (see Figure 4-24).

Figure 4-24
Save Changes to
AUTOEXEC.BAT



If you selected “Private or Global NetWare Support” (in Step 5), make sure that “NETX.EXE” is selected. This causes NETX.EXE to be loaded automatically when you start a DOS or MS Windows session.

If you selected IPX/SPX support, you need to select “TBMI2.COM” if you are using any MS Windows applications that use TBMI2 to directly access the network (some E-mail packages may require TBMI2).

7. Choose “Save” to save the changes to the AUTOEXEC.BAT file and continue with the installation.

A message appears:

Figure 4-25
Installation
Message

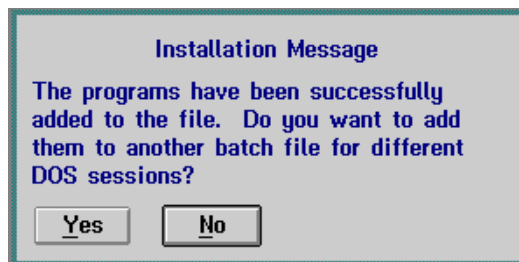

8. Choose “No” to continue with the installation.

For more information about adding NETX.EXE and TBMI2.COM to another batch file, see *IntranetWare Client for OS/2 User Guide*.

A message appears:

Figure 4-26
Set DOS
LASTDRIVE

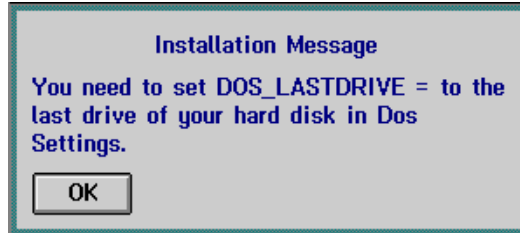

For example, if you have partitioned drives C:, D:, and E: on your hard disk, you would set DOS_LASTDRIVE=E.

For more information about entering settings for DOS sessions, see your OS/2 manual.

9. Choose "OK" to continue with the installation.

The "Choose Optional Protocols" dialog box appears.

Figure 4-27
Choose Optional
Protocols

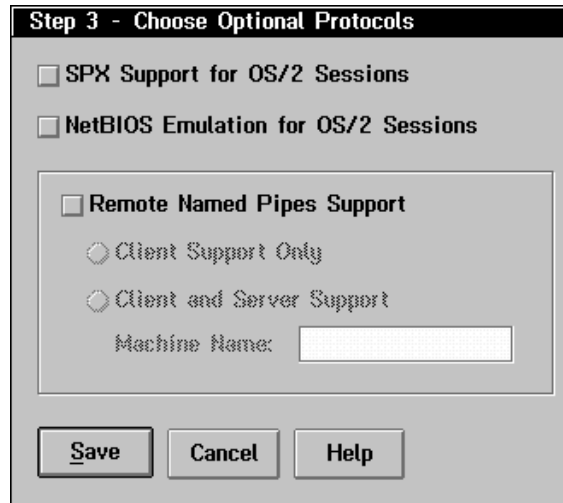

10. Choose the protocol support you want, then choose "Save."

For more information about protocol support, either press <F1>, choose "Help," or refer to *IntranetWare Client for OS/2 User Guide*.

The “Save Changes to CONFIG.SYS” dialog box appears.

Figure 4-28
Save Changes to
CONFIG.SYS

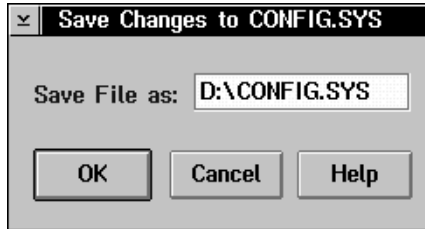

This dialog box displays the current location of your CONFIG.SYS file.

11. Choose “OK.”

The “Copy ODI LAN Driver Files” dialog box appears (see Figure 4-29).

Figure 4-29
Copy ODI LAN
Driver files



The option “Copy Only the Default Driver” is selected as a default. If you want to copy all available ODI drivers to your client directory, choose “Copy All the Drivers on the Disk.”

12. Choose “OK” to copy the driver files.

The driver files are copied to the target directory. The “Copy Requester Files” dialog box appears.

Figure 4-30
Copy Requester
Files

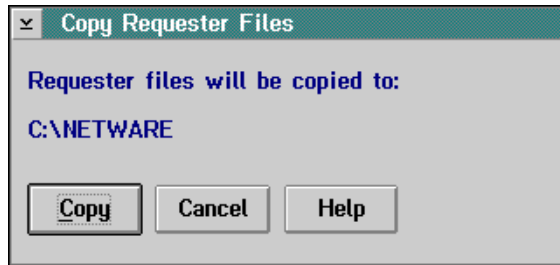

13. Choose “Copy” to copy the client files to the target directory shown in the “Copy Requester Files” box.
14. Follow the screen prompts to complete the NetWare Client for OS/2 installation.
15. Go to “Install Using the NetWare Server for OS/2 Option” on page 156.

Upgrade NetWare Server for OS/2

Use this installation option if you are upgrading from a NetWare 4.01 or 4.02 Server for OS/2 to a NetWare 4.11 Server for OS/2.

You can upgrade NetWare Server for OS/2 from CD-ROM, or from a remote server installation area that has the updated NetWare files copied onto it.

Upgrade from CD-ROM

Procedure

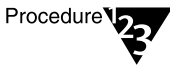

1. **Change to the CD-ROM drive and type**

`INSTALL` <Enter>

The installation utility appears. You do not need to down the server.

2. **From the “Installation” pull-down menu, choose “Upgrade NetWare Server for OS/2.”**

The “NetWare Server for OS/2 Installation” dialog box appears (see Figure 4-31).

Figure 4-31
NetWare Server for OS/2 Installation

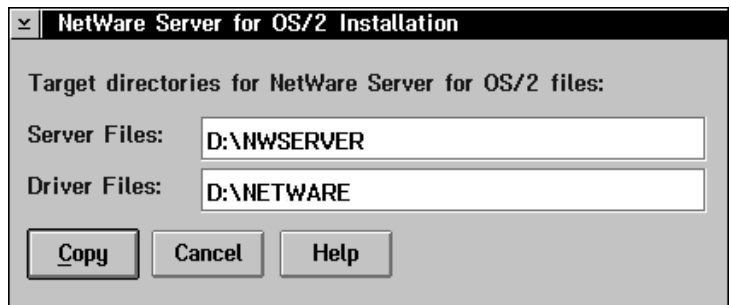

This dialog box allows you to verify the target directories that the server and driver files will be copied to. For example, the target directories are \NETWARE for driver files and \NWSERVER for server files on your OS/2 boot drive.

If you want to copy the files into directories other than the ones indicated, you can change the path and target directories in the boxes provided. However, the driver files *must* be copied to the

same directory that contains NetWare Client for OS/2 (the \NETWARE Directory).

3. **Choose “Copy” to copy the server and driver files to the target directories.**

The bar at the bottom of the installation utility indicates which files are being copied.

After the files are copied, a “Drivers Not Updated” box similar to Figure 4-34 may appear.

Figure 4-32
List of Drivers Not Upgraded



This is a list of drivers found in the destination path that were not updated. These drivers may or may not work with the updated version.

4. **Choose “OK” to continue the installation.**
5. **Exit the installation utility by double-clicking on the small icon in the upper-left corner of the main screen.**

A message appears indicating that you should reboot the computer so the changes you made to the CONFIG.SYS and NET.CFG files will take effect.

6. **Choose “OK.”**
7. **Down the server.**
8. **Use the OS/2 shutdown feature to reboot your computer.**

Click the right mouse button on the desktop and select “Shut Down” from the menu that appears.

When the computer reboots, the second part of the installation (installing NetWare 4.11) will start automatically.

9. Go to “Choose the Server Drivers” on page 167.

Upgrade from a Remote Server Installation Area

Procedure

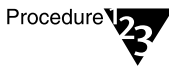

1. Open an OS/2 window or full screen session.
2. Map a drive to the server that has a copy of the NetWare 4.11 installation files.
3. Change to the drive you mapped in Step 2.
4. Change to the 4.11 subdirectory and type

```
INSTALL <Enter>
```

The installation utility appears.

5. From the “Installation” pull-down menu, choose “Upgrade NetWare Server for OS/2.”

The “NetWare Server for OS/2 Installation” dialog box appears (see Figure 4-31).

Figure 4-33
NetWare Server for
OS/2 Installation

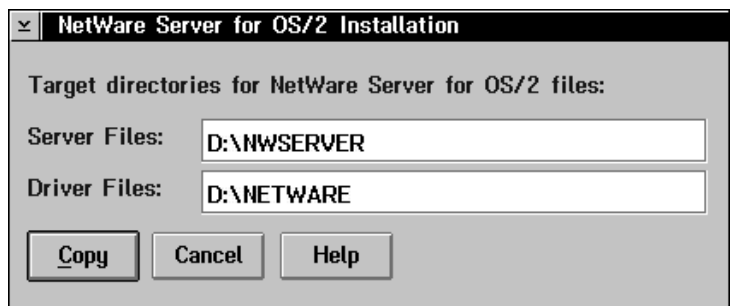

This dialog box allows you to verify the target directories that the server and driver files will be copied to. For example, the target

directories are \NETWARE for driver files and \NWSERVER for server files on your OS/2 boot drive.

If you want to copy the files into directories other than the ones indicated, you can change the path and target directories in the boxes provided. However, the driver files *must* be copied to the same directory that contains NetWare Client for OS/2 (the \NETWARE directory).

6. Choose “Copy” to copy the server and driver files to the target directories.

The bar at the bottom of the installation utility indicates which files are being copied.

After the files are copied, a “Drivers Not Updated” box similar to Figure 4-32 may appear.

Figure 4-34
List of Drivers Not Upgraded

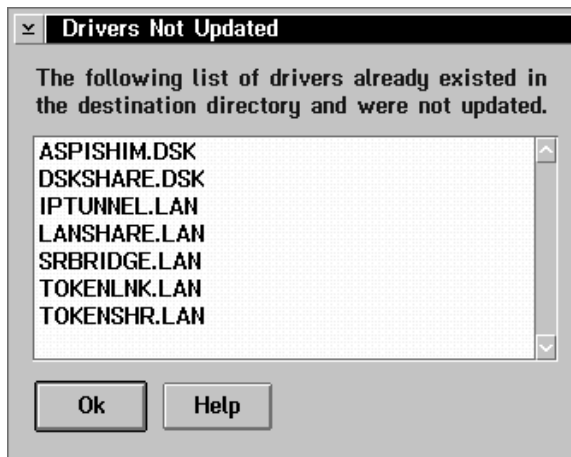

This is a list of drivers found in the destination path that were not updated. These drivers may or may not work with the updated version.

7. Choose “OK” to continue the installation.

8. Exit the installation utility by double-clicking on the small icon in the upper-left corner of the main screen.

A message appears:

Figure 4-35
Reboot Your
Computer

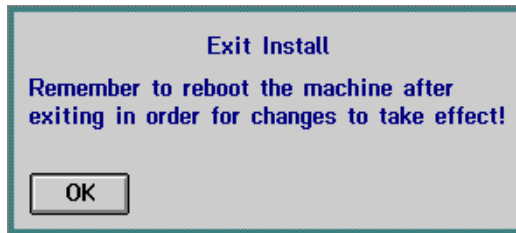

9. Choose “OK.”
10. Down the server.
11. Use the OS/2 shutdown feature to reboot your computer.

Click the right mouse button on the desktop and select “Shut Down” from the menu that appears.

When the computer reboots, the second part of the installation (installing NetWare 4.11) will start automatically.

12. Go to “Choose the Server Drivers” on page 167.

Changing Network Board Sharing Configurations

This section explains how to load and unload drivers for different network board sharing configurations after the server has been installed.

Changing from TOKENSHR to TOKENLNK

Procedure

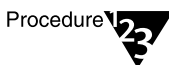

1. At the NetWare Server for OS/2 console, type

```
LOAD INSTALL <Enter>
```

The “Installation Options” menu as shown in Figure 4-36 appears:

Figure 4-36
Installation Options

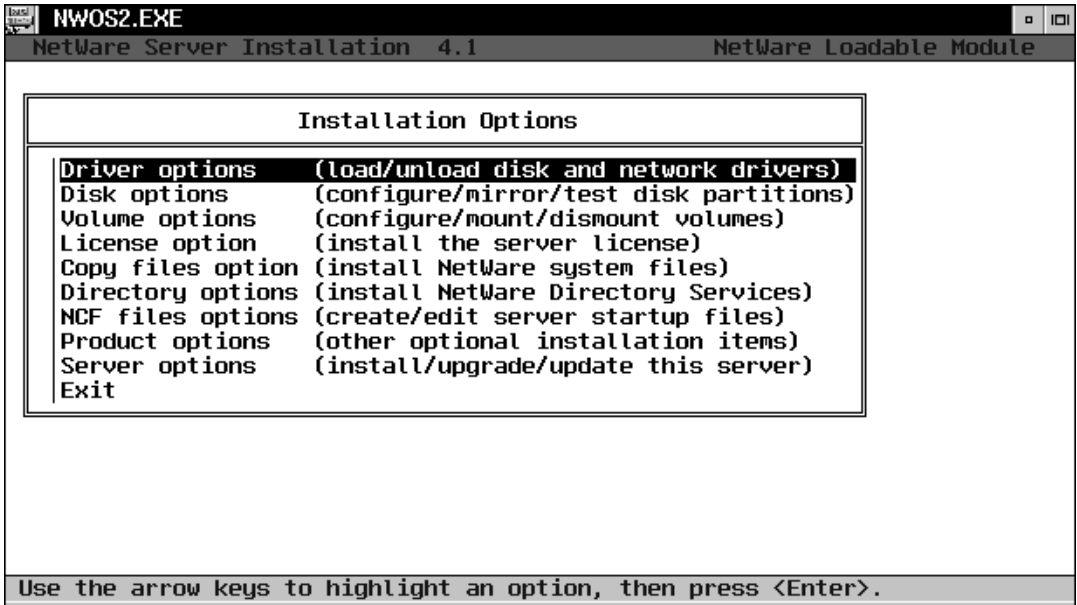

2. Choose "Driver Options."

The "Driver Options" menu appears as shown in Figure 4-37 below.

Figure 4-37
Driver Options

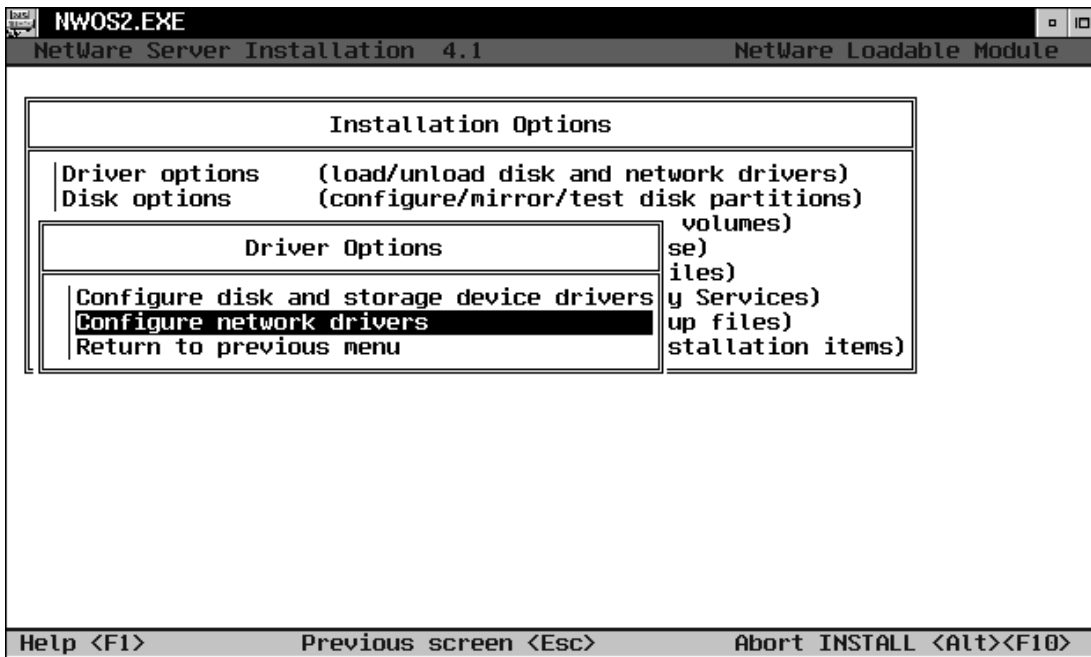

3. Choose "Configure Network Drivers."

The "Additional Driver Actions" menu appears as shown in Figure 4-38 below.

Figure 4-38
Additional Driver Actions

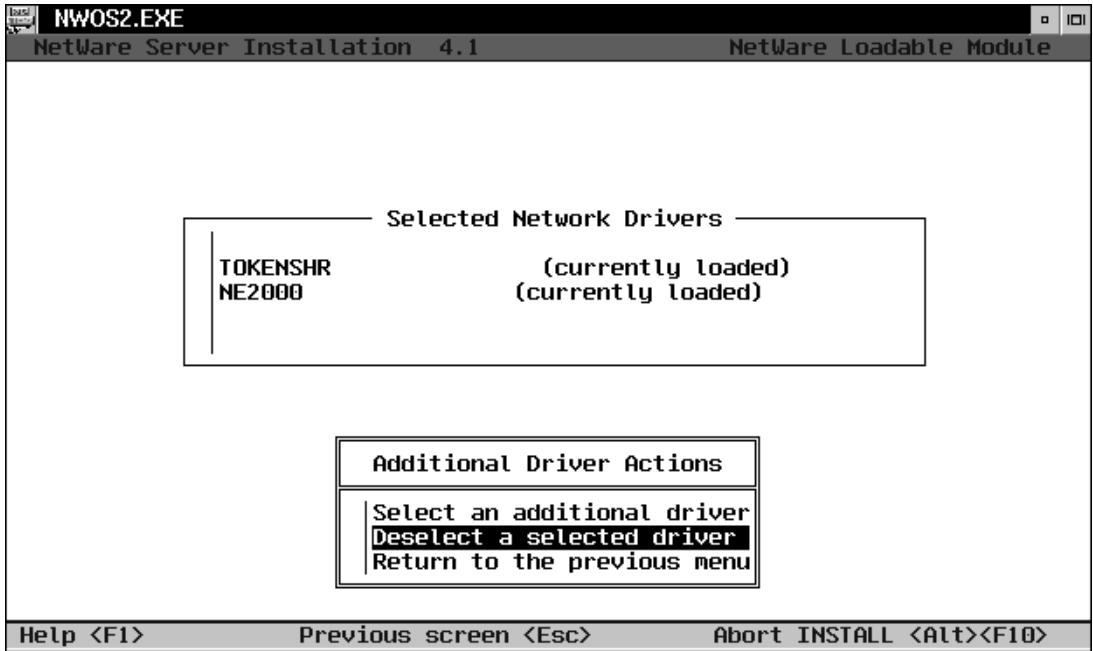

4. Choose "Deselect a Selected Driver."
5. Choose "TOKENSHR" from the "Selected Network Drivers" field.

Use the Up- and Down-arrow keys to select the driver.

6. Press <Enter> to unload the selected driver.

A message appears indicating that the selected driver has been successfully unloaded.

7. Press <Enter> to continue.

8. Choose "Select an Additional Driver" from the "Additional Driver Actions" menu.

A list of available drivers appears as shown in Figure 4-39 below.

Figure 4-39
List of Available Drivers

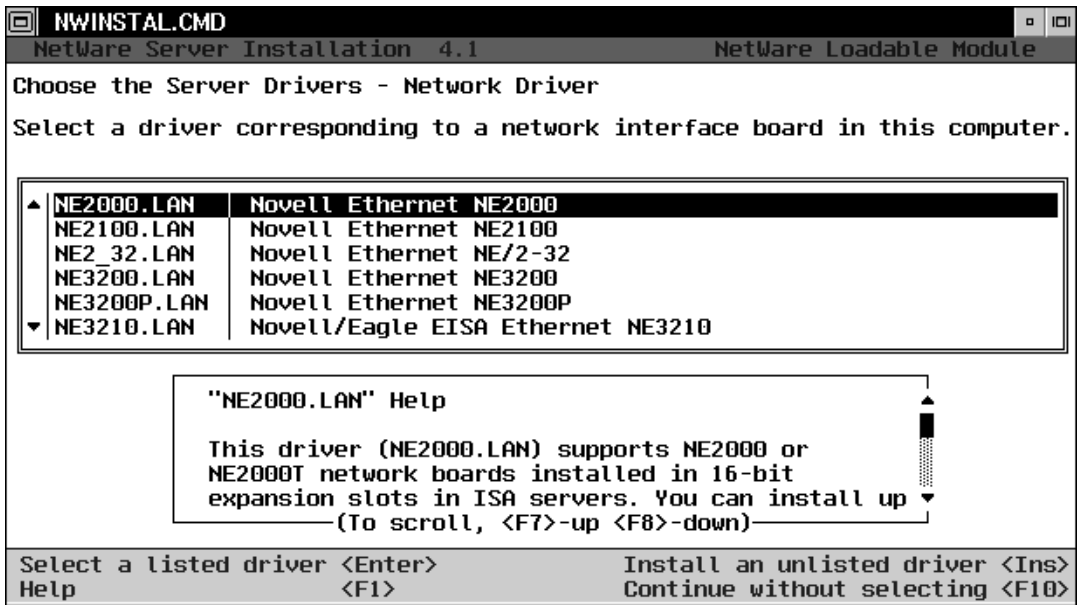

9. Select TOKENLNK.LAN from the list of available drivers.

A screen appears allowing you to verify the ring numbers for the selected driver.

10. Choose "Save Parameters" and load driver and press <Enter>.

A message appears indicating that the driver has been successfully loaded.

A message appears asking if you want to select an additional network driver.

11. Choose "No" and press <Enter>.

The "Additional Driver Actions" menu appears as shown in Figure 4-38 on page 188.

12. Choose "Return to the Previous Menu."

The “Driver Options” menu appears as shown in Figure 4-37 on page 187.

13. Choose “Return to Previous Menu.”

The “Installation Options” menu appears as shown in Figure 4-36 on page 186.

14. Choose “Exit” to exit the installation utility.

15. Bring down the server and reboot your computer so that the changes will take effect.

Changing from TOKENLNK to TOKENSHR

Procedure

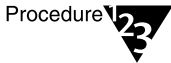

1. At the NetWare Server for OS/2 console, type

```
LOAD INSTALL <Enter>
```

The “Installation Options” menu appears as shown in Figure 4-36 on page 186.

2. Choose “Driver Options.”

The “Driver Options” menu appears as shown in Figure 4-37 on page 187.

3. Choose “Configure Network Drivers.”

The “Additional Driver Actions” menu appears as shown in Figure 4-38 on page 188.

4. Choose “Deselect a Selected Driver.”

5. Choose “SRBRIDGE” from the “Selected Network Drivers” field.

SRBRIDGE is the multiple protocol source routing bridge driver used with TOKENLNK.LAN. Use the Up- and Down-arrow keys to select the driver.

6. Press <Enter> to unload the selected driver.

A message appears indicating that the selected driver has been successfully unloaded.

7. Press <Enter> to continue.

8. Unload each token ring driver bound to SRBRIDGE.LAN.

Choose “Deselect a Selected Driver” from the “Additional Driver Actions” menu for each token ring driver.

The drivers need to be unloaded because they are bound to SRBRIDGE.LAN. (Because SRBRIDGE.LAN is unloaded, the drivers have nothing to be bound to.)

9. Choose “Select an Additional Driver” from the “Additional Driver Actions” menu.

A list of available drivers appears.

10. Select each token ring driver that you unloaded in Step 8.

The drivers need to be reloaded so they can be bound to IPX and TOKENSHR.LAN.

A screen appears allowing you to verify the parameters for the selected driver.

11. Choose “Save Parameters and Load Driver” and press <Enter>.

A screen appears allowing you to bind the driver to IPX.

12. Enter an IPX external network number for each token ring driver, or press <Enter> to accept the randomly generated IPX external network number.

For more information about the IPX external network number, see “Network numbering” in *Concepts*.

A message appears asking if you want to select an additional network driver.

13. Choose “Yes” to select an additional network driver.

14. Select TOKENSHR.LAN from the list of available drivers.

The “Parameter Actions” menu appears.

15. **Choose “Save Parameters and Load Driver.”**
16. **Enter an IPX external network number, or press <Enter> to accept the randomly generated IPX external network number.**

A message appears asking if you want to select an additional network driver.
17. **Choose “No.”**

The “Additional Driver Actions” menu appears as shown in Figure 4-38 on page 188.
18. **Choose “Return to the Previous Menu.”**

The “Driver Options” menu appears as shown in Figure 4-37 on page 187.
19. **Choose “Return to Previous Menu.”**

The “Installation Options” menu appears as shown in Figure 4-36 on page 186.
20. **Choose “Exit” to exit INSTALL.**
21. **Bring down the server and reboot your computer so that the changes will take effect.**

Changing from LANSHARE to TOKENSHR or TOKENLNK

Procedure

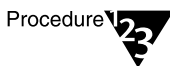

1. **Open the NET.CFG file in an OS/2 text editor by typing the following in an OS/2 window:**

```
EPM NET.CFG <Enter>
```

2. **Add the following lines to the NET.CFG file:**

```
LINK DRIVER drivername
      NODE ADDRESS address
```

Replace *drivername* with TOKENSHR or TOKENLNK, depending on the network board sharing option you are using. Replace *address* with a 12-byte node address.

3. Open the CONFIG.SYS file in an OS/2 text editor.

Replace the following line:

```
DEVICE=drive: \NETWARE\LANSHARE.SYS
```

with the following two lines:

```
DEVICE=drive: \NETWARE\drivername.SYS
```

```
DEVICE=drive: \NETWARE\ROUTE.SYS
```

Replace *drive* with the letter of the drive where the \NETWARE directory is located. Replace *drivername* with TOKENSHR or TOKENLNK, depending on the network board sharing option you are using.

4. Start NetWare Server for OS/2.

You can start the server by double-clicking on the NetWare Server for OS/2 icon, or by changing to the \NWSERVER directory in an OS/2 window and typing

```
NWOS2 <Enter>
```

5. At the NetWare Server for OS/2 console prompt, type

```
LOAD INSTALL <Enter>
```

The “Installation Options” screen appears as shown in Figure 4-36 on page 186.

6. Choose “Driver Options.”

The “Driver Options” menu appears as shown in Figure 4-37 on page 187.

7. Choose “Configure Network Drivers.”

The “Additional Driver Actions” menu appears as shown in Figure 4-38 on page 188.

8. Choose “Deselect a Selected Driver.”

9. Choose “LANSHARE” from the “Selected Network Drivers” field.

10. **Press <Enter> to unload the selected driver.**

A message appears indicating that the selected driver has been successfully unloaded.

11. **Press <Enter> to continue.**

12. **Choose “Select an Additional Driver” from the “Additional Driver Actions” menu.**

A list of available LAN drivers appears.

13. **Select “TOKENSHR.LAN” or “TOKENLNK.LAN,” depending on the network board sharing option you are using.**

The “Parameters Actions” menu appears.

14. **Choose “Save Parameters and Load Driver.”**

15. **Enter an IPX external network number, or press <Enter> to accept the randomly generated IPX external network number.**

A message appears asking if you want to select an additional network driver.

16. **Choose “No.”**

The “Additional Driver Actions” menu appears again.

17. **Choose “Return to the Previous Menu.”**

The “Installation Options” menu appears as shown in Figure 4-36 on page 186.

18. **Choose “Exit” to exit INSTALL.**

19. **Bring down the server and reboot your computer so that the changes will take effect.**

Changing from TOKENSHR or TOKENLNK to LANSHARE

Procedure

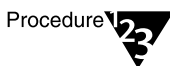

1. **Open the CONFIG.SYS file in an OS/2 text editor by typing the following in an OS/2 window**

EPM CONFIG.SYS <Enter>

2. Delete the following two lines from the CONFIG.SYS file.

```
DEVICE=drive: \NETWARE\drivename.SYS  
DEVICE=drive: \NETWARE\ROUTE.SYS
```

Replace *drive* with the letter of the drive where the \NETWARE directory is located. Replace *drivename* with TOKENSHR or TOKENLNK, depending on the network board sharing option you are using.

3. Add the following line to the CONFIG.SYS file.

```
DEVICE=drive: \NETWARE\LANSHARE.SYS
```

Replace *drive* with the letter of the drive where the \NETWARE directory is located.

4. Start NetWare Server for OS/2.

You can start the server by double-clicking on the NetWare Server for OS/2 icon, or by changing to the \NWSERVER directory in an OS/2 window and typing

```
NWOS2 <Enter>
```

5. At the NetWare Server for OS/2 console prompt, type

```
LOAD INSTALL <Enter>
```

The “Installation Options” screen appears as shown in Figure 4-36 on page 186.

6. Choose “Driver Options.”

The “Driver Options” menu appears as shown in Figure 4-37 on page 187.

7. Choose “Configure Network Drivers.”

The “Additional Driver Actions” menu appears as shown in Figure 4-38 on page 188.

8. Choose “Deselect a Selected Driver.”

- 9. Choose “TOKENSHR” or “SRBRIDGE,” depending on the network board sharing option you are using.**

SRBRIDGE is the multiple protocol source routing bridge driver used with TOKENLNK.LAN.

- 10. Press <Enter> to unload the selected driver.**

A message appears indicating that the selected driver has been successfully unloaded.

- 11. Press <Enter> to continue.**

- 12. Choose “Select an Additional Driver” from the “Additional Driver Actions” menu.**

A list of available LAN drivers appears.

- 13. Choose “LANSHARE” from the list of available drivers.**

The “Parameters Actions” menu appears.

- 14. Choose “Save Parameters and Load Driver.”**

- 15. Enter an IPX external network number, or press <Enter> to accept the randomly generated IPX external network number.**

A message appears asking if you want to select an additional network driver.

- 16. Choose “No.”**

The “Additional Driver Actions” menu appears again.

- 17. Choose “Return to Previous Menu.”**

The “Installation Options” menu appears.

- 18. Choose “Exit” to exit INSTALL.**

- 19. Bring down the server and reboot your computer so that the changes will take effect.**

This chapter describes how to install the NetWare 4.11 SFT III™ operating system on two network servers: a NetWare® 4.11 server (Server 1), and a computer that doesn't have NetWare installed on it (Server 2).

Important



You must have NetWare 4.11 installed on one server or NetWare SFT III 3.11 installed on two servers before you can install NetWare 4.11 SFT III.

To upgrade from NetWare SFT III 3.11 to NetWare 4.11 SFT III, see “Upgrade from SFT III 3.11 and 4.1” on page 213.

If you have	Do the following
NetWare 2.x, 3.x, or 4.x installed on one server	<i>Upgrade to NetWare 4.11.</i>
NetWare 4.11 installed on one server	Begin with “Prerequisite Tasks” on page 200.
NetWare SFT III 3.11 installed on two servers	Follow steps in “Edit SFT III 3.11 .NCF Files (Optional)” on page 214.

Necessary Resources

Checklist



- The NetWare 4.11SFT III Installation quick path card to get an overview of the process.
- Two similar (preferably identical) 386, 486, or Pentium* computers (certified by Novell®) to be used as NetWare servers. Both computers must have similar (preferably identical)
 - ◆ CPU speed, memory, and storage capacity
 - ◆ Brand and version of DOS (3.1 or later)

- ◆ Monitors (both monochrome or both color) and monitor boards (both VGA or both EGA, for example)
- A minimum of 16 MB of RAM in each NetWare server. (Some configurations may require more RAM.)
- CPU hardware running at a minimum of 25 MHz in each NetWare server.
- A CD-ROM drive and drivers installed as a DOS device on Server 1.
- A diskette drive on each server. (NetWare 4.11 *Main Server License* diskette is 3 1/2 inches)
- The NetWare 4.11 *Operating System* CD-ROM.
- The *NetWare 4.11 SFT III License* diskette.
- (Optional) Working copies of third-party disk drivers, LAN drivers, MSL™ drivers, or NLMs™.
- A Mirrored Server Link (MSL) connecting the two servers.

The following table lists the third-party MSL boards certified at the time of publication. Additional boards may have been certified since. For full details on MSL board compatibility with NetWare 4.11 SFT III, call one of the following numbers

Faxback:1-801-861-2776
 1-800-414-LABS (5227)
 Hotline:1-801-861-5544

Table 5-1

Company/Board Name	Bus type	Driver name
Digital Equipment Corporation 1-800-DIGITAL or 1-603-884-6660		
DEC* DEFEA Series Adapter for MSL	EISA	DECMSL4X.MSL

Table 5-1

Eagle Technology 1-800-733-2453 or 1-408-441-7453		
NMSL NE2000® (limited) NE/2-32® (limited)	EISA ISA MCA	NMSL.MSL HNE2000.MSL HNE232.MAL
Microdyne 1-800-255-3967 or 1-703-329-3700		
NMSL	EISA	NMSL.MSL
Plaintree Systems 1-800-370-2724 or 1-617-239-8077		
WaveBus MSL (latest)	EISA, MCA	WBMSL.MSL
Thomas Conrad Corporation 1-800-332-8683 or 1-512-836-1935		
Thomas Conrad MSL (latest)	EISA, MCA, ISA	TCMSL.MSL
TCNS* MSL (latest)	EISA, MCA, ISA	TCMSL.MSL
TCNS* MSL Adapters (latest)	EISA, MCA, ISA	TCMSL.MSL
SysKonnnect 1-408-725-4650		
SK-Net Series MSL	EISA MCA ISA	SKFEMSL.MSL SKFMMSL.MSL SKFMSL.MSL
Vinca 1-801-223-3100		
V32 MSL	EISA, MCA, ISA	V32MSL.MSL

Prerequisite Tasks



- Install NetWare 4.11 on Server 1. (See Chapter 3, “Custom Installation,” on page 59.)
- Create a DOS partition on Server 2 that is preferably the same size as the DOS partition on Server 1 (at least 15 MB).

If you wish to accommodate core dumps to your hard drive, make the DOS partitions 15 MB plus the number of megabytes (MB) of RAM per server. For example, if each server has 16 MB of RAM, the DOS partition would be at least 31 MB (15 MB + 16 MB).

- Format three high-density diskettes and label them “Disk 1,” “Disk 2,” and “Disk 3.”
- Install MSL (Mirrored Server Link™) boards in Server 1 and Server 2. Cable the MSL boards in each server directly to each other (as shown in Figure 5-1). See the MSL board manufacturer’s documentation for installation details.

Note the MSL board’s address and the interrupt number for use later during installation.

Figure 5-1
MSL Installation

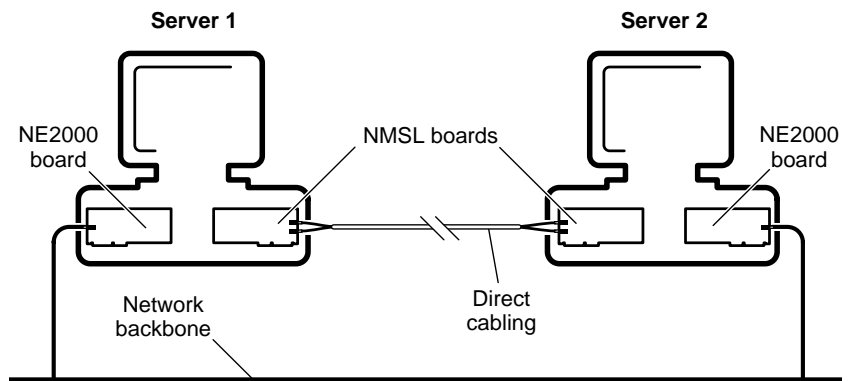

For best performance, assign the MSL board a higher priority interrupt than the network boards in the server.

- (Optional) Install and cable an alternate MSL board in each server for hardware redundancy in case of primary MSL board failure.

Install SFT III Servers

The installation of NetWare 4.11 SFT III includes these procedures:

- ◆ Naming and numbering the server engines
- ◆ Copying NetWare 4.11 SFT III files
- ◆ Choosing MSL (Mirrored Server Link) drivers
- ◆ Installing NetWare 4.11 SFT III on Server 2
- ◆ Creating and mirroring the NetWare partitions

Name and Number the Server Engines

Procedure



Procedure

1. Insert the NetWare 4.11 *Operating System* CD-ROM into the CD-ROM drive on Server 1.
2. Turn on the CD-ROM drive.
3. Boot DOS on Server 1.
4. Change to the root directory of the CD-ROM drive.

For example, type

D: <Enter>

CD\ <Enter>

5. Type

INSTALL <Enter>
6. Select the language in which you want to install the software.
7. Select “NetWare Server Installation.”
8. Select “NetWare 4.11 SFT III.”

A menu displaying NetWare 4.11 SFT III installation options appears.

9. Select “Convert NetWare 4.11 to SFT III.”

10. In the space provided, type the MEngine name and press <Enter>.

By default, the name you assigned to Server 1 when you installed NetWare 4.11 appears in the box. You may use this name for the MEngine, or type in a different name.

The MEngine name should be a unique name that is 2 to 47 characters long, with no periods or spaces. Valid characters are A-Z, 0-9, hyphen, and underscore.

SFT III requires three unique server names: one for the mirrored operating system functions (MEngine), and one for each server’s input and output functions (IOEngine).

The system creates two IOEngine names by appending the characters “_IO1” and “_IO2” to the MEngine name.



For more information see “MEngine” and “IOEngine” in *Concepts*.

11. Specify IPX internal network numbers for each engine by doing one of the following:

11a. Select “Continue with Installation” to accept the randomly-generated numbers.

11b. Select “Modify Network Numbers” to assign your own IPX internal network numbers.



Each internal network number should be a unique, hexadecimal number that is one to eight digits long. You can’t assign an IPX internal network number of “0” or “FFFFFFFF.”

Each IOEngine must have its own unique IPX internal network number, and the MEngine number must be different from both IOEngine numbers.

Copy NetWare 4.11 SFT III Files

Procedure

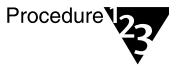

1. **On Server 1, accept the default DOS boot directory or specify a new one.**

The installation utility copies MSERVER.EXE and other SFT III-specific files to the boot directory.

If you specify a directory other than the one in which the STARTUP.NCF file for NetWare 4.11 is located, you will be asked to provide the location of STARTUP.NCF.

2. **Choose whether or not to modify the IOSTART.NCF file.**

The SET Reserved Buffers Below 16 Meg=200 command has been added to the IOSTART.NCF file. This command is necessary for some drivers. If you are certain the driver you are using doesn't need it, you can delete this command from the IOSTART.NCF file.

The documentation that came with the driver should tell you if the driver requires this command. If the driver requires it, and it isn't present, the server won't work.

Some drivers also require that memory above 16 MB be disabled while the driver loads. In that case, you will need to add the SET Auto Register Memory Above 16 Megabytes=Off command to the IOSTART.NCF file.

3. **Specify the location of your AUTOEXEC.BAT file.**

If SERVER.EXE is in Server 1's AUTOEXEC.BAT file, the installation utility changes SERVER.EXE to MSERVER.EXE.

4. **Specify the diskette drive letter for Server 1.**

5. **Insert *Disk 1* (a blank, formatted, high-density diskette) into the diskette drive on Server 1 and press <Enter>.**

The installation utility copies SFT III-specific files, MSL drivers, and batch files to Disk 1.

If the diskette isn't blank, answer "Yes" to the prompt, "This diskette is not empty. Delete data and proceed?" If you wish to

retain the data currently on the diskette, replace it with a blank diskette.

6. Insert the other two diskettes as prompted.

The installation utility copies MSERVER.EXE and installation batch files to *Disk 2* and *Disk 3*.

Choose Mirrored Server Link (MSL) Drivers

Procedure

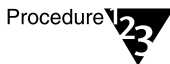

1. **Specify the MSL driver for the MSL board installed in Server 1.**
2. **(Conditional) If the MSL board uses an MSL driver not listed on the screen, press <Ins>.**
 - 2a. **Specify the drive for the MSL driver diskette.**
 - 2b. **Select the MSL driver.**
 - 2c. **Specify the memory address and interrupt number for the MSL board.**
3. **(Conditional) If you installed an alternate MSL board in Server 1, specify an additional MSL driver.**

The INSTALL program loads the IOEngine on Server 1. After the MSL driver loads, installation on Server 1 is complete.

Install SFT III on Server 2

Procedure

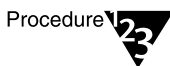

1. **Leave Server 1 running and take the three DOS diskettes, the driver diskette(s), and the *NetWare 4.11 SFT III License* diskette to Server 2.**
2. **Boot DOS on Server 2.**
3. **Insert *Disk 1* into the diskette drive on Server 2.**
4. **Change to the diskette drive on Server 2 and type**

INSTALL <Enter>

The installation utility copies MSERVER.EXE, SFT III-specific files, MSL drivers, and batch files to Server 2's boot directory, which is the same as on Server 1.

5. **When prompted, insert *Disk 2* and *Disk 3* into the diskette drive on Server 2 and press <Enter>.**
6. **After the files have been copied, remove *Disk 3* from the diskette drive.**
7. **Specify the MSL driver for the MSL board installed in Server 2.**
8. **(Conditional) If the MSL board uses an MSL driver not listed on the screen, press <Ins>.**
 - 8a. **Specify the path to the MSL driver diskette.**
 - 8b. **Select the MSL driver.**
 - 8c. **Specify the memory address and interrupt for the MSL board.**
9. **(Conditional) If you installed an alternate MSL board in Server 2, specify an additional MSL driver.**

Important



Load the MSL drivers on Server 2 in the same order they were loaded on Server 1.

The installation utility loads the IOEngine on Server 2, synchronizes the memory, and executes the ACTIVATE SERVER command. ACTIVATE SERVER loads the MEngine. The two server consoles display the same installation screen.

10. **Choose the server drivers for the hardware installed in Server 2.**

If Server 2's LAN and Disk hardware are the same as the hardware in Server 1, select "Make Drivers on the New Machine the Same as the Original."

11. **From the "Driver Actions" menu, select "Continue Installation."**

The disk and LAN drivers for Server 1 load, and the IPX external network numbers bound to the network boards in Server 1 are displayed.

Note the board names if you have multiple network boards of the same type in the server.

12. Continue by pressing <Enter>.

The disk and LAN drivers for Server 2 load, and you are prompted to accept or change the protocols bound to the network boards in Server 2.

Note the board names if you have multiple network boards of the same type in the server.

13. Continue by pressing <Enter>.

Create and Mirror the NetWare Disk Partitions

Procedure

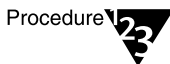

1. Choose a partitioning method.

“Automatically” creates a NetWare disk partition in the available free space on Server 2, then mirrors the NetWare disk partition from Server 1 to Server 2. This method assumes that the disk storage is identical on both machines.

“Manually” allows you to specify the NetWare partition size and Hot Fix™ Redirection Area on Server 2. Then, you must set up disk mirroring between the two servers’ disk partitions.

1a. If you chose “Automatically,” go to Step 15.

1b. If you chose “Manually,” continue with Step 2.

2. Select “Create, Delete, and Modify Disk Partitions.”

3. From the “Available Disk Drives” menu, select the disk drive for Server 2 (*MSEngineName_IO2*).

4. Select “Create NetWare Disk Partition” and press <Enter>.

5. **Specify the NetWare partition size on the disk drive for Server 2 (*MSEngineName_IO2*) so that it matches the size of the NetWare partition for Server 1 (*MSEngineName_IO1*).**



If you don't make the NetWare partitions the same size on both servers, they will not mirror.

- 5a. **From the "Disk Partition Information" screen, highlight the number next to "MB" on the "Partition Size" line.**
- 5b. **Type the size of the NetWare partition in megabytes (MB) and press <Enter>.**
- 5c. **Continue by pressing <F10>.**
6. **When prompted to "Create NetWare Partition," choose "Yes."**
7. **Return to "Disk Partition and Mirroring Options" by pressing <Esc> twice.**
8. **Set up disk mirroring between the two servers by selecting "Mirror/Unmirror Disk Partition Sets."**



Mirror each disk to a disk on the other server. This preserves your data if one server goes down.

9. **Select the disk partition for Server 1 (*MSEngineName_IO1*) and press <Enter>.**
10. **Add the disk partition for Server 2 (*MSEngineName_IO2*) to the mirrored set by pressing <Ins>.**
11. **Select the disk partition for Server 2 (*MSEngineName_IO2*) and press <Enter>.**
12. **Continue by pressing <F10>.**

The "Disk Partition Mirroring Status" list appears.

An "In Sync" status on one partition alone does not mean the disk data is mirrored. After disk mirroring is complete, *both* partitions will be "In Sync."

13. **Return to "Disk Partition and Mirroring Options" by pressing <Esc>.**

The percentage of mirroring completed appears. You can continue the installation process while the disks are mirroring.

14. **Select “Continue with Installation” and press <Enter>.**

The installation utility mounts volume SYS:.

15. **When prompted, insert the *NetWare 4.11 SFT III License* diskette into the drive on Server 2 and press <Enter>.**

Installation on both NetWare 4.11 SFT III servers is now complete.

Although the installation process is finished, disk mirroring continues in background mode. The mirror status is displayed on the screen.



Do not bring down the server or turn on Server Test Mode until the disks are fully mirrored. Otherwise, data may be lost.

16. **Exit the installation utility or edit the server configuration files as explained below.**

Edit Server Configuration Files (Optional)

When you turn on or restart the servers, NetWare 4.11 SFT III reads from server configuration files with the .NCF filename extension that were automatically created by the installation utility.

After you set up disk mirroring, you can edit the .NCF files to customize your NetWare 4.11 SFT III system with additional LOAD commands or SET parameters. You can cut from one file and paste to another.

To cut text, press <Tab> to move to the window from which you want to copy. Use the arrow keys to place the cursor at the beginning of the text you wish to copy. Press <F5> and then use the arrow keys to place the cursor at the end of the text you wish to copy. The selected text will be highlighted. Press <delete> to cut. Press <F6> to copy.

To paste text, press <Tab> to move to the window into which you want to copy. Use the arrow keys to place the cursor at the point you want to paste and then press <Ins>.

Table 5-2 lists the SFT III server configuration files, locations, and contents.

Table 5-2
SFT III Configuration Files in Order of Execution

File	Location	Contents
IOSTART.NCF (Two files—one for each server)	DOS partition	IOEngine name and IPX internal network number; loading instructions for disk drivers and MSL drivers; IOEngine SET parameters; loading instructions for NLMs that do not require an active MEngine or a mounted volume SYS:.
MSSTART.NCF (Two identical files)	DOS partition of each machine in the startup directory with MSERVER.EXE	Commands that are executed by the MEngine after the server is mirrored but before the system volume is mounted. Some SET parameters can be set only in MSSTART.NCF.
MSAUTO.NCF	SYS:SYSTEM	Commands that are executed by the MEngine after the server is mirrored and the system volume mounted; initialization commands for Time Services; Directory Services, and most other Mirrored-Server NLMs; name and IPX internal network number; loading instructions for MEngine NLMs.
IOAUTO.NCF (Two files—one for each server)	DOS partition or Volume SYS:	Commands for loading network drivers and binding network protocols; loading instructions for NLMs that require an active MEngine and a mounted volume SYS: (such as printing and backup NLMs).

Changes to commands in the .NCF files do not take effect until you reboot the server.

Edit the IOSTART.NCF Files

Procedure



From the MSEngine prompt on either SFT III server, type

```
INSTALL <Enter>
```

17. **Select “NCF Files” and edit the IOSTART.NCF files for each NetWare server.**

Select the IOSTART.NCF option for Server 1.

Example of IOSTART.NCF for primary IOEngine:

```
ioengine name SFT3_IO1
ioengine ipx internal net 7654321
load isadisk port=1f0 int=e
load nmsl
```



The LOAD command for the MSL driver should be the last line of the IOSTART.NCF file. The disk and MSL drivers should be in the same directory as MSERVER.EXE.

18. **Save the file by pressing <F10> or <Esc> and then <Enter>.**
19. **Select the IOSTART.NCF option for Server 2.**

Example of IOSTART.NCF for secondary IOEngine:

```
ioengine name SFT3_IO2
ioengine ipx internal net 6543210
load isadisk port=1f0 int=e
load nmsl
```



The LOAD command for the MSL driver should be the last line of the IOSTART.NCF file.

20. **Save the file by pressing <Esc> and then <Enter>.**

Edit IOAUTO.NCF Files

Procedure

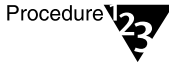

1. From “NCF Files,” select the IOAUTO.NCF option for Server 1.

Example of IOAUTO.NCF file:

```
LOAD NE2000 INT=3 PORT=300 FRAME=ETHERNET_802.2
  NAME=NE2000_2_E82
BIND IPX NE2000_2_E82 NET=1012672
```

2. Edit the file to load additional modules in Server 1’s IOEngine.
3. Save the file by pressing <Esc> and then <Enter>.
4. Select the IOAUTO.NCF option for Server 2.
5. Edit the file to load modules in Server 2’s IOEngine.
6. Save the file by pressing <Esc> and then <Enter>.

Edit MSAUTO.NCF Files

Procedure

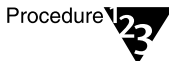

1. From “NCF Files,” select the MSAUTO.NCF option.
2. Edit the file to change the MEngine name or IPX internal network number.

Changes to the MEngine name or IPX internal network number do not take effect until after you bring down both servers and reboot them.

3. Save the file by pressing <Esc> and then <Enter>.

Edit MSSTART.NCF Files

Procedure



1. From “NCF Files,” select the MSSTART.NCF option.
2. Type instructions in the MSSTART.NCF file to customize the SET parameters for your MEngine.

MEngine parameters that can be set only in the MSSTART.NCF file include Minimum Packet Receive Buffers, Cache Buffer Size, Maximum Subdirectory Tree Depth, Auto TSS Blackout Flag, and Concurrent Remirror Requests. See SFT III Parameters under “SET” in *Utilities Reference*.

3. Save the file by pressing <Esc> and then <Enter>.

View SFT III Console Displays

SFT III servers have three console displays: the primary IOEngine, the secondary IOEngine, and the MEngine.

Press <Alt> to see the console title bar. The right side of the title bar indicates the primary or secondary console.

Press <Alt>+<Esc> or <Ctrl>+<Esc> to view the server console displays in SFT III.

- ◆ To select the primary IOEngine, the secondary IOEngine, the MEngine, or other console displays (such as the installation screen), press <Alt>+<Esc>.
- ◆ To display a menu of console options, press <Ctrl>+<Esc>. Type the number of the console you wish to display.

Implement Dual Processing (Optional)

To implement dual processing with NetWare 4.11 SFT III, you must have a server with two CPUs installed and a dual-processing driver (available from your server hardware manufacturer).

A second processor may be installed in one or both SFT III servers.

Follow the procedure below to assign one CPU to the IOEngine and one CPU to the MEngine.

Procedure

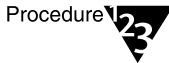

1. **From the IOEngine console of the server with two CPUs installed, load the dual processing driver.**

See the server hardware manufacturer's installation instructions for loading the dual processing driver. For example, type

```
LOAD 2NDPROC <Enter>
```

2. **To implement dual processing at startup, put the load command in the IOSTART.NCF file of the server with two CPUs.**

Upgrade from SFT III 3.11 and 4.1

Necessary Resources



- The NetWare 4.11 SFT III Installation quick path card to get an overview of the process
- NetWare SFT III 3.11 or 4.1 installed on two servers
- A CD-ROM drive on one server
- A diskette drive on each server
- The NetWare 4.11 *Operating System* CD-ROM and the NetWare 4.11 *Main Server License* diskette
- The *NetWare 4.11 SFT III License* diskette
- Three formatted, high-density diskettes labeled "Disk 1," "Disk 2," and "Disk 3"

Prerequisite Tasks



- Back up your NetWare SFT III 3.11 or 4.1 servers, including files in the DOS partitions of both servers.

- Note the directory in which MSERVER.EXE currently resides if you plan to install version 4.11 in the same directory as the previous NetWare version.
- Make sure that all users are logged out.
- Bring down the MSEngine and both IOEngines.

Edit SFT III 3.11 .NCF Files (Optional)

Before upgrading your NetWare SFT III servers to NetWare 4.11 SFT III, edit both servers' .NCF files if

- ◆ The .NCF files contain LOAD commands for third-party drivers or modules that aren't compatible with NetWare 4.11. To determine which drivers and modules are compatible with NetWare 4.11, call one of the following numbers:

Faxback:1-801-861-2776
 1-800-414-LABS (5227)
 Hotline:1-801-861-5544

Update the LOAD commands with the 4.11 driver or module names and the appropriate path names (if not on volume SYS:).

- ◆ Your servers use the Ethernet 802.3 frame type, but the frame type is not specified in the .NCF files.

Specify the 802.3 frame type in the LOAD command in the IOAUTO.NCF files. For example, type

```
LOAD NE2000 FRAME=ETHERNET_802.3 INT=3 PORT=300
```

- ◆ The .NCF files contain old SET parameter names. Use the table below to update SET parameter names from previous versions to NetWare 4.11 SFT III SET parameter names.

Old SET parameter names	SFT III 4.11 SET parameter names
Mirrored Server Comm ACK Wait Time Out	MSL Error Wait Time

Old SET parameter names	SFT III 4.11 SET parameter names
Secondary Take Over Delay Amount	Secondary Take Over Wait Time
Comm Deadlock Detect Wait Time	MSL Deadlock Wait Time
Check Server to Server Comm	Extra MSL Checking
Primary Server Comm Deadlock Recovery Option	Primary Server MSL Deadlock Recovery Option
Secondary Server Comm Deadlock Recovery Option	Secondary Server MSL Deadlock Recovery Option
MSEngine Outputs Different	MSEngine Outputs Different Recovery Option
Primary Server Comm Consistency Recovery Option	Primary Server MSL Consistency Error Recovery Option
Secondary Server Comm Consistency Recovery Option	Secondary Server MSL Consistency Error Recovery Option
Primary Server Comm Driver Stuck Recovery Option	Primary Server MSL Send Blocked Recovery Option
Secondary Server Comm Driver Stuck Recovery Option	Secondary Server MSL Send Blocked Recovery Option
Primary Server Comm Hardware Failure Recovery Option	Primary Server MSL Hardware Failure Recovery Option
Secondary Server Comm Hardware Failure Recovery Option	Secondary Server MSL Hardware Failure Recovery Option
Notify Users Of Mirrored Server Synchronization	Notify All Users Of Mirrored Server Synchronization
Notify Users Of Mirrored Server Failures	Server Failure Notification Name

Upgrade Server 1

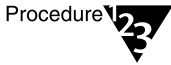

Procedure

1. **Install the DOS CD-ROM drivers on the server with the CD-ROM drive.**
2. **Insert the NetWare 4.11 *Operating System* CD-ROM into the CD-ROM drive on Server 1.**
3. **Turn on the CD-ROM drive.**
4. **Boot DOS on Server 1.**
5. **Change to the root directory of the CD-ROM drive.**

For example, type

```
D: <Enter>  
CD\ <Enter>
```

6. **Type**

`INSTALL` <Enter>
7. **Select the language in which you want to install the software.**
8. **Select “NetWare Server Installation.”**
9. **Select “NetWare 4.11 SFT III.”**

A menu displaying SFT III installation options appears.
10. **Select “Upgrade Current SFT III to SFT III 4.11” and press <Enter>.**
11. **Specify the path for the destination directory.**

The destination directory can be the directory where the 3.11 version of MSERVER.EXE currently resides or it can be a new directory.



If you install to the directory where the 3.11 version resides, you should first backup that directory. The installation utility will overwrite existing files when it copies the 4.11 MSERVER.EXE and other SFT III-specific files to the destination directory.

12. **(Conditional) Check the list of third-party drivers that were not updated in the DOS boot directory. These drivers may be compatible with NetWare 4.11, but if they are not you will need NetWare 4.11-compatible replacements on diskette.**
13. **Specify the locale configuration and file format.**
See “Specify Language and Filename Format Information” on page 66.
14. **Create diskettes for Server 2.**
Insert *Disk 1*, *Disk 2*, and *Disk 3* as prompted.
15. **Remove *Disk 3* when the files have been copied.**
16. **Take the three diskettes to Server 2.**

Upgrade Server 2

Procedure

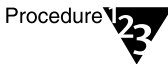

1. **Boot DOS on Server 2.**

If you are using third-party drivers on Server 2, you will have to copy the drivers to the DOS boot directory and SYS:SYSTEM manually. They will not be copied during the automated installation procedure.

2. **Insert *Disk 1* in the diskette drive of Server 2.**
3. **Change to the diskette drive and type**
`INSTALL <Enter>`
4. **Insert *Disk 2* and *Disk 3* when prompted.**
5. **Specify the path to the 3.11 IOSTART.NCF and MSSTART.NCF files from SFT III 3.11.**

6. Remove *Disk 3* when the files have been copied and you are prompted for the NetWare 4.11 *Main Server License* diskette.
7. Insert the NetWare 4.11 *Main Server License* diskette when prompted.
8. Insert the *SFT III License* diskette when prompted.
9. Choose a Directory tree or create a new Directory tree.
10. Specify the time zone and time configuration.
11. Specify the server context.
12. Specify the password for ADMIN.
13. Save the Novell Directory Services™ information.
NetWare files copy to the SYSTEM and PUBLIC directories.
14. (Conditional) If the IOSTART.NCF files contain load commands for network drivers, move those load commands from the IOSTART.NCF files to the IOAUTO.NCF files.

The upgrade to NetWare 4.11 SFT III is complete.

A**Calculate RAM Requirements****Overview**

Note

The following appendix is modified from a *Novell® Application Notes* article published in January 1995.

If you need to calculate the memory requirements for a new server or double check the memory requirements for an existing server, here is a convenient worksheet with updated calculations for server configurations.

Memory Calculation

Because it is important that you have accurate server memory calculations, we've examined NetWare® server memory requirements and created the attached worksheet. This new worksheet

- ◆ Replaces the versions of the calculation found in earlier NetWare 3™ and NetWare 4™ documentation
- ◆ Satisfies the memory requirements for both NetWare 3 and 4 server configurations
- ◆ Simplifies the process by using a single unit of measure
- ◆ Adds precision to the disk-related calculations by breaking out the file cache requirements into a separate calculation

The old calculations, which tagged file cache requirements onto the disk calculation, produced incorrect results as server disk capacities soared above 2 GB.

In the new worksheet, we've corrected the disk-related calculation and now allow you to figure your file cache requirement based on your total

number of clients. This is the correct way to figure file cache requirements.

Memory in NetWare 3 and 4

Only three differences between the NetWare 3 and 4 operating systems impact a server's memory requirement. We've built considerations for these differences into the worksheet so that memory requirements for both operating systems can be calculated on the same worksheet.

Core Operating System Requirements

The NetWare 4 operating system requires an additional 3 MB of memory. This memory supports the additional core services added to NetWare 4.

File Compression

File compression requires a static 250 KB of memory when activated.

Block Suballocation

Block suballocation requires five bytes of memory for every file managed by the server. This is an insignificant amount of memory for many systems.

The Worksheet

The attached worksheet requires you to know the following about your server:

- ◆ Total disk capacity

This is the total number of megabytes attached to your server. Use 1024 MB for each gigabyte.

- ◆ Total *usable* disk capacity

If your disk storage subsystem is duplexed or mirrored, this is half the total disk capacity above. Otherwise, the two numbers are equal.

- ◆ Total number of clients

This is the total number of end-users or connections that simultaneously use the server.

- ◆ Volume block size

This is the block size used during the installation of your NetWare volumes. The accuracy of this variable is important because volumes with 4 KB blocks require 16 times the amount of memory required by volumes with 64 KB blocks.

- ◆ Estimated total number of files

This is your estimate of the total number of files that will reside on the server. An estimate will suffice because the directory tables require only 6 bytes per file. If you're using block suballocation, this requirement increases to 11 bytes per file.

Once you've got this information, use it to calculate the server variables on the worksheet. Then run through the worksheet's ten line calculation to arrive at your server's total memory requirement.

Additional Memory Considerations

If you're building a server with Name Spaces, CD-ROM, NetWare for Macintosh, or other specialized server applications, the worksheet gives you a baseline memory requirement only. Look up the following resources and add the necessary memory at the bottom of the worksheet for an accurate total.

- ◆ Name Spaces

See Appendix B, "Name Space Requirements," on page 223.

Server Applications

Memory calculations for NetWare for Macintosh, NetWare for SAA, OracleWare, and other NetWare server applications can be found in their documentation and on the Network Support Encyclopedia (NSEpro) CD-ROM.

Figure A-1
NetWare 3 and 4 Server Memory Worksheet

STEP 1 Calculate the following variables.	
V1. Enter the total number of megabytes of disk connected to the server (For example: enter 1 for each MB, enter 1024 for each GB)	_____ MB
V2. Calculate the number of megabytes of useable disk space connected to the server (If you are mirroring or duplexing multiply V1 * 0.5, otherwise copy V1)	_____ MB
V3. Enter the server's volume block size (4, 8, 16, 32, or 64)	_____ MB
V4. Calculate the number of disk blocks per MB (divide 1024 / V3)	_____ Blocks/MB
V5. Calculate the total number of disk blocks (Multiply V2 * V4)	_____ Blocks
V6. Enter the maximum number of clients (end-users) attached to the server (For example: enter 24 for 24 end-users)	_____ Clients
V7. Enter the maximum number of files that will reside on the server	_____ Files
STEP 2 Calculate your individual memory requirements.	
Line 1. Enter the base memory requirement for the core OS (enter 2048 for NetWare 3, or 5120 for NetWare 4)	_____ KB
Line 2. Calculate the memory requirement for the Media Manager (multiply V1 * 0.1)	_____ KB
Line 3. If File Compression is enabled, enter 250, otherwise enter 0	_____ KB
Line 4. Calculate the memory requirement for directory tables (multiply V7 * .006, or if suballocation is enabled multiply V7 * .011)	_____ KB
Line 5. Calculate the memory required to cache the FAT (multiply Line V5 * .008)	_____ KB
Line 6. Calculate the memory requirement for file cache using the following table. This calculation uses a 0.4MB file cache per client memory requirement. The decrease as the user community size increases is based on assumptions regarding increased repetitive use of shared data (temporal and spacial locality) within cache. Less than 100 clients V6 * 400 Between 100 and 250 clients 40,000 + ((V6 - 100) * 200) Between 250 and 500 clients 70,000 + ((V6 - 250) * 100) Between 500 and 1000 clients 95,000 + ((V6 - 500) * 50)	_____ KB
Line 7. Enter the total memory (KB) required for support NLMs. 2,000KB is recommended for BTRIEVE(700), CLIB(500), INSTALL(600), and PSERVER(200)	_____ KB
Line 8. Enter the total memory (KB) required for other services. Other services include NetWare for Macintosh, NetWare for SAA, OracleWare, NetWare Management System, and so on.	_____ KB
STEP 3 Calculate your total memory requirement.	
Line 9. Total Lines 1.. 8 for your total memory requirement (in KB)	_____ KB
Line 10. Divide Line 9 by 1024 for a result in MB Using this result, round up to the server's nearest memory configuration. NetWare will enhance server performance by using all leftover memory for additional file cache.	_____ MB

Overview



Note

The following appendix is modified from a *Novell® Application Notes* article published in January 1995.

In some cases additional name spaces require additional memory for directory cache and management. If you're installing additional name spaces on a NetWare® volume, you should follow the strategies in this appendix to size and tune your server's memory requirements. These sizing and tuning strategies resolve all of the additional memory requirements presented by name spaces.

The Directory Cache Connection

Each name space installed on a NetWare server's volumes requires support modules (NLM™ programs) and a modification to the server's directory entry tables (DET). The support modules require minimal memory for code. However, the modifications to each volume's DET require additional server memory for directory caching if the server's directory usage patterns are heavy and match several criteria.

With or without name spaces, all file and directory operations are handled through a single directory cache allocated and managed by NetWare. The purpose of the directory cache is to hold onto DET blocks recently read from the disk in anticipation of repeated use.

In NetWare 2, Novell cached the entire DET, but with the growth of disk capacities, fully cached directories became unrealistic for many servers. For example, a DOS file system containing 500,000 files requires 65 MB just to cache the DET. NetWare 3™ and NetWare 4™ use a most-recently-used (MRU) cache policy to manage their directory caches. The MRU policy keeps only the most recently used DET blocks in cache, tossing least-recently-used (LRU) blocks out when new DET blocks are

requested. The MRU policy is an efficient means of using a much smaller cache to provide access to a very large data structure.

NetWare also uses an auto-adjusting mechanism to manage the size of the directory cache based on specific directory usage patterns.

DET Ratios

When a name space is installed on a volume, the volume's DET is extended to include an additional directory entry for each file. For instance, on a volume supporting DOS, NFS, and HPFS, NetWare manages three directory entries for each file, one entry for each installed name space, including DOS.

During file creation and other directory-related file operations, multiple name space directory entries for each file remain contiguous and are located in the same DET block on disk and in cache. This contiguous relationship overcomes the scenario in which the entries are non-contiguous, forcing multiple DET blocks to be read to have access to all DET references to the same file.

Under NetWare's native DOS support, each block read into cache contains 32 entries that provide information linked to 32 files. This means that you have access to the directory information for 32 files without having to read another DET block from the disk. This ratio of files represented per DET block is important because additional name spaces alter it significantly.

Cache Memory Requirements

You need additional memory when you begin to cache the DET after adding one or more name spaces to one or more volumes on the server. When NetWare clients access a volume with additional name spaces, their access can be slowed because information stored in one directory cache buffer no longer represents 32 files. It represents 16, 10, or 8 files per DET block, depending on the number of name spaces configured on that volume.

For example, if you load a Macintosh name space on top of the native DOS name space, DOS and Macintosh clients have to traverse ten directory blocks to perform the same work that before required only the

traversal of five. The addition of the Macintosh name space doesn't change the directory entry block's ability to hold 32 entries, but now with two entries per file (one for each name space), the same directory entry block represents only 16 files. If you add another name space, the result is three entries per file, for a total of 10 files represented per DET block. Add an additional name space for four entries per file, and you have only eight files represented in each DET block.

The efficiency of your directory cache is decreased by a factor equal to the number of name spaces you have installed.

Sizing Server Memory

To calculate your baseline server memory requirement, use the worksheet in Appendix A, "Calculate RAM Requirements," on page 219. In addition to this baseline memory requirement, additional name spaces require six bytes of memory for each directory entry.

Using the variables at the beginning of the worksheet, multiply $(V7 * .006) * \text{the number of additional name spaces installed on the server.}$ ($V7$ is the maximum number of files that will reside on the server.) If the additional name spaces are installed on specific volumes, this calculation need be performed only for the maximum number of files on the affected volumes.

Three Tuning Strategies

As with the tuning of any NetWare parameter, sizing the directory cache depends largely on the characteristics of the workload the server will be servicing—in this case, the directory access patterns exhibited by the server's user community. The key is the frequency and breadth of directory searches, file opens, closes, and creations. A low-use scenario could involve any number of users in which a small number of directories are shared or in which each users' activity remains within a small region of the directory. A high-use scenario could also involve any number of users, but user activity spans a very large number of directories and files.

Strategy 1: Handling Low Usage

At the low end, you won't need to allocate any more cache than NetWare's directory caching defaults permit. NetWare's defaults allow NetWare to allocate 20 buffers immediately upon request, followed by a maximum allocation of up to 512 directory cache buffers (2MB). This allocation is sufficient for the majority of NetWare servers.

Strategy 2: Handling Very High Usage

For the high end, you can adjust NetWare's auto-tuning facility, allowing it to allocate up to 8 MB of memory for directory cache immediately upon request, followed by a maximum allocation of up to 16 MB of total directory cache memory. These settings allow NetWare to cache up to 4096 directory cache blocks. To do this, place the SET parameters listed below in your server's AUTOEXEC.NCF file.

```
SET maximum directory cache buffers = 4000
```

```
SET minimum directory cache buffers = 2000
```

Strategy 3: Tuning the Cache

If neither strategy 1 or 2 matches your circumstances, use this strategy to tune your directory cache.

First, allow your server to operate in its production environment for several weeks. This allows NetWare's auto-tuning facility to allocate the appropriate number of directory cache buffers.

Next, use MONITOR.NLM to inspect the number of allocated directory cache buffers. This number is found in the "Directory cache buffers" value in the "General Information" screen and is used in the table below. Multiply this value by the total number of name spaces (including native DOS support) to arrive at a new buffer allocation.

For	Do
Native DOS support	Nothing.
Native DOS support plus one additional name space	Multiply the directory cache buffer by 2.

For	Do
Native DOS support plus two additional name spaces	Multiply the directory cache buffer by 3.
Native DOS support plus three additional name spaces	Multiply the directory cache buffer by 4.
Native DOS Support plus four additional name spaces	Multiply the directory cache buffer by 5.

Use the resulting buffer allocation to set the new minimum for the server, as shown in the SET parameters below. After setting the minimum, set the maximum to at least 100 buffers above the minimum, allowing the directory cache some room to grow under peak workloads.

```
SET minimum directory cache buffers =
NewBufferAllocation
SET maximum directory cache buffer =
    NewBufferAllocationCeiling
```

These new settings allow NetWare to freely allocate new directory cache buffers in a multi-name space environment, and increase the likelihood that (1) repeatedly used directory cache buffers remain in cache, and (2) those buffers remain in cache longer. The resulting directory cache is designed to support systems that house additional name spaces with the best possible read-path response times.

If, with these changes and a settling-in period, the server doesn't perform the anticipated allocation, then you know that your user community's directory access patterns don't require the additional cache. If, on the other hand, your server uses all the cache you made available, it's possible that your user community's directory access patterns are larger than you anticipated.

Based on your knowledge of the end-users' application and response time requirements, the server's allocation of directory cache might suggest the addition of more directory cache resources. The price, after all, is low: each additional 100 cache buffers add 3,200 directory entries to cache in exchange for 0.4 MB of server memory.

Just remember that any memory given to the directory cache is taken from the server's file cache. If you continue to take memory from file

cache for directory cache, you might need to add memory to your server after sizing the directory cache appropriately.

This appendix lists the CCITT country codes you can use in specifying the NetWare[®] 4.11 server's context.

The country object is optional in the Directory tree, and can be used if you have a multinational organization or if you want to match the ISO X.500 standard. You can, however, comply with X.500 without specifying a country code.



The following list of country codes may be incomplete or inaccurate due to the constantly changing worldwide geopolitical situation.

Figure C-1
Country Codes

Country names and codes		
AF Afghanistan	BV Bouvet Island	CY Cyprus
AL Albania	BR Brazil	CZ Czech Republic
DZ Algeria	IO British Indian Ocean Territory	DK Denmark
AS American Samoa	VG British Virgin Islands	DJ Djibouti
AD Andorra	BN Brunei Darussalam	DM Dominica
AO Angola	BG Bulgaria	DO Dominican Republic
AI Anguilla	BF Burkina Faso	TP East Timor
AQ Antarctica	BI Burundi	EC Ecuador
AG Antigua and Barbuda	KH Cambodia	EG Egypt
AR Argentina	CM Cameroon	SV El Salvador
AW Aruba	CA Canada	GQ Equatorial Guinea
AU Australia	CV Cape Verde	ER Eritrea
AT Austria	KY Cayman Island	EE Estonia
AZ Azerbaijan	CF Central African Republic	ET Ethiopia
BS Bahamas	TD Chad	FK Falkland Islands (Malvinas)
BH Bahrain	CL Chile	FO Faroe Islands
BD Bangladesh	CN China	FJ Fiji
BB Barbados	CX Christmas Island	FI Finland
BY Belarus	CC Cocos (Keeling) Islands	FR France
BE Belgium	CO Colombia	FX France, Metropolitan
BZ Belize	KM Comoros	GF French Guiana
BJ Benin	CG Congo	PF French Polynesia
BM Bermuda	CK Cook Islands	TF French Southern Territories
BT Bhutan	CR Costa Rica	
BO Bolivia	CI Cote d'Ivoire	
BA Bosnia and Herzegovina	HR Croatia (Hrvatska)	
BW Botswana	CU Cuba	

continued ▼

Country names and codes *continued*

GA Gabon	MT Malta	SN Senegal
GM Gambia	MH Marshall Islands	SC Seychelles
GE Georgia	MQ Martinique	SL Sierra Leone
DE Germany	MR Mauritania	SG Singapore
GH Ghana	MU Mauritius	SK Slovakia
GI Gibraltar	YT Mayotte	SI Slovenia
GR Greece	MX Mexico	SB Solomon Islands
GL Greenland	FM Micronesia, Federated States of	SO Somalia
GD Grenada	MD Moldova, Republic of	ZA South Africa
GP Guadeloupe	MC Monaco	GS South Georgia and the South Snadwich Islands
GU Guam	MN Mongolia	ES Spain
GT Guatemala	MS Montserrat	LK Sri Lanka
GN Guinea	MO Morocco	SD Sudan
GW Guinea-Bissau	MZ Mozambique	SR Suriname
GY Guyana	MM Myanmar	SJ Svalbard and Jan Mayen Islands
HT Haiti	NA Namibia	SZ Swaziland
HM Heard and McDonald Islands	NR Nauru	SE Sweden
HN Honduras	NP Nepal	CH Switzerland
HK Hong Kong	NL Netherlands	SY Syrian Arab Republic
HU Hungary	AN Netherlands Antilles	TW Taiwan
IS Iceland	NC New Caledonia	TJ Tajikistan
IN India	NZ New Zealand	TZ Tanzania, United Republic of
ID Indonesia	NI Nicaragua	TH Thailand
IR Iran, Islamic Republic of	NE Niger	TG Togo
IQ Iraq	NG Nigeria	TK Tokelau
IE Ireland	NU Niue	TO Tonga
IL Israel	NF Norfolk Island	TT Trinidad and Tobago
IT Italy	MP Northern Mariana Islands	TN Tunisia
JM Jamaica	NO Norway	TR Turkey
JP Japan	OM Oman	TM Turkmenistan
JO Jordan	PK Pakistan	TC Turks and Caicos Islands
KZ Kazakhstan	PW Palau	TV Tuvalu
KE Kenya	PA Panama	UG Uganda
KI Kiribati	PG Papua New Guinea	UA Ukraine
KP Korea, Democratic People's Republic of	PY Paraguay	AE United Arab Emirates
KR Korea, Republic of	PE Peru	GB United Kingdom
KW Kuwait	PH Philippines	US United States
KG Kyrgyzstan	PN Pitcairn	UM United States Minor Outlying Islands
LA Laos, People's Democratic Republic of	PL Poland	UY Uruguay
LV Latvia	PT Portugal	UZ Uzbekistan
LB Lebanon	PR Puerto Rico	VU Vanuatu
LS Lesotho	QA Qatar	VA Vatican City State (Holy See)
LR Liberia	RE Reunion	VE Venezuela
LY Libyan Arab Jamahiriya	RO Romania	VN Vietnam
LI Liechtenstein	RU Russian Federation	VG Virgin Islands (British)
LT Lithuania	RW Rwanda	VI Virgin Islands (U.S.)
LU Luxembourg	SH St. Helena	WK Wake Islands
MA Macau	KN St. Kitts-Nevis	WF Wallis and Futuna Islands
MK Macedonia, The former Yugoslav Republic of	LC St. Lucia	EH Western Sahara
MG Madagascar	PM St. Pierre and Miquelon	YE Yemen
MW Malawi	VC St. Vincent and the Grenadines	YU Yugoslavia
MY Malaysia	WS Samoa	ZR Zaire
MV Maldives	SM San Marino	ZM Zambia
ML Mali	ST Sao Tome and Principe	ZW Zimbabwe
	SA Saudi Arabia	

appendix

D

Install To Boot From Floppy Diskette

At the time of publication, the option for booting a NetWare 4.11 server from a floppy diskette was valid. Since then, the necessary disk space required for supporting this option has exceeded the space limitation of standard diskettes. Therefore, this option is no longer supported for servers running NetWare 4.11.

Creating Client Diskettes

During installation, the “Other Installation Items” menu allows you to create client diskettes. If you don’t create client diskettes at that time, you can do so by following the procedures in this section.

Prerequisites

Format the appropriate number of high-density diskettes using the table below.

Table E-1
Formatted Diskettes for Clients

For	Format
NetWare Client 32 Administrative Utility	Two 3.5 or 5.25 inch diskettes.
NetWare DOS/Windows Client (VLM)	Five 3.5-inch or 5.25 inch diskettes.
NetWare DOS/Windows Client (VLM) for IP	Five 3.5-inch or 5.25 inch diskettes.
NetWare Client 32 for DOS and Windows 3.1x	Five 3.5-inch or 5.25 inch diskettes.
NetWare Client 32 for Windows 95	Five 3.5-inch or 5.25 inch diskettes.
NetWare Client for OS/2	Eleven 3.5-inch or 5.25 inch diskettes.

Create Client Diskettes

You can create client diskettes at the NetWare[®] 4.11 server, or from a DOS, Windows, or OS/2 workstation. Procedures for both methods follow.

Create Client Diskettes at the Server

Procedure



- 1. At the server console type**
`LOAD INSTALL <Enter>`
The "Installation Options" menu appears.
- 2. Choose "Product Options" and press <Enter>.**
The "Other Installation Actions" menu appears.
- 3. Select "Choose an Item or Product Listed Above" and press <Enter>.**
- 4. Choose "Make Diskettes" and press <Enter>.**
You are prompted to enter the path to the source directory where the NetWare 4.11 files are located.
- 5. Verify or change the source path and press <Enter>.**
A screen appears prompting you for your user name and password.
- 6. Enter your user name and password and press <Enter>.**
A menu appears showing a list of clients similar to that shown in Table E-1 above.
- 7. Select or deselect the clients you want copied by pressing <Enter>.**
- 8. Press <F10> to accept the marked clients and continue.**
- 9. Specify the destination to where the client files will be copied.**

By default, the client files are copied to drive A:. To specify a new path, press <F3> and type the new path.

10. Press <Enter> to accept the path.
11. Insert the formatted diskettes as prompted.

Create Client Diskettes from a Workstation

You can create client diskettes from a workstation either by using a CD-ROM drive connected directly to the workstation as a DOS device, or by mapping a drive to a server with the NetWare 4 *Operating System* CD-ROM mounted as a NetWare volume.

Procedure

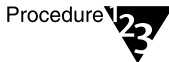

1. (DOS volume only) Install the CD-ROM drive as a DOS device according to manufacturer's instructions.
 - 1a. Go to the drive corresponding to the CD-ROM.
 - 1b. Change to the CLIENT directory.
 - 1c. Continue with Step 3.
2. (NetWare volume) If you set up the CD-ROM as a NetWare volume, complete the following steps:
 - 2a. Map a drive to the following path:

NW411:CLIENT
 - 2b. Change to the drive letter mapped to CD-ROM volume.
 - 2c. Continue with Step 3.
3. Change to one of the following subdirectories:

If creating diskettes for	Go to this subdirectory
DOS/Windows	DOSWIN
OS/2	OS2

Type

MAKEDISK *drive_letter*: *language* <Enter>

Replace *drive_letter* with the letter of the diskette drive you are inserting the empty formatted diskettes into.

Replace *language* with the language you want to install. The following languages are available: English, Francais, Deutsch, Italiano, Español.

For example, type

MAKEDISK A: *espanol* <Enter>

or

MAKEDISK B: *italiano* <Enter>

The MAKEDISK utility copies the client installation files from the CD-ROM directory to the diskettes. Follow the prompts to insert new empty formatted diskettes.

4. **Attach a label to each diskette and write the following on the corresponding labels.**

Table E-2
Client Diskette Labels

Diskette #	Label for DOS/Windows	Label for OS/2
1	<i>NetWare Client for DOS and Windows Disk 1</i>	<i>WSOS2_1</i>
2	<i>NetWare Client for DOS and Windows Disk 2</i>	<i>WSOS2_2</i>
3	<i>NetWare Client for DOS and Windows Disk 3</i>	<i>WSOS2_3</i>
4	<i>NetWare Client for DOS and Windows Disk 4</i>	<i>OSUTIL1</i>
5	<i>NetWare Client for DOS and Windows ODI LAN drivers</i>	<i>OS2DOC_X</i> <i>1 = English</i> <i>2 = French</i> <i>3 = German</i> <i>4 = Italian</i> <i>5 = Spanish</i>

Table E-2 *continued*

Client Diskette Labels

Diskette #	Label for DOS/Windows	Label for OS/2
6		WSDRV_1
7		VLMBOOT (optional)

Create Macintosh Client Diskettes

Follow the procedures below to create a Macintosh Client installation diskette.

Procedure

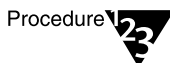

From an existing Macintosh workstation, log in to the server containing the installation files.

Before you can install the NetWare for Macintosh client software, you must prepare the files for installation.

If NetWare for Macintosh was installed on the server, the installation utility copied the client software to the server in the form of a self-extracting archive (MACNDS.SEA) file.

If you are installing from a NetWare drive after installing NetWare for Macintosh, connect to the server with bindery services enabled. Log in as user SUPERVISOR with bindery services enabled. Next, mount the volume on which you installed the client installation files.

5. Locate the correct self-extracting archive in the PUBLIC\MAC folder.

The MAC folder inside the PUBLIC folder contains at least one language folder. Each language folder is named according to the language in which its user interface is presented

For example, the archive of the English version of MacNDS is in the following location:

SYS : PUBLIC\MAC\ENGLISH\MACNDS . SEA

Likewise, the German archive resides in this location:

```
SYS:PUBLIC\MAC\DEUTSCH\MACNDS.SEA
```

6. Double-click the MACNDS.SEA file for your language.

A file dialog box appears, asking you where you want to put the extracted files. Select the default location to create a MACNDS folder within your language folder, or choose a different location if you want to store the extracted files elsewhere.

7. Copy the files from the server directory in which you extracted the MacNDS files to the 800KB floppy diskette.

8. Rename the floppy diskette.

The diskette should have the same name as the server directory containing the extracted MACNDS files (not the *.SEA files). This is the directory you created in Step 3.



If you do not name the diskette correctly, the installer will not work correctly. You will get an error message stating that you need to insert the correct diskette.

Install Using RCONSOLE

The RCONSOLE utility allows network supervisors to perform server console actions from a DOS client, or from a PC using a modem.

You can use the RCONSOLE utility on a DOS client to

- ◆ Install a NetWare 4™ server remotely through either a LAN, WAN, or modem.
- ◆ Install several NetWare 4 servers from a single remote location as shown in the figure below:

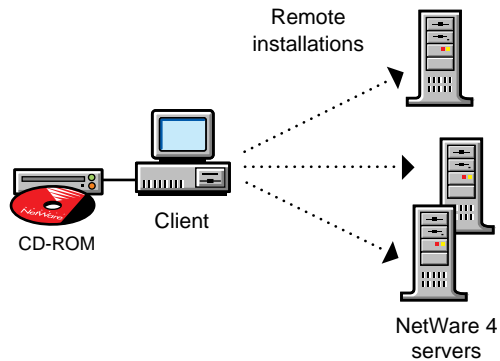

Hardware Configuration Requirements

You must have the following hardware configuration before installing using RCONSOLE:



- An existing DOS client with an installed CD-ROM drive.
- One or more computers (which will be referred to as “new servers”) meeting all of the hardware requirements listed under “Hardware Requirements” on page 12.
- Each computer connected to the DOS client via a LAN, WAN, or modem.

Prerequisite Tasks



- Plan your Directory tree. See *Guide to NetWare 4 Networks* for guidelines and suggestions.
- If the new server has never been a server before, complete the tasks explained in “Prepare to Install” on page 11.
- Run the new server’s Setup program and set its time to the exact local time. (The time synchronization feature in Novell Directory Services™ uses the computer’s time setting.)
- If necessary, partition and format your hard disk. Boot from the NetWare® *License* diskette; type FDISK and follow the screen prompts to partition the hard disk. Reboot the machine and type FORMAT to format the partition.

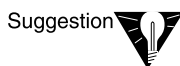

We suggest you create a 15MB DOS partition. This will store the NetWare 4.11 server boot files.



Reformatting your hard disk erases all stored files. Be sure to back up your hard disk prior to partitioning and formatting.

Necessary Resources

Checklist



- The NetWare 4.11 *License* diskette
- The NetWare 4.11 Operating System CD-ROM
- Two high-density floppy diskettes

Copy Files For the New Server

Follow the procedures below to copy the files needed by the new server.

Procedure

Procedure



1. **At the DOS workstation, insert the *NetWare 4.11 Operating System* CD-ROM into the CD-ROM drive.**
2. **Change to the **BOOT** directory of the CD-ROM.**

For example, if the CD-ROM drive were drive D:, the path would be:

D: \NW411 \BOOT

3. **Copy the following files onto the floppy diskettes:**
 - ◆ RSPX.NLM (for a remote installation from a workstation) or RS232.NLM (required only for an installation via modem)
 - ◆ REMOTE.NLM
 - ◆ NWSNUT.NLM
 - ◆ INSTALL.NLM
 - ◆ CLIB.NLM (required only for an installation using a modem)
 - ◆ STREAMS.NLM (required only for an installation using a modem)
4. **Change to the **NATIVE** subdirectory.**

For example:

D:\NW411\BOOT\NATIVE

- 5. Copy the SERVER.EXE file onto one of the diskettes.**
- 6. (Conditional) If you will be installing over a modem, change to the SYSTEM directory.**

For example, if the CD-ROM drive were drive D:, the path would be:

D:\NW411\SYSTEM

- 7. (Conditional) If you will be installing over a modem, copy the AIO.NLM file (and any communications port driver) on one of the floppy diskettes.**
- 8. Change to the PREINST subdirectory.**

For example, if the CD-ROM drive were drive D:, the path would be:

D:\NW411\SYSTEM\PREINST

- 9. Copy the ICMD.NLM file onto one of the two diskettes.**
- 10. Copy applicable topology files.**

The remaining files to be copied vary, depending on your topology and network board.

For example, if you were using an Ethernet topology and an NE2000™ LAN driver, you would copy the following files:

- ◆ NE2000.LAN from the NW411\LANDRV subdirectory
- ◆ MSM.NLM and ETHERTSM.NLM from the NW411\LANDRV\CORE subdirectory

Install Files and Configure the New Server

Follow the procedures below to install the files on the new server, and to prepare the new server for remote installation from the DOS client.

Procedure

Procedure



1. **On each new server, create a new directory and name it “NWSERVER.”**
2. **Change to the NWSERVER subdirectory.**
3. **Insert the diskettes into the server diskette drive and copy the files that you copied in Step 3 on page 241 to the NWSERVER directory.**

4. **Type**

```
SERVER <Enter>
```

You are prompted to enter a server name.

5. **Enter a name for this server and press <Enter>.**

You are prompted for an IPX internal network number.

6. **Enter a an IPX internal network number and press <Enter>.**

7. **(Conditional) If you are installing through an SPX connection (rather than through a modem), load your LAN driver.**

For example, to load the NE2000 LAN driver, you would type:

```
LOAD NE2000 <Enter>
```

You are prompted for the I/O port number.

8. **(Conditional) If you are installing through an SPX connection, type the LAN driver I/O port number.**

For example, if your LAN driver is configured for I/O port 300, you would type:

```
300 <Enter>
```

- 9. (Conditional) If you are installing through an SPX connection, type the LAN driver interrupt.**

For example, if your LAN driver is configured for interrupt 3, you would type:

```
3 <Enter>
```

- 10. (Conditional) If you are installing through an SPX connection, bind the protocol to the LAN driver.**

For example, for an IPX™ protocol and an NE2000 LAN driver, you would type:

```
BIND IPX NE2000 NET=IPX external network number
<Enter>
```

- 11. Load the communications protocol.**

For example, if your new server is connected to the DOS client via a LAN, or a WAN fiber optic link, you would load the RSPX communications protocol. Type:

```
LOAD RSPX <Enter>
```

If your new server is connected to the DOS client via a modem, you would load the RS-232 communications protocol. Type:

```
LOAD RS232 <Enter>
```

After loading the communications protocol, you are prompted for a remote console password.

- 12. Type a remote console password and press <Enter>.**

This password will be used by the DOS client to establish a remote connection.

Configure the DOS Client and Install the Server

Follow the procedures below to configure your DOS client to communicate with the new server and then copy the NetWare 4.11 system files.

Procedure

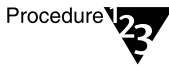

1. **At the DOS client, load the Link Support Layer by typing:**

`LSL <Enter>`

2. **Load your LAN driver.**

For example, to load the NE2000 LAN driver, type:

`NE2000 <Enter>`

3. **Load IPXODI by typing:**

`IPXODI <Enter>`

4. **Insert the *NetWare 4.11 Operating System* CD-ROM.**

5. **Change to the desired language subdirectory under the `INSTALL` directory.**

For example, if the CD-ROM drive were drive D:, the path would be:

`D:\NW411\INSTALL\LANGUAGE`

6. **Type**

`RCONSOLE <Enter>`

The “Connection Type” menu appears.

7. **From the “Connection Type” menu, select the applicable connection type and press <Enter>.**

For example, if you were connected to the new server via a LAN, you would select “SPX.”

The “Available Servers” menu appears.

8. **Highlight the server name you entered in Step 5 on page 243 and press <Enter>.**

You are prompted for a password.

9. **Enter the remote console password you entered in Step 12 on page 244 and press <Enter>.**
10. **Load INSTALL.NLM with the command line option as shown below by typing**

```
LOAD INSTALL -so <Enter>
```

This command line option invokes the “Server Options” and allows you to install or upgrade the server. The following menu appears:

Figure F-1
The “Installation Options” Menu

Installation Options	
Driver options	(load/unload disk and network drivers)
Disk options	(configure/mirror/test disk partitions)
Volume options	(configure/mount/dismount volumes)
License option	(install the server license)
Copy files option	(install NetWare system files)
Directory options	(install NetWare Directory Services)
NCF files options	(create/edit server startup files)
Multi CPU options	(install/uninstall SMP)
Product options	(other optional installation items)
Server options	(install/upgrade/this server)
Exit	

11. **Choose “Server Options” and press <Enter>.**
The “Server Installation Options” menu appears.
12. **From the “Server Installation Options” menu, choose “Install a New 4.11 Server” and press <Enter>.**
An information screen appears which, in this case, is not applicable.
13. **Press <Enter> to continue.**

A screen appears indicating the default path from which NetWare 4.11 files will be installed.

14. Press <F4> to select a remote client as the source.

A screen appears for you to enter the path to the remote client.

15. Enter the path to the CD-ROM drive of the DOS client.

For example, if the CD-ROM drive were drive D:, the path would be:

```
D:\nw411\INSTALL\LANGUAGE <Enter>
```

16. Continue the installation by following the procedures under “Load the Device Drivers” on page 70 in the “Custom Installation” chapter.



Since the LAN driver is already loaded and bound, when prompted for the LAN driver, press <F10> to skip that procedure and continue.

Understanding Driver Architecture

In earlier versions of NetWare 4™, a single disk driver (a .DSK file) served as the single interface between the NetWare operating system and all devices on the interface adapter. This is known as *monolithic architecture*.

NetWare® 4.11 introduces NetWare Peripheral Architecture™ (NWPA), which diverts the disk driver interface responsibilities to two new modules: a Host Adapter Module (HAM) and a Custom Device Module (CDM).

You can install your NetWare 4.11 server using either the traditional monolithic architecture (which uses the .DSK drivers) or the NWPA. For a quick overview of the advantages and disadvantages of using monolithic architecture and NWPA, see the table below.

**Table G-1
Disk Driver Architecture Overview**

Architecture Type	Advantages	Disadvantages
Monolithic (.DSK)	<p>Has been around much longer.</p> <p>Individual drivers have been tested for compatibility by both Novell and third-party manufacturers.</p>	<p>Requires a compliant driver to run all hardware devices connected to the adapter.</p> <p>Will not be released after 1/97. Will not be supported after 1/98.</p>
NetWare Peripheral Architecture (NWPA)	<p>Each hardware device connected to the adapter uses an individual CDM, which makes it better designed for scalability.</p> <p>Will be the principle disk driver architecture in future releases of NetWare.</p>	

For a detailed discussion of each architecture type, read the following sections and determine the driver architecture you want before loading your device or LAN drivers.

Monolithic Architecture

As stated earlier, monolithic architecture uses a single disk driver (a .DSK file) as the single interface between the NetWare operating system and all devices on the interface adapter.

You can use this architecture, if the disk driver supports all connected hardware devices.

Besides Novell® drivers, additional third-party drivers are also included with NetWare 4.11.



If you experience problems with third-party drivers, contact the manufacturer listed in the driver description that appears as you highlight the driver.

NetWare Peripheral Architecture (NWP)

NWP allows for broader driver support for host bus adapters and connected hardware devices.

The main advantage of using NWP over monolithic architecture is that NWP is better designed for scalability.

NWP separates NetWare driver support into two components: a Host Adapter Module (HAM) and a Custom Device Module (CDM). The HAM is the component used to drive the host bus adapter hardware. The CDM is the component used to drive hardware devices attached to a host adapter bus.

When you want to connect a new hardware device to the host bus adapter, you need to load only the appropriate CDM for that hardware device (in addition to the HAMs and CDMs already loaded), not a compatible disk driver to run *all* hardware devices connected to the adapter.

HAMs and CDMs are loaded the same way you load other disk drivers. The difference is that you load a HAM for the adapter in your server, and a CDM for each device type attached to the adapter.

When the first HAM is loaded, the NWPA.NLM is loaded automatically. NWPA.NLM is an interface between the NWPA and the Media Manager. The Media Manager provides a storage management interface between applications and storage device drivers.

Once the HAM and NWPA.NLM are loaded, the server is scanned for new devices. Based on what new devices are found, the appropriate Novell CDMs are then loaded. Standard Novell CDMs are listed in Table G-2.

Table G-2
Novell NWPA Disk Drivers, HAMs, and CDMs

Computer architecture	Controller	HAM you must load	Novell CDM that is loaded
Industry Standard Architecture (ISA)	AT class IDE (ATA)	IDEATA.HAM	IDEHD.CDM (For a hard disk)
	Adaptec 154X	SCSI154X.HAM	SCSIHD.CDM (For a hard disk) SCSICD.CDM (For a CD-ROM drive) SCSIMO.CDM (For a magneto-optical drive) SCSI2TP.CDM (For a tape device)
Extended Industry Standard Architecture (EISA)	AT class IDE (ATA)	IDEATA.HAM	IDEHD.CDM (For a hard disk)
	Adaptec 154X	SCSI154X.HAM	SCSIHD.CDM (For a hard disk) SCSICD.CDM (For a CD-ROM drive) SCSIMO.CDM (For a magneto-optical drive) SCSI2TP.CDM (For a tape device)
	EISA vendor proprietary	See vendor	See vendor

If you are using a third-party CDM, rather than one of the Novell standard CDMs, it might be autodetected. If not, it must be loaded manually.

A description of NetWare 4.11 HAMs and CDMs appears on the screen as you highlight the driver.

For more information about the NWPA, refer to “NetWare Peripheral Architecture” in *Concepts*.

Red Box CD-ROM Drivers

The following list defines the CD-ROM drivers and their load order needed to enable a CD-ROM device to mount a CD-ROM as a NetWare[®] volume.

The list may or may not be complete, as drivers may have been added to the Novell[®] Red Box[™] (NetWare 4.11 product package) after the list was created.

An updated list can be obtained via Novell's faxback server by calling 1-800-NETWARE and requesting document #1344.

Please note that this list simply defines the load order of drivers included in the Red Box. The configurations listed may not work in every possible hardware configuration. Novell has made every effort to ensure the accuracy of the document and the information contained herein.

Table H-1
Red Box CD-ROM Drivers and Load Order

Manufacturer	Adapter	Driver load order
Adaptec	AHA-1510A	AHA1510.DSK
		ASPITRAN.DSK
		ASPICD.DSK
		NWPA.NLM
		CDROM.NLM

Table H-1 *continued*

Red Box CD-ROM Drivers and Load Order

Manufacturer	Adapter	Driver load order
Adaptec	AHA-1522A	AHA1520.DSK
		ASPITRAN.DSK
		ASPICD.DSK
		NWPA.NLM
		CDROM.NLM
Adaptec	AHA-1542CF	AHA1540.DSK
	AHA-174xAS6*	ASPITRAN.DSK
	AHA-174xAS200*	ASPICD.DSK
	AHA-174xA*	NWPA.NLM
	*Standard Mode	CDROM.NLM
Adaptec	AHA-1640S6	AHA1640.DSK
		ASPITRAN.DSK
		ASPICD.DSK
		NWPA.NLM
		CDROM.NLM
Adaptec	AHA-1742AS6*	AHA1740.DSK
	AHA-174xAS6*	ASPITRAN.DSK
	AHA-174xAS200	ASPICD.DSK
	AHA-174xA*	NWPA.NLM
	*Enhanced Mode	CDROM.NLM

Table H-1 *continued*

Red Box CD-ROM Drivers and Load Order

Manufacturer	Adapter	Driver load order
Adaptec	AHA-2742A	AIC7770.DSK
	AHA-2742A-T	ASPITRAN.DSK
	AHA-2742T	ASPICD.DSK
		NWPA.NLM
		CDROM.NLM
Always	IN-2000	IN2000.DSK
		ADAASPI.DSK
		NWPA.NLM
		CDROM.NLM
Always	AL-6000	AL6000.DSK
		ADAASPI.DSK
		NWPA.NLM
		CDROM.NLM
Always	AL-7000	AL7000.DSK
		ADAASPI.DSK
		NWPA.NLM
		CDROM.NLM
Buslogic	BT-542/545	BT4X.DSK
	BT-640/646	NWPA.NLM
	BT-742/747	CDROM.NLM
	BT-445S	
	BT-946C	

Table H-1 *continued*

Red Box CD-ROM Drivers and Load Order

Manufacturer	Adapter	Driver load order
DPT	PM2012B	PM12NW40.DSK
	PM2022/9X	NWPA.NLM
	PM2122/9X	CDROM.NLM
DPT	PM2011B	PM11NW40.DSK
	PM2021/9X	NWPA.NLM
		CDROM.NLM
DTC	DTC 3290	DTC90AS4.DSK
		DTC90HD4.DSK
		ASPICD.DSK
		NWPA.NLM
		CDROM.NLM
DTC	DTC 3280	DTC80AS4.DSK
		DTC80HD4.DSK
		ASPICD.DSK
		NWPA.NLM
		CDROM.NLM
Future Domain	TMC-16XX	SIM18_4.DSK
	MCS-600/700	FUTXPT.DSK
	TMC3260	FUTD_4.DSK
		NWPA.NLM
		CDROM.NLM

Table H-1 *continued***Red Box CD-ROM Drivers and Load Order**

Manufacturer	Adapter	Driver load order
Future Domain	TMC-8XX	SIM950_4.DSK
		FUTXPT.DSK
		FUTD_4.DSK
		NWPA.NLM
		CDROM.NLM
Mylex	DAC960-3	DACNET4.DSK
	DAC960-5	ASPIDAC.DSK
		ASPICD.DSK
		NWPA.NLM
		CDROM.NLM

Trademarks

Novell Trademarks

Certified Novell Engineer is a service mark of Novell, Inc.

Client 32 is a trademark of Novell, Inc.

Hot Fix is a trademark of Novell, Inc.

Internetwork Packet Exchange and IPX are trademarks of Novell, Inc.

LANalyzer is a registered trademark of Novell, Inc. in the United States and other countries. in the United States and other countries.

Link Support Layer and LSL are trademarks of Novell, Inc.

ManageWise is a registered trademark of Novell, Inc.

MSL (Mirrored Server Link) is a trademark of Novell, Inc.

Multiple Link Interface Driver and MLID are trademarks of Novell, Inc.

NE/2 is a trademark of Novell, Inc.

NE/2-32 is a trademark of Novell, Inc.

NE1000 is a trademark of Novell, Inc.

NE2000 is a trademark of Novell, Inc.

NE2100 is a trademark of Novell, Inc.

NE3200 is a trademark of Novell, Inc.

NetWare is a registered trademark of Novell, Inc. in the United States and other countries.

NetWare 4 is a trademark of Novell, Inc.

NetWare 4.1 SFT III, NetWare 4.11 SFT III, and SFT III are trademarks of Novell, Inc.

NetWare Care is a trademark of Novell, Inc.

NetWare Client is a trademark of Novell, Inc.

NetWare/IP is a trademark of Novell, Inc.

NetWare Loadable Module and NLM are trademarks of Novell, Inc.

NetWare Peripheral Architecture is a trademark of Novell, Inc.

NetWare Ready is a trademark of Novell, Inc.

NetWire is a registered service mark of Novell, Inc.

Network Support Encyclopedia is a service mark of Novell, Inc.

Network Support Encyclopedia Professional Volume is a service mark of Novell, Inc.

Novell is a registered trademark of Novell, Inc. in the United States and other countries.

Novell Application Notes is a trademark of Novell, Inc.

Novell Authorized Reseller is a service mark of Novell, Inc.

Novell Authorized Service Center and NASC are service marks of Novell, Inc.

Novell Directory Services and NDS are trademarks of Novell, Inc.

Novell Labs is a trademark of Novell, Inc.

Novell Press is a registered trademark of Novell, Inc. in the United States and other countries.

Novell Research Reports is a trademark of Novell, Inc.

Novell Technical Support is a service mark of Novell, Inc.

NTR2000 is a trademark of Novell, Inc.

ODI (Open Data-Link Interface) is a trademark of Novell, Inc.

Packet Burst is a trademark of Novell, Inc.

Personal NetWare is a trademark of Novell, Inc.

Red Box is a trademark of Novell, Inc.

RX-Net is a trademark of Novell, Inc.

SPX is a trademark of Novell, Inc.

The Novell Network Symbol is a trademark of Novell, Inc.

Transaction Tracking System and TTS are trademarks of Novell, Inc.

VLM (Virtual Loadable Module) is a trademark of Novell, Inc.

Yes, It Runs with NetWare Logo is a certification mark of Novell, Inc.

Yes, NetWare Tested and Approved Logo is a certification mark of Novell, Inc.

Third-Party Trademarks

3Com and 3+Share are registered trademarks of 3Com Corporation.

Apple, AppleShare, and AppleTalk are registered trademarks of Apple Computer, Inc.

ARCnet is a registered trademark of Datapoint Corporation.

COMPAQ is a registered trademark of Compaq Computer Corporation.

CompuServe is a registered trademark of CompuServe, Inc.

DynaText is a registered trademark of Electronic Book Technologies, Inc.

IBM is a registered trademark of International Business Machines Corporation.

Macintosh is a registered trademark of Apple Computer, Inc.

Micro Channel is a registered trademark of International Business Machines Corporation.

NFS is a registered trademark of Sun Microsystems, Inc.

OS/2 is a registered trademark of International Business Machines Corporation.

Pentium is a trademark of Intel Corporation.

QEMM 386 is a trademark of Quarterdeck Office Systems.

TokenLink is a registered trademark of 3Com Corporation.

XT is a trademark of International Business Machines Corporation.

Index

80386 microprocessor restrictions, explained
12

A

Adding

- commands to AUTOEXEC.NCF file 129
- commands to STARTUP.NCF file 126
- name space to volume 88
- RAM for cache buffers 14

ADMIN User object

- created during server installation 52, 121
- default trustee assignments for 52, 122

Administrator

- default created during installation 52
- default object created during installation
121
- password 44, 121

Alternate MSL boards, installing 200, 204

Applications, third-party

- determining required RAM for 221

Assigning, IPX internal network number 65

AUTOEXEC.NCF file

- adding SET commands to 129
- editing, during installation 127
- information saved in 127
- viewing 127

B

Bindery context, established during server
installation 128

Block

- size (volume), modifying default 92
- suballocation, enabling/disabling 95

Boot files, copying 30, 65

C

Cache buffers, adding additional to RAM 14

Card, LAN. *See* Network board

CDM. *See* Custom Device Module (CDM)

CD-ROM

- creating client diskettes from 235
- drivers included in Red Box 253
- drivers, load order 253
- installing NetWare Server for OS/2 from
146
- installing server from 17
- mounted as NetWare volume 148

Client

- diskettes, creating 55, 138
- diskettes, creating from CD-ROM 235

Code page, specifying 66

Commands

- adding to STARTUP.NCF file 126
- deleting from STARTUP.NCF file 124
- LOAD, adding to AUTOEXEC.NCF file
129

- LOAD, adding to STARTUP.NCF file 126
- MOUNT, using in AUTOEXEC.NCF file 129
- PAUSE, adding to STARTUP.NCF file 126
- PAUSE, using in AUTOEXEC.NCF file 129
- SECURE CONSOLE, using in
 - AUTOEXEC.NCF file 129
- SET, adding to AUTOEXEC.NCF file 129
- SET, adding to STARTUP.NCF file 126
- Company name, entering during installation 119
- Configuration
 - information, copying to *Registration* diskette 55, 133
 - SFT III files, explained 208
- Configuring
 - network protocols 134
- Console
 - displays, change SFT III 212
 - title bar, displaying in SFT III 212
- Container object, default trustee assignments
 - created during installation 53, 122
- Context
 - bindery, created during server installation 128
 - server, setting 117
- Coordinated Universal Time (UTC),
 - specifying offset from 114
- Copying
 - configuration information to *Registration* diskette 55, 133
 - files for installing using RCONSOLE 241
 - files to NetWare disk partition 29, 65
 - server boot files 30, 65
 - system files to volume SYS: 50, 103
- Country codes
 - listed 229
 - possible problems using 119
 - specifying 119
- CPU

- dual processing with two 212
- requirements for SFT III servers 197
- Creating
 - client diskettes 138
 - files (*see specific filename*)
 - NetWare disk partition 39, 79
- Custom Device Module (CDM), explained 250
- Custom Directory tree, installing into 47, 49, 117
- Custom installation, explained 59. *See also* Installation

D

- Data
 - failure protection, with duplexing 83
 - migration to storage device, enabling/disabling 96
- Daylight saving time, setting 116
- Default trustee assignments, created during installation 52, 122
- Deleting
 - commands in AUTOEXEC.NCF file 129
 - commands in STARTUP.NCF file 126
- DET ratios, and name spaces 224
- DET. *See* Directory Entry Table
- Device drivers, loading 31
- Directory Entry Table (DET)
 - tracking memory in 92
- Directory Services. *See* Novell Directory Services (NDS)
- Directory tree
 - choosing from multiple 48, 111
 - first NetWare 4 server in 43, 107
 - illustrated 122
 - installing into custom tree 47, 49, 117
 - nonlocatable, or first server 108
 - simple, illustrated 52
 - specifying name of 108

- Disabling/enabling
 - block suballocation 95
 - data migration to storage device 96
 - file compression 93
- Disk drivers. *See also* LAN drivers
 - DSKSHARE, using in NetWare Server for OS/2 171
 - Monolithic Architecture 250
 - NetWare Peripheral Architecture (NPA) 250
 - Novell, listed 33, 71, 251
- Disk partition, NetWare
 - creating 39
 - illustrated 40
- Diskettes
 - creating client 55, 138
 - creating Upgrade/Migrate 55, 138
 - Registration*, copying configuration information to 55, 133
- DMA board, restrictions 14
- DOS
 - filename format, explained 62, 67
 - version required for SFT III servers 197
- Drivers, listed
 - disk 33, 71
 - LAN 35, 74
- Dual processing
 - dual-processor driver required for 212
 - implement in SFT III 212
- Duplexing NetWare disk partitions. *See* NetWare disk partition

E

- Editing
 - AUTOEXEC.NCF file during installation 127
 - STARTUP.NCF file during installation 124
- Enabling/disabling
 - block suballocation 95

- data migration to storage device 96
- file compression 93

F

- Failure, protecting data against 83
- FAT. *See* File Allocation Table
- FDISK, using to repartition the hard disk 12
- File Allocation Table, tracking memory in 92
- File compression, enabling/disabling 93
- Files. *See also* specific filename
 - copying, during installation 22
 - names, creating separate volumes for long 88
 - server boot, copying 65
 - server configuration (*see* SFTIII server, configuration files)
 - system, copying during installation 103
- FORMAT, using to format a hard disk partition 12

H

- HAM. *See* Host Adapter Module (HAM)
- Hard disk, server
 - FDISK, using to repartition 12
 - FORMAT, using to format a disk partition 12
 - maximum allowable space on 14
 - minimum size for new installation 13
 - protecting data against failure of 83
- Hardware requirements
 - installing locally or over the network 15
 - installing NetWare Server for OS/2 143
 - installing SFT III 197
 - installing using RCONSOLE 240
- High-speed link. *See* Mirrored Server Link (MSL)
- Host Adapter Module (HAM), explained 250

Hot Fix Redirection Area, modifying size of
82

saved in AUTOEXEC.NCF file 128
specifying for SFT III 202

I

INETCFG.NLM, using to configure protocols
INSTALL.NLM

editing SFT III configuration files with 210

Installation

assumptions made in custom 59

assumptions made in simple 25

options, described viii

trustee assignments created during 53

Installing

NetWare 4.11 from a local CD-ROM 17

NetWare 4.11 from a remote network area
18

NetWare Client for OS/2 173

NetWare for Macintosh 133

NetWare license 50, 124

new server into an existing Directory tree
46

Novell Directory Services 42

server software 26

SFT III 197

using RCONSOLE 239

Installing NetWare 4.11 worksheet 141

Interrupts, assigning for MSL boards 200

IOAUTO.NCF file

editing 211

sample 211

IOEngine

configuration files, explained 210

console display, viewing 212

naming 202

IOSTART.NCF file

editing 210

sample 210

IPX internal network number

assigning 65

K

Keyboard, lockup 32, 39, 71, 79

L

LAN drivers. *See also* Disk drivers

explained 35, 73

loading 35

loading in NetWare Server for OS/2 167

Novell, listed 35, 74

Language configuration screen, illustrated 66

Language, server

changing 136

install an additional 136

LANSHARE.LAN, using for network board

sharing 160, 171

License, installing NetWare 50, 124

LOAD, adding to AUTOEXEC.NCF file 129

LOAD, adding to STARTUP.NCF file 126

Loading

name spaces 126

M

MacNDS client, preparing for installation 237

MacNDS.SEA file, extracting 237

MAKEDISK utility, using to create client

diskettes 236

Memory requirements

for NetWare 4.11 12

for SFT III servers 198

Microprocessor, restrictions 15

Mirroring NetWare disk partitions. *See*

NetWare disk partition

- Modem, installing using RCONSOLE 239
- Modifying
 - AUTOEXEC.NCF file 127
 - default volume block size 92
 - Hot Fix Redirection Area size 82
- Monitor board, requirements for SFT III servers 198
- Monolithic Architecture, explained 250
- MOUNT command, in AUTOEXEC.NCF file 129
- Mounting volumes. *See* Volumes 126
- Mounting, CD-ROM as a NetWare volume 39, 79
- MSAUTO.NCF file, editing 211
- MSEngine
 - console display, viewing 212
 - naming 202
- MSL boards
 - alternate, installing 200, 204
 - drivers, loading 204
 - installing 200
 - interrupts, assigning 200
- MSSTART.NCF file, editing 212

N

- Name space, adding LOAD command to STARTUP.NCF file 126
- Name spaces
 - RAM requirements for 223
 - RAM tuning strategies 225
- NCF files for SFT III, explained 208
- NDS context, specifying 118
- NetWare Client for OS/2, installing 173
- NetWare disk partition. *See also* DOS disk partition
 - copying files to 39
 - copying NetWare 4.11 files to 103
 - creating 39, 79
 - duplexing 83
 - illustrated 40, 80
 - mirroring 83
 - out-of-sync, accessing 84
 - specifying size of 81
- NetWare for Macintosh, installing 133
- NetWare Loadable Module
 - adding, to AUTOEXEC.NCF file 129
 - loading 4.11 INSTALL, during installation 68
- NetWare Peripheral Architecture (NPA), explained 250
- NetWare server
 - installing first server in Directory tree 43
 - installing license 50, 124
 - type, choosing time 113
- NetWare Server for OS/2
 - changing network board sharing configurations 185
 - hardware requirements for 143
 - loading LAN drivers 167
 - network board sharing 158
 - overview 143
 - prerequisites for installing 144
 - software requirements 144
 - upgrading 181
- NetWare Server for OS/2, drivers
 - DSKSHARE.DSK 171
 - LANSHARE 160, 171
 - ODINSUP 162
 - TOKENLNK 171
 - TOKENSHR 159, 171
- NetWare Server for OS/2, installing
 - from a CD-ROM mounted as a volume 148
 - from a NetWare volume 151
 - from CD-ROM 146
 - from remote network installation area server software, prerequisites 144
 - using the custom option 156
 - using the simplified option 153

- NetWare server object, created during server installation 121
- NetWare SMP, installing 30
- NetWare volume, mounting CD-ROM as a 39
- Network board
 - listed 73
 - loading 73
 - sharing (*see* NetWare Server for OS/2)
- NLM. *See* NetWare Loadable Module
- Novell Directory Services (NDS)
 - context, server (*see* Server context)
 - installing 105
- Novell drivers, listed
 - disk 33, 71
 - HAMs and CDMs 251
 - LAN 35, 74
- NPA. *See* NetWare Peripheral Architecture (NPA)

O

- Object
 - [root], created during server installation 118
 - created during installation 52
 - default trustee assignments 52
 - server, created during installation 121
 - volume, created during server installation 87
 - volume, explained 87
- ODINSUP
 - setting up for network board sharing 162
- Offset, specifying
 - for daylight saving time 116
 - from Coordinated Universal Time (UTC) 114
- Online documentation
 - disk space necessary for 13
- Organization name, entering 44, 119

P

- Parameters, setting
 - server, in AUTOEXEC.NCF file 129
 - server, in STARTUP.NCF file 126
- PAUSE command, adding
 - to AUTOEXEC.NCF file 129
 - to STARTUP.NCF file 126
- Prerequisites. *See also* Hardware requirements; Software requirements
 - for installing NetWare Server for OS/2 144
 - for installing SFT III 200
 - NetWare server installation 11
 - upgrading from SFT III 3.11 and 4.1 213
- Processor. *See* Microprocessor
- Product registration, filling out 54, 132
- Protecting against data failure 83
- Protocols, configuring 134
- [Public] trustee, default trustee assignments
 - created during server installation 52

R

- RAM requirements
 - maximum allowed in server 14
 - SFT III servers 198
- RAM, calculating
 - block suballocation requirements 220
 - core operating system requirements 220
 - file compression requirements 220
 - requirements for name spaces 223
 - server applications requirements 221
- RCONSOLE, install using 239
- Red Box, CD-ROM drivers included in 253
- Redirection Area Hot Fix, modifying size of 82
- Registration information, filling out 54, 132
- Remote network installation area, installing NetWare Server for OS/2

Remote network installation, explained 18
Rights, assigned during installation 52

S

SAP filtering 46
Security defaults, created during installation 52, 122
Server
 boot files, copying 30
 installing, software 60
 object, created during installation 121
 object, created during server installation 52
Server context. *See also* Context
 country codes used in 229
 example 117
Server context. *See also* Context
 explained 117
Server RAM, calculating 14
Server software, installing 26
Server-to-server session, establishing 41, 103
SET commands
 adding to AUTOEXEC.NCF file 129
 adding to STARTUP.NCF file 126
SFT III server
 configuration files, explained 209
 displaying console screens 212
 install 201
 prerequisites for installing 200
 upgrading from 3.11 to 4.11 213
Sharing a network board. *See* NetWare Server for OS/2
Simple installation, assumptions 25
SMP. *See* Symmetric MultiProcessing
Software requirements
 for installing NetWare Server for OS/2 144
 for installing under DOS or Windows 22
 for SFT III 198
Standard time, setting 113

STARTUP.NCF file
 executing 124
 information saved in 124
 viewing 124
Suballocation, block enabling/disabling 95
Supervisor
 password 44
 User object, created 121
 user object, created 52
Supervisor object right, created during installation 52
Symmetric MultiProcessing (SMP), explained 30
System files, copying to volume SYS: 50

T

Time server type, choosing 113
Time zone information
 abbreviation for daylight saving time 116
 abbreviation for standard time 114
 offsets from UTC, illustrated 115
 saved in AUTOEXEC.NCF file 128
Title bar for SFT III console, displaying 212
TOKENLNK.LAN, using for network board sharing 160, 171
TOKENSHR.LAN, using for network board sharing 159, 171
Troubleshooting
 country codes 120
Trustee assignments
 defaults created during server installation 52
Type, time server choosing 113

U

Upgrade 3.1x Print Services 133

- Upgrade from SFT III 3.11 and 4.1 to SFT III 4.11 213
- Upgrade/Migrate diskettes, creating 55, 138
- Upgrading NetWare Server for OS/2 181
- User object, Admin
 - created during server installation 52
 - password 52
- User object, Supervisor in bindery-based installations 52. *See also* Supervisor
- User objects, default trustee assignments during installation 53, 123
- UTC. *See* Coordinated Universal Time

V

- Volume object
 - created during server installation 52, 121
 - explained 87
- Volume SYS:, copying system files to 50, 103
- Volumes
 - appearance in Directory tree 87
 - creating separate, for long filenames 88
 - creating, suggestions for 88
 - modifying default block size 89
 - modifying name 87, 90
 - mounting during installation 98, 126

W

- Worksheet, server installation 141
- World time zones, offsets from UTC (illustrated) 115

Y

- Yes program, certification criteria 13

User Comments

We want to hear your comments and suggestions about this manual. Please send them to the following address:

Novell, Inc.
Documentation Development
MS C-23-1
122 East 1700 South
Provo, UT 84606
U.S.A
Fax: (801) 861-3002

IntranetWare
NetWare 4 Installation
Part #100-003600-001 A
May 1997

For technical support issues, contact your local dealer.

Your name and title: _____

Company: _____

Address: _____

Phone number: _____ Fax: _____

I use this manual as an overview a tutorial a reference a guide _____

	Excellent	Good	Fair	Poor
Completeness	<input type="checkbox"/>	<input type="checkbox"/>	<input type="checkbox"/>	<input type="checkbox"/>
Readability (style)	<input type="checkbox"/>	<input type="checkbox"/>	<input type="checkbox"/>	<input type="checkbox"/>
Organization/Format	<input type="checkbox"/>	<input type="checkbox"/>	<input type="checkbox"/>	<input type="checkbox"/>
Accuracy	<input type="checkbox"/>	<input type="checkbox"/>	<input type="checkbox"/>	<input type="checkbox"/>
Examples	<input type="checkbox"/>	<input type="checkbox"/>	<input type="checkbox"/>	<input type="checkbox"/>
Illustrations	<input type="checkbox"/>	<input type="checkbox"/>	<input type="checkbox"/>	<input type="checkbox"/>
Usefulness	<input type="checkbox"/>	<input type="checkbox"/>	<input type="checkbox"/>	<input type="checkbox"/>

Please explain any of your ratings: _____

In what ways can this manual be improved? _____

You may photocopy this comment page as needed so that others can also send in comments.

