

MDP3858U Series
MDP3858UE Series

PCI 56K MODEM

User's Manual

Version 1.0

Contents



	Preface	4
Chapter 1	Introduction	5
Chapter 2	Before you begin	6
	2.1 Minimum System Requirements	6
	2.2 Safety Precaution	6
	2.3 Installation Notes	7
Chapter 3	Setting Up the Modem Card	8
	3.1 Installing the Modem Card	8
	3.2 Connecting the Modem Card	11
Chapter 4	Installing the Modem Drivers	14
	4.1 For Windows® 95	14
	4.2 For Windows® 98	17
	4.3 For Windows NT® 4.0	19
Chapter 5	Testing the Modem Card	20
	5.1 For Windows® 95/98	20
	5.2 For Windows NT® 4.0	23

Appendix A	Frequently Asked Questions	24
	A.1 Technical Terms	24
	A.2 Common Questions	25
Appendix B	Technical Specifications	32
Appendix C	TAD Connection	34

Preface

*This manual covers the models **MDP3858SP-U**, **MDP3858V-U** and **MDP3858-U** for **MDP3858U** series as well as **MDP3858SP-UE**, **MDP3858V-UE** and **MDP3858-UE** for **MDP3858UE** series.*

This manual gives you a step-by-step guide of the following:

1. Installation of your modem card to your computer
2. Connection to the phone line for internet
3. Installation of modem drivers required to run the modem
4. Testing of the modem

The section - ***Frequently Asked Questions (FAQ)*** will explain some of the technical terms used in this manual, as well as the possible solutions for some of the commonly asked questions by users.

For further technical details on your card, you may refer to the **ReadMe.txt** file found in your **MDP3858 Installation Disk/CD**.

Chapter 1



Introduction

Congratulations on your purchase of 56K PCI Modem!

With the 56K PCI Modem alone, you can perform a comprehensive range of modem-related functions including data communications, sending and receiving of faxes.

Depending on the model that you have bought, you can also do telephone / speakerphone operations.

The intensive demands of today's Internet applications will no longer be a bottleneck. Using the 56K PCI Modem, you can now download graphic intensive web pages, high bandwidth audio and video files as well as large file size software programs at speeds of up to 56Kbps.



Chapter 2



Before You Begin

This chapter contains information that you need to know before installing your modem card. They are the basic system requirements needed for your modem card to run, the safety rules to follow, as well as the installation guidelines.

2.1 Minimum System Requirements

- IBM PC-based computer with Pentium® 166 processor
- PCI Bus slot
- 16MB RAM
- 10MB hard disk space (system files and modem drivers only)
- CD-ROM drive
- Windows® 95/98 / NT®4.0

2.2 Safety Precaution

- Do not remove your card from its protective bag until you are ready to install it.
- Always try to hold your card by its edges. Avoid touching any electronic components on your card.
- Static electricity can cause permanent damage to your card. To prevent such a damage, you must ground yourself during the installation:



- » Use a grounding strap - a coiled wire with a clip at one end and an elastic strap at the other. Wear the strap around your wrist and attach the clip to any non-painted metal surface of your computer chassis.
- » If you do not have a grounding strap, touch any non-painted surface of your computer chassis before you begin installation, and again every minute or so until the installation is completed.

2.3 Installation Notes

- Computers come in different shapes and sizes. Therefore, the installation procedures in this manual apply generally and you should compare the illustrations here with your computer.
- A Philips screwdriver is required.
- The documentation for your computer should come in handy during the installation. Have it ready by your side.
- If you have an existing *non* Plug-and-Play modem installed in your computer, you must first un-install its modem drivers before you remove the card. Refer to the documentation of your existing modem for details.

If your existing modem is Plug-and-Play, you may proceed to install your new modem.

Chapter 3



Setting Up Your Modem Card

This chapter contains information on how to install the modem card and the telephone line to your computer.

3.1 Installing the Modem Card



You need to remove any existing modem installed in your computer. If your modem is non Plug-and-Play, you need to un-install its modem drivers before you remove it. Check your existing modem documentation for details on this.

Power off your computer and any connected devices before installing your modem!

- 1 Remove the cover of your computer.

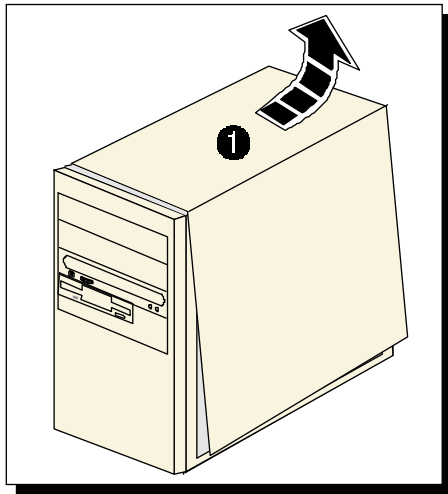

- 2 Select an available PCI Bus slot and remove its cover plate. Keep the mounting screw to secure your card later.

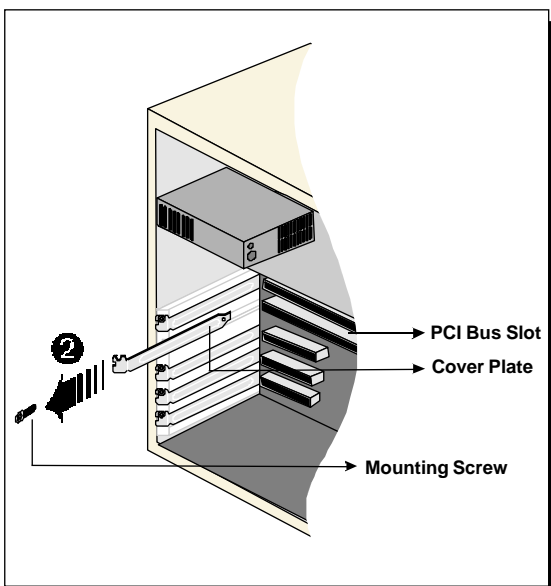

- 3 Align your card with the selected PCI Bus slot and firmly push it into the slot. If the card does not slide in, do not force it. Make sure that the card is lined up properly and try again.

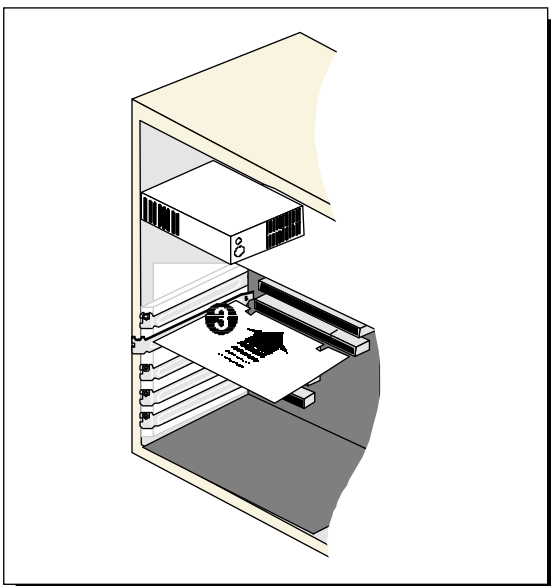

- 4 Secure your card to your computer chassis with the mounting screw.

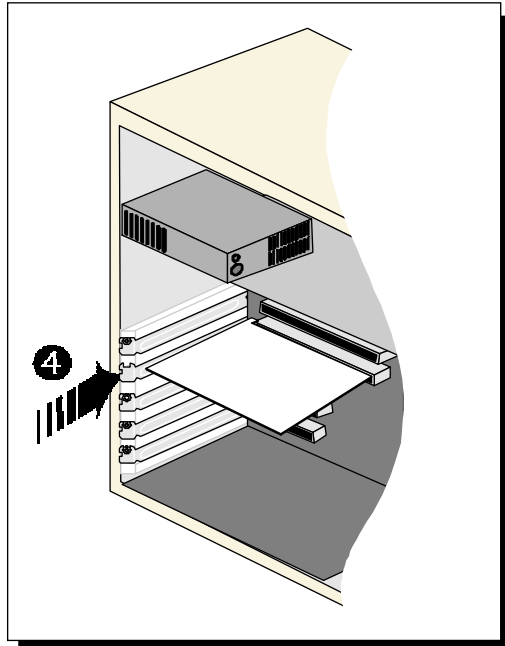

- 5 Replace the cover of your computer.

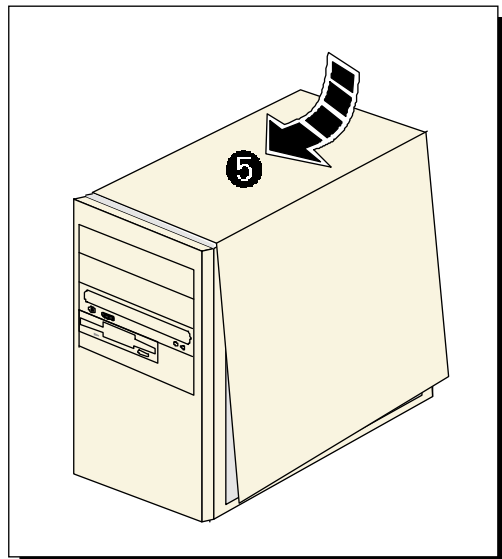

3.2 Connecting the Modem Card

3.2.1 For MDP3858V-U/V-UE, MDP3858-U/-UE users

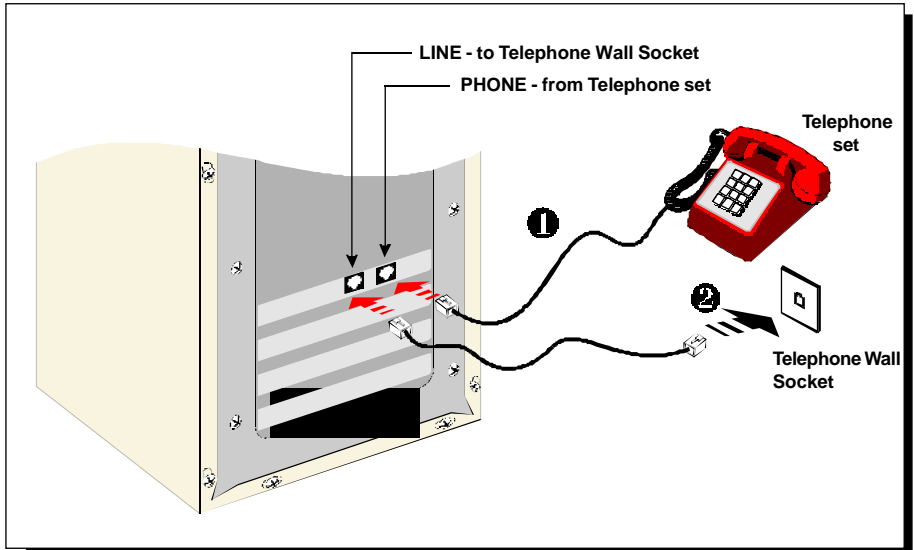

- 1 Connect a **telephone set** to the modem card.
(This optional connection eliminates the need to switch between your telephone set and your modem card if they are sharing the same telephone wall socket)
- 2 Connect one end of the **telephone extension cord** to the modem card and the other end to the **telephone wall socket**.

This completes the setting up of your modem. Please proceed to the next chapter to install your modem drivers.

3.2.2 For MDP3858SP-U/SP-UE users

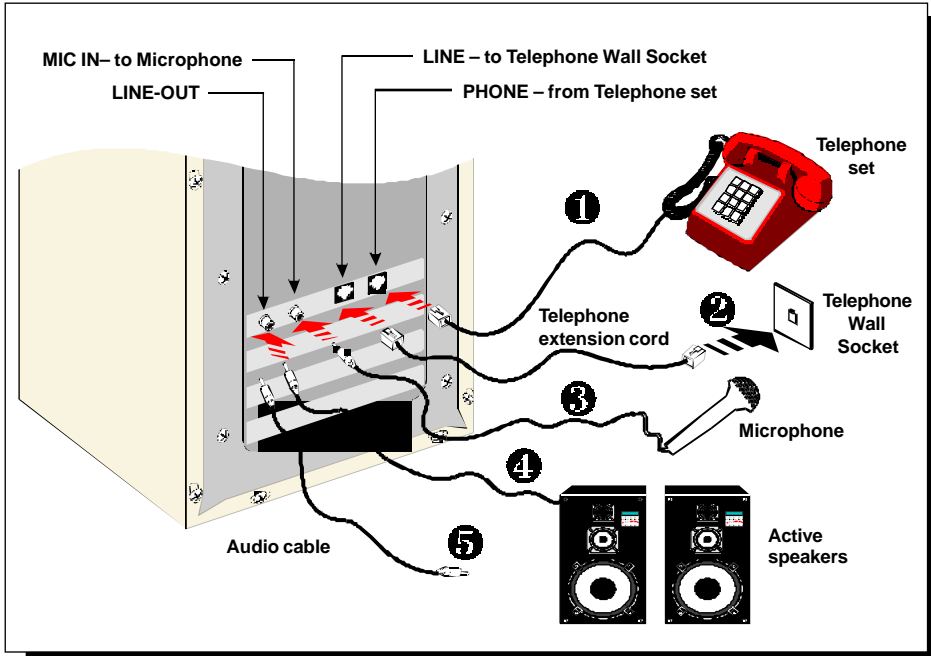

- 1 Connect a **telephone set** to the modem card.
(This optional connection eliminates the need to switch between your telephone set and your modem card if they are sharing the same telephone wall socket)
- 2 Connect one end of the **telephone extension cord** to the modem card and the other end to the **telephone wall socket**.
- 3 Connect a **microphone** to your modem card.
(This optional connection allows you to speak/sing over the microphone during speakerphone conversations)
- 4 Connect your **active speakers** to your modem card.
This connection is required to receive sound output from your modem card. Before you make use of this LINE-OUT jack, you need to run the **Set Audio Output Utility** to configure your modem's sound output from **Buzzer** to **Line-Out** option.

- i) From Windows taskbar, click **Start > Programs > MDP3858 Modem Information > Set Audio**.
- ii) From the dialog prompt, select **Line-Out**.

To configure back to buzzer, run the same utility again and click the **Buzzer** option.

- 5** Alternatively, if you have a **sound card** (with speakers attached), you may want to externally connect an **audio cable** from this **LINE-OUT jack of your modem card** to the **LINE-IN jack of your sound card**.

This connection is required if you want to do **voice playback**.

For **voice recording**, the **microphone** must be connected to the **MIC-IN Jack of your compatible sound card**.



Instead of using the audio cable, you may also use a TAD cable to internally connect your modem card and your compatible sound card as described in Appendix C - TAD Connection. For this connection, all devices (e.g. microphone, speakers) are to be connected to your sound card, regardless of voice recording or speakerphone.

This completes the setting up of your modem. Please proceed to the next chapter to install your modem drivers.

Chapter 4

Installing the Modem Drivers

This chapter contains information on how to install the modem drivers under Windows® 95/98 and Windows NT® 4.0.



If problems are encountered with connection or performance of this modem, please ensure that the country setting is correct for your location. In some cases, the country is set to match the Operating System selected and may need to be re-selected to match your exact location. For instructions on how to change the setting, refer to Appendix A - Frequently Asked Questions "I am using my system with the modem card in another country. Is there any settings that need to be changed ?".

4.1 For Windows® 95

1. Power on your computer to start Windows® 95.



Windows® 95 will detect the newly installed modem and an **Update Device Driver Wizard** window will appear.

Place your Installation CD/floppy disk into the CD-ROM drive/floppy disk drive.

Click **Next**.

- Windows® 95 will now prompt you that the modem drivers have been found.



Click **Finish** to continue with the installation.

- When the **Insert Disk** window appears, click **OK**.

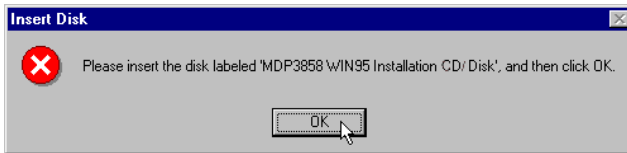

- The **Copying Files...** window will appear.

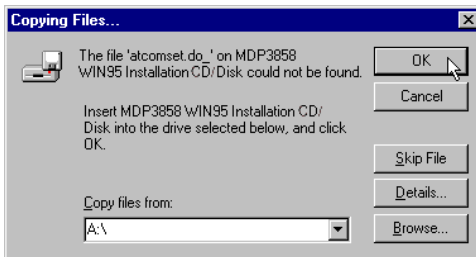

For drivers that are found in **CD**, in the **Run** text box, type "**D:**".
(Assuming your CD-ROM drive is **D**. If not, substitute drive letter accordingly)

For drivers that are found in **diskette**, in the **Run** text box, type "**A:**".
(Assuming your floppy disk drive is **A**. If not, substitute drive letter accordingly)

Click **OK**. Restart your system, if prompted.

This completes the installation of the modem drivers in Windows® 95. Proceed to the next chapter to test your modem.

4.2 For Windows® 98

1. Power on your computer to start Windows® 98. Windows® 98 will detect the newly-installed modem and an **Add New Hardware Wizard** window will appear.

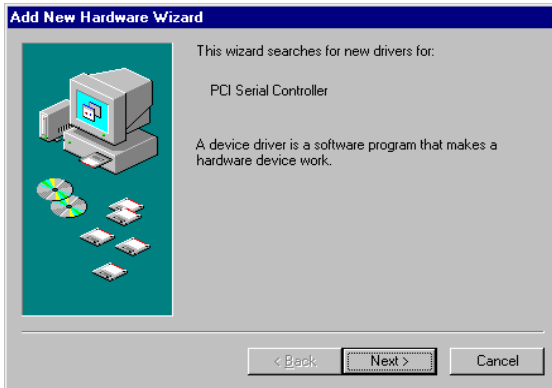

Place your Installation CD/floppy disk into the CD-ROM drive/floppy disk drive.

Click **Next**.

2. The next window prompt will ask for your modem drivers.



Click the option **'Search for the best driver for your device (Recommended).'**

Click **Next**.

- At the next prompt, select the source of your drivers.
If your drivers are found in **CD**, click the option '**CD-ROM drive**'.
If your drivers are found in **diskettes**, click the option '**Floppy disk drives**'.



Click **Next**.

- To start the drivers installation, click **Next** again.



- To complete the drivers installation, click **Finish** and restart your system, if prompted.

This completes the installation of the modem drivers in Windows® 98. Proceed to the next chapter to test your modem.

4.3 For Windows NT® 4.0

1. Start Windows NT®.
2. Place your Installation CD/floppy disk into the CD-ROM drive/floppy disk drive.
3. From the Windows NT® taskbar, select **Start > Run...** .

If your drivers are found in **CD**, in the **Run** text box, type:

"D:\WinntProduct Name\setup.exe"**

(Assuming your CD-ROM drive is **D**. If not, substitute drive letter accordingly)

Replace with **MDP3858spu (if your product model is MDP3858SP-U)
MDP3858vu (if your product model is MDP3858V-U)
MDP3858u (if your product model is MDP3858-U)
MDP3858spue (if your product model is MDP3858SP-UE)
MDP3858vue (if your product model is MDP3858V-UE)
MDP3858ue (if your product model is MDP3858-UE)

If your drivers are found in **diskette**, type **"A:\setup.exe"**

(Assuming your floppy disk drive is **A**. If not, substitute drive letter accordingly)

Click **OK**.

4. From the **Modem Board Installation Wizard**, click **Next** and select your product model.
5. Follow any on-screen instructions to complete the software installation.
6. **Restart** your system.

This completes the installation of the modem drivers in Windows NT® 4.0. Please proceed to the next chapter to test your modem.

Chapter 5

Testing the Modem Card

This chapter contains information on how to test your modem card in Windows® 95/98 & Windows NT® 4.0.



*The testing procedures for **MDP3858U series** and **MDP3858UE series** for Windows 95® and 98 are exactly the same. The following illustrations are only based on the model **MDP3858-U**, in the Windows® 95 environment.*

5.1 Windows® 95/98

1. From the Windows taskbar, click **Start > Settings > Control Panel**.

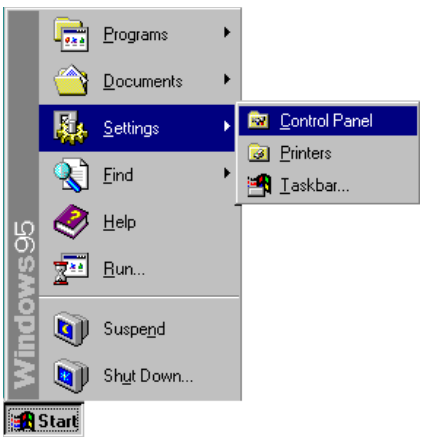

2. Double-click the **Modems** icon.



3. You will see the MDP3858 modem that you installed being listed. Click on the **Diagnostics** tab.

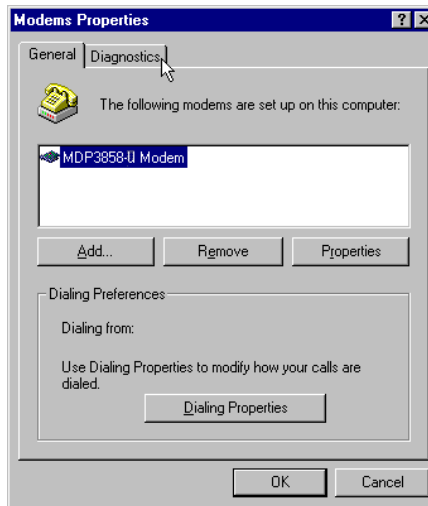

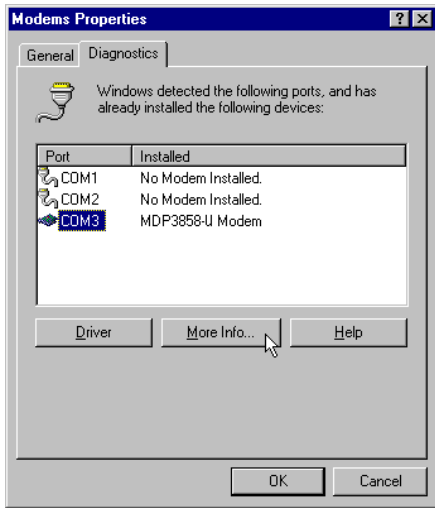

4. Select the **COM Port** that your modem is connected to and click [More Info...](#)

5. The [More Info...](#) window will appear, showing a list of AT commands. This means that your modem is now ready to run. Click **OK**.

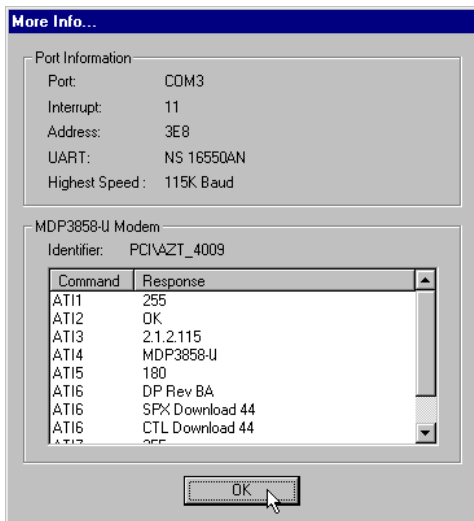

(If your modem is not installed properly, the set of AT commands will not be listed. You may also be prompted by an error message, stating that it was unable to open the COM Port. If this happens, refer to the *Appendix A - Frequently Asked Questions* “While testing the modem, the system gave an error message stating that it was unable to open the COM Port.”)

(The Port Information shown here may differ from what you see on your computer. It is determined by the COM Port which you connect your modem to)

5.2 Windows NT® 4.0

1. From the Windows taskbar, click **Start** > **Programs** > **Accessories** > **HyperTerminal** > **HyperTerminal**.
2. Key in the required information prompted by the dialog boxes.
3. Click **OK** after entering any telephone number in the dialog box.
4. At the next dialog prompt, click **Cancel**.
5. Type "**AT**" and press **Enter**. You should see a response, **OK**.
6. Your modem is now ready to run.



Frequently Asked Questions

This chapter is divided into two sections: Technical Terms and Common Problems.

Technical Terms will explain some of the technical terms used in this manual.

Common Problems will discuss on the possible solutions to some of the commonly asked questions by users. Reviewing this chapter can help you solve many problems and often eliminate the need for telephone assistance.

A.1 Technical Terms



What is TAD ?



TAD stands for Telephone Answering Device. Most modem and sound cards nowadays come with a built-in TAD connector. Reasons are as follows:

- 1. It establishes a link between the modem card and sound card internally.*
- 2. It allows user to leave the microphone connection on the sound card, while the same microphone can be used during speakerphone conversion.*
- 3. It allows user to leave the speakers connection on the sound card, while the same speakers can be used for any modem audio output. (see ReadMe.txt file for the Pin configurations)*



What is V.90 ?



V.90 is a new standard approved by the International Telecommunication Union for "56K" analog modems. It is a compromise officially reached between the two competing standards - X2 (from 3COM/USR) and K56Flex (from Rockwell/Lucent).





What is speakerphone feature ? (for MDP3858SP-U/SP-UE models)



During phone conversations, modem speakerphone feature allows you to speak over the microphone and receives from the speakers. This feature is only applicable for MDP3858SP-U/SP-UE models.

A.2 Common Problems



How do I identify the MDP3858 modem card and its drivers ?



MDP3858 has its model name printed on the serial number label located at the rear of the card.

Alternatively, you can issue an AT13 command using any Telephony Data Terminal application to get the driver version.



This modem is set to V.90. But why am I getting slow connections to my ISP ?



Majority of the telephone lines and ISP are already supporting V.90 connections. However, like all data connection, the connection is sensitive to the amount of noise present in the phone line. Hence, only very “clean” phone line can get high connection rate or throughput. You may want to check with your telephone provider.



The modem hangs up when an incoming call is received.



Disable the Call Waiting function for the Online Service, Internet Connection and/or communications software you are using.



When I tried to dial out, the system gave me an error message “No Dial Tone”.



Check the Telephone Cable connection. If necessary, plug out the Telephone Cable and reconnect the cable.



There are incomprehensible characters appearing on the screen.



The data, parity and stop bit settings are incorrect. Try using the default values or check with your ISP.



Why does my modem always connect at 33.6Kbps and not 56Kbps or V90 ?



Check with your Internet Service Provider (ISP) to ensure that they support 56Kbps or V.90 connections. You must also make sure that your modem card is using the 56Kbps driver. For modem with Country Selection feature, please ensure that the modem is set to your local country. To set the country select feature, see the following question.



I am using my system with the modem card in another country. Is there any settings that need to be changed ?



Yes. You need to ensure that the country setting for your modem card is correct for your location. Carry out the following steps:

Windows 95/98

1. From Windows environment, right-click on **My Computer** icon and click **Properties**.
2. Click **Device Manager** tab and double-click on **Modem**.
3. Select your product model and click **Properties**.
4. Click **Country Select** tab and select your current local country.



Windows NT 4.0

1. From the Windows taskbar, click **Start > Settings > Control Panel**.
2. Double-click on the **HCF Modem Country Select** icon.
3. Select your current local country.



How do I know that my modem is V.90 ready ?



Windows 95/98

1. From Windows taskbar, click **Start** > **Settings Control Panel**.
2. Double-click on **Modem** icon.
3. Click **Diagnostic** tab and select your product model.
4. Click **More Info...** option and you will see “ATI 6” displaying V.90 supported and ready.

Windows NT 4.0

1. From Windows taskbar, click **Start** > **Programs** > **Accessories** > **HyperTerminal** > **HyperTerminal**.
2. Key in the required information prompted by the dialogue boxes.
3. Click **OK** after entering any telephone number in the dialogue box.
4. At the next dialogue box prompt, click **Cancel**.
5. Type “ATI 6” and press **Enter**.
6. You will see “ATI 6” displaying **V.90** supported and ready.



How do I un-install the modem drivers installed in the system ?



Windows 95/98/NT 4.0

1. From the Windows taskbar, click **Start** > **Settings** > **Control Panel**.
2. Double-click on the **Add/Remove Programs** icon.
3. Select your product model and click **Add/Remove**. (There are 2 files related to the product, MDP3858 PCI Modem Drivers and MDP3858 PCI Modem Files. You need to remove both of them)
4. Follow the on-line instruction to complete the removal of drivers/file.



How do I see the resources listings ?



Windows 95/98

1. From the Windows taskbar, click **Start** > **Settings** > **Control Panel**.
2. Double-click the **Modems** icon.
3. Click the **Diagnostics** tab. Select your product model and click **More Info...** option.

The IRQ (Interrupt) and memory range (Address) used by the modem will be listed.

Windows NT 4.0

Run the **Windows NT Diagnostics** as follows:

1. From the Windows taskbar, click **Start**>**Programs**> **Administrative Tools (Common)**> **Windows NT Diagnostics**.
2. From the Diagnostics Window, click **Resources** tab followed by **Devices** tab.
3. Double-click **WinAcPci**.

The IRQ and memory range used by the modem will be listed.

(The COM Port and IRQ are assigned automatically by the Operating System during installation. Both the COM Port and IRQ settings cannot be changed by the user)



My system does not detect the modem when I boot up for the first time.



Windows 95/98

Make sure your modem is fully inserted into the PCI Bus slot.

However, if you are sure that the modem has been properly installed, do the following:

1. From the Windows taskbar, click **Start** > **Settings** > **Control Panel**.
2. Double-click the **System** icon.
3. Click the **Device Manager** tab.

4. Check whether there is any yellow exclamation mark (error) on the modem devices. If yes, select the device, click **Remove** and **OK**. Re-install the modem drivers.

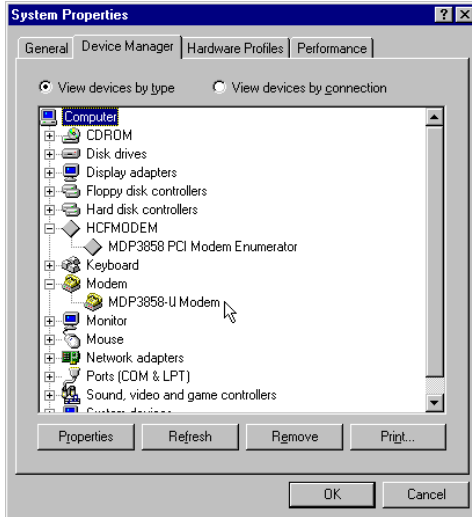

Windows NT 4.0

Not Applicable.



The Modem Board Installation Wizard says “the driver could not be installed”.



Windows 95/98

Not applicable.

Windows NT 4.0

Make sure that your modem card is fully inserted into the PCI Bus Slot and install the modem drivers again.



I have done a diagnostics test of my modem and there is nothing wrong with it. However, when I use a communications software, there seems to be an error. Why?



Windows 95/98/NT 4.0

Try to use a different telephony application like **Microsoft Fax** to fax a document. If the sending of a fax is successful, then the fax function of your modem is working fine.

Try to use **Hyperterminal** to dial up to a BBS. If the connection is successful, then the data function of your modem is working fine.

Try exiting the communications software and running it again.



While testing the modem, the system gave an error message saying that it was unable to open the COM Port.



Make sure that you have closed all communication software (e.g. Hyperterminal, Dial-up Networking, etc.) when you are doing the diagnostics test.

However, if there is no communications software running, do the following:

1. From the Windows taskbar, click **Start** > **Settings** > **Control Panel**.
2. Double-click the **System** icon.

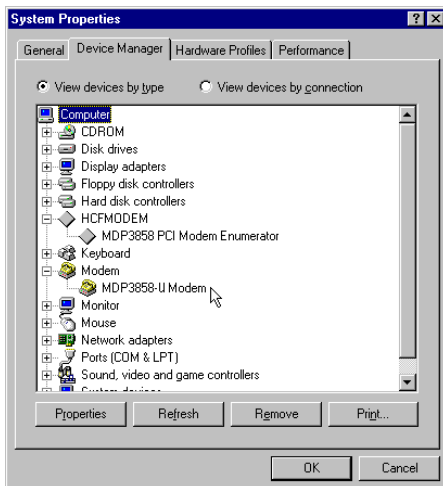

3. Click the **Device Manager** tab.
4. Check whether there is any yellow exclamation mark on the modem device. If yes, remove the modem device and re-install the modem drivers.



How do I use the modem speakerphone ? (for MDP3858SP-U/SP-UE models only)



*To use the speakerphone feature, make sure that you have installed, connected and tested your card as described in **Chapter 3, 4 and 5** respectively. Then, run the Communications Application bundled in your MDP3858 Installation CD/Disk to use the speakerphone.*



Can I make use of the MIC Jack and LINE-IN Jack on my sound card for speakerphone ? (applicable to MDP3858SP-U/SP-UE and MDP3858V-U/V-UE models only)



*You can make use of the MIC Jack and LINE-IN Jack on your compatible sound card. Use a TAD cable to internally connect your modem card to your sound card as described in **Appendix C - TAD Connection**. The TAD connection will establish a link between your modem card and sound card. In this case, you are able connect your microphone and speakers to MIC jack and LINE-OUT on your sound card to do speakerphone.*

Appendix

B

Technical Specifications

This chapter contains the technical specifications of your card. The information may be more useful for technically inclined users.

Modem Standards

- V.90, K56Flex
- V.34+, V.34, V.32bis, V.32, V.22bis, V.22, V.21
- Bell 212A, Bell 103

Modem Data Rates

- 56Kbps (download speed from Internet Service Provider)
- 33.6Kbps — 300bps

Data Throughput

- Up to 115.2Kbps (with compression) and 57.6Kbps (without compression)

Error Correction

- V.42 LAP-M and MNP2-4

Data Compression

- V.42bis and MNP5

Fax Modulations

- V.17, V.29, V.27ter, V21 Channel 2 Class 1 and Group 3 Protocol

H.324 Video Ready

- V.80, V.8bis
- Rockwell VRPI

PCI Interface

- PCI 2.1 Interface
- PCI Plug and Play
- PCI Power Management (Wake-Up on Ring through PCI PME# support*)

** only if your system supports ACPI Power Management*



The product specifications herein are subject to change without prior notifications.

Appendix C

TAD Connection

(for MDP3858SP-U/SP-UE/V-U/V-UE models)

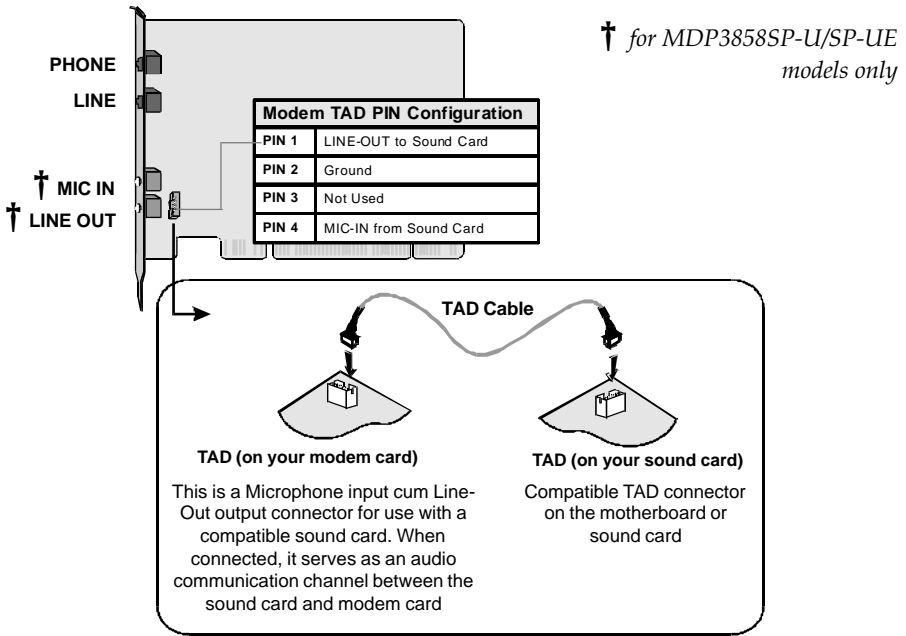

Microphone or speakers connections must be connected at the sound card if you are using TAD connection.