

# ▼▼▼▼ ANA-5910/5930/5940

PCI-to-ATM Adapter

## User's Guide



### Copyright

© 1997 Adaptec Inc. All rights reserved. The user may print one copy for personal use. Production of multiple copies, or copies for sale is strictly prohibited.

## **Trademarks**

Adaptec, the Adaptec logo, and ANA are trademarks of Adaptec, Inc. which may be registered in some jurisdictions.

Windows NT is a trademark, and Windows and Windows 95 are registered trademarks of Microsoft Corporation in the U.S. and other countries used under license.

All other trademarks are owned by their respective owners.

## **Changes**

The material in this document is for information only and is subject to change without notice. While reasonable efforts have been made in the preparation of this document to assure its accuracy, Adaptec, Inc. assumes no liability resulting from errors or omissions in this document, or from the use of the information contained herein.

Adaptec reserves the right to make changes in the product design without reservation and without notification to its users.

## **Disclaimer**

IF THIS PRODUCT DIRECTS YOU TO COPY MATERIALS, YOU MUST HAVE PERMISSION FROM THE COPYRIGHT OWNER OF THE MATERIALS TO AVOID VIOLATING THE LAW WHICH COULD RESULT IN DAMAGES OR OTHER REMEDIES.

## **Adaptec Technical Support and Services**

If you have questions about installing or using your Adaptec product, check this document first—you will find answers to most of your questions here. If you need further assistance, please contact us. We offer the following support and information services:

### ***Electronic Support***

Technical information, including product literature, answers to commonly asked questions, information on software upgrades and other topics is available electronically through the following:

- Adaptec World Wide Web (WWW) site at <http://www.adaptec.com>.
- File Transfer Protocol (FTP) server at <ftp.adaptec.com>.
- Adaptec USA Bulletin Board Service (BBS) at 408-945-7727; supports up to 28,800 bps (bits per second), 8 data bits, 1 stop bit, no parity. No product literature is available on the Adaptec BBS.
- Interactive Fax System at 408-957-7150; available 24 hours a day, 7 days a week.

### ***Technical and Product Support***

- For technical support and information about many of Adaptec's electronic support services, call 800-959-7274 or 408-945-2550, 24 hours a day, 7 days a week.
- To use the Adaptec Interactive Support System, call 800-959-7274 or 408-945-2550, 24 hours a day, 7 days a week. The system prompts you with questions regarding your problem and then provides step-by-step troubleshooting instructions.

- To speak with a product support representative, call 408-934-7274, M–F, 6:00 A.M. to 5:00 P.M., Pacific Time. After hours, on weekends, and on holidays, product support is also available for a fee at 800-416-8066.

### **Sales and Ordering Information**

- For sales information, call 800-959-7274 or 408-945-2550, M–F, 6:00 A.M. to 5:00 P.M., Pacific Time.
- To order Adaptec software and SCSI cables, call 800-442-7274 or 408-957-7274, M–F, 6:00 A.M. to 5:00 P.M., Pacific Time.
- To request additional documentation for Adaptec products, call 800-934-2766 or 510-732-3829, M–F, 6:00 A.M. to 5:00 P.M., Pacific Time.

### **Federal Communications Commission Radio Frequency Interference Statement**

WARNING: Changes or modifications to this unit not expressly approved by the party responsible for compliance could void the user's authority to operate the equipment.

This equipment has been tested and found to comply with the limits for a Class B digital device, pursuant to Part 15 of the FCC rules. These limits are designed to provide reasonable protection against harmful interference in a residential installation. This equipment generates, uses, and can radiate radio frequency energy, and if not installed and used in accordance with the instruction manual, may cause harmful interference to radio communications. However, there is no guarantee that interference will not occur in a particular installation. However, if this equipment does cause interference to radio or television equipment reception, which can be determined by turning the equipment off and on, the user is encouraged to try to correct the interference by one or more of the following measures:

- Reorient or relocate the receiving antenna.
- Increase the separation between equipment and receiver.
- Connect the equipment to an outlet on a circuit different from that to which the receiver is connected.
- Consult the dealer or an experienced radio/television technician for help.

Use a shielded and properly grounded I/O cable and power cable to ensure compliance of this unit to the specified limits of the rules.

This device complies with part 15 of the FCC rules. Operation is subject to the following two conditions: (1) this device may not cause harmful interference and (2) this device must accept any interference received, including interference that may cause undesired operation.

### **Canadian Compliance Statement**

This Class B digital apparatus meets all requirements of the Canadian Interference-Causing Equipment Regulations.

Cet appareil numérique de la classe B respecte toutes les exigences du Règlement sur le matériel brouilleur du Canada.



# ▼▼▼▼ Contents

## **1 Getting Started**

- System Requirements 1-1
  - Hardware Requirements 1-1
- Document Overview 1-3
  - How to Use This Document 1-3

## **2 Introducing ATM Networking**

- How ATM Works 2-1
  - Wide Area Connectivity 2-2
  - Scaleable bandwidth 2-3
  - Bandwidth guarantees 2-3
- Node Identification 2-3
- Virtual Channel Connections (VCCs) 2-4
- ATM SONET/SDH Support 2-4
- 25.6 Mbit/sec ATM 2-5
- Classical TCP/IP 2-5
  - Classical IP Operational Summary 2-6
  - Classical IP over ATM 2-7
- LAN Emulation 2-8
  - LAN Emulation Clients (LECs) 2-8
  - LAN Emulation Configuration Server (LECS) 2-9
  - LAN Emulation Server (LES) 2-9
  - Broadcast and Unknown Server (BUS) 2-9

## **3 Installing the Adapter**

- Connecting the ANA-5910/5930/5940 Adapter to the Network 3-4
  - Connecting to the ANA-5910 3-4
  - Connecting to the ANA-5930 3-5

Connecting to the ANA-5940 3-5

## **4 Installing ATM Version 4.0x Software for Windows NT**

Installation for Windows NT (version 4.0) 4-1

Installing LANE Device Drivers 4-2

Installing The ATM Utilities 4-7

Installation for Windows NT (version 3.51) 4-8

Installing LANE Device Drivers 4-8

Installing The ATM Utilities 4-13

Using Device Drivers and Utilities 4-14

Stopping ATM Drivers 4-14

Starting ATM Drivers 4-14

Locating Files and Directories 4-19

## **5 Installing ATM Version 2.0x Drivers for Windows NT**

Installation for Windows NT (version 4.0) 5-1

Installing CIP Client Drivers 5-2

Installing LANE Device Drivers 5-5

Installing the CIP ARP Server (Optional) 5-9

Installation for Windows NT (version 3.51) 5-13

Installing CIP Client Drivers 5-13

Installing LANE Device Drivers 5-17

Installing the CIP ARP Server (Optional) 5-21

Using Device Drivers and Utilities 5-25

Stopping ATM Drivers 5-25

Starting ATM Drivers 5-25

Locating Files and Directories 5-30

## **6 Installing ATM Software for DOS/Windows 3.1**

Configuring the Novell NetWare Client Kit for DOS/  
Windows 6-1

Installing Adaptec ATM Software for DOS/Windows 6-2

Using Frame Types with Novell NetWare 6-4

## **7 Installing ATM Software for Windows 95**

Automatically Installing Adaptec ATM Software for Windows 95 7-1

Installing Adaptec ATM Client Drivers for Windows 95 7-3

Configuring the Adapter 7-4

Removing Adaptec ATM Software for Windows 95 7-5

## **8 Installing ATM Software for Novell NetWare**

Installing Adaptec ATM Software for NetWare 3.12 8-1

Installing the ATM Software 8-1

Configuring the ATM Software 8-3

Automatically Loading the ATM Driver 8-6

Automating ATM Software Installation 8-7

Installing, Configuring, and Loading Adaptec ATM Software for NetWare 4.1 8-7

Installing and Configuring the ATM Software While Installing NetWare 4.1 8-7

Installing and Configuring the ATM Software After Installing NetWare 4.1 8-10

Automatically Loading the ATM Driver 8-14

Manually Loading the ATM Driver 8-14

Removing ATM Software 8-15

Removing ATM Software for NetWare 3.12 8-15

Removing ATM Software for NetWare 4.1 8-16

Updating ATM Software 8-17

Updating ATM Software for NetWare 3.12 8-17

Updating ATM Software for NetWare 4.1 8-17

Troubleshooting 8-18

Status Commands 8-18

Status/Error Messages 8-18

Identifying Files 8-19

Installing Patches 8-19

## **A Product Features and Specifications**

### Features A-1

ANA-5910/5930/5940 Hardware A-1

ANA-5910/5930/5940 Software A-3

Features Summary A-4

### Specifications A-5

Environment A-5

PCI Interface A-5

UTP and STP Interface (ANA-5910/5930) A-6

MMF Optical Interface (ANA-5940) A-7

## **B Windows NT Specific Error Messages and Diagnostics**

### Error Messages B-1

Diagnostics Error Messages B-3

Driver Console Error Messages B-4

Diagnostics B-11

Database File Parameters B-14

SNMP Agent B-16

## **Glossary**

## **Index**



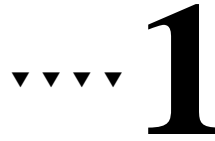

# Getting Started

This document contains information on installing and configuring the Adaptec<sup>®</sup> ANA<sup>™</sup>-5910/5930/5940 adapters. These adapters provide the interface between your computer's PCI bus and a network that uses Asynchronous Transfer Mode (ATM). Procedures in this document describe installing the adapter, installing and configuring the adapter drivers, and performing administrative and management functions for your ATM network.



---

**Note:** The procedures in this document assume that you are connecting the adapter to an external ATM local area network (LAN) switch.

---

## System Requirements

Certain hardware and software components are required to use the ANA-5910/5930/5940 adapters.

### Hardware Requirements

The minimum hardware system requirements are as follows:

- PCI rev. 2.0-compliant computer with +5V PCI slots for the ANA-5910 and +5V/+12V PCI slots for the ANA-5930/5940
- An available PCI bus master slot

- Connecting cable (see Appendix A, *Product Features and Specifications*, for additional cable specifications):

<b>Adapter Model</b>	<b>Cable</b>
ANA-5910	STP, UTP 3, or better
ANA-5930	UTP 5
ANA-5940	MMF

Adaptec does not claim to have included in this document every condition or situation that might require a caution or warning notice. Be sure to consult the documentation for your computer and any connected equipment when you are installing the equipment or changing its configuration.



---

**WARNING:** Always use caution when handling electrical equipment!

---

## Document Overview

### How to Use This Document

To use this document, first scan *this chapter* for an overview of this document.

Next read Chapter 2, *Introducing ATM Networking*, for a description of ATM and how the ANA-5910/5930/5940 adapters fit into an ATM network.

Then follow the instructions in Chapter 3, *Installing the Adapter*, for installing the adapter and connecting ATM UTP/STP or MMF.

After you install the hardware, install and configure the ATM software for the operating system you are running, as follows:

Chapter 4, *Installing ATM Version 4.0x Software for Windows NT*.

Chapter 5, *Installing ATM Version 2.0x Drivers for Windows NT*.

Chapter 6, *Installing ATM Software for DOS/Windows 3.1*.

Chapter 7, *Installing ATM Software for Windows 95*.

Chapter 8, *Installing ATM Software for Novell NetWare*

For specifications on environment, cables, or the PCI-bus interface, see Appendix A, *Product Features and Specifications*.

For error messages and diagnostics specific to Windows NT, refer to Appendix B, *Windows NT Specific Error Messages and Diagnostics*

If you do not understand some of the terms discussed in this document, refer to the *Glossary*.







# Introducing ATM Networking

As a technology, ATM represents a sharp departure from LAN alternatives such as traditional Ethernets that typically rely on shared transmission media. That is, with Ethernet, several nodes often contend for the right to transmit over shared cable segments that support only one transmission at a time. When a node successfully captures the media, it transmits its message at the maximum allowed speed, completely consuming the media. However, even in the best of circumstances, it is not unusual for two or more nodes to begin transmitting at the same time and interfere with each others transmission. Ethernet's design anticipates and compensates for unpredictable transmission collisions that occur.

## **How ATM Works**

In contrast to other methods, ATM isolates network nodes by forcing them to attach to ATM switches using dedicated connections. ATM switches then interconnect and cooperate with each other to form a network and provide communication connections. While an ATM node has full use of its switch attachment link, nodes share the capacity of the links connecting the switches. Unlike Ethernet networks, this sharing is largely invisible to the nodes. Because of this and other considerations, ATM provides numerous advantages and capabilities that are difficult or impossible to obtain with legacy LAN approaches. Perhaps the most important ATM benefits are its

native wide area connectivity, scalable bandwidth, and bandwidth guarantees.

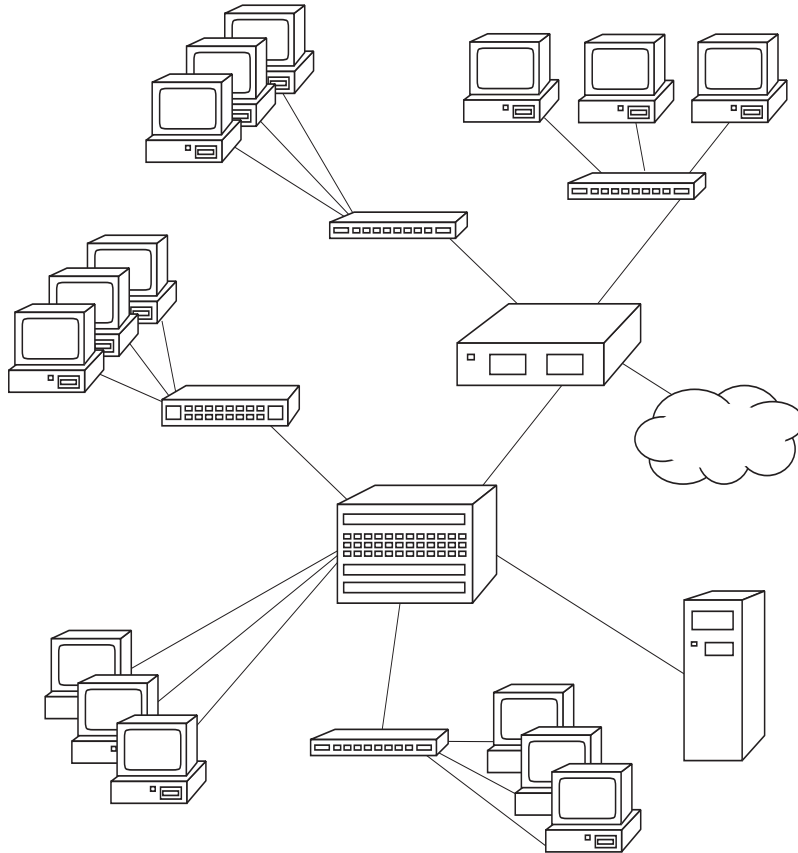

Figure 2-1. ATM Networking

### Wide Area Connectivity

International telephone companies have standardized ATM to support their domestic telephone voice traffic. As nations deploy their individual ATM networks, ATM's standard definition makes it easy to interconnect these various ATM networks into a cooperative integrated global network.

## Scaleable bandwidth

ATM defines how ATM end-stations, such as your PC or workstation, connect to ATM switches and how ATM switches interconnect with each other. Because these various connections consist of dedicated links, their construction (metal wire or fiber optic) and the transmission speed they support may vary from link to link. When connections require higher speed, it is usually easy to upgrade the connection without disrupting other network nodes and switches, upgrading transmission bandwidth only where necessary.

## Bandwidth guarantees

Whenever one ATM node communicates with another, it uses a virtual connection that disguises the fact that connections actually traverse shared media. In this way, ATM networks make it appear that connections are dedicated. Only if the necessary bandwidth is available along the entire route does the connection setup complete successfully. ATM's guaranteed bandwidth allows connections to transport audio, video, and image data that is sensitive to time delays that occur when bandwidth is unpredictable as it is with Ethernet.

To further improve transmission predictability, ATM networks transmit small, 53 byte messages, called cells. A cell contains 48 data bytes and a five-byte header. Since ATM transmission media only transport only one cell at a time, the small message size allows switches and nodes to transmit high priority cells with minimum delay. If switches are transmitting lower priority cells when a high priority cell arrives, higher priority cell transmission quickly commences when the lower priority transmission completes.

## Node Identification

ATM *end stations* (nodes such as workstations) each have a unique connection to any ATM switch to which they connect. The connection point at the switch is called a switch *port* and the switch is a *local switch* for the node. ATM nodes each have a globally-unique network address. There are various address schemes but, in most cases, nodes receive their assigned network address from the switch.

To communicate with another node, an initiating node must initiate a signaling request to the signaling *Virtual Channel Connection (VCC)* residing within the local switch.

## Virtual Channel Connections (VCCs)

*Virtual Channel Connections (VCCs)* are either constructed manually or constructed by both nodes and all intervening switches. Manually constructed connections are called *Permanent Virtual Circuits (PVCs)* and must be manually deconstructed. With *Switched Virtual Connections (SVCs)*, one node initiates the VCC setup process which proceeds switch-by-switch until the desired node is reached. ATM networks that provide SVCs are considered *signaling environments*. Finally VCCs can be point-to-point, allowing one transmitter and receiver for any cell, or multicast VCCs that allow one node to transmit a cell that many nodes receive.

An initiating node sends a connection setup request to its switch via a special *signaling VCC*. The signaling VCC is an example of a *control VCC* - a VCC that remains constantly active. The switch then cooperates with other nodes to construct a virtual connection that provides the appropriate *Quality of Service (QoS)*. Link by link, the procedure reserves the bandwidth required by the connection. If the connection setup is successful, the nodes communicate using the VCC which is represented by a *Virtual Channel Identifier (VCI)* and a *Virtual Path Identifier (VPI)*. Together, the VCI and VPI identify the VCC for its duration, and communicating nodes reference the VPI/VCI pair within each transmitted cell, permitting subsequent cell switching activity. When the communication process is complete, one of the communicating nodes initiates the SVC tear-down.

## ATM SONET/SDH Support

SONET is an acronym for Synchronous Optical Network - the contemporary technology many North American telephone companies use to bundle and transport domestic voice data within Synchronous Transport Signal (STS) data frames SDH is an acronym for Synchronous Digital Hierarchy - the contemporary technology many European telephone companies use to bundle and transport domestic voice data Synchronous Transport Module (STM) data frames. Through international standardization efforts, SONET and SDH are essentially identical except that the smallest STM frame (STM-1) is three times larger than the smallest STS frame (STS-1).



ATM uses SONET and SHD technology to reduce costs while achieving high transmission rates. Essentially, ATM combines multiple STS-1 frames into STS superframes (STS-Nc, where N stands for some integer value) and likewise for STM-1 frames. Transmitting 8,000 single STS-1 frames at telephone company in a second, referred to as STS-1 transmission, produces a 51.84 Mbit/sec transmission rate.

An STS-3C transmission transmits 8,000 STS-3c superframes in a second, each composed of three concatenated (combined) STS-1 frames. This produces a 155.52 Mbit/sec transmission rate which is conventionally rounded to 155 Mbits/sec. The STS-3c transmission rate is identical to the STM-1 transmission rate. ATM supports, or will eventually support the following:

- STS-1: 51.84 Mbits/sec
- STS-3c: 155.52 Mbits/sec
- STS-12c: 622.08 Mbits/sec
- STS-24c: 1244.16 Mbits/sec
- STS-48c: 2488.32 Mbits/sec
- STS-192c: 9953.28 Mbits/sec

Adaptec ATM products currently support the STS-3C/STM-1 transmission rate of 155.51 Mbits/sec.

## **25.6 Mbit/sec ATM**

ATM also supports 25.6 Mbit transmission speeds. Adaptec products providing this transmission speed attach to switches which can subsequently transport the data at any ATM transmission speed necessary to reach another switch or node.

## **Classical TCP/IP**

A data communication protocol is a set of conventions that communicating entities observe to achieve unambiguous data exchange and the TCP/IP suite of protocols is the most commonly used data communication protocol suite. TCP/IP has prevailed because it is an extensible, effective data communication protocol suite designed from the ground up to integrate disparate networks with heterogeneous computers. Because of its interconnectivity origins, TCP/IP is essential to the Internet, which itself consists of

numerous interconnected networks. This section introduces the TCP/IP protocol suite which ATM necessarily supports untouched.

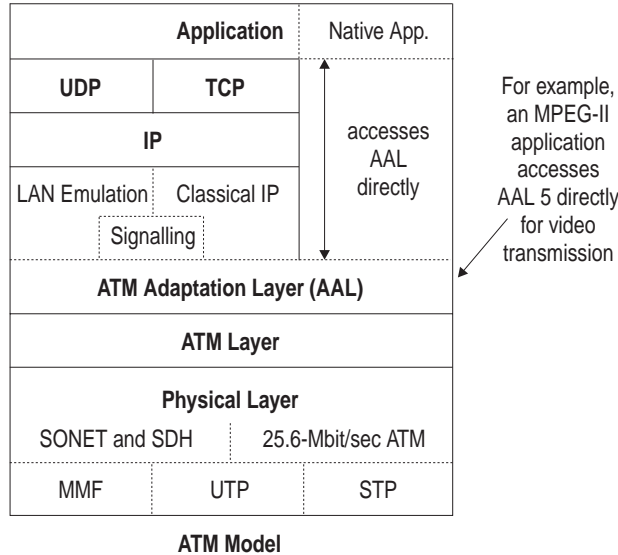

### Classical IP Operational Summary

Within workstations, a TCP/IP communication protocol stack receives application data streams and fragments the flows into datagrams. These datagrams can be up to 64 Kbytes long, though they are usually much smaller to accommodate physical media constraints. Within the stack, IP components prepend datagram headers and deliver the datagram to MAC components, such as Ethernet components, for transmission. Intermediate routers route the IP datagrams to destinations, further fragmenting the datagrams into smaller datagrams if necessary. When datagrams arrive, perhaps out of order, receiving host IP components reassemble the datagrams and corresponding TCP components reconstruct the original data stream before delivering the data to an application. IP provides a connectionless, datagram transmission and routing conduit while TCP superimposes necessary guaranteed data delivery considerations between applications using mechanisms such as exponential back off and slow start up transmission rate flow controls as well as message receipt acknowledgments.

Within popular implementations, IP receives and delivers data from and to two widely available higher level layers, TCP and UDP. UDP

stands for *User Datagram Protocol*. Both TCP and UDP have associated processes and applications that produce the messages and streams TCP and UDP receive and deliver. While TCP provides a reliable data transport mechanism to host applications including checksums, UDP provides applications-specific IP addresses but only provides its applications access only to IP's connectionless, unreliable delivery.

## **Classical IP over ATM**

Within contemporary networks, host IP software and IP routers get datagrams from network sources to network destinations. Within an ATM network, the ATM *adaptation layer* intercepts and converts IP datagrams to and from cells. This spans the message transmission differences inherent within each communication design. However, it does not address the behavioral differences between components above this layer. For instance, unlike ATM, the legacy delivery process does not itself guarantee reliable, in-order delivery.

Because TCP/IP applications were designed in LAN environments that naturally provided broadcast services that are unavailable with native ATM, other differences also require consideration before ATM can seamlessly transport IP datagrams. These mechanisms resolve IP addresses to ATM network addresses and provide TCP/IP's *Address Resolution Protocol (ARP)* support. Many of these considerations are resolved in the Internet Engineering Task Force (IETF) Request For Comment 1577 (RFC 1577). This document provides protocols, collectively referred to as *Classical IP over ATM*, that introduce the concept of a *Logical IP Subnet (LIS)* - a group of ATM nodes, *LIS clients*, that belong to the same IP subnet.

Within each LIS, a single ATM ARP (ATMARP) resolves ATM addresses for the LIS clients. As nodes become operational, they contact their ATMARP server and provide ATM and IP address information to the ATMARP server. The server maintains a table containing this information and references it whenever a LIS client requests IP ARP address resolution. When a LIS client obtains the ATM address of another client, it can establish direct communication with the other LIS client using a conventional ATM connection. To ensure table accuracy and station mobility, the ATMARP server periodically discards old entries.

## LAN Emulation

Clearly, ATM's *connection-oriented* approach for communication is distinctly different from the *broadcast-oriented* approach traditional LANs use. ATM LAN Emulation, an industry-standard facility all Adaptec ATM adapters support, provides necessary mechanisms to address this requirement.

LAN emulation allows ATM networks to provide all services available within legacy LAN environments. With LAN emulation, ATM networks use their facilities to mimic communication establishment procedures occurring within broadcast-oriented legacy LANs. Once communication is established, ATM uses normal ATM connections to exchange messages, usually many times faster than with legacy LANs. Emulated LANs may consist entirely of ATM end stations, include *transparent bridges* that connect existing LANs to ATM networks, or both.

ATM LAN Emulation facilities consist of

- LAN Emulation Clients (LECs)
- LAN Emulation Configuration Server (LECS)
- LAN Emulation Server (LES)
- Broadcast and Unknown Server (BUS)

The following sections describe these components.

### LAN Emulation Clients (LECs)

A LEC is an internal control VCC within end stations. LECs communicate with other LAN emulation components and LECs to establish and provide LAN Emulation services. A LEC wholly comprises the interface between legacy applications and ATM networks. Therefore it must support various interfaces such as NDIS and ODI.

When communicating with another LEC, *Data Direct VCCs* transport the data. For outbound data frames, LECs convert the LAN MAC addresses that legacy LAN applications use into ATM network addresses and pass the typically large application data frames to the correct ATM layer (AAL5) for conversion into cells for transmission. For inbound cells, LECs reverse the process.

### LAN Emulation Configuration Server (LECS)

A LECS usually resides within an ATM switch. When queried by a LEC over a *Control Direct VCC*, a LECS indicates what LAN(s) a LEC can participate in based on input from a network administrator. LECs use the LECS to obtain the network address of the LES. A temporary VCC, that transports this information, is the *Configuration Direct VCC*.

### LAN Emulation Server (LES)

The LES maintains a table of all ATM nodes participating within a LAN and can return appropriate values to querying nodes. The LES usually resides within a node's local switch and helps determine node addresses.

To determine appropriate ATM addresses, a LEC maintains a table of recently determined conversion values. When a value is not within the table, a LEC contacts the LES using *the LAN Emulation Address Resolution Protocol (LEARP)*.

If a target node is an ATM end-station, the LES returns its address and the process is complete. Otherwise the node is connected to a legacy LAN which attaches to the ATM network using a *transparent bridge*. If the LES does not have the appropriate MAC conversion information to resolve addresses, the LES transmits associated LEARP messages to the LES in any known transparent bridge using *Control Distribute VCCs*. If a transparent bridge LEC recognizes the specified MAC address, it provides the address to the original requesting LEC and provides necessary message-passing facilities.

### Broadcast and Unknown Server (BUS)

Occasionally, applications send LECs messages intended to be broadcast to all LAN members. In this instance, the LEC passes the message to the BUS using a *multicast VCC*. The BUS then transmits the message to each participating LAN node using a multicast using ATM multicast facilities. Receiving LECs filter these messages using the node address and pass surviving messages to intended recipients.





# ... 3

## Installing the Adapter

This chapter explains how to install the ANA-5910/5930/5940 adapter and how to connect ATM cables.

To install the adapter in a computer:

- 1 Turn OFF the computer and any attached devices, and disconnect all power cords.
- 2 Detach all cables from the back of the computer.
- 3 Remove the cover from the computer case. Refer to your computer user documentation for instructions.



---

**Caution:** To avoid possible damage to the adapter or any computer components, touch the metal part of the computer's power supply to discharge any static electricity from your clothes and body. (Use a wrist grounding strap if you have one.)

---

- 4 Locate an available PCI slot, and remove the slot cover, as shown in Figure 3-1. (Refer to the computer user documentation for more information.)

The PCI slot must support bus mastering and conform to PCI Rev. 2.0 or higher specifications. If the slot does not meet PCI Rev 2.0 specifications, dedicate an IRQ channel to the slot and specify level triggering for the slot.

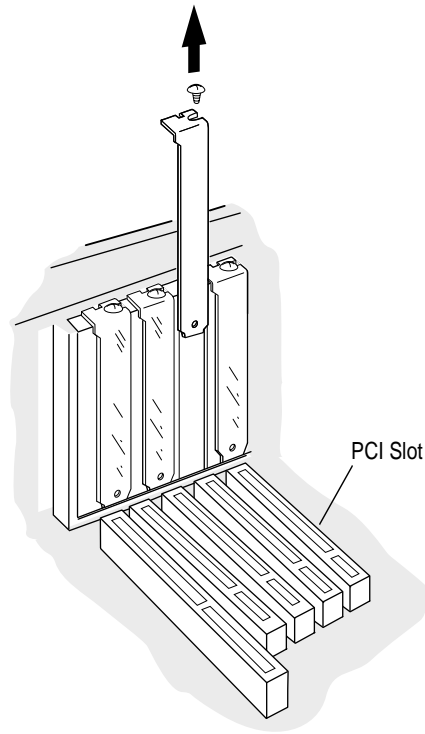

Figure 3-1. Removing the Expansion Slot Cover from the Back of the Computer

- 5** Carefully remove the card from its antistatic packaging. Hold the adapter by its edges to avoid touching the components or the connectors.



*Installing the Adapter*

- 6** Align the adapter with the PCI expansion slot, and insert the adapter firmly into the socket, as shown in Figure 3-2.

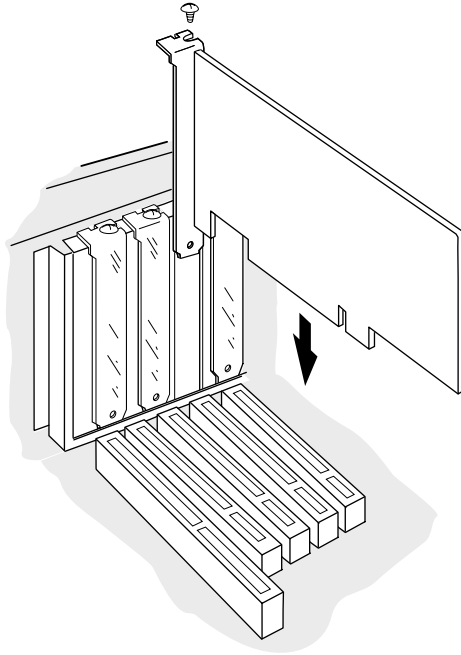

Figure 3-2. Inserting the Adapter into the Socket

- 7** Attach the adapter bracket to the computer chassis. If needed, use the screw you removed in step 4 on page 3-1.
- 8** Reassemble the computer and replace the cover on the computer case. Refer to the computer user documentation for instructions.

## Connecting the ANA-5910/5930/5940 Adapter to the Network

Before you can use your ANA-5910/5930/5940 adapter, you must connect it to an ATM switch.

### Connecting to the ANA-5910



---

**Note:** The RJ-45 connector pinout on the adapter conforms with the IBM de facto standard. If your switch connector pinout is not compatible with this standard, obtain or create a cable to convert to the required pinout.

---

To connect the ANA-5910 to an ATM switch:

- 1 Obtain the connecting cable.
- 2 Connect the RJ-45 connector at one end of the cable to the RJ-45 socket on the ANA-5910.
- 3 Connect the RJ-45 connector at the other end of the cable to the ATM wall port or directly to the RJ-45 socket on the ATM switch, as illustrated in Figure 3-3. See your system administrator for assistance.

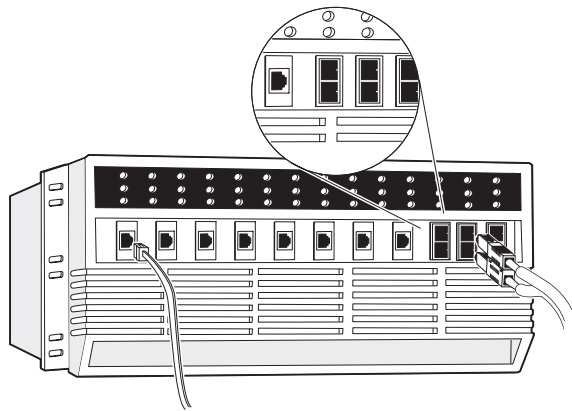

Figure 3-3. Connecting the UTP/STP Cable to the ATM Switch

## Connecting to the ANA-5930

To connect the ANA-5930 to an ATM switch

- 1 Obtain the connecting cable.
- 2 Connect the RJ-45 connector at one end of the cable to the RJ-45 socket on the ANA-5930.



---

**Caution:** Connect *only* a UTP 5 cable to the ANA-5930.

---

- 3 Connect the RJ-45 connector at the other end of the cable to the ATM wall port or directly to the RJ-45 socket on the ATM switch, as illustrated in Figure 3-3. See your system administrator for assistance.

## Connecting to the ANA-5940

To connect the ANA-5940 to an ATM switch

- 1 Obtain an MMF cable with an SC connector on one end and a connector that matches your ATM switch on the other end.
- 2 Remove the soft rubber cover on the back bracket of the ANA-5940.



---

**Caution:** Always cover open MMF cable connectors, as dust might impair transmissions.

---

- 3 Remove the rubber terminators from the ends of the MMF cable.
- 4 Attach the SC connector on the MMF cable to the MMF connector on the back bracket of the ANA-5940, as shown in

Figure 3-4. The connector is keyed and can be attached in one way only.

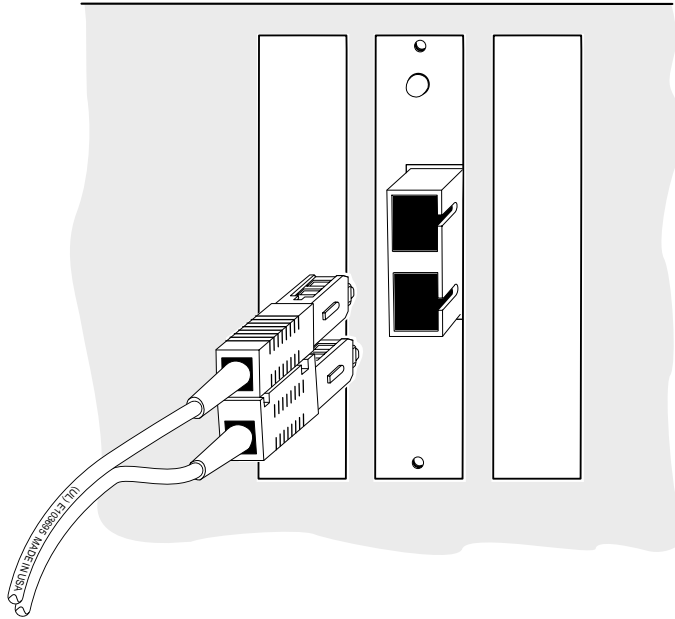

Figure 3-4. Attaching the SC Connector of the MMF Cable to the ANA-5940

- 5 Attach the other end of the MMF cable to the ATM wall port or directly to an MMF connector on the ATM switch (Figure 3-5).

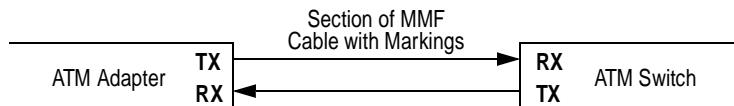

Figure 3-5. Connecting the MMF Cable to the ATM Switch



# 4

## Installing ATM Version 4.0x Software for Windows NT

This chapter explains how to install, use, reconfigure, and remove Adaptec ATM software (versions 4.0x) for Windows NT workstations and servers (with versions 4.0 or 3.51).

### Installation for Windows NT (version 4.0)

The procedures below describe installation of LAN Emulation (LANE) client device drivers and ATM Utilities for a server using Windows NT 4.0



**Note:** For information on how to install these drivers to Windows NT 3.51, refer to the *Installation for Windows NT (version 3.51)* section later in this chapter.

---

To ensure correct device configuration, install these options in the following order:

- LANE drivers
- ATM Utilities

## Installing LANE Device Drivers

LANE client drivers are installed from the Network Settings dialog box in the Control Panel. Up to 4 clients (numbered 0 to 3) can be installed at one time. To configure multiple clients, you must install the first client (0) before you can install any additional client.

### Installing a LANE Client Driver

Follow these procedures for installing a LANE client driver. If you are installing the Adaptec LANE Client device driver for the first time, your configuration address number (ELAN number) must be assigned to (0). Additional drivers can be installed with unique numbers 1 to 3.

- 1 From the Control Panel window, double-click on the **Network** icon.
- 2 Select the **Adapters** tab from the Network Settings dialog box.
- 3 Click on the **Add** button to add a device driver.
- 4 Insert the *ALANE Drivers for Windows NT* diskette in the diskette drive. Select the **Have Disk** button.
- 5 Type the drive letter of the diskette drive that contains the *ALANE Drivers for Windows NT* diskette, and select **OK**.
- 6 Select **Adaptec Inc. ATM LANE Adapter**, and select **OK**.

The Adaptec LANE Configuration dialog box appears.

The screenshot shows the 'Adaptec LANE Configuration' dialog box. It features the following fields and controls:

- ELAN Number :** A text input field containing the value '1'.
- Driver Version :** A text input field containing the value '4.1A'.
- Server Type :** A dropdown menu currently set to 'lecs'.
- MTU Size :** A dropdown menu currently set to '1516'.
- Server ATM Address :** A text input field containing the hexadecimal address '47.00.79.00.00.00.00.00.00.00.00.00.00.00.a0.3e.00.00.01.00'.
- LAN Type :** A dropdown menu currently set to '802.3'.
- Peak Cell Rate :** A dropdown menu currently set to 'LineRate'.
- ELAN Name :** An empty text input field.
- Buttons:** 'NIC Config', 'Defaults', 'Help', 'OK', and 'Cancel' are located on the right and bottom of the dialog.

*Installing ATM Version 4.0x Software for Windows NT*

Set the editable parameters in the table below (as required), and select **OK** when complete.

<b>Parameter</b>	<b>Setting</b>
ELAN Number	This read-only field contains the number automatically assigned to the LAN during installation. The ANA-5910/5930/5940 supports up to four emulated LANs, numbered 0–3.
Driver Version	Displays the current version of the Adaptec LANE driver.
Server Type	Select <b>lecs</b> if the server is a Configuration Server; select <b>les</b> if the server is a LAN Emulation Server.
MTU Size	Stands for maximum transfer unit. Select <b>9234</b> or <b>1516</b> . Note that 9234 works only if the LES and BUS for this ELAN also support this selection.
Server ATM Address	Enter the ATM address of the LECS or of the LES; 20 digit (hex) address, separated by dots (.). The default setting is WELL-KNOWN LECS ADDRESS.
LAN Type	Select <b>802.3</b> if the Ethernet LAN emulation is to be enabled in the LANE driver; select <b>802.5</b> if Token-ring LAN emulation is to be enabled.
Peak Cell Rate	The default is the Line Rate of the NIC. The PCR can be stepped down from the Line Rate. This value is specified in Mbits/second.
ELAN Name	This field is optional. Specify a character string if the switch supports this feature. No [space] characters are allowed in the string.

To change the NIC configuration, select the **NIC Config** button.

Enter the following parameters and click **OK**.

The screenshot shows a dialog box titled "Adaptec NIC Configuration". It contains three dropdown menus: "NIC Number" (set to 0), "UNI Signalling Version" (set to 3.0), and "Is this a 155 Mbs NIC Serving 25 Mbs Clients" (set to No). There are four buttons: "Defaults", "Help", "OK", and "Cancel".

---

NIC Number	Network Interface Card number. The only available number is (0) at this time.
UNI Signalling Version	Select <b>3.0</b> from the drop-down list if the switch software supports UNI 3.0 signaling; select <b>3.1</b> if the switch supports UNI 3.1 signaling.
Is this a 155 Mbs NIC Serving 25 Mbs Clients	Select Yes if you have a 155 Mbs NIC serving 25 Mbs clients. Select No (default) if you are not at 155 Mbs serving 25 Mbs clients.

---

The Network Settings dialog box displays the installed Adaptec LANE adapter in the Installed Adapter Cards list box.

- 7 Select **OK** to exit the Network Settings dialog box.



- 8 Enter Bus Type and Number from the dialog box and select **OK**.

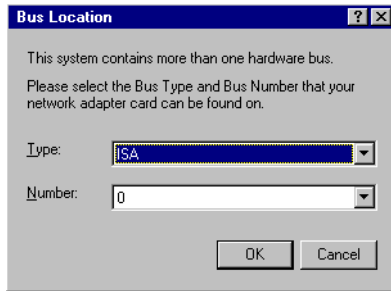

---

Type	Set the Type to <b>PCI</b> when using the Adaptec card. Default is ISA.
Number	Select the bus number slot that the card is plugged into. The total number available depends on how your hardware is configured.

---

- 9 Select **Close** from the Network Control Panel window.
- 10 If IPX/SPX is installed on your workstation, the NWLink IPX/SPX Protocol Configuration dialog box appears. If IPX/SPX is not installed, this dialog will not appear.
- Select the adapter that will support the IPX/SPX protocol from the Adapter drop-down list.
  - Select **Auto Detected** from the Frame Type drop-down list.
  - Select **OK**.
- 11 If TCP/IP is installed on your workstation, the TCP/IP Configuration dialog box appears, requiring that you set other protocol addresses and information. Refer to your Windows NT user documentation for information about setting up your TCP/IP configuration, and when you have entered the necessary TCP/IP data, select **OK**. If you do not have TCP/IP installed, these configuration screens will not appear.
- 12 Add additional clients (1 to 3) by following the above procedures, or select **Yes** to save and initialize changes.

### **Reconfiguring a LANE Client**

To reconfigure a LANE client:

- 1** From the Control Panel window, double-click on the **Network** icon.
- 2** From the Network Settings dialog box, select the **Adapters** tab.
- 3** Select the LANE adapter you want to reconfigure, for example, **Adaptec LANE Adapter (ELAN 0)**, and then select **Properties**.
- 4** Change any editable parameter as described in the installation procedures previously in this chapter.

### **Removing a LANE Client**

To remove the LANE client:

- 1** From the Control Panel window, double-click on the **Network** icon.
- 2** From the Network Settings dialog box, select the **Adapters** tab.
- 3** Select the LANE adapter you want to remove, such as **Adaptec LANE Adapter (ELAN 0)**, from the Installed Adapter Cards drop-down list, and then select **Remove**.
- 4** Select **Yes**.
- 5** In the Network Settings dialog box, select **Close**.
- 6** Select **Yes**.
- 7** If you want to reinstall the adapter you just removed, you must restart Windows NT and follow the procedures for installing additional clients.

## **Installing The ATM Utilities**

To install the Adaptec ATM Utilities

- 1** Select **Start, Settings**, then **Control Panel**.
- 2** From the Control Panel window, click on the **Network** icon.
- 3** Select the **Protocols** tab from the Network Settings dialog box.
- 4** Click the **Add** button to add a device driver.
- 5** Insert the *ALANE Utilities for Windows NT* diskette in the diskette drive and select **Have Disk**.
- 6** Type the drive letter of the diskette, and select **OK**.
- 7** Select **Adaptec ATM Utilities**, and select **OK**. The following message appears in the Setup Message dialog box:  

Install the NT SNMP service and use configure option to configure Adaptec ATM SNMP

Select **OK**. The installation stops, and the Network Settings dialog box appears.
- 8** Select **Close**.

## Installation for Windows NT (version 3.51)

This section describes installation of Lan Emulation (LANE) client device drivers for a Windows NT ATM server using version 3.51.

### Installing LANE Device Drivers

LANE client drivers are installed from the Network Settings dialog box in the Control Panel. Up to 4 drivers (numbered 0 to 3) can be installed at one time. To install multiple drivers, you must install driver 1 (0) before any additional drivers.

#### Installing a First or Single LANE Client Driver

To install the LANE driver for the first emulated LAN

- 1 In the Control Panel window click on the **Network** icon.
- 2 From the Network Settings dialog box, select **Add Adapter**.
- 3 Select **<Other> Requires disk from manufacturer** from the bottom of the Network Adapter Card drop-down list, and then select **Continue**.
- 4 Insert the *ALANE Drivers for Windows NT* diskette in the diskette drive.
- 5 Type the drive letter of the diskette drive that contains the *ALANE Drivers for Windows NT* diskette, and then select **OK**.
- 6 Select **Adaptec Inc. ATM LANE Adapter**, and then select **OK**.

The Adaptec LANE Configuration dialog box appears.

Adaptec LANE Configuration

ELAN Number : 1 Driver Version : 4.1A

Server Type : lecs MTU Size : 1516

Server ATM Address : 47.00.79.00.00.00.00.00.00.00.00.00.00.00.a0.3e.00.00.01.00

LAN Type : 802.3 Peak Cell Rate : LineRate

ELAN Name :

NIC Config Defaults Help

OK Cancel

*Installing ATM Version 4.0x Software for Windows NT*

Set the editable parameters as follows, and select **OK** when complete.

<b>Parameter</b>	<b>Setting</b>
ELAN Number	This read-only field contains the number automatically assigned to the LAN during installation. The ANA-5910/5930/5940 supports up to four emulated LANs, numbered 0–3.
Driver Version	Displays the current version of the Adaptec LANE driver.
Server Type	Select <b>lecs</b> if the server is a Configuration Server; select <b>les</b> if the server is a LAN Emulation Server.
MTU Size	Stands for maximum transfer unit. Select <b>9234</b> or <b>1516</b> . Note that 9234 works only if the LES and BUS for this ELAN also support this selection.
Server ATM Address	Enter the ATM address of the LECS or of the LES; 20 digit (hex) address, separated by dots (.). The default setting is WELL-KNOWN LECS ADDRESS.
LAN Type	Select <b>802.3</b> if the Ethernet LAN emulation is to be enabled in the LANE driver.
Peak Cell Rate	The default is the Line Rate of the NIC. The PDR could be stepped down from the Line Rate. This value is specified in Mbits/second.
ELAN Name	This field is optional. Specify a character string if the switch supports this feature. No [space] characters are allowed in the string.

To change the NIC configuration, select the **NIC Config** button.

Enter the following parameters and click **OK**



---

NIC Number	Network Integrated Controller number. Only available number is (0) at this time.
UNI Signalling Version	Select <b>3.0</b> from the drop-down list if the switch software supports UNI 3.0 signaling; select <b>3.1</b> if the switch supports UNI 3.1 signaling.
Is this a 155 Mbs NIC Serving 25 Mbs Clients	Select Yes if you have a 155 Mbs NIC serving 25 Mbs clients. Select No (default) if you are not at 155 Mbs serving 25 Mbs clients.

---

The Network Settings dialog box displays the installed Adaptec LANE adapter in the Installed Adapter Cards list box.

- 7 Select **OK** to exit the Network Settings dialog box.

- 8 Enter Bus Type and Number from the dialog box and select **OK**.

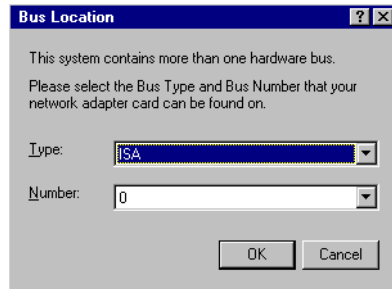

---

Type	Set the Type to <b>PCI</b> when using the Adaptec card. Default is ISA.
Number	Select the bus number slot that the card is plugged into. The total number available depends on your hardware configuration.

---

- 9 Select **OK** from the Network Control Panel window.
- 10 If IPX/SPX is installed on your workstation, the NWLink IPX/SPX Protocol Configuration dialog box appears. If IPX/SPX is not installed, this dialog box will not appear.
- Select the adapter that will support the IPX/SPX protocol from the Adapter drop-down list.
  - Select **Auto Detected** from the Frame Type drop-down list.
  - Select **OK**.
- 11 If TCP/IP is installed on your workstation, the TCP/IP Configuration dialog box appears, requiring that you set other protocol addresses and information. Refer to your Windows NT user documentation for information about setting up your TCP/IP configuration. When you have entered the necessary TCP/IP data, select **OK**. If you do not have TCP/IP installed, these configuration screens will not appear.

- 12 Add additional clients (1 to 3) by following the above procedures, or Select **Restart Now** to save and initialize changes.

### **reconfiguring a LANE Client**

To reconfigure a LANE client:

- 1 In the Program Manager's Main group window, select the **Control Panel** icon.
- 2 Select the **Network** icon.
- 3 Select the LANE adapter you want to reconfigure, for example, **Adaptec LANE Adapter (ELAN 0)**, and then select **Configure**.
- 4 Change any editable parameter as described in the installation procedures earlier in this chapter.
- 5 Select **Restart Now** to save and initialize changes.

### **Removing a LANE Client**

- 1 In the Program Manager's Main group window, select the **Control Panel** icon.
- 2 Select the **Network** icon.
- 3 Select the LANE adapter you want to remove, such as **Adaptec LANE Adapter (ELAN 0)**, from the Installed Adapter Cards drop-down list, and then select **Remove**.
- 4 Select **Yes**.
- 5 In the Network Settings dialog box, select **OK**.
- 6 Select **Restart Now** to save and initialize changes.



## **Installing The ATM Utilities**

To install the Adaptec ATM Utilities

- 1** In the Program Manager's Main group window, select the **Control Panel** icon.
- 2** Select the **Network** icon.
- 3** Select **Add Adapter** from the Network Settings dialog box.
- 4** Select **<Other> Requires disk from manufacturer** from the bottom of the Network Adapter Card drop-down list, and then select **Continue**.
- 5** Insert the *ALANE Utilities for Windows NT* diskette in the diskette drive.
- 6** Type the drive letter of the diskette drive that contains the diskette with the ATM utilities, and then select **OK**.
- 7** Select **Adaptec ATM Utilities**, and then select **OK**. The following message appears in the Setup Message dialog box:  

Install the NT SNMP service and use configure option to configure Adaptec ATM SNMP

When you select **OK**, the installation stops, and the Network Settings dialog box appears.
- 8** Select **Close**.

## Using Device Drivers and Utilities

### Stopping ATM Drivers

To stop ATM drivers:

- 1 If your path is not set up, change to the following directory:  
    \winnt\system32\adptaatm\bin
- 2 Stop the driver using the appropriate command below and in the following order:  
  
    alancnfg -s      stops the *alane.sys* driver  
    aatmcnfg -s      stops the *atmo.sys* driver

### Starting ATM Drivers

To start the ATM drivers

- 1 In the Program Manager's Main group window, select the **MS-DOS Command Prompt** icon.  
  
    The Command Prompt window appears.
- 1 If your path is not set up, change to the following directory:  
    \winnt\system32\adptaatm\bin
- 2 Start the drivers you need by entering the commands in the following order:  
  
    aatmcnfg      starts the *atmo.sys* driver; use the -q option if you *do not* want to use SVCs and if you do not want to register with an ATM switch (for example, in back-to-back connections); use the (-a) option if your switch does not support ILMI address registration  
  
    alancnfg      starts the *alane.sys* driver

Various command-line options are available for each utility. You can get help for any of the commands listed in this appendix by typing -h after the utility, for example:

```
aatmcnfg -h
```

### ***aatmcnfg.exe***

The *aatmcnfg.exe* utility is used for configuring the *atmo.sys* driver. The following is the syntax for using this utility:

```
aatmcnfg [-f ConfigFile] [-x n] [-s | d | p | q | a]
```

Options:

- s shutdown
- d debug
- p print status
- q no signalling
- a no address registration
- x n delete PVC channel n

Use the -q option only if you *do not* want to use SVCs and if you *do not* want to register with a switch, as in back-to-back connections or when running diagnostics. Use the -a option if your switch *does not* support address registration. Use the -f ConfigFile option to start the *atmo.sys* driver with a database file other than the default *base.db*, for example, *trial.db*.



**Note:** When you run the utility *aatmcnfg* without options, the driver registers with the switch. If the driver fails to register with the switch, enter *aatmcnfg -s* to stop the driver then try starting it again.

---

### **aatmdia<sub>g</sub>.exe**

The *aatmdia<sub>g</sub>.exe* utility is used to diagnose the ATM adapter. The following is the syntax for using this utility:

```
aatmdiag [-option "[command][; command]"]1
```

#### Options:

- |                   |  |
|-------------------|--|
| -c number         | specifies the controller number  |
| -d <0-1>          | indicates the log level for loop command<br>0 = Inhibit pass messages (default)<br>1 = Print pass messages |
| -f <filename>1    | specifies the input file (i.e., if you created a batch file with the tests listed in the file)             |
| -l <log Filename> | specifies the log file to use  |
| -h                | display this information   |

#### Commands:

Any command listed with the 'help' command when in 'aatmdia<sub>g</sub>'. Type 'aatmdia<sub>g</sub> help' for the list of valid commands.

Type help at the ADM:x> prompt for additional help in the *aatmdia<sub>g</sub>.exe* utility.

```
ADM:0> help
```

---

<sup>1</sup> Use the -f option and the file name if you created a batch file with the tests listed in the file.

*Installing ATM Version 4.0x Software for Windows NT*

General commands supported:

info	Displays network interface controller general information.
log_level	Set the diagnostics log level.
loop	Loop on specified list of diagnostic commands.
quit   exit	Quit ATM diagnostic program.

Specific diagnostic test commands supported:

selftest	Execute Self Test diagnostic tests.
sar_mem_e	Execute extended SAR Memory diagnostic tests.
atm_external	Execute ATM External Loopback tests (loopback cable required).

***alanecnfg.exe***

the *alanecnfg.exe* utility is used to start the *alane.sys* driver. The following is the syntax for using this utility.

-s	stop LEC
-p	LEC status
-pv	VCC status
-pa	arp status
-t	Statistics

***aatmcons.exe***

The *atmoconsole.exe* utility is used to display console error messages on an MS-DOS screen. The following is the syntax for using this utility (no online help is available for this utility):

aatmcons	starts the console on the current MS-DOS screen
start aatmcons	starts the console on the separate MS-DOS screen
Ctrl + C	stops atmoconsole and exits the separate MS-DOS screen

## Locating Files and Directories

The following table lists the files that are copied onto your hard drive when you install the LAN Emulation (LANE) client drivers. The specific files that are installed depend on which driver you installed.

The following files are copied and subdirectories created:

Default Directory Structure	File	Description
\systemroot\system32	<i>aatmsnmpd.dll</i> <i>adptcnfg.dll</i> <i>oemnadx.inf</i> <i>oemnxpn.inf</i> <i>adptalan.dll</i>	SNMP agent driver ATM configuration driver ATM OEM installation file Utilities OEM installation file LANE configuration driver
\systemroot\system32 \drivers	<i>atmo.sys</i>	ATM driver; includes CIP
	<i>natm.sys</i>	The link for the <i>atmo.sys</i> driver
	<i>alane.sys</i>	LANE driver
\winroot\system32\adpta atm\bin (These files must be in this directory.)	<i>aatmcnfg.exe</i>	ATM startup program
	<i>alancnfg.exe</i>	LANE startup program
	<i>aatmdiag.exe</i>	ATM adapter diagnostic program
	<i>aatmcons.exe</i>	Displays console error messages
	<i>aatmndd.exe</i>	Debug utility
	<i>aatmui.exe</i>	GUI interface for ATM services, start/stop services
	<i>console.ico</i> <i>diagcmd1.ico</i> <i>selftest.ico</i>	Icon files for executables.
\winroot\system32\adpta atm\config	<i>base.db</i> <i>alanex.db</i>	Your workstation's specific database files for the drivers





## Installing ATM Version 2.0x Drivers for Windows NT

This chapter explains how to install, use, reconfigure, and remove Adaptec ATM software (versions 2.0x) for Windows NT workstations and servers (with versions 4.0 or 3.51).

### Installation for Windows NT (version 4.0)

The procedures below describe installation of ATM, Classical IP (CIP), and Lan Emulation (LANE) client device drivers when setting up a Windows NT ATM server using version 4.0.



**Note:** For information on how to install these drivers to Windows NT 3.51, refer to the *Installation for Windows NT (version 3.51)* section later in this chapter.

---

To ensure correct device configuration, install these drivers in the following order:

- Classical IP (CIP) client drivers
- LANE drivers
- CIP ARP server (optional drivers, purchased separately)

## Installing CIP Client Drivers

Install these drivers before installing the LANE drivers and the CIP ARP server.

- 1 From the Control Panel window, double-click on the **Network** icon.
- 2 Select the **Adapters** tab from the Network Settings dialog box.
- 3 Insert *Device Driver for Windows NT Disk 1* in the diskette drive. Select the **Have Disk** button.
- 4 Type the drive letter of the diskette drive that contains *Device Driver for Windows NT Disk 1*, and then select **OK**.
- 5 Select **Adaptec Inc.ATM ANA-59x0 Adapter(CIP)**, and then select **OK**.

The Adaptec ATM Base Driver/CIP Configuration dialog box appears.

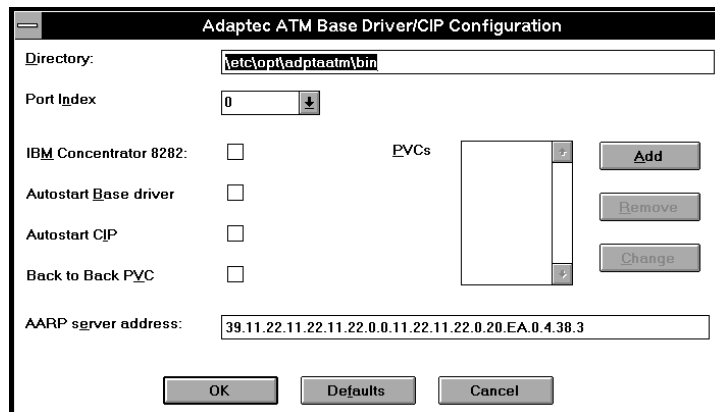

- 6 Add PVCs as follows:

Select **Add** next to the PVCs list box. The PVC Configuration dialog box appears.

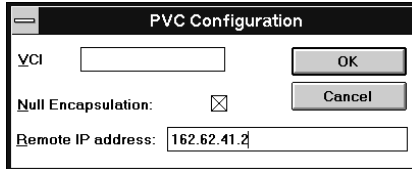

Set the parameters in the dialog box as follows, and select **OK**:

Parameter	Setting
VCI	Type a number from 32 to 1023.
Null Encapsulation	Select the check box to access another ATM adapter that uses null encapsulation or VC multiplexing. If you do not select this check box, the default transmission method, LLC/SNAP (RFC 1577), is used.
Remote IP address	If you selected the Null Encapsulation check box, the Remote IP address parameter appears. Enter the IP address of the other ATM adapter with which you want to communicate.

- 7 Change any of the editable parameters in the Adaptec ATM Base Driver/CIP Configuration dialog box, and select **OK**.

Parameter	Setting
Directory	This read-only field contains the directory where the ATM software is located.
Port Index	Leave this parameter at its 0 default setting; <i>the Port Index parameter is not implemented at this time.</i>
IBM Concentrator 8282	Select the check box if you have an ANA-5910 and are connecting to an IBM Concentrator 8282.
Autostart Base driver	Select the check box to automatically start the base driver at boot-up.

Parameter	Setting
Autostart CIP	Select the check box to automatically start the CIP client driver at boot-up.
Back to Back PVC	Select the check box to use the CIP client in back-to-back mode without involving the switch.
AARP server address	Enter the address of the CIP ARP server; 20-byte, 40 hex characters. If the ARP server address has not been established, use the default setting.
PVCs	Use the PVCs list box to add, change or remove PVCs.

- 8 Select **PCI** from the Bus Type drop-down list in the Bus Location dialog box, and select the bus number to which the ATM adapter is attached from the Bus Number drop-down list. Then select **OK**.

The installer copies the base driver to the following directory:

*drive*:\*systemroot*\System32\drivers

where

*drive* = boot drive letter

*systemroot* = SystemRoot directory

- 9 When the Setup Message dialog box appears, insert *Device Driver for Windows NT Disk 2* in the diskette drive, and select **OK**.
- 10 If NT SNMP has not been installed on your workstation, the Setup Message dialog box appears advising you to install the NT SNMP service and to configure the Adaptec ATM SNMP agent. Select **OK**.

When the Network Settings dialog box appears, the ATMO (base) Driver appears in the Installed Network Software list box, and the Adaptec ATM adapter appears in the Installed Adapter Cards list box.

- 11 Select **Close** to exit the Network Settings dialog box.

- 12 If TCP/IP is installed on your workstation, the TCP/IP Configuration dialog box appears, requiring that you set other protocol addresses and information. Refer to your Windows NT user documentation for information about setting up your TCP/IP configuration, and when you have entered the necessary TCP/IP data, select OK. If you do not have TCP/IP installed, these configuration screens will not appear.
- 13 Select **Yes** to save and initialize changes.

### Installing LANE Device Drivers



---

**Note:** Ensure that CIP drivers have been installed before LANE client drivers. If no CIP drivers have been installed, follow the procedures in the previous section to install them.

---

LANE client drivers are installed from the Network Settings dialog box in the Control Panel. Up to 4 clients (numbered 0 to 3) can be installed at one time. You must install the first client (0) before you can install any additional client.

#### Installing a LANE Client Driver

- 1 From the Control Panel window, double-click on the **Network** icon.
- 2 From the Network Settings dialog box, select the **Adapters** tab.
- 3 Click on the **Add** button to add a device driver.
- 4 Insert the *LAN Emulation Client* diskette in the diskette drive.
- 5 Select the **Have Disk** button.
- 6 Select the drive letter of the diskette drive that contains the *LAN Emulation Client* diskette, and then select **OK**.
- 7 Select **Adaptec Inc. ATM LANE Adapter**, and then select **OK**.

The Adaptec LANE Configuration dialog box appears.

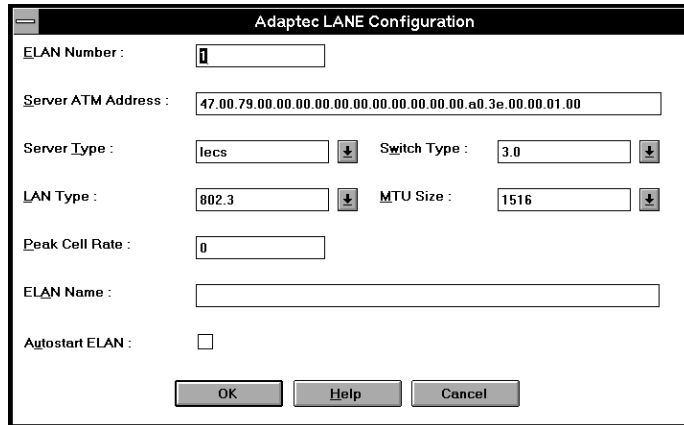

Set the editable parameters as follows, and select **OK**.

Parameter	Setting
ELAN Number	This read-only field contains the number automatically assigned to the LAN during installation. The ANA-5910/5930/5940 supports up to four emulated LANs, numbered 0–3.
Server ATM Address	Enter the ATM address of the LECS or of the LES; 20-digit (hex) address, separated by dots (.). The default setting is WELL-KNOWN LECS ADDRESS.
Server Type	Select <b>lecs</b> if the server is a Configuration Server; select <b>les</b> if the server is a LAN Emulation Server.
Switch Type	Select <b>3.0</b> from the drop-down list if the switch software supports UNI 3.0 signaling; select <b>3.1</b> if the switch supports UNI 3.1 signaling.
LAN Type	Select <b>802.3</b> from the drop-down list if Ethernet LAN emulation is to be enabled in the LANE driver; select <b>802.5</b> if Token-ring LAN emulation is to be enabled.

*Installing ATM Version 2.0x Drivers for Windows NT*

Parameter	Setting
MTU Size	Stands for maximum transfer unit. Select <b>9234</b> or <b>1516</b> from the drop-down list.
Peak Cell Rate	The peak cell rate is the rate, in Mbits/sec, at which cells are transferred. Enter a number from 0 through 353208. The <b>0</b> value defaults to the full line rate of the NIC. Use <b>58962</b> for 25 Mbits/sec; use <b>353208</b> for 155 Mbits/sec.
ELAN Name	Enter a name if the client's LECS requires ELAN name registration; 32 characters maximum; no spaces.
Autostart ELAN	Select the check box to automatically start the LANE driver at boot-up.

The Network Settings dialog box displays the installed Adaptec LANE adapter in the Installed Adapter Cards list box.

- 8** Select **OK** to exit the Network Settings dialog box.
- 9** If IPX/SPX is installed on your workstation, the NWLink IPX/SPX Protocol Configuration dialog box appears. If IPX/SPX is not installed, this dialog will not appear.
  - Select the adapter that will support the IPX/SPX protocol from the Adapter drop-down list.
  - Select **Auto Detected** from the Frame Type drop-down list.
  - Select **OK**.
- 10** If TCP/IP is installed on your workstation, the TCP/IP Configuration dialog box appears, requiring that you set other protocol addresses and information. Refer to your Windows NT user documentation for information about setting up your TCP/IP configuration, and when you have entered the necessary TCP/IP data, select **OK**. If you do not have TCP/IP installed, these configuration screens will not appear.
- 11** Add additional clients (1 to 3) by following the above procedures, or select **Yes** to save and initialize changes.

### **Reconfiguring a LANE Client**

To reconfigure a LANE client:

- 1** From the Control Panel window, double-click on the **Network** icon.
- 2** From the Network Settings dialog box, select the **Adapters** tab.
- 3** Select the LANE adapter you want to reconfigure, for example, **Adaptec LANE Adapter (ELAN 0)**, and then select **Properties**.  
The Adaptec LANE Configuration dialog box appears.
- 4** Set the editable parameters as described in the sections above.

### **Removing a LANE client**

- 1** From the Control Panel window, double-click on the **Network** icon.
- 2** From the Network Settings dialog box, select the **Adapters** tab.
- 3** Select the LANE adapter you want to remove, such as **Adaptec LANE Adapter (ELAN 0)**, from the Installed Adapter Cards drop-down list, and then select **Remove**.
- 4** Select **Yes**.
- 5** In the Network Settings dialog box, select **Close**.
- 6** Select **Yes** to save and initialize changes.



## Installing the CIP ARP Server (Optional)

If your workstation will function as the ATM CIP ARP server, you must install the CIP client software (which must be purchased separately) and the ATM CIP ARP server driver. Follow the procedures below to install the ATM CIP ARP server software.

- 1 From the Control Panel window, double-click on the **Network** icon.
- 2 From the Network Settings dialog box, select the **Protocol** tab.
- 3 Click on **Add** to add a protocol.
- 4 Select the **Have Disk** button.
- 5 Insert the *RFC 1577 CIP ARP Server* diskette in the diskette drive.
- 6 Type the drive letter of the diskette drive that contains the *RFC 1577 CIP ARP Server* diskette, and then select **OK**.
- 7 Select **Adaptec ATM ARP Server**, and then select **OK**.

The Adaptec ATM ARP Server Configuration dialog box appears.

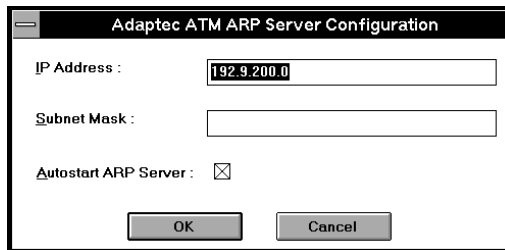

Adaptec ATM ARP Server Configuration

IP Address : 192.9.200.0

Subnet Mask :

Autostart ARP Server :

OK Cancel

Set the parameters in the dialog box as follows, and select **OK**:

Parameter	Setting
IP Address	Enter the logical IP subnet where this ATM ARP server resides; 15 characters maximum; 4 bytes, dotted decimal format; for example, 192.9.200.0
Subnet Mask	Enter the IP subnetwork mask for the ATM adapter; 15 characters maximum; 4 bytes, dotted decimal format; for example, 255.255.255.0
Autostart ARP Server	Select the check box to automatically start the ARP server driver at boot-up.

- 8 Remove the *RFC 1577 CIP ARP Server* diskette from the diskette drive.
- 9 Select **Close** to exit the Network Settings dialog box.
- 10 Select **Yes** to save and initialize changes.

#### Determining the CIP ARP Server Address



**Note:** Enter commands such as `aatmconf` should be entered from the MS-DOS command prompt, which you can access by selecting the **MS-DOS Command Prompt** icon in Program Manager's Main group window.

To obtain the 20-byte, ATM ARP server address



**Note:** The ATM driver should be started and registered to the switch.

- 1 On the ARP server, enter the following command from the directory (`letc\opt\adptaatm\bin`) where the ATM CIP software was installed:

```
aatmconf -p
```

The ATM address for the ARP server appears, for example, 39.11.22.11.22.11.22.00.00.11.22.11.22.00.00.d1.00.04.45.00

- 2 Write this address down. Then replace the 20th byte (the final byte, which is 00) with 03. Use this altered address as the ATM ARP server address when you install the CIP client software on all client workstations in the LIS.

The ATM ARP server address consists of the following:

- The first 13 bytes are from the ATM switch. (Refer to the switch documentation.)
- The next 6 bytes are the MAC address (ESI address) of the adapter installed in the ATM ARP server.

The MAC address also appears when you use the `aatmconfg -p` command.

- The 20th byte (the ATM ARP selector) must be different than the CIP client selector and the ATM selector. Adaptec ATM drivers use the following default selectors:
  - ARP selector (*arp.sys*): 03
  - CIP client selector (*acip*): 02
  - ATM selector (*aatm*): 00

### Reconfiguring the CIP ARP Server

To reconfigure the CIP ARP server:

- 1 From the Control Panel window, double-click on the **Network** icon.
- 2 From the Network Settings dialog box, select the **Services** tab.
- 3 Select **AARP Server**, and then select **Properties**.

The Adaptec ATM ARP Server Configuration dialog box appears.

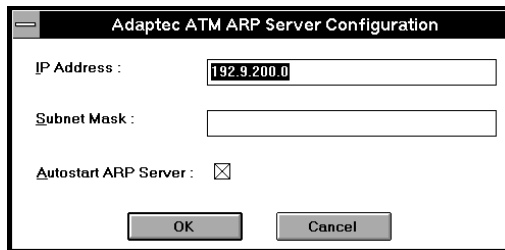

Make changes as described in the installation section.

- 4 Select **Close** to exit the Network Settings dialog box.
- 5 Select **Yes** to save and initialize changes.

#### **Removing the CIP ARP Server**

- 1 From the Control Panel window, double-click on the **Network** icon.
- 2 From the Network Settings dialog box, select the **Service** tab.
- 3 Select **AARP Server** and then select **Remove**.
- 4 Select **Yes**.
- 5 In the Network Settings dialog box, select **Close**.
- 6 Select **Yes** to save and initialize changes.

## **Installation for Windows NT (version 3.51)**

The procedures below describe installation of ATM, Classical IP (CIP), and Lan Emulation (LANE) client device drivers for a Windows NT ATM server using version 3.51. To ensure correct device configuration, install these drivers in the following order:

- Classical IP (CIP) client drivers
- LANE drivers
- CIP ARP server (optional drivers, purchased separately)

### **Installing CIP Client Drivers**

To install CIP client drivers

- 1** In the Program Manager's Main group window, select the **Control Panel** icon.
- 2** Select the **Network** icon.
- 3** Select **Add Adapter**.
- 4** Select **<Other> Requires disk from manufacturer** from the Network Adapter Card drop-down list, and then select **Continue**.
- 5** Insert *Device Driver for Windows NT Disk 1* in the diskette drive.
- 6** Type the drive letter of the diskette drive that contains *Device Driver for Windows NT Disk 1*, and then select **OK**.
- 7** Select **Adaptec Inc.ATM ANA-59x0 Adapter(CIP)**, and then select **OK**.

The Adaptec ATM Base Driver/CIP Configuration dialog box appears.

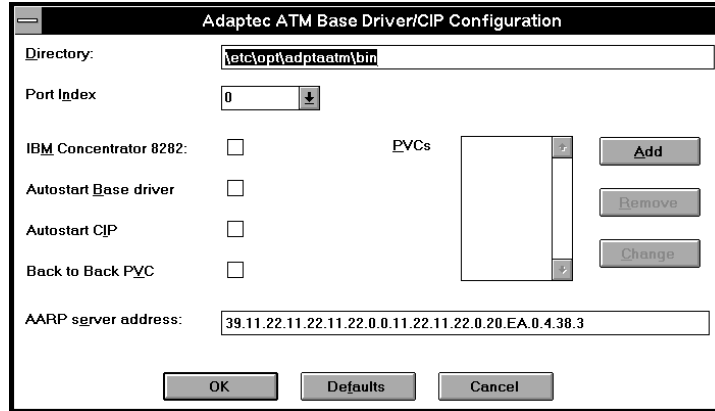

**8** Add PVCs as follows:

Select **Add** next to the PVCs list box. The PVC Configuration dialog box appears.

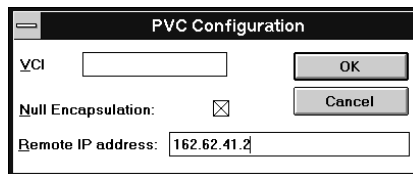

Set the parameters in the dialog box as follows, and select **OK**:

Parameter	Setting
VCI	Type a number from 32 to 1023.

*Installing ATM Version 2.0x Drivers for Windows NT*

Parameter	Setting
Null Encapsulation	Select the check box to access another ATM adapter that uses null encapsulation or VC multiplexing. If you do not select this check box, the default transmission method, LLC/SNAP (RFC 1577), is used.
Remote IP address	If you selected the Null Encapsulation check box, the Remote IP address parameter appears. Enter the IP address of the other ATM adapter with which you want to communicate.

- 9 Change any of the editable parameters in the Adaptec ATM Base Driver/CIP Configuration dialog box, and select **OK**, or, to accept the default values, simply select **OK**. To reset to default parameters, select **Defaults**.)

Parameter	Setting
Directory	This read-only field contains the directory where the ATM software is located.
Port Index	Leave this parameter at its 0 default setting; <i>the Port Index parameter is not implemented at this time.</i>
IBM Concentrator 8282	Select the check box if you have an ANA-5910 and are connecting to an IBM Concentrator 8282.
Autostart Base driver	Select the check box to automatically start the base driver at boot-up.
Autostart CIP	Select the check box to automatically start the CIP client driver at boot-up.
Back to Back PVC	Select the check box to use the CIP client in back-to-back mode without involving the switch.
AARP server address	Enter the address of the CIP ARP server; 20-byte, 40 hex characters. If the ARP server address has not been established, use the default setting.
PVCs	Use the PVCs list box to add, change or remove PVCs.

- 10 Select **PCI** from the Bus Type drop-down list in the Bus Location dialog box, and select the bus number to which the ATM adapter is attached from the Bus Number drop-down list. Then select **OK**.

The installer copies the base driver to the following directory:

`drive:\systemroot\System32\drivers`

where

`drive` = boot drive letter

`systemroot` = SystemRoot directory

- 11 When the Setup Message dialog box appears, insert *Device Driver for Windows NT Disk 2* in the diskette drive, and select **OK**.
- 12 If NT SNMP has not been installed on your workstation, the Setup Message dialog box appears advising you to install the NT SNMP service and to configure the Adaptec ATM SNMP agent. Select **OK**.  
  
When the Network Settings dialog box appears, the ATMO (base) Driver appears in the Installed Network Software list box, and the Adaptec ATM adapter appears in the Installed Adapter Cards list box.
- 13 Select **OK** to exit the Network Settings dialog box.
- 14 If TCP/IP is installed on your workstation, the TCP/IP Configuration dialog box appears, requiring that you set other protocol addresses and information. Refer to your Windows NT user documentation for information about setting up your TCP/IP configuration, and when you have entered the necessary TCP/IP data, select **OK**. If you do not have TCP/IP installed, these configuration screens will not appear.
- 15 Select **Restart Now**.



## Installing LANE Device Drivers



---

**Note:** Ensure that CIP drivers have been installed prior to LANE client drivers. If no CIP drivers have been installed, follow the procedures in the previous section to install them.

---

LANE client drivers are installed from the Network Settings dialog box in the Control Panel. Up to 4 drivers (numbered 0 to 3) can be installed at one time. You must install the first driver (0) before you can install an additional driver.

### Installing a LANE Client Driver

- 1 In the Program Manager's Main group window, select the **Control Panel** icon.
- 2 Select the **Network** icon.
- 3 Select **Add Adapter** from the Network Settings dialog box.
- 4 Select **<Other> Requires disk from manufacturer** from the bottom of the Network Adapter Card drop-down list, and then select **Continue**.
- 5 Insert the *LAN Emulation Client* diskette in the diskette drive.
- 6 Type the drive letter of the diskette drive that contains the *LAN Emulation Client* diskette, and then select **OK**.
- 7 Select **Adaptec Inc. ATM LANE Adapter**, and then select **OK**.

The Adaptec LANE Configuration dialog box appears.

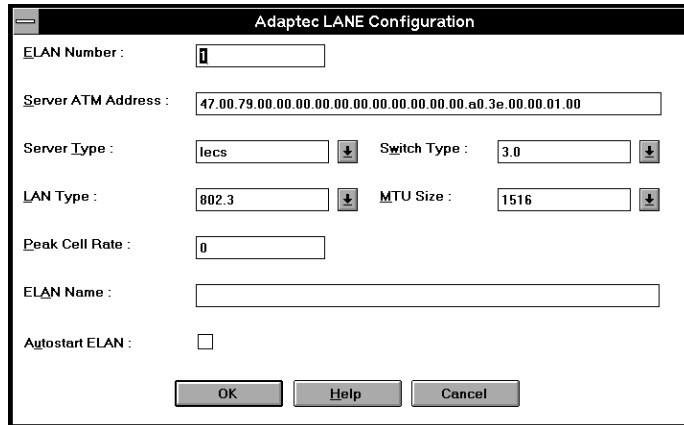

Set the following editable parameters as follows, and select **OK**:

Parameter	Setting
ELAN Number	This read-only field contains the number automatically assigned to the LAN during installation. The ANA-5910/5930/5940 supports up to four emulated LANs, numbered 0–3.
Server ATM Address	Enter the ATM address of the LECS or of the LES; 20-byte, 40 hex characters; dotted decimal format. The default setting is WELL-KNOWN LECS ADDRESS.
Server Type	Select <b>lecs</b> from the drop-down list if the server is a LAN Emulation Configuration Server; select <b>les</b> if the server is a LAN Emulation Server.
Switch Type	Select <b>3.0</b> from the drop-down list if the switch software supports UNI 3.0 signaling; select <b>3.1</b> if the switch supports UNI 3.1 signaling.

*Installing ATM Version 2.0x Drivers for Windows NT*

Parameter	Setting
LAN Type	Select <b>802.3</b> from the drop-down list if Ethernet LAN emulation is to be enabled in the LANE driver; select <b>802.5</b> if Token-ring LAN emulation is to be enabled.
MTU Size	Stands for maximum transfer unit. Select <b>9234</b> or <b>1516</b> from the drop-down list.
Peak Cell Rate	The peak cell rate is the rate, in Mbits/sec, at which cells are transferred. Enter a number from 0 through 353208. The <b>0</b> value defaults to the full line rate of the NIC. Use <b>58962</b> for 25 Mbits/sec; use <b>353208</b> for 155 Mbits/sec.
ELAN Name	Enter a name if the client's LECS requires ELAN name registration; 32 characters maximum; no spaces.
Autostart ELAN	Select the check box to automatically start the LANE driver at boot-up.

The Network Settings dialog box displays the installed Adaptec LANE adapter in the Installed Adapter Cards list box.

- 8 Select **OK** to exit the Network Settings dialog box.
- 9 If IPX/SPX is installed on your workstation, the NWLink IPX/SPX Protocol Configuration dialog box appears. If IPX/SPX is not installed, this dialog box will not appear.
  - Select the adapter that will support the IPX/SPX protocol from the Adapter drop-down list.
  - Select **Auto Detected** from the Frame Type drop-down list.
  - Select **OK**.
- 10 If TCP/IP is installed on your workstation, the TCP/IP Configuration dialog box appears, requiring that you set other protocol addresses and information. Refer to your Windows NT user documentation for information about setting up your TCP/IP configuration, and when you have entered the

necessary TCP/IP data, select OK. If you do not have TCP/IP installed, these configuration screens will not appear.

- 11 Add additional clients by following the above procedures, or select **Restart Now** to save and initialize changes.

### **reconfiguring a LANE Client**

To reconfigure a LANE client:

- 1 In the Program Manager's Main group window, select the **Control Panel** icon.
- 2 Select the **Network** icon.
- 3 Select the LANE adapter you want to reconfigure, for example, **Adaptec LANE Adapter (ELAN 0)**, and then select **Configure**.  
The Adaptec LANE Configuration dialog box appears.
- 4 Set the editable parameters as described in the above sections.
- 5 Select **Restart Now** to save and initialize changes.

### **Removing a LANE client**

- 1 In the Program Manager's Main group window, select the **Control Panel** icon.
- 2 Select the **Network** icon.
- 3 Select the LANE adapter you want to remove, such as **Adaptec LANE Adapter (ELAN 0)**, and then select **Remove**.
- 4 Select **Yes**.
- 5 In the Network Settings dialog box, select **OK**.
- 6 Select **Restart Now** to save and initialize changes.

## Installing the CIP ARP Server (Optional)

If your workstation will function as the ATM CIP ARP server, you must install the CIP client software (purchased separately) and the ATM CIP ARP server driver.

To install the ATM CIP ARP server software

- 1 In the Program Manager's Main group window, select the **Control Panel** icon.
- 2 Select the **Network** icon.
- 3 Select **Add Software** from the Network Settings dialog box.
- 4 Select **<Other> Requires disk from manufacturer** from the bottom of the Network Software drop-down list, and then select **Continue**.
- 5 Insert the *RFC 1577 CIP ARP Server* diskette in the diskette drive.
- 6 Type the drive letter of the diskette drive that contains the *RFC 1577 CIP ARP Server* diskette, and then select **OK**.
- 7 Select **Adaptec ATM ARP Server**, and then select **OK**.

The Adaptec ATM ARP Server Configuration dialog box appears.

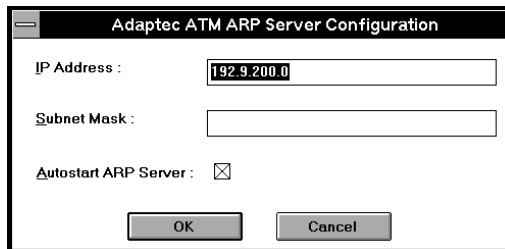

Adaptec ATM ARP Server Configuration

IP Address : 192.9.200.0

Subnet Mask :

Autostart ARP Server :

OK Cancel

Set the parameters in the dialog box as follows, and select **OK**:

Parameter	Setting
IP Address	Enter the logical IP subnet where this ATM ARP server resides; 15 characters maximum; 4 bytes, dotted decimal format; for example, 192.9.200.0
Subnet Mask	Enter the IP subnetwork mask for the ATM adapter; 15 characters maximum; 4 bytes, dotted decimal format; for example, 255.255.255.0
Autostart ARP Server	Select the check box to automatically start the ARP server driver at boot-up.

- 8** Remove the *RFC 1577 CIP ARP Server* diskette from the diskette drive.
- 9** Select **OK** to exit the Network Settings dialog box.
- 10** Select **Restart Now** to save and initialize changes.

## Determining the CIP ARP Server Address



---

**Note:** Commands such as `aatmconf` should be entered from the MS-DOS command prompt, which you can access by selecting the **MS-DOS Command Prompt** icon in Program Manager's Main group window.

---

To obtain the 20-byte, ATM ARP server address



---

**Note:** The ATM driver should be started and registered to the switch.

---

- 1 On the ARP server, enter the following command from the directory (`letc\opt\adptaatm\bin`) where the ATM CIP software was installed:

```
aatmconf -p
```

The ATM address for the ARP server appears, for example, 39.11.22.11.22.11.22.00.00.11.22.11.22.00.00.d1.00.04.45.00

- 2 Write this address down. Then replace the 20th byte (the final byte, which is 00) with 03. Use this altered address as the ATM ARP server address when you install the CIP client software on all client workstations in the LIS.

The ATM ARP server address consists of the following:

- The first 13 bytes are from the ATM switch. (Refer to the switch documentation.)
- The next 6 bytes are the MAC address (ESI address) of the adapter installed in the ATM ARP server.

The MAC address also appears when you use the `aatmconf -p` command.

- The 20th byte (the ATM ARP selector) must be different than the CIP client selector and the ATM selector. Adaptec ATM drivers use the following default selectors:

- ARP selector (`arp.sys`): 03
- CIP client selector (`acip`): 02
- ATM selector (`atm`): 00

### Reconfiguring the CIP ARP Server

To reconfigure the CIP ARP server:

- 1 In the Program Manager's Main group window, select the **Control Panel** icon.
- 2 Select the **Network** icon.
- 3 From the Installed Network Software list, select **AARP Server**, and then select **Configure**.

The Adaptec ATM ARP Server Configuration dialog box appears.

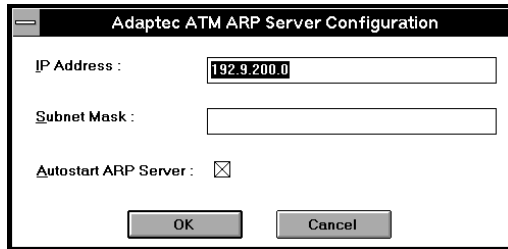

- 4 Select **OK** to exit the Network Settings dialog box.
- 5 Select **Restart Now** to save and initialize changes.



## Using Device Drivers and Utilities

### Stopping ATM Drivers

To stop ATM driver:



---

**Note:** PVCs and other configuration information not stored in the database files are lost when you stop the drivers.

---

- 1 If your path is not set up, change to the directory where you installed the software.
- 2 Stop the driver using the appropriate command below and in the following order:

<code>alanecnfg -s</code>	stops the <i>alane.sys</i> driver
<code>acipcnfg -s</code>	stops the Classical IP portion of the <i>atmo.sys</i> driver
<code>aarpcnfg -s</code>	stops the <i>aarp.sys</i> driver (only needed on the ATMARP server)
<code>aatmcnfg -s</code>	stops the <i>atmo.sys</i> driver

### Starting ATM Drivers

To start the ATM driver:

- 1 In the Program Manager's Main group window, select the **MS-DOS Command Prompt** icon.  
The Command Prompt window appears.
- 2 Change to the directory where you installed the software.

- 3 Start the drivers you need to use by entering the command and in the following order:

aatmcnfg	starts the <i>atmo.sys</i> driver; use the -q option if you <i>do not</i> want to use SVCs and if you do not want to register with an ATM switch (i.e., in back-to-back connections); use the -a option if your switch does not support ILMI address registration
aarpcnfg	starts the <i>aarp.sys</i> driver (only needed on the ATMARP server)
acipcnfg	starts the Classical IP part of <i>atmo.sys</i>
alanecnfg	starts the <i>alane.sys</i> driver.

Various command-line options are available for each utility. You can get help for any of the commands listed in this appendix by typing -h after the utility, for example:

```
aatmcnfg -h
```

### ***aarpcnfg.exe***

The *aarpcnfg.exe* utility is used for configuring the *aarp.sys* driver. The following is the syntax for using this utility:

```
aarpcnfg [-f ConfigFile] [-s | d]
```

Options:

-s	shutdown
-d	debug

Use the -f ConfigFile option to start the *aarp.sys* driver with a database file other than the default *aarp.db*.

### ***aatmcnfg.exe***

The *aatmcnfg.exe* utility is used for configuring the *atmo.sys* driver. The following is the syntax for using this utility:

```
aatmcnfg [-f ConfigFile] [-x n] [-s | d | p | q | a]
```

Options:

- s shutdown
- d debug
- p print status
- q no signalling
- a no address registration
- x n delete PVC channel n

Use the -q option only if you *do not* want to use SVCs and if you *do not* want to register with a switch, as in back-to-back connections or when running diagnostics. Use the -a option if your switch *does not* support address registration. Use the -f ConfigFile option to start the *atmo.sys* driver with a database file other than the default *base.db*, for example, *trial.db*.



**Note:** When you run the utility *aatmcnfg* without options, the driver registers with the switch. If the driver fails to register with the switch, enter *aatmcnfg -s* to stop the driver then try starting it again.

---

### ***aatmdiag.exe***

The *aatmdiag.exe* utility is used for diagnosing the ATM adapter. The following is the syntax for using this utility:

```
aatmdiag [-option "[command]"; command]"1
```

---

<sup>1</sup> Use the -f option and the file name if you created a batch file with the tests listed in the file.

Options:

-c number	specifies the controller number
-d <0-1>	indicates the log level for loop command 0 = Inhibit pass messages (default) 1 = Print pass messages
-f <filename>1	specifies the input file (i.e., if you created a batch file with the tests listed in the file)
-l <log Filename>	specifies the log file to use
-h	display this information

Commands:

Any command listed with the 'help' command when in 'aatmdiag'. Type 'aatmdiag help' for the list of valid commands.

Type help at the ADM:x> prompt for additional help while in the *aatmdiag.exe* utility.

ADM:0> help

General commands supported:

info	Displays network interface controller general information.
log_level	Set the diagnostics log level.
loop	Loop on specified list of diagnostic commands.
quit   exit	Quit ATM diagnostic program.

Specific diagnostic test commands supported:

selftest	Execute Self Test diagnostic tests.
sar_mem_e	Execute extended SAR Memory diagnostic tests.
atm_external	Execute ATM External Loopback tests (loopback cable required).

***aatmcons.exe***

The *atmoconsole.exe* utility is used to display console error messages on an MS-DOS screen. The following is the syntax for using this utility (note that there is no online help available for this utility):

atmoconsole	starts the console on the current MS-DOS screen
start	starts the console on the separate MS-DOS screen
atmoconsole	screen
Ctrl + C	stops atmoconsole and exits the separate MS-DOS screen

***acipcnfg.exe***

The *acipcnfg.exe* utility is used for configuring the Classical IP portion of the *atmo.sys* driver. The following is the syntax for using this utility:

acipcnfg [-f ConfigFile] [-s | d]

Options:

-s	shutdown
-d	debug

Use the -f ConfigFile option to start Classical IP with a database file other than the default *acip.db*.

***alanecnfg.exe***

The *alanecnfg.exe* utility is used to configure the *alane.sys* driver. The following syntax is used

-s	stop LEC
-p	LEC status
-pv	VCC status
-pa	arp status
-t	Statistics

***ndd.exe***

The *ndd.exe* utility is used for displaying Classical IP and ATMARP server information on the *atmoconsole*. Open an *atmoconsole* window (see *aatmcons.exe* on page 5-29), then execute the *ndd* command with the appropriate options at a separate MS-DOS command prompt window. The following is the syntax for using this utility:

NDD Usage: *ndd* <option <values>>

- r <other switches> for ARP server statistics
- a for arp cache entries
- v for vcc entries
- l for lis configuration details

**Locating Files and Directories**

The following table lists the files that are copied onto your hard drive when you install the Adaptec ATM Classical IP (CIP) and/or LAN Emulation (LANE) software. The specific files that are installed depend on which driver you installed.

The following files are copied and subdirectories created:

Default Directory Structure	File	Description
systemroot\system32	<i>aatmsnmpd.dll</i>	SNMP agent driver
	<i>adptaatm.dll</i>	ATM configuration driver
	<i>oemnadx.inf</i>	ATM OEM installation file
	<i>oemnxdx.inf</i>	ARP OEM installation file
	<i>adptalan.dll</i>	LANE configuration driver
	<i>aatmsrv.exe</i>	
systemroot\system32  drivers	<i>aarp.sys</i>	ARP base driver
	<i>atmo.sys</i>	ATM driver; includes CIP
	<i>alane.sys</i>	LANE driver

**Installing ATM Version 2.0x Drivers for Windows NT**

<b>Default Directory Structure</b>	<b>File</b>	<b>Description</b>
\etc\opt\adptaatm\bin (These files must be in this directory.)	<i>aarpcnfg.exe</i>	ATM ARP startup program
	<i>acipcnfg.exe</i>	Classical IP startup program
	<i>aatmcnfg.exe</i>	ATM startup program
	<i>alancnfg.exe</i>	LANE startup program
	<i>aatmdiag.exe</i>	ATM adapter diagnostic program
	<i>atmoconsole.exe</i>	Displays console error messages
	<i>aarp_1.db</i> <i>acip_1.db</i> <i>base_1.db</i>	Basic database files for the drivers
	<i>aarp.db</i> <i>acip.db</i> <i>base.db</i> <i>alanex.db</i>	Your workstation's specific database files for the drivers
	<i>ilmi.snm.mib</i>	ILMI MIB file for SunNet Manager
	<i>ndd.exe</i>	Classical IP and ATMARP information utility program





# ....6

## Installing ATM Software for DOS/Windows 3.1

This chapter describes how to install and configure Adaptec ATM software for DOS/Windows 3.1. In addition, this chapter provides information on using frame types with Novell NetWare.

### Configuring the Novell NetWare Client Kit for DOS/Windows

This section explains how to configure the Novell NetWare Client Kit for DOS/Windows to support Adaptec's ATM software.

To configure the NetWare Client Kit

- 1 Start the Novell NetWare Client installation, as explained in your Novell NetWare user documentation.
- 2 In the NetWare Client Install screen, select **OTHER DRIVERS** when prompted to "Select the driver for your network board," and then press **Enter**.
- 3 Remove the [NWClient] diskette from the floppy disk drive, insert the *ANA-59x0 DOS WIN* diskette, and press **Enter**.
- 4 From the Network Board screen, select **DOS ODI2NDI Enabler**.  
There are no configuration options for this driver.
- 5 Complete the Novell NetWare installation.
- 6 Reboot your system.

## **Installing Adaptec ATM Software for DOS/ Windows**

To install Adaptec ATM software for DOS/Window:

- 1** Insert the *ANA-59x0 DOS WIN* diskette into a floppy disk drive.
- 2** Change to the drive that contains the *ANA-59x0 DOS WIN* diskette, type the following command, and press **Enter**:  
  
    Install
- 3** At the Welcome To ATM Installation Utility! screen, press **Enter**.
- 4** To accept the default drive:\directory installation location for the Adaptec ATM software (C:\ADPT25LE), press **Enter**, or type a different drive:\directory name at the ADPT> prompt, and press **Enter**.

The installation utility creates the directory you specified above and copies the ATM files to your hard drive.

- 5** At the INSTALLATION COMPLETE! screen, press **Enter**.
- 6** At the Welcome To ATM Installation Utility! screen, press **Enter**.

- 7 At the LEC\_AUTO\_CFG screen, select one of the following:
  - To use the LECS (at the ATM Forum defined Well-Known LECS Address), press **1**.
  - To use an LES (via an address you provide), press **2**.
  - To exit the installation utility, press **3**.
- 8 If you selected options 1 or 3 in the previous step, go to step 9. If you selected option 2, type the LES ATM address at the ADPT> prompt.

A series of messages appears, advising you that the following files will be or have been modified:

*PROTOCOL.INI*  
*CONFIG.SYS*
- 9 If C:\WINDOWS is the name of your Windows directory, press **Enter** at the ADPT>C:\WINDOWS prompt. If Windows is located in a different place, type the correct drive:\directory name, and press **Enter**.

The installation utility advises you that the *system.ini* file has been modified.
- 10 If C:\NWCLIENT is the name of your NetWare Client directory, press **Enter** at the ADPT>C:\NWCLIENT prompt. If NetWare Client is located in a different place, type the correct drive:\directory name, and press **Enter**.

The installation utility advises you that the *startnet.bat* file has been modified.
- 11 At the CONFIGURATION COMPLETE! screen, press **Enter**.

## Using Frame Types with Novell NetWare

If your Novell network uses a frame type other than the default 802.2, you must edit the *PROTOCOL.INI* file (usually located in C:\ADPT25LE directory).

To support more than one frame type, you must edit the batch file in the Novell NetWare Client directory to properly find the multiple frame types.

ATM drivers are NDIS drivers that use an ODI-to-NDIS enabler to work with the Novell NetWare client. You cannot set the frame type in the *net.cfg* file in the NetWare Client directory.





# Installing ATM Software for Windows 95

This chapter describes how to install and configure Adaptec ATM software for Windows 95.

## Automatically Installing Adaptec ATM Software for Windows 95

Your computer should automatically detect and configure your Adaptec LANE adapter.

After you install the adapter in your computer, do the following:

- 1 Start Windows 95.  
The New Hardware Found dialog box appears.
- 2 Select **Driver from disk provided by hardware manufacturer**, and click **OK**.  
The Install From Disk dialog box appears.
- 3 Insert the *Adaptec LANE Driver Windows 95* diskette in Drive A, and click **OK**.  
A Copying Files... dialog box appears.
- 4 Insert your Windows 95 CD-ROM in a CD-ROM drive or your Windows 95 diskette in a diskette drive, and click **OK**.  
A Copying Files... dialog box appears.
- 5 Type the following command in the Copy files from text box

*drive:\win95*

where *drive:* is the location of the CD-ROM/diskette, and click **OK**.

A Copying Files... progress indicator appears followed by the System Settings Change help message box.

- 6** Click **Yes** to restart your computer.

## **Installing Adaptec ATM Client Drivers for Windows 95**

- 1** Click the Start button, click Settings, and then click Control Panel.
- 2** Double-click the Network icon.  
The Network dialog box appears.
- 3** Click Add.  
A Select Network Component Type dialog box appears.
- 4** Select **Adapter** from the list, and click Add.  
The Select Network adapters dialog box appears.
- 5** Click **Have Disk**.  
The Install From Disk dialog box appears.
- 6** Insert the *Adaptec ALANE Drivers for Windows 95* diskette in Drive A, and click **OK**.  
A Select Network adapters dialog box appears.
- 7** Select one of the following from the Models list, and then click **OK**:  
**Adaptec LANE Adapter - ANA 59x0 (ELAN 1)**  
**Adaptec LANE Adapter - ANA 59x0A (ELAN 1)**  
The Network dialog box appears again. Note that the Adaptec LANE adapter you selected appears in the list of installed network components.
- 8** Click **OK**.  
A Copying Files... progress indicator appears followed by the Insert Disk critical message box.
- 9** Insert your Windows 95 CD-ROM in a CD-ROM drive or your Windows 95 diskette in a diskette drive, and click **OK**.  
A *Copying Files...* dialog box appears.

- 10 Type the following command in the Copy files from text box  
`drive:\win95`  
where *drive:* is the location of the CD-ROM/diskette, and click **OK**.  
A Copying Files... progress indicator appears followed by the System Settings Change help message box.
- 11 Click **Yes** to restart your computer.

## Configuring the Adapter

To configure the Adaptec LANE adapter

- 1 Click, **Start** button, click **Settings**, and then click **Control Panel**.
- 2 Double-click the **Network** icon.  
The Network dialog box appears.
- 3 Click **Properties**.  
One of the following dialog boxes appears:  
Adaptec LANE Adapter - ANA 59x0 (ELAN 1) Properties  
Adaptec LANE Adapter - ANA 59x0A (ELAN 1) Properties
- 4 Click the **Advanced** tab, select a setting from the Property list, and specify values as follows:

Property	Value
ELAN Name	Provide a name if the client's LECS requires ELAN name registration. If the switch supports this feature, select the text box and type a character string (no spaces); otherwise, select Not Present.
ELAN Number	The list contains the number automatically assigned to the LAN during installation. The ANA-5910/5930/5940 supports up to four emulated LANs, numbered 0-3. You cannot change this value.
LAN Type	Select a value from the list. Only Ethernet (802.3) is currently supported.



Property	Value
MTU Size	Select a maximum transfer unit of 1516 or 9234 from the list. Use 9234 only if the LES/BUS supports it.
Peak Cell Rate	The peak cell rate is the rate, in Mb/sec, at which cells are transferred. Type a number from 0 to 353208 in the text box. The 0 value defaults to the full line rate of the NIC. Use 58962 for 25 Mb/sec; use 353208 for 155 Mb/sec.
Port Index	The default value is 0. <i>The Port Index setting is not implemented at this time.</i>
Server Address	Type the address of the LECS or LES in the text box; 20-byte, 40 hex characters in dotted decimal format. The default value is the ATM Forum Well-Known Address.
Server Type	Select LECS from the list if the server is a configuration server; select LES if the server is the LAN Emulation Server.
UNI Version	Select a User-Network Interface (UNI) version from the list. (The UNI version specified must be compatible with the switch or concentrator.)

## Removing Adaptec ATM Software for Windows 95

To remove Windows 95 drivers

- 1 Click the **Start** button, click **Settings**, and then click **Control Panel**.
- 2 Double-click the **Network** icon.
- 3 Select the Adaptec LANE Adapter you want to remove, click **Remove**, and click **OK**.

The System Settings Change help message box appears.

- 4 Click **Yes** to restart your computer.





# ... 8

## Installing ATM Software for Novell NetWare

The Adaptec ATM software is designed to run under Novell NetWare versions 3.12 and 4.1 and supports up to four Emulated LANs (ELANs) with the well-known/configurable LAN Emulation Configuration Server (LECS).

This chapter explains how to install, configure, load, remove, and update Adaptec ATM software for Novell NetWare.

### Installing Adaptec ATM Software for NetWare 3.12

This section contains instructions for installing and configuring Adaptec ATM software for Novell NetWare 3.12 and for loading the software automatically on system boot.



**Note:** You must install NetWare 3.12 before installing the Adaptec ATM software.

---

#### Installing the ATM Software

To install the Adaptec ATM software for Novell NetWare 3.12:

- 1 Boot the server.
- 2 Insert the *ALANE Driver for Novell NetWare v1.0* diskette in a diskette drive.

- 3 At the server system console prompt, type the following command and press **Enter**:  
    search add a:  
    The following line appears:  
    Search 2: [DOS Path ] A:
- 4 Enter the following command, and press **Enter**:  
    load nwsetup
- 5 In the Install screen, press **Esc** to install the ATM software.
- 6 From the Select Operation menu, select Default Installation and press **Enter**.
- 7 When the Install screen appears
  - a To specify a path other than the SYS:\SYSTEM directory, press **F3**
  - b To install the Adaptec ATM files in the SYS:\SYSTEM directory, press **Enter**

The system copies the files from the diskette onto the hard disk drive, and the Install screen appears advising you of the following:

  - Installation is complete.
  - You must modify your *autoexec.ncf* file. (See *Automatically Loading the ATM Driver* on page 8-6 and *Automating ATM Software Installation* on page 8-7.)
- 8 To exit the installation program, press **Esc**.

## **Configuring the ATM Software**

To configure the Adaptec ATM software for Novell NetWare 3.12

- 1** Type the following command at the system prompt, and press **Enter**:

load edit

- 2** In the File Edit screen, type the following command at the system prompt and press **Enter**:

sys:\system\atms.ncf

The File SYS:\SYSTEM\ATMS.NCF screen appears.

```
File SYS:\SYSTEM\ATMS.NCF

load alane name=alane_1_E82 frame=Ethernet_802.2
elan_id=0 lecs_nw=47007900000000000000000000000000
lecs_esi=00a03e00000100
load alane name=alane_1_EII frame=Ethernet_II
elan_id=0 lecs_nw=47007900000000000000000000000000
lecs_esi=00a03e00000100
load alane name=alane_1_E83 frame=Ethernet_802.3
elan_id=0 lecs_nw=47007900000000000000000000000000
lecs_esi=00a03e00000100
load alane name=alane_1_ESP frame=Ethernet_SNAP
elan_id=0 lecs_nw=47007900000000000000000000000000
lecs_esi=00a03e00000100
bind ipx alane_1_E82 net=105
bind ipx alane_1_EII net=106
bind ipx alane_1_E83 net=107
bind ipx alane_1_ESP net=104
;load alane name=alane_1_E82 frame=Ethernet_802.2
elan_id=1 lecs_nw=47007900000000000000000000000000
lecs_esi=00a03e00000100 elane_name=eng1
;load alane name=alane_1_EII frame=Ethernet_II
elan_id=1 lecs_nw=47007900000000000000000000000000
lecs_esi=00a03e00000100 elane_name=eng1
;load alane name=alane_1_E83 frame=Ethernet_802.3
elan_id=1 lecs_nw=47007900000000000000000000000000
lecs_esi=00a03e00000100 elan_name=eng1
;load alane name=alane_1_ESP frame=Ethernet_SNAP
elan_id=1 lecs_nw=47007900000000000000000000000000
lecs_esi=00a03e00000100 elan_name=eng1
;bind ipx alane_1_E82 net=108
;bind ipx alane_1_EII net=109
;bind ipx alane_1_E83 net=110
;bind ipx alane_1_ESP net=111
;...elan_id=2 ...
;...elan_id=3 ...
;Donot delete This line
load adptcnf.nlm
```

Four frame types for ELAN 0

Four frame types for ELAN 1

**3** Comment out load commands for any frame types you do not use.

- 4 Configure the LANE Client by changing the parameters listed in the following table, as needed. If you do not change a parameter, the default is used.

To change the parameters, for each load command, type configuration values using the following syntax:

```
parameter1=value parameter2=value ...parametern=value
```

Separate parameters with a space.

For example, the following command disables dynamic channel sharing and specifies an ELAN name of "Novell" for ELAN 0 emulating Ethernet 802.2:

```
load alane name=alane_1_E82 frame=Ethernet_802.2
elan_id=0 dcs=off elan_name=novell
```

Parameter	Default Value	Possible Values	Description
elan_id	0	0,1,2,3	Identifies the slot occupied by the ELAN. The ANA-5910/5930/5940 supports up to 4 emulated LANs, numbered 0-3.
dcs	on	on, off	Enables dynamic channel sharing (DCS), which allows ATM to transmit channels to load-balance network traffic.
qsaa1	30	30, 31	Specifies the ATM signaling adaptation layer or QSAAL version number.
q93	30	30, 31	Specifies the ATM signaling stack or Q93B version number.
les_req	no	no, yes	Specifies if the LEC has to register directly to the LES.

Parameter	Default Value	Possible Values	Description
les_nw		Network NSAP; up to 26 characters	Specifies the first 13-byte network portion of the NSAP address for the LES. This value is required if LES_REQ=yes.
les_esi		ESI NSAP; up to 14 characters	Specifies the last 7-byte end system identifier (ESI) portion of the NSAP address for the LES. This value is required if LES_REQ=yes.
lecs_nw	<sup>1</sup> Well-known LECS address	Network NSAP; up to 26 characters	Specifies the first 13-byte network portion of the NSAP address for the LECS.
lecs_esi	<sup>2</sup> Well-known LECS address	ESI NSAP; up to 14 characters	Specifies the last 7-byte ESI portion of the NSAP address for the LECS.
elan_name	default	Up to 25 characters	Specifies the ELAN name for the LES.

<sup>1</sup> 470079000000000000000000000000

<sup>2</sup> 00a03e00000100

**5** Save and exit the file.

### Automatically Loading the ATM Driver

To automatically load the Adaptec ATM driver at system boot, you must modify your autoexec.ncf file as follows:

- 1** Type the following command at the system prompt, and press **Enter**:

```
load edit
```

- 2** In the File Edit screen, type the following command at the system prompt and press **Enter**:

```
sys:\system\autoexec.ncf
```

The File SYS:\SYSTEM\AUTOEXEC.NCF screen appears.



- 3 Add the following command as the last line of the file:

sys:\system\atms.ncf

- 4 Save and exit the file.

### **Automating ATM Software Installation**

To automate Adaptec ATM software installation, you must modify your autoexec.ncf file as follows:

- 1 Type the following command at the system prompt, and press **Enter**:

load edit

- 2 In the File Edit screen, type the following command at the system prompt and press **Enter**:

sys:\system\autoexec.ncf

The File SYS:\SYSTEM\AUTOEXEC.NCF screen appears.

- 3 Add the following command line:

search add a:

- 4 Save and exit the file.

## **Installing, Configuring, and Loading Adaptec ATM Software for NetWare 4.1**

This section contains instructions for installing and configuring Adaptec ATM software for Novell NetWare 4.1 and for loading the software automatically on system boot.

### **Installing and Configuring the ATM Software While Installing NetWare 4.1**

To install the Adaptec ATM software while installing Novell NetWare 4.1

- 1 Begin the procedure for installing Novell NetWare 4.1, as explained in your NetWare documentation.
- 2 When the Choose the Server Drivers - Network Driver screen appears, press **Insert** to install an unlisted driver.

- 3 Insert the *ALANE Driver for Novell NetWare v1.0* diskette in a diskette drive.
- 4 If the diskette is in drive A, press **Enter**. If the diskette is in a different location, press **F3** to specify another path.  
The system scans for available drivers.
- 5 From the Select a driver to install menu, select ALANE.LAN and press **Enter**.
- 6 From the Board ALANE\_1 (Driver ALANE) Actions menu, select Select/Modify driver parameters and protocols and press **Enter**.
- 7 Press **F3** to manually set IPX frame types.
- 8 From the Frame Type List, select the appropriate frame type(s) and press **F10**.
- 9 In the ALANE\_1 Parameters section, configure the LANE Client by changing the following parameters, as needed.

Parameter	Default Value	Possible Values	Description
MAXIMUM TRANSFER RATE	1516	1516, 4544, 9234, 18190	Specifies the maximum transfer size the ELANE supports.
ELANE ID	0	0, 1, 2, 3	Identifies the slot occupied by the ELANE. The ANA-5910/5930/5940 supports up to 4 emulated LANs, numbered 0–3.
DCS_FEATURE	on	on, off	Enables dynamic channel sharing (DCS), which allows ATM to transmit channels to load-balance network traffic.

*Installing ATM Software for Novell NetWare*

<b>Parameter</b>	<b>Default Value</b>	<b>Possible Values</b>	<b>Description</b>
Signalling ATM Adaptation layer version number	30	30, 31	Specifies the ATM signaling adaptation layer, or QSAAL version number.
Signalling Stack version number	30	30, 31	Specifies the ATM signaling stack, or Q93B version number.
Want to Specify LES_ADDR?	no	no, yes	Specifies if the LEC has to register directly to the LES.
LECS Address (Network Port)	<sup>1</sup> Well-known LECS address	Network NSAP; up to 26 characters	Specifies the first 13-byte network portion of the NSAP address for the LECS.
LECS Address (ESI Port)	<sup>2</sup> Well-known LECS address	ESI NSAP; up to 14 characters	Specifies the last 7-byte end system identifier (ESI) portion of the NSAP address for the LECS.
LES Address (Network Port)		Network NSAP; up to 26 characters	Specifies the first 13-byte network portion of the NSAP address for the LES.
LES Address (ESI Port)		ESI NSAP; up to 14 characters	Specifies the last 7-byte ESI portion of the NSAP address for the LES.
ELAN Name	default	Up to 25 characters	Specifies the ELAN name for the LES.

<sup>1</sup> 47007900000000000000000000000000

<sup>2</sup> 00a03e00000100

- 10 From the Board ALANE\_1 (Driver ALANE) Actions menu, select **Save parameters and continue** and press **Enter**.

The following message appears:

Do you want to select an additional Network driver?

- 11 Complete one of the following steps:
  - a If you do not want to install additional drivers, select **No** and press **Enter**.
  - b If you want to install additional drivers, select **Yes** and press **Enter**.

The Select a driver to install menu appears. Refer to your Novell NetWare documentation for information about installing drivers from other manufacturers.

- 12 In the Choose the Server Driver - Summary screen, select **Continue installation** from the Driver Options menu and press **Enter**.
- 13 Continue with the Novell NetWare 4.1 installation procedure.

## Installing and Configuring the ATM Software After Installing NetWare 4.1

To install the Adaptec ATM software for Novell NetWare 4.1

- 1 Boot the server.
- 2 At the server system console prompt, type the following command and press **Enter**:  
load install
- 3 From the Installation Options menu, select **Driver options** and press **Enter**.
- 4 From the Driver Options menu, select **Configure network drivers** and press **Enter**.
- 5 From the Additional Driver Actions list, select **Select a driver** and press **Enter**.
- 6 At the Select a driver menu, press **Insert** to install an unlisted (the Adaptec ATM) driver.
- 7 Press **F3** to specify another path.

The system scans for available drivers.

- 8 In the Specify a directory path screen, type the following path and press **Enter**:

A:\

- 9 Insert the *ALANE Driver for Novell NetWare v1.0* diskette in a diskette drive, verify the directory path, and press **Enter**.
- 10 From the Select a driver to install menu, select ALANE.LAN and press **Enter**.
- 11 At the Do you want to copy driver ALANE.LAN?, select **Yes** and press **Enter**.

The system copies the Adaptec ATM software from the diskette to the hard disk drive.

- 12 From the Board ALANE\_1 (Driver ALANE) Actions menu, select **Select/Modify driver parameters and protocols** and press **Enter**.
- 13 Press **F3** to manually set IPX frame types.
- 14 From the Frame Type List, select the appropriate frame type(s) and press **F10**.
- 15 From the ALANE\_1 Protocols menu, select any other protocols needed, such as TCP/IP or AppleTalk, and press **Enter**.
- 16 In the ALANE\_1 Parameters section, configure the LANE Client by changing the following parameters, as needed.

Parameter	Default Value	Possible Values	Description
MAXIMUM TRANSFER RATE	1516	1516, 4544, 9234, 18190	Specifies the maximum transfer size the ELANE should support.
ELANE ID	0	0, 1, 2, 3	Identifies the slot occupied by the ELANE. The ANA-5910/5930/5940 supports up to 4 emulated LANs, numbered 0-3.

Parameter	Default Value	Possible Values	Description
DCS_FEATURE	on	on, off	Enables dynamic channel sharing (DCS), which allows ATM to transmit channels to load-balance network traffic.
Signalling ATM Adaptation layer version number	30	30, 31	Specifies the ATM signaling adaptation layer, or QSAAL version number.
Signalling Stack version number	30	30, 31	Specifies the ATM signaling stack, or Q93B version number.
Want to Specify LES_ADDR?	no	no, yes	Specifies if the LEC has to register directly to the LES.
LECS Address (Network Port)	<sup>1</sup> Well-known LECS address	Network NSAP; up to 26 characters	Specifies the first 13-byte network portion of the NSAP address for the LECS.
LECS Address (ESI Port)	<sup>2</sup> Well-known LECS address	ESI NSAP; up to 14 characters	Specifies the last 7-byte end system identifier (ESI) portion of the NSAP address for the LECS.
LES Address (Network Port)		Network NSAP; up to 26 characters	Specifies the first 13-byte network portion of the NSAP address for the LES.
LES Address (ESI Port)		ESI NSAP; up to 14 characters	Specifies the last 7-byte ESI portion of the NSAP address for the LES.
ELAN Name	default	Up to 25 characters	Specifies the ELAN name for the LES.

<sup>1</sup> 4700790000000000000000000000

<sup>2</sup> 00a03e00000100

*Installing ATM Software for Novell NetWare*

- 17 From the Board ALANE\_1 (Driver ALANE) Actions menu, select Save parameters and load driver and press **Enter**.

The following line appears:

Network number to bind IPX to ALANE\_1 (frame  
Ethernet\_802.2):

- 18 At the system prompt, type your IPX network number and press **Enter**.

The following message appears:

Do you want to select an additional Network driver?

- 19 Complete one of the following steps:
  - a If you do not want to install additional drivers, select **No** and press **Enter**.
  - b If you want to install additional drivers, select **Yes** and press **Enter**.

The Select a driver to install menu appears. Refer to your Novell NetWare documentation for information about installing drivers from other manufacturers.
- 20 From the Additional Driver Actions menu, select Return to the previous menu and press **Enter**.
- 21 From the Driver options menu, select Return to the previous menu and press **Enter**.
- 22 From the Installation Options menu, select Exit and press **Enter**.
- 23 From the Exit INSTALL menu, select Yes and press **Enter**.

## Automatically Loading the ATM Driver

When you install the ATM software, the installation program configures the server to automatically load the ATM driver at system boot. During installation, the following line is added to the *autoexec.ncf* file:

```
sys:\system\atms.ncf
```

If you do not want the ATM driver to automatically load at system boot, comment out the `sys:\system\atms.ncf` line.

## Manually Loading the ATM Driver

To manually load the ATM driver for both Novell NetWare 3.12 and 4.1

- 1 Comment out the `sys:\system\atms.ncf` line in the *autoexec.ncf* file.
- 2 Bring down the server.
- 3 Boot the server.



- 4 At the server system console prompt, type the following command and press **Enter**:  

```
load alane elan_id=n
```

where *n* is the ELAN ID number.
- 5 At the Enter ELAN ID (0-3) prompt, type 0 (for the first ELAN) and press **Enter**.  
Several messages appear on the screen. The last message should read as follows:  

```
alane0: N7500 ELAN is Active
```

## Removing ATM Software

This section contains instructions for removing ATM drivers for Novell NetWare 3.12 and 4.1.

### Removing ATM Software for NetWare 3.12

To remove the Adaptec ATM software for Novell NetWare 3.12

- 1 Type the following command at the system prompt, and press **Enter**:  

```
load edit
```
- 2 In the File Edit screen, type the following command at the system prompt and press **Enter**:  

```
sys:\system\autoexec.ncf
```

The File SYS:\SYSTEM\AUTOEXEC.NCF screen appears.
- 3 Delete the following command:  

```
sys:\system\atms.ncf
```
- 4 Save and exit the file.

## Removing ATM Software for NetWare 4.1

To remove the Adaptec ATM software for Novell NetWare 4.1

- 1 Boot the server.
- 2 At the server system console prompt, type the following command and press **Enter**:  
    load install
- 3 From the Installation Options menu, select Driver options and press **Enter**.
- 4 From the Driver Options menu, select Configure network drivers and press **Enter**.
- 5 From the Additional Driver Actions list, select Deselect a selected driver and press **Enter**.  
  
    If only one ATM driver is installed, the Unload driver anyway? menu appears. Go to step 8.  
  
    If two or more drivers are installed, the Selected Network Drivers menu appears. Go to the next step.
- 6 From the Selected Network Drivers menu, select the driver you want to remove and press **Enter**.
- 7 From the Unload driver anyway? menu, select **Yes**.
- 8 When the message screen appears, press **Enter**.
- 9 From the Additional Driver Actions menu, select **Return to the previous menu** and press **Enter**.
- 10 From the Driver options menu, select Return to the previous menu and press **Enter**.
- 11 From the Installation Options menu, select **Exit** and press **Enter**.
- 12 From the Exit INSTALL menu, select **Yes** and press **Enter**.

## **Updating ATM Software**

This section contains instructions for updating ATM software for Novell NetWare 3.12 and 4.1.

### **Updating ATM Software for NetWare 3.12**

To update ATM software for NetWare 3.12

- 1** Follow the instructions in *Installing the ATM Software* on page 8-1.
- 2** When prompted to overwrite existing files, select Yes.
- 3** Configure the software by following the procedure in *Configuring the ATM Software* on page 8-3.

### **Updating ATM Software for NetWare 4.1**

To update ATM software for NetWare 4.1, follow the instructions in *Installing and Configuring the ATM Software After Installing NetWare 4.1* on page 8-10.

## Troubleshooting

This section provides status commands and explains various status/error messages.

### Status Commands

Use the following commands to determine ATM software status:

<code>aatmncfg -p</code>	Shows the status of the ATM driver
<code>alancnfg -p</code>	Shows the LAN Emulation status

### Status/Error Messages

As the ATM driver is loading, status/error messages are logged to the console.

The message

```
WARNING: ATMS_SIG: QSAAL Transport Layer Up
```

Indicates that the ATM NIC is registered to the switch using ILMI signaling.

The message

```
alane0: N7500 ELAN is Active.
```

Indicates that the ATM LAN Emulation driver is up.

The message

```
atms_addr_reg_timer: No reply from UME:  
aatms_get_rev_mp( ) returns null [1] Address retrieval error
```

Indicates a failure with switch registration. Check the connection to the switch.

The message

```
Retrying to Activate ELAN.
```

Indicates failure with LAN Emulation registration. Check the configuration for LAN Emulation in the ATM NIC and ATM switch.

The message

```
WARNING: E1018 ATMS_SIG: QSAAL Transport Layer Down
```

Indicates a lost of failed connection to the switch. Check the connection.

## Identifying Files

The following files are included on the *ALANE Driver for Novell NetWare v1.0* diskette:

<i>adptcnfg.nlm</i>	Used to view the status of the driver
<i>alane.lan</i>	Operates the Adaptec ATM NIC
<i>alane.lidi</i>	Used to install NLM on NetWare 4.1
<i>atms.ncf</i>	Contains the load/bind commands
<i>nwsetup.nlm</i>	Used to install software on NetWare 3.12
<i>readme.txt</i>	Contains additional installation, loading, and troubleshooting information

## Installing Patches

Obtain and install the following patches before you install the Adaptec ATM software for Novell NetWare:

- Novell NetWare 3.12
  - *312pt3.exe* (OS patches)
  - *landr7.exe* (Ethertsm/msm/NDI)
- Novell NetWare 4.1
  - *410pt3.exe* (OS patches)
  - *landr7.exe* (Ethertsm/msm/NDI)







# Product Features and Specifications

This chapter provides an overview of the Adaptec ANA-5910/5930/5940 adapter features. This chapter also includes a list of product specifications.

## Features

### ANA-5910/5930/5940 Hardware

The ANA-5910/5930/5940 adapter is an ATM network interface card (NIC) designed to be easily installed in the PCI slots. The adapter is specifically designed to enhance your computer's performance by providing easy access to ATM networks. The adapter models use the following cables and connectors:

Adapter	ATM Network Cable Type	Connector	Max. Cable Length	Transfer Rate (Mbits/sec)
ANA-5910	Category 3 or better Unshielded Twisted Pair Copper Cable (UTP-3 or better) and Type 1 Shielded Twisted Pair (STP) Copper Cable	RJ-45 Shielded	100 m	25.6

<b>Adapter</b>	<b>ATM Network Cable Type</b>	<b>Connector</b>	<b>Max. Cable Length</b>	<b>Transfer Rate (Mbits/sec)</b>
ANA-5930	Category 5 Unshielded Twisted Pair Copper Cable (UTP-5)	RJ-45 Shielded	100 m	155.0
ANA-5940	Multimode Fiber (MMF)	62.5/125 SC	2 km	155.0

The adapter delivers high performance in terms of low latency, high throughput, and fast response time. The adapter supports simultaneous inbound and outbound transfers at their maximum line speed of either 25 Mbits/sec for the ANA-5910 or 155 Mbits/sec for the ANA-5930/5940.

One of the adapter's most important functions is to perform the segmentation and reassembly of data for communication with the ATM network. The adapter segments outgoing PDUs into ATM cells and transmits them to an ATM switch for forwarding to their destination. The adapter uses AAL 5 protocol to map PDUs into the information field of the ATM cell. The adapter also reassembles incoming cells into a larger frame and uses a buffer management scheme for the efficient transfer of PDUs between the adapter and the host computer.

At the physical layer, the ANA-5930/5940 supports the SONET/SDH and STS-3c/STM-1 155-Mbit/sec physical transport standards. The ANA-5910 conforms to the ATM Forum's 25.6-Mbit/sec standard transmission method.



## **ANA-5910/5930/5940 Software**

The adapter is shipped with the following software:

- An ATM driver (*atmo.sys*) provides driver layer access to higher layer ATM drivers and resides in the host computer where the adapter is installed. This driver allows Classical IP operation over ATM using RFC 1577.
- An ATM Address Resolution Protocol (ATMARP) server driver (*arp.sys*) allows Classical IP management and creation of SVCs from an ATMARP server. This driver software is an additional package; only one is needed per logical IP subnet (LIS).
- Command-line utilities allow driver configuration at the MS-DOS command line.
- A command-line diagnostic utility (*aatmdiag.exe*) allows testing of the adapter and the ATM connection.
- A Simple Network Management Protocol (SNMP) agent interfaces with networking management software such as HP OpenView or SunNet Manager. The SNMP agent files include *aatmsnmpd.dll*, *ilmi.snm.mib*, and *ilmi.hpov.mib*.

## Features Summary

The following table contains a summary of the features for the adapter. Some of these features have not been described in detail anywhere in this user's reference:

General Features	ATM Connectivity and Features
<p>Highly integrated components for maximum life</p> <p>Onboard high-speed memory, either 512 KByte</p> <p>Software diagnostics with cell error statistics reporting</p> <p>LED on the ANA-5930/5940 lights when the ATM cable is connected to the active adapter and another active ATM device or loopback mode</p> <p>Supports high bandwidth applications for video, voice, image, and data communication</p> <p>Meets all regulatory agency requirements for world-wide distribution</p>	<p>Physical media support:</p> <ul style="list-style-type: none"> <li>■ STP, UTP-3, or better copper cable up to 100 meters on the ANA-5910</li> <li>■ UTP-5 copper cable up to 100 meters on the ANA-5930</li> <li>■ MMF optical interface up to 2 KMeters with the SC connectors on the ANA-5940</li> </ul> <p>Data Transfer Rate Over ATM Network:</p> <ul style="list-style-type: none"> <li>■ 25.6 Mbits/sec on the ANA-5910</li> <li>■ 155 Mbits/sec on the ANA-5930/5940</li> </ul> <p>Up to 1024 virtual channel identifiers (VCIs) depending on your implementation</p> <p>VC multiplexing</p> <p>AAL 5 PDU data format and non-AAL5 as raw cells</p> <p>Up to 8 transmit channels simultaneously with traffic shaping</p> <p>F4 and F5 Flow Operations and Maintenance (OAM) cells are supported</p> <p>User-selectable PCR on each PVC</p>

### Product Features and Specifications

General Features	ATM Connectivity and Features
<b>PCI Connectivity and Features</b>	
32-bit PCI data bus interface 32-bit and limited 64-bit dual address cycle addressing Bus Master, DMA data transfer	PCI bus clock speed of up to 33 MHz PCI transfer rate: 32-MByte/sec peak Single slot usage, short PCI-standard form factor, 6.075" x 4.2" for ANA-5910 and 6.875" x 4.2" for ANA-5930/5940

## Specifications

The adapter complies with applicable ATM Forum specifications and its specifications conform to the PCI standards.

### Environment

<b>Power dissipation</b>	Not to exceed 15 Watts
<b>Operating temperature</b>	0 to 55 °C
<b>Humidity</b>	20 to 90% noncondensing

### PCI Interface

<b>Size</b>	Short PCI-standard form factor: 6.075" x 4.2" for ANA-5910 6.875" x 4.2" for ANA-5930/5940
<b>Frequency</b>	Up to 33 MHz
<b>Bus master</b>	32-bit bus master capability, up to 256-byte burst size
<b>Rate tolerance</b>	±100 ppm

## UTP and STP Interface (ANA-5910/5930)

<b>Connector</b>	RJ-45 shielded style interface
<b>Oper. Distance</b>	100 meters
<b>ANA-5910 cable</b>	EIA/TIA UTP-3, 4, 5: 100 ohm STP type 1, 1A, 2, 2A: 150 ohm Data rate: 25.6 Mbits/sec Line code: NRZI
<b>ANA-5930 cable</b>	UTP-5: 100 ohm Data rate: 155.52 Mbits/sec Line code: NRZ

Pin contacts are listed here for the STP, UTP-3, UTP-4, and UTP-5 cables:

ANA-5910 <sup>1</sup> / IBM Defacto Pinout Standard		Pin Contact	ANA-5930/ ATM Forum Pinout Standard	
ATM Workstation/ ANA-5910 Signal	ATM Network/ Switch Signal		ATM Workstation/ ANA-5930 Signal	ATM Network/ Switch Signal
Unused	Unused	1	Transmit A	Receive A
Unused	Unused	2	Transmit B	Receive B
Transmit A	Receive A	3	Unused	Unused
Receive A	Transmit A	4	Unused	Unused
Receive B	Transmit B	5	Unused	Unused
Transmit B	Receive B	6	Unused	Unused
Unused	Unused	7	Receive A	Transmit A
Unused	Unused	8	Receive B	Transmit B

<sup>1</sup> If your ATM switch is ATM Forum pinout compliant, create a cable to convert to the pinouts; see Figure on page A-7.

### Product Features and Specifications

If you need to make a UTP cable to convert between the IBM Defacto and ATM Forum pinout standards, redirect the pin contacts as shown in Figure .

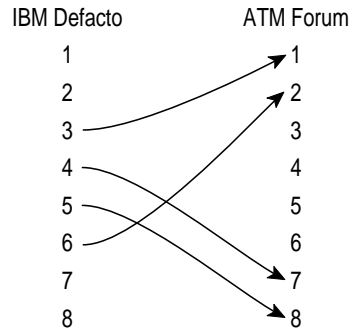

Figure A-1. IBM Defacto to ATM Forum Standard Cable Conversion

### MMF Optical Interface (ANA-5940)

<b>Connector</b>	SC-style optical interface
<b>Core diameter</b>	62.5 micron
<b>Cladding diameter:</b>	125 micron
<b>Min. modal bandwidth</b>	500 MHz-km
<b>Operating distance</b>	0 to 2 km
<b>Line code</b>	NRZ
<b>Data rate</b>	155.52 Mbits/sec

#### Receiver

<b>Minimum sensitivity</b>	-30 dBm
<b>Maximum overload</b>	-14 dBm
<b>Path power penalty</b>	1 dB

**Transmitter**

<b>Transmitter type</b>	LED
<b>Wavelength</b>	1260 to 1360 nm
<b>Spectral width</b>	75 nm RMS
<b>Mean launched power</b>	-20 to -14 dBm
<b>Min. extinction ratio</b>	10 dB
<b>Max. rise time</b>	3 ns





# Windows NT Specific Error Messages and Diagnostics

## **Error Messages**

Error messages are divided into the following sections:

- *User Error Messages*
- *Diagnostics Error Messages*
- *Driver Console Error Messages*

## User Error Messages

User error messages appear at the command tool or shell tool windows.

Error Message	Description
aatm,ume: Address Registration Completed	The <i>atmo.sys</i> driver registered to the switch successfully. <b>Note:</b> For the Bay Networks Switch, the driver registration can take up to three tries. The aatm,ume: Address Registration Completed error message appears until the address has registered with the switch. If after three tries, the address cannot register, check the ATM cables, and check the switch. The problem may occur with only one port at a time, and may occur at another port at a different time.
aatm,ume:Link down, no response from switch	The link is down between the adapter and the switch. Check the cable connection between the adapter and switch; then check the switch.
aatm,ume: Retrying...	The <i>atmo.sys</i> driver is trying to register to the switch again.
aatm,ume: Timeout Waiting For Network Prefix From Switch	The driver attempted to register to the switch, but failed because the switch did not send the network prefix during the time set by the timeout value in the configuration file.
atmo.sys, unable to bind.	Make sure that the VCI numbers are the same in <i>acip.db</i> and <i>base.db</i> . If the numbers do not match, the driver is not able to bind.
Error in Address registration, will retry Address registration failed. exiting	The driver could not register with the switch and failed.
Error Opening File <ConfigFile> Unable to open configuration file	The driver could not open the specified configuration file.



### Windows NT Specific Error Messages and Diagnostics

Error Message	Description
ioctl link failure	An error was encountered while doing I_PLINK or I_PUNLINK between <i>aarp.sys</i> , and <i>atmo.sys</i> drivers.
Value <value> out of bounds	The value in the configuration file is out of bounds.

### Diagnostics Error Messages

Diagnostic error messages appear at the command line when running the *aatmddiag.exe* program.

Diagnostic Error Message	Description
Error: Invalid loop count entered. Must be positive integer number	A negative or zero loop count is invalid for the loop command.
Error: Unable to setup diagnostics. Check if atmo driver is busy	<p>The driver is busy; several possible causes are listed below:</p> <p>Another application is using the <i>atmo.sys</i> driver (another <i>aatmddiag.exe</i> is currently active). Terminate the application using the <i>atmo.sys</i> driver. For Classical IP, use <i>acipcnfg.exe</i>. For an active ARP, use <code>net stop aarp</code>.</p> <p>An invalid controller number was specified while invoking <code>aatmddiag -c #</code>. Valid controller numbers range from 0 to N, where N is equal to the total number of physical boards in the system minus 1. Only one adapter is supported in a system at this time (enter 0).</p> <p>The <i>atmo.sys</i> driver was not loaded properly. Reconfigure the driver or reinstall the driver.</p>
SYSTEM Error: No such file or directory File: X	The file does not exist when using the <code>aatmddiag -f X</code> option. Make sure this file exists.

Diagnostic Error Message	Description
Test failed on test count= xxx	Message printed when a test fails in loop mode. xxx is the number of tests that ran before the error occurred. For example, if three tests are executed in loopmode with the following error message as follows: ADM:0> loop LoopMode> selftest LoopMode> sar_mem_e LoopMode> atm_ext LoopMode> end ATM External Tests FATAL ERROR Test failed on test count= 9 Failed test count of 9 indicates that the third execution of test atm_ext failed. The previous three executions of tests selftest and sar_mem_e all passed. Call technical support.
Warning: Invalid Debug level specified	Invalid Debug level was specified with the -d option. Valid values are 0 or 1.
Warning: Syntax Error on command.	An incorrect command syntax was used. Enter <code>aatmdia -h</code> at a command line or help while running the <code>aatmdia</code> utility to get specific details on the correct command syntax.

## Driver Console Error Messages

The `atmoconsole.exe` utility is run from the MS-DOS prompt. To access the MS-DOS prompt from within Windows NT, select the **MS-DOS Command Prompt** icon from Program Manager's Main group window.

To start the console from the current MS-DOS directory, enter the following command:

```
aatmcons
```

To start the console on the separate MS-DOS screen, enter the following command:

```
start aatmcons
```

To exit the console, press **Ctrl+C**.



**Note:** The variable in a message refers to the return code. Also, messages with the same solutions are listed together.

Driver Console Error Message	Description
E1010 ATMO_SIG: UNABLE to GET STATION ADDRESS STOP DRIVER, RESTART aatmcnfg	The software was not able to obtain address of the host from the ILMI module of the driver. Enter aatmcnfg -s to stop the driver, and enter aatmcnfg to restart.
E1011 ATMO_SIG: Q-SAAL GENERAL CONFIG FAILURE E1012 ATMO_SIG: Q-SAAL DATA_LINK CONFIG FAILURE for PORT variable E1013 ATMO_SIG: SIG_VCC create failed for lack of memory E1014 ATMO_SIG: SIG_VCC create failed status variable diag variable E1015 ATMO_SIG: SIG_VCC bind failed for lack of memory E1016 ATMO_SIG: SIG_VCC bind failed status variable diag variable E1017 ATMO_SIG: Resource UnAvailable	These errors occur when there is not enough memory on the system. Increase the amount of memory.
E1018 ATMO_SIG: QSAAL Transport Layer DOWN	This error indicates that QSAAL module of the driver lost connection with the switch. Try stopping the drivers and restarting them.

**ANA-5910/5930/5940 User's Guide**

Driver Console Error Message	Description
<p>E1019 ATMO_SIG: SSCOP (UNI 3.0/3.1): VT(CC) &gt;= MaxCC</p> <p>E1020 ATMO_SIG: SSCOP (UNI 3.0/3.1): Timer_NO_RESPONSE expiry</p> <p>E1021 ATMO_SIG: SSCOP (UNI 3.0/3.1): SD, POLL, or SDP N(S) error</p> <p>E1022 ATMO_SIG: SSCOP (UNI 3.0/3.1): STAT N(PS) error</p> <p>E1023 ATMO_SIG: SSCOP (UNI 3.0/3.1): STAT N(R) or list elements error</p> <p>E1024 ATMO_SIG: SSCOP (UNI 3.0/3.1): USTAT N(R) or list elements error</p> <p>E1025 ATMO_SIG: SSCF (UNI 3.0 only): Misuse of SSCOP, AA-RESYNC.ind received</p>	<p>These messages, preceded by E1018, are for informational purposes. No action is required.</p>
<p>E1040 ATMO_SIG: Q-93B GENERAL CONFIG FAILURE</p> <p>E1041 ATMO_SIG: Q-93B DATA_LINK CONFIG FAILURE for PORT variable</p> <p>E1042 ATMO_SIG: Q-93B SERVICE LAYER CONFIG FAILURE for PORT variable</p> <p>E1046 ATMO_SIG: Resources unavailable - out of memory</p>	<p>These errors occur when there is not enough memory on the system. Increase the amount of memory.</p>
<p>E1044 ATMO_SIG: Primitive received with invalid SAP id</p>	<p>This error, while not fatal, indicates that users are trying to use SVCs without valid parameters. This message is useful for debugging when the Classical IP portion of the driver is not working.</p>
<p>E1043 ATMO_SIG: SAP down - max number of RESTARTS sent on PORT variable</p> <p>E1045 ATMO_SIG: Virtual channel (variable) down maximum number of Restarts sent</p>	<p>These messages indicate that signalling has encountered problems with the switch. Stop the driver, then restart it.</p>

**Windows NT Specific Error Messages and Diagnostics**

Driver Console Error Message	Description
P0000 ATMO_ALP: nic_free_seg(), segment out of range P0001 ATMO_ALP: nic_free_seg(), segment is not aligned P0002 ATMO_ALP: nic_free_seg(), segment is in use	The <i>atmo.sys</i> driver while closing a virtual circuit, detected some adapter queue errors from which it cannot recover. Reboot the computer.
W0106 ATMO_ALP: nic_sar_init(), can't allocate VCI tables W0107 ATMO_ALP: nic_sar_init(), can't allocate DMA RCV queue W0108 ATMO_ALP: nic_sar_init(), can't allocate DMA XMT queue W0109 ATMO_ALP: nic_sar_init(), can't allocate SVC LST W0110 ATMO_ALP: nic_sar_init(), not get best_effort XMT	Space could not be allocated in the adapter memory for the particular request. Reboot the computer and try initializing the driver again by running <i>aatmconf.exe</i> . If you still get the same error, call technical support.
W0127 ATMO_ALP: No user is found	This message alerts the system administrator that the driver received some incoming messages from the network after the client for whom the message came had detached its stream to the driver. No action is required.
W0128 ATMO_ALP: alp_aal5_unitdata_req BAD PDU size variable W0129 ATMO_ALP: alp_cell_unitdata_req BAD PDU size variable	The AAL 5 or non-AAL 5 client software driver using the ALP driver is trying to send a PDU which is either too big (bigger than the MTU size) or too small (size 0). Make sure that the MTU size configured for Classical IP or the non-AAL 5 client is consistent with the value configured for the ALP driver.
W0131 ATMO_ALP: nic_xmtdodma: data out mismatch: variable	The number of octets in the message buffer to be transmitted is inconsistent with that in the transmit PDU descriptor. This error should not occur in normally functioning software. The computer will most likely recover from this error by itself.

**ANA-5910/5930/5940 User's Guide**

Driver Console Error Message	Description
W0132 ATMO_ALP: nic_proc_xmt_complete() room too large, room variable	The available room in the transmit queue on the adapter has become larger than the configured value. Reboot the computer. If you see this message again, call technical support.
W0133 ATMO_ALP: nic_proc_xmt_complete() logic error:	The driver received an interrupt that indicated that a PDU had just been transmitted. However nothing is in the PDU queue to be transmitted. Reboot the computer. If you see this message again, call technical support.
W0135 ATMO_ALP: BAD RCV reinitialize W0137 ATMO_ALP: nic_service_vcc: rcv BAD: variable W0138 ATMO_ALP: rsi_descstart BD: variable rcv_descstart variable	The adapter is being reset because of some hardware errors. No action is required; the computer will recover by itself. A lost packet may be observed by the applications.
W0139 ATMO_ALP: WRONG RCV buffer size: variable	Because of an error in the software/hardware, the calculated size of an incoming PDU is larger than the adapter's receive segment size. The adapter will reset and the computer should recover by itself.
W0140 ATMO_ALP: nic_rcv_seg_copyin: BAD count: variable	There is an inconsistency in the number of bytes being slave copied. No action is required. However, if you repeatedly see this message, call technical support.
W0142 ATMO_ALP: nic_proc_error() enter	The adapter is resetting because of some hardware errors. No action is required on the part of the administrator or users. The computer will recover by itself. A lost packet may be observed by the applications.

**Windows NT Specific Error Messages and Diagnostics**

Driver Console Error Message	Description
<p>W1218 ATMO_SIG: SSCOP (UNI 3.1 only): Credit obtained</p> <p>W1212 ATMO_SIG: SSCOP (UNI 3.0/3.1): RSAK</p> <p>W1301 ATMO_SIG: Primitive (variable) incompatible with SAP state</p> <p>W1302 ATMO_SIG: Primitive (variable) unknown</p> <p>W1303 ATMO_SIG: Primitive (variable) has invalid parameters</p>	<p>These warning messages are non fatal. The driver prints them to provide information. These messages usually precede error messages.</p>
<p>W1304 ATMO_SIG: Trying to Reconnect to the switch</p>	<p>This message is printed following message E1018. The driver is trying to establish a connection with the switch. This message is non fatal. Stop the driver and restart it. If this does not help call technical support.</p>
<p>W3100 ATMO_DIAG: Adaptec ATM NIC hardware Diagnostics failed! Run 'aatmdiag' for failure details.</p>	<p>Diagnostics selftest detected a hardware problem when the <i>atmo.sys</i> driver was initially configured using <i>aatmconf</i>. Run the command line utility <i>aatmdiag</i> for more details on which diagnostics test failed. See <i>Diagnostics</i> on page B-11 for command usage.</p>
<p>W3200 ATMO_DIAG: System Memory allocation failed. Re-run command.</p> <p>Note: Error messages W5101 to W5430 are used for both <i>atmo.sys</i> and <i>arp.sys</i> drivers. The messages display as WARNING: ACIP W5152 (2,1,2): startup failed.</p>	<p>Diagnostics attempted to allocate system memory that was not available. Restart the command line utility that failed (e.g., <i>aatmconf.exe</i>). If the problem persists, terminate applications that consume kernel memory to free up memory space.</p>
<p>W5152 startup failed</p>	<p>The startup procedure failed. Another message will appear giving the reason.</p>
<p>W5153 shutdown failed</p>	<p>The shutdown procedure failed. Another message will appear giving the reason.</p>

**ANA-5910/5930/5940 User's Guide**

Driver Console Error Message	Description
W5154 incompatible configuration program	The wrong version of <i>acipcnfg.exe</i> or <i>aarpcnfg.exe</i> is being used.
W5155 lis already started	An attempt was made to start the LIS while it was already started. If you want to change the configuration of the LIS, stop the driver, configure it, and then restart it.
W5156 is already shutdown	An attempt was made to shut down the LIS while it was already shut down. No action is required.
W5160 out of memory	Occurs if all system memory has been used up; generally occurs if a fast machine is streaming data to a slow machine, or some other mismatch in application or machine speed occurs causing the slower one to be overloaded. Change the system resource parameters or allow fewer users to use your system at one time.
W5301 arp lookup failed - check pvc configuration	In a PVC only environment, look up the ATMARP table for the destination IP address failed. As there is no ATMARP server in a PVC only environment, the destination is unreachable. Check that the VPI/VCI numbers are the same on the end points and on the switch.
W5310 no source ip address in arp message W5311 remote station claiming same ip address W5312 message from wrong subnet received	An invalid ATMARP or inverse ATMARP message was received. Check for conflicts between the IP addresses assigned to each interface. All IP stations must have the same address prefix, that is, be in the same subnet, for a Classical IP LAN. IP stations in different subnetworks must communicate via a router.



*Windows NT Specific Error Messages and Diagnostics*

Driver Console Error Message	Description
W5350 received packet is not ip or arp	A packet was received that is not IP or ARP. Check the ATM address and selector assignment to see if <i>atmo.sys</i> or <i>aarp.sys</i> could be receiving packets for another application , for example, LAN Emulation, by mistake.
W5401 pvc bind failed	There is a mismatch between the PVCs configured for Classical IP and for <i>atmo.sys</i> . Make sure that the VPI/VCI numbers in the <i>acip.db</i> and <i>base.db</i> files are consistent.
W5410 SETUP received - invalid called atm address W5411 SETUP received - cannot find matching subnet W5412 SETUP received - invalid calling atm address W5413 SETUP received - invalid aal5 parameters W5414 SETUP received - invalid blli W5415 SETUP received - invalid vpi / vci W5420 CONNECT received - invalid aal5 parameters W5421 CONNECT received - invalid vpi / vci W5430 CALL PROCEEDING received - invalid vpi / vci	An invalid signalling message for Classical IP was received. Check the configuration of other stations for consistency. All IP stations must use the same MTU size—no MTU negotiation is performed. Receiving a different value to that configured will result in the invalid aal5 parameters error. Also check the ATM address and selector assignment.

## Diagnostics

The hardware diagnostic utility *aatmdiag.exe* is a command-line interface that can be used to validate that the adapter is functioning properly. Only three commands are needed to completely test the adapter. These are the selftest, extended SAR memory tests, and the external ATM tests (using an external loopback cable).



---

**Note:** The selftest and SAR memory tests check most of the functionality on the adapter. To test all functions on the adapter, use a loopback cable and run the external ATM test.

---

To verify that the adapter is functioning properly, do the following:

- 1 Make sure you have installed the adapter and the drivers. See Chapter 3, *Installing the Adapter*.
- 2 Select the **MS-DOS Command Prompt** icon in the **Main** program group.
- 3 Change to the directory where ATM software is installed. The default is `etc\opt\adptaatm\bin`.
- 4 Stop all the drivers that are running. See *Database File Parameters* on page B-14.
- 5 Start the diagnostic utility by entering the following command:

```
aatmdiag
```

For help, enter `aatmdiag -h` from the MS-DOS command prompt, or type `help` when you are in the diagnostic command utility (at the `ADM:0>` prompt).

When using the loop mode of testing, type `loop`. At the `LoopMode>` prompt, enter the desired test. At the next `LoopMode>` prompt, enter the next desired test. When you have finished, enter `end`. If you wish to display the intermediate pass results of your tests, be sure to enter `log_level 1` before you enter loop mode. For example

```
ADM:0> log_level 1
ADM:0> loop
LoopMode> selftest
LoopMode> sar_mem_e
LoopMode> atm_ext
LoopMode> end
```

- 6 Execute the adapter selftest by entering the following command from the `ADM:0>` prompt:

```
ADM:0> selftest
Self Tests
PASSED
```

*Windows NT Specific Error Messages and Diagnostics*

- 7** Execute the extended SAR memory test by entering the following command from the ADM:0> prompt:

```
ADM:0> sar_mem_e
Extended Segmentation and Reassembly Tests
PASSED
```

- 8** To execute an optional external test, follow these steps:

- a** Remove the ATM cable from the adapter's ATM connector (if one is already connected).
- b** Place an external ATM loopback cable on the adapter's ATM connector. Obtain this cable from your cable vendor.
- c** Test the external ATM connection to the adapter by entering the command from the ADM:0> prompt:

```
ADM:0> atm_external
ATM External Tests
PASSED
```

- d** Remove the loopback cable and reconnect the adapter to your ATM switch.

- 9** Exit the diagnostic program:

```
ADM:0> quit
```

- 10** If all the diagnostic tests passed, restart the drivers you need.

## Database File Parameters

The following table lists the parameters and values in the *base.db*, *acip.db*, and *aarp.db* database files. Not every parameter is used in each of these database files.

Parameter	Description	Possible Values
aatype	AAL type	1 (non-AAL 5); 2 (AAL 5)
addrregmaxretry	address registration maximum retry	0 - 255
addrregtimeout	address registration retry delay time	5 - 255
addrse <sup>l</sup>	ATM address selector	0
appid	application ID name	ASCII string
arp_srv_atm_addr	ATMARP server address in hex	20 bytes separated by dots
atm_selector	ATM selector in hex on which CIP listens	0 - 255
best	best effort	0 or 1
corrupt	receive corrupt data	0 (discard); 1 (accept)
encap	encapsulation	llc; null
ibmoamstart	use IBM 25.6 Mbit/sec concentrator	0 (disable); 1 (enable)
inactivity_time	inactivity timer	0 - 300
ip_address	IP address in decimal	4 bytes separated by dots
ip_netmask	IP netmask in decimal	4 bytes separated by dots
lmaddrregtimeout	address registration timeout	5
netprefix	acceptable network prefix	0
max_mtu	maximum MTU for Classical IP	64 - 65496
nmipaddr	Network Management Station's (ILMI) IP address in decimal	4 bytes separated by dots
pcr	peak cell rate	0 - 100% in base.db 1 - 353208 in aarp.db
portindex	port index for the PVC	0
port_index	ATM adapter index	0
ptimode	OAM mode	1 (discard OAM); 2 (enable OAM)

**Windows NT Specific Error Messages and Diagnostics**

<b>Parameter</b>	<b>Description</b>	<b>Possible Values</b>
qos	quality of service	0; 3; 4
rcvqos	receive quality of service	0 - 4
remote_ip_addr	remote IP address for PVC supporting null encapsulation	4 bytes separated by dots
rxpcr	receive peak cell rate	1 - 353208
rxpdu	maximum receive PDU size	1 - 65536
rxtraftype	receive traffic type	0 (no descriptor); 1 (PCR specified)
saalversion	QSAAL version	30; 31
snmpmaxretry	ILMI request maximum retry	2
snmptimeout	ILMI request timeout	2
svc_supported	support SVC	0 (no support); 1 (support)
swnetprefix	switch network prefix	13 bytes separated by dots
syscontact	ILMI system contact	ASCII string
sysdesc	ILMI system description	ASCII string
sysloc	ILMI system location	ASCII string
sysname	ILMI system name	ASCII string
sysobjid	ILMI system OID	OID string
sys serv	ILMI system service	72
traffic_class	traffic class	ubr; cbr
txpcr	transmit peak cell rate	1 - 353208
txtraftype	transmit traffic type	0 (no descriptor); 1 (PCR specified)
vci	VCI for PVC	0 - 1023
version	signalling version	30; 31
vpi	VPI for PVC	0
xmtpdu	maximum transmit PDU size	1 - 65536
xmtqos	transmit quality of service	0 - 4

## SNMP Agent

This is for network managers and system administrators who will use Simple Network Management Protocol (SNMP) to manage their ATM networks. The ATM Management Information Base (MIB) was created from the ATM Forum UNI 3.1 ILMI MIB specifications. It does not support RFC 1695. The ILMI MIB uses the ASN.1 format which allows you to compile ATM driver modules into your required network management station.

If you are using HP OpenView or SunNet Manager to manage your network, install the MIBs on the computer that will operate as the management station for the ATM network, see *HP OpenView or IBM NetView 6000* and *SunNet Manager* on page B-17. Once this station is set up, other Windows NT computers communicate with it through the Windows NT SNMP Service.

This Windows SNMP Service must be configured on each Windows NT computer in the ATM network; see Windows NT documentation for setting up Windows NT SNMP Service. If you have SNMP Service set up before you install ATM drivers, the SNMP agent is configured during ATM driver installation. If you set up SNMP Service after installing ATM drivers, reconfigure the computer by following these steps:

- 1 Select the **Control Panel** icon in the **Main** program group.
- 2 Select the **Network** icon.
- 3 Select the **Adaptec ATM Adapter** under Installed Adapter Cards. Then select **Configure**.

### HP OpenView or IBM NetView 6000

To compile the MIB for use in HP OpenView or IBM NetView 6000 Network Management, follow these instructions (Adaptec has confirmed that HP OpenView 3.31 and IBM NetView 6000 running on SunOS 4.1.3 operates with our ATM drivers):

- 1 From the Control pull-down menu, select **SNMP Manager**.
- 2 Select **Management Database**.
- 3 Select **ilmi.hpov.mib** in the `etc\opt\adptaatm\bin` directory (or the directory where your ATM software is installed).

**4 Select Add.**

The ILMI MIB is now compiled. For further instructions on using HP OpenView to monitor network traffic, see the HP OpenView documentation.

**SunNet Manager**

To compile and load the MIB into SunNet Manager 2.2.2 or later, follow these instructions. For instructions for other versions, see the documentation that came with SunNet Manager.

- 1** Copy the file *ilmi.snm.mib* from the `etc\opt\adptaatm\bin` directory (or the directory where your ATM software is installed) into your SunNet Manager *agents* directory. This may require copying this file to a different computer or workstation.
- 2** Change to the directory *agents* in your SunNet Manager software directory.
- 3** Use the utility *mib2schema* to generate the *schema* and *oid* files for the MIB:  

```
# mib2schema ilmi.snm.mib  
# build-oid
```
- 4** Enter SunNet Manager to see if the MIB was compiled and loaded.







# ▼▼▼▼ Glossary

This glossary is divided into two sections: *Acronyms* and *Glossary of Terms*.

## Acronyms

<b>AAL</b>	ATM Adaptation Layer	<b>ILMI</b>	Interim Local Management Interface
<b>ANSI</b>	American National Standards Institute	<b>IP</b>	Internet Protocol
<b>API</b>	Application Programming Interface	<b>IPX</b>	Internet Packet Exchange (Novell)
<b>ARP</b>	Address Resolution Protocol	<b>ISDN</b>	Integrated Services Digital Network
<b>ASIC</b>	Application Specific Integrated Circuit	<b>ISO</b>	International Standards Organization
<b>ATM</b>	Asynchronous Transfer Mode	<b>LAN</b>	Local Area Network
<b>B-ISDN</b>	Broadband Integrated Services Digital Network	<b>LATA</b>	Local Access and Transport Area
<b>BEPCR</b>	Best Effort Peak Cell Rate	<b>LED</b>	Light Emitting Diode
<b>CBR</b>	Continuous Bit Rate (voice and video)	<b>LIS</b>	Logical IP Subnetwork
<b>CCITT</b>	Consultative Committee for International Telegraph and Telephone	<b>MAC</b>	Media Access Control
<b>CL</b>	Convergence Sublayer	<b>MAN</b>	Metropolitan Area Network
<b>CLP</b>	Cell Loss Priority	<b>MBS</b>	Maximum Burst Size
<b>DMA</b>	Direct Memory Access	<b>MIB</b>	Management Information Base
<b>EPROM</b>	Erasable Programmable Read Only Memory	<b>MMF</b>	Multimode Fiber
<b>ESI</b>	End Station Identifier	<b>MTU</b>	Maximum Transmission Unit
<b>ETSI</b>	European Telecommunications Standards Institute	<b>NIC</b>	Network Interface Card
<b>GUI</b>	Graphical User Interface	<b>NMS</b>	Network Management Systems
<b>IEEE</b>	Institute of Electrical and Electronics Engineers	<b>NNI</b>	Network-to-Network Interface
<b>IETF RFC</b>	Internet Engineering Task Force Request for Comment	<b>OAM</b>	Operations And Maintenance
		<b>P-NNI</b>	Private Network to Node Interface
		<b>PCI</b>	Peripheral Component Interconnect
		<b>PCR</b>	Peak Cell Rate
		<b>PDU</b>	Protocol Data Units
		<b>PHY</b>	PHYSical Layer
		<b>PMD</b>	Physical (layer) Media Dependent

***ANA-5910/5930/5940 User's Guide***

<b>PTI</b>	Payload Type Identifier	<b>VPC</b>	Virtual Path Connections (set of VCC)
<b>PVC</b>	Permanent Virtual Connection	<b>VPI</b>	Virtual Path Identifier
<b>QoS</b>	Quality of Service		
<b>RFC</b>	Request for Comment		
<b>Rx</b>	Receive		
<b>SAR</b>	Segmentation and Reassembly		
<b>SCR</b>	Sustained Cell Rate		
<b>SDH</b>	Synchronous Digital Hierarchy		
<b>SEAL</b>	Simple and Efficient Adaptation Layer (AAL 5)		
<b>SMF</b>	Single Mode Fiber		
<b>SNMP</b>	Simple Network Management Protocol		
<b>SONET</b>	Synchronous Optical Network		
<b>STM</b>	Synchronous Transfer Mode		
<b>STM -n</b>	Synchronous Transfer Mode [level]		
<b>STP</b>	Shielded Twisted Pair		
<b>STS</b>	Synchronous Transport Signal		
<b>SUNI</b>	Subscriber User-to-Network Interface		
<b>SVC</b>	Switched Virtual Connection		
<b>T1</b>	1.544-Mbit/sec communications circuit divided into 24 64-KByte channels		
<b>T3</b>	45-Mbit/sec communications circuit divided in to 28-T1 Lines		
<b>TC</b>	Transmission Convergence		
<b>TCP</b>	Transmission Control Protocol		
<b>Tx</b>	Transmit		
<b>UDP</b>	UNIX Datagram Protocol (UNIX transport protocol) or User Datagram Protocol		
<b>UME</b>	UNI Management Entity		
<b>UNI</b>	User-to-Network Interface		
<b>UTP</b>	Unshielded Twisted Pair		
<b>UU</b>	User-User identification field		
<b>VBR</b>	Variable Bit Rate		
<b>VC</b>	Virtual Channel		
<b>VCC</b>	Virtual Channel Connections		
<b>VCI</b>	Virtual Channel Identifier		

***Glossary-2***

## **Glossary of Terms**

### **A**

#### **AAL**

ATM Adaptation Layer. One of the three layers of the ATM protocol reference model. It translates incoming data into ATM cell payloads and translates outgoing cells into a format readable by the higher layers. Five AALs have been defined: AAL1 and 2 handle traffic like voice and video which is sensitive to transmission delays, while AAL 3, 4, and 5 pertain to data communications through the segmentation and reassembly of packets.

#### **Analog**

A representation of an object that resembles the original. Analog devices monitor conditions, such as movement, temperature, and sound, and convert them into analogous electronic or mechanical patterns. For example, telephones turn voice vibrations into electrical vibrations of the same shape. Analog implies continuous operation.

#### **ANSI**

American National Standards Institute. The coordinating body for voluntary standards groups within the United States. ANSI is a member of the International

Organization for Standardization (ISO).

#### **API**

Applications Programming Interface. A method of allowing an application to interact directly with certain functions of an operating system or with another application.

#### **ARP (ATM)**

Address Resolution Protocol. A protocol that dynamically maps between various types of addresses (IP addresses to Token Ring addresses for instance) on a local area network.

#### **ASIC**

Application Specific Integrated Circuit. An integrated circuit designed solely for a specific function.

#### **ATM**

Asynchronous Transfer Mode. A form of data transmission based on fixed-length packets, called cells, that can carry data, voice, and video at high speeds. This technology is designed to combine the benefits of switching technology (constant transmission delay, guaranteed capacity) with those of packet switching (flexibility, efficiency for intermittent traffic). ATM is defined by ITU-T specifications.

#### **ATM Layer**

A service-independent layer that sits on top of the PHY Layer. The ATM layer receives the 48-byte SAR-PDU from the AAL Layer,

adds the 5-byte header, then transfers this 53-byte ATM cell to the PHY Layer. Two different formats are used to create the ATM cell—one for the UNI and one for the NNI. The UNI and NNI cell headers are exactly the same except that the UNI replaces the first 4 bits of the VPI field with a GFC field, which is not used at this time.

**ATM Switches**

ATM switches are the heart of ATM technology. ATM switches initially set up the virtual circuit for the end nodes to communicate. Then they route the incoming ATM cells using the VPI/VCI numbers to the appropriate outgoing VPI/VCI and on to the respective node. ATM switches are currently designed with one of two hardware standards: the ATM backplane and the ATM matrix.

**B**

**B-ISDN**

Broadband Integrated Services Data Network. A set of standards under development by the CCITT for services based on ATM switching and SONET/SDH transmission.

**Bandwidth**

The amount of the channel you want to use.

**Best Effort**

The transmission is sent using the highest bandwidth available

to the driver. If you *do not* select Best Effort, your data is sent when all of the specified requirements have been met.

**Bridge**

A device that connects two networks of the same type together. Bridges can usually be made to filter traffic, that is, to forward only certain traffic.

**Broadband**

A method of using the transmission medium's capacity to provide multiple communication channels (as opposed to baseband, where the entire capacity of the medium is used for a single channel).

**C**

**CBR**

Continuous Bit Rate. Used for real time services/data transmissions that accept no or very little delay of the output signal. Video for instance is a continuous bit rate service. See Isochronous.

**CCITT**

Consultative Committee for International Telegraph and Telephone. An international organization that develops communication standards such as Recommendation X.25. Name recently changed to ITU (International Telecommunication Union).

**Cell**

The fixed-length transmission unit used by ATM. Each cell is 53 bytes long with a 5-byte header containing its connection identifier and a 48-byte payload. See CLP, HEC, PTI, and VCI/VPI.

**Cell-Switching**

A technology used by ATM to combine circuit-switching and packet-switching, for a fast and inexpensive way of transmitting various kinds of data.

**Circuit-Switching**

A communication technology that is appropriate for constant bit rate services such as voice and image. It is used by ATM in combination with packet-switching.

**Channel**

Usually refers to PVC or SVC. See PVC, SVC, VC, and VCC.

**Classical IP**

Defined by RFC 1577.

**CLP**

Cell Loss Priority. A 1-bit descriptor found in ATM cell headers, indicating the relative importance of a cell. If set to 0, the cell should not be discarded. If set to 1 the cell may be discarded if there is congestion in the switch.

**Connection-Oriented**

A term used for networking technology that requires a call-setup or connection be

established before sending data. ATM is a connection-oriented technology.

**Connectionless**

A term used for networking technology that does not require a call-setup before sending data.

**Control Plane**

In the B-ISDN protocol reference model, the layer that handles signalling and connection control functions.

**D**

**Double Buffer**

Assigned to receive VCCs on the adapter for reassembly of PDUs. Double Buffer increases the amount of buffer space allocated to a VCC, maximizing throughput while decreasing the number of available VCCs.

**E**

**E1/E3**

The European version of T1/T3. E1 runs at 2.048 Mbits/sec and E3 runs at 34 Mbits/sec.

**EPROM**

Erasable Programmable Read Only Memory. An integrated circuit used to store the host adapter BIOS and firmware. EPROMs can be erased by exposure to ultraviolet light and then reprogrammed with different data.

**Ethernet**

An industry standard (Project 802.3 of the IEEE) that specifies protocols for connection and transmission in local area networks. As a media access method, it operates at layers 1 and 2 in the OSI model. Ethernet transmits at 10 Mbits/sec.

**G**

**Gateway**

1. The original term for what is now called router or more precisely IP router. A gateway connects two different types of communication networks together. It performs the protocol conversion from one network to the other.
2. A communications link between a local area network and a mainframe or mini-computer.

**H**

**HEC**

Header Error Control. The HEC field is an 8-bit CRC computed on all fields in an ATM header and is capable of detecting single-bit and certain multiple-bit errors.

**Hub**

A device that allows a network to be lengthened or expanded with additional nodes.

**I**

**IEEE**

Institute of Electrical and Electronics Engineers. Professional organization that defines some network standards, such as Ethernet.

**ILMI**

Interim Local Management Interface. The standard specification used to manage an ATM network. The ILMI uses the SNMP protocol and an ATM UNI MIB to provide the administrator with status and configuration information.

**INARP**

What RFC 1577 calls RARP.

**Internetwork**

Two or more networks connected by bridges or routers (or both).

**IP**

Internet Protocol. Associated with TCP, a set of communication protocols developed to internetwork dissimilar systems. The TCP protocol controls the transfer of the data (performing at the equivalent of layer 4 in the OSI model) and the IP protocol provides the routing mechanism (performing at the equivalent to layer 3 in the OSI model).

**IP Address**

An identifier for a node, expressed as four fields 1-byte

long separated by decimal points. The IP address is hierarchical, site-dependent and assigned by an administrator.

**IPX**

Internet Packet eXchange. A Novell NetWare communications protocol that is used to route messages from one node to another. The Novell version of IP.

**ISO**

International Organization for Standardization. An organization that sets international standards, founded in 1946 and headquartered in Geneva. ANSI is the US member body to ISO.

**Isochronous**

Signals that are dependent on some uniform timing or carry their own timing information embedded as part of the signal. Voice and video are isochronous signals but data transfer is generally not.

**L**

**LAN**

Local Area Network. A computer network usually incorporating a server and nodes connected by cables all in one building or site.

**LAN Emulation**

How an ATM network emulates enough of the MAC protocol of an existing LAN technology,

such as Ethernet or Token Ring, to allow existing higher layer protocols and applications to be used unchanged over an ATM network.

**8B/10B Line Coding**

Like 4B/5B encoding used by FDDI, 8B/10B is a method for reliable transmission.

**M**

**MAC**

Medium Access Control. For local area networks, the method of determining which device has access to the transmission medium at any time (MAC protocol). The MAC sublayer is a part of the data link layer in the OSI model, that applies a medium access method (like Ethernet or Token Ring for instance).

**MAN**

Metropolitan Area Network. A network formed by the interconnection of two or more networks which may cross administrative boundaries and use multiple access methods. Somewhere between the LAN and the WAN.

**MIB**

Management Information Base. A collection of objects (like statistics for instance) pertaining to the general maintenance of a network, that can be accessed via a network

management protocol.

**MMF/SMF**

Multimode Fiber/Single Mode Fiber. A fiber cable that uses light pulses instead of electricity to carry data. In MMF cable, the light bounces off the cable's walls as it travels down, which causes the signal to weaken sooner and therefore data cannot travel as much distance as with single mode fiber. In SMF cables, the light travels straight down the cable. The size of the most common cable/cladding is 62.5/125 micron for MMF and 8/125 micron for SSF.

**Multicasting**

The ability to send the same message to multiple nodes in a network. LAN technology easily implements this function because it is connectionless. However, ATM must send the same message to various nodes by forming a multipoint connection to all the nodes in the group. In ATM, broadcasting is converted to point-to-multipoint connection.

**Multiplexing**

The transmission of multiple signals over a single communications line or computer channel. The two common multiplexing techniques are Frequency Division Multiplexing, which separates signals by modulating

the data onto different carrier frequencies; and Time Division Multiplexing, which separates signals by interleaving bits one after the other.

**N**

**Network**

A system of connected computers set up to share data, printers, and other devices.

**NMS**

Network Management Systems. NMS is used on both private and public networks to monitor and control management agents.

**NNI**

Network-to-Network Interface. The interface between ATM switches or an ATM switch and an entire switching system. Also called Network-to-Node Interface.

**Node**

An endpoint in a network, typically a workstation or personal computer.

**O**

**Operating System**

The software that controls the basic operation of the host computer. Examples are MS-DOS, UNIX, and Netware.



## **P**

### **P-NNI**

Private Network-to-Node Interface. The interface between two ATM switches or between an ATM switch and an entire switching system in a private network. A Public NNI refers to the interface between an ATM switch in a public network and a switch in either a private or a public network.

### **Packet-Switching**

A communication technology that is appropriate for variable bit rate services such as data and full-motion video. It is used by ATM in combination with circuit-switching.

### **PCI**

Peripheral Component Interconnect. A local bus technology that allows SCSI host adapters, video cards, and other peripherals to send data directly to and receive data directly from the computer's CPU. PCI is a much faster bus than ISA or EISA.

### **PCR**

Peak Cell Rate. A type of ATM traffic flow. The maximum rate at which cells can be transmitted, defined by the minimum possible space between two cells.

### **PDU**

Protocol Data Unit. A generic term for the format used to send

information in a communications protocol, typically a packet with its headers and trailers. Typically, the PDU is passed back and forth between the protocol layers, by the layers themselves.

### **Physical-Layer (PHY)**

Short for Physical Layer. The layer below the ATM layer in the Protocol Reference Model that passes data from the media to the ATM layer and vice-versa. Also refers to OSI Layer 1.

### **PMD**

Physical (layer) Media Dependent. Refers to the part of the NIC's design that has to interface with (and is therefore dependent on) the chosen transmission medium (MMF, UTP, and so forth)

### **Protocol**

Rules for communicating, particularly for the formatting and transmission of data.

### **PTI**

Payload Type Identifier. A 3-bit descriptor found in ATM cell headers, indicating what type of payload the cell contains. Payload types include user and management cells.

### **PVC**

Permanent Virtual Connection/Circuit. A logical (rather than physical) connection between endpoints established by an administrator which stays intact

until manually torn down. See SVC.

## **Q**

### **QoS**

Quality of Service. A set of communication characteristics required by an application. Each QoS defines a specific transmission priority, level of route reliability and security level.

## **R**

### **RFC**

Request For Comment. The document series, begun in 1969, which describes the Internet suite of protocols and related experiments. Not all RFCs describe Internet standards, but all Internet standards are written up as RFCs.

### **Router**

An attaching device that connects LAN segments to other LANs or WANs. Routers operate at the network OSI Layer 3 and transmit data that needs to cross network boundaries. Contrast with bridge. See Gateway.

## **S**

### **SAR**

Segmentation And Reassembly. The function in the ATM Protocol Reference Model that converts the data received from the AAL into ATM cells (one

way) or converts ATM cells into data that can be processed by the AAL (the other way). This function is performed by the SAR chip on the network interface card.

### **SCR**

Sustained Cell Rate. A type of ATM traffic flow. An average of rates at which cells are transmitted over a certain (short) period of time.

### **SDH**

Synchronous Digital Hierarchy. International standard for optical digital transmission at hierarchical rates from 155 Mb/s to 2.5 Gb/s and beyond.

### **Server**

A computer on a network that services other nodes. Also called a back end or engine.

### **Setup Program**

A CMOS-resident configuration utility built into most computers that is used to configure the computer's motherboard and option boards. You typically run the setup program after you install new peripherals, upgrade the computer memory, etc. Configuration information is stored in an EEPROM which retains the data when the computer power is turned OFF.

### **Signaling**

In ATM terms, the process followed to set up switched virtual connections and establish

addresses. The standards in this field are still not fully stable.

**SNMP**

Simple Network Management Protocol. A protocol used to gather activity information on a TCP/IP network for monitoring and statistical purposes.

**SONET**

Synchronous Optical Network. A U.S. and Canadian standard for optical digital transmission at hierarchical rates from 155 Mbits/sec to 2.5 Gbits/sec and beyond.

**SVC**

Switched Virtual Connection/Circuit. A logical (not physical) connection between endpoints established by the ATM network on demand after receiving a connection request from the source/root, which it transmits using the Q.2931 signaling protocol. See PVC.

**T**

**T1/T3**

T1 is a 1.544 Mbits/sec multichannel digital transmission system for voice or data provided by long distance carriers. T3 is similar but operates at 44.736 Mbits/sec. Also referred to as DS1 and DS3 (Data Service).

**TAXI**

A standardized 100 Mbits/sec fiber physical interface for ATM.

**TC**

Transmission Convergence. A sublayer in the ATM physical layer before the PMD. Performs functions as cell delineation, cell rate decoupling, HEC generation and checking and various OAM functions.

**TCP**

Transmission Control Protocol. See IP.

**Token Ring**

An industry standard (Project 802.5 of the IEEE) that specifies protocols for connection and transmission in LANs. As a media access method, it operates at layers 1 and 2 in the OSI model. Token Ring transmits at 4 or 16 Mbits/sec.

**U**

**UNI**

User-Network Interface. Generally described as any connection that directly links a user's device to an ATM network, through an ATM switch. At the ATM layer, the UNI differs from the NNI by replacing the first 4 bits of the VPI with a GFC field.

**UTP/STP**

Unshielded Twisted Pair/Shielded Twisted Pair. Two types of copper cable. STP has insulating material wrapped around the twisted wires for immunity to magnetic interference. UTP (which is the

same as ordinary telephone wire) does not.

## **V**

### **VBR**

Variable Bit Rate. A type of ATM traffic flow. As opposed to Constant or Continuous Bit Rate, VBR traffic may be bursty.

### **VC**

Virtual Channel. A PVC or SVC.

### **VC Multiplexing**

An older protocol that allows you to connect ATM nodes using PVCs (also known as null encapsulation).

### **VCC**

Virtual Channel Connection. A joining of virtual channel links between two endpoints where higher layer protocols are accessed. By definition, ATM cell sequence must be preserved over a VCC.

### **VCI/VPI**

Virtual Channel Identifier/Virtual Path Identifier. ATM addressing information. An identifying value found in the header of each ATM cell.

### **VLAN**

Virtual LAN. A logical collection of member endpoints and network devices grouped together in secure, autonomous domain. Membership in a VLAN is not restricted by physical location. VLANs in

ATM networks may be built upon emulated LANs.

### **VPC**

Virtual Path Connection. A joining of virtual path links between two points in which the VCI values are either reassigned or terminated. Several VCCs may be bundled into one VPC.

## **W**

### **WAN**

Wide Area Network. A physically dispersed collection of LANs.



# ▼▼▼▼ Index

## A

aafmcnfg.exe 4-15, 5-27  
aafmdiag.exe 4-16  
aarpnfg.exe 5-26  
aatmdiag.exe 5-27  
acipcnfg.exe 5-29  
Adaptec  
    software, ordering iii  
    Technical support ii  
Address resolution protocol  
    (ARP) 2-7  
ANA-5910/5930/5940  
    installation of 3-1  
ATM Network  
    25.6 Mbit/sec 2-5  
    bandwidth 2-3  
    description of 2-1  
    node identification 2-3  
atmoconsole.exe 4-18, 5-29

## B

Bandwidth 2-3  
BBS, Adaptec ii  
Broadcast and unknown server  
    (BUS) 2-9

## C

Cable connection  
    ANA-5910 3-4  
    ANA-5930 3-5  
    ANA-5940 3-5  
Cables, SCSI  
    ordering iii

type and model 1-2

CIP ARP server for Windows NT  
    3.51 (optional) 5-21  
CIP ARP server for Windows NT 4.0  
    (optional) 5-9  
Classical IP  
    description of 2-6  
    over ATM 2-7  
Classical TCP/IP  
    description of 2-5

## D

Database file parameters (Windows  
    NT) B-14  
Diagnostics (Windows NT  
    specific) B-11  
Documentation, product,  
    requesting iii

## E

Error messages (Windows NT  
    specific) B-1  
    diagnostics B-3  
    driver console B-4  
    user B-2

## F

Fax system, interactive ii  
Files and directories  
    WindowsNT 4-19  
FTP server ii

## **H**

### Hardware

- installation 3-1
- requirements 1-1
- specifications A-1, A-5
  - ANA-5910 A-1
  - ANA-5930 A-2

### Hardware specifications

- ANA-5940 A-2

## **I**

### Installing software

- Adaptec drivers version 2.0x for Windows NT 3.51 5-13
- Adaptec drivers version 2.0x for Windows NT 4.0 5-1
- Adaptec drivers version 4.0x for windows NT 3.51 4-8
- Adaptec drivers version 4.0x for Windows NT 4.0 4-1
- DOS/Windows 3.1 6-1
- Novell NetWare 8-1
- Windows 95 7-1

### Interactive fax system ii

### Interactive support system ii

## **L**

### LAN emulation

- clients (LECs) 2-8
- configuration server (LECS) 2-9
- description of 2-8
- emulation server (LES) 2-9

## **M**

### MMF optical interface specifications A-7

## **N**

### ndd.exe 5-30

### Node identification 2-3

## **O**

### Ordering information iii

## **P**

### Permanent virtual circuits (PVC) 2-4

### Product

- literature, requesting iii
- support iii

## **Q**

### Quality of service (QoS) 2-4

## **S**

### Sales information iii

### SCSI cables, *See* cables, SCSI

### SNMP Agent B-16

### Software, Adaptec, ordering iii

### Starting ATM drivers (Windows NT) 4-14, 5-25

### Stopping ATM drivers (Windows NT) 4-14, 5-25

### Support

- product iii
- technical ii

### Support system, interactive ii

### Switched virtual connection (SVC) 2-4

### Synchronous digital hierarchy (SDH) 2-4

### Synchronous optical network (SONET) 2-4

### Synchronous transport module (STM) 2-4

### Synchronous transport signal (STS) 2-4

### System requirements 1-1

## **T**

Technical support ii  
Troubleshooting ii

## **U**

UTP and STP interface  
specifications A-6

## **V**

Virtual channel connection  
(VCC) 2-4  
Virtual channel identifier (VCI) 2-4  
Virtual path identifier (VPI) 2-4

## **W**

World Wide Web (WWW) site ii

