

Panasonic®

Facsimile

Panafax® UF-885/895

User's Guide

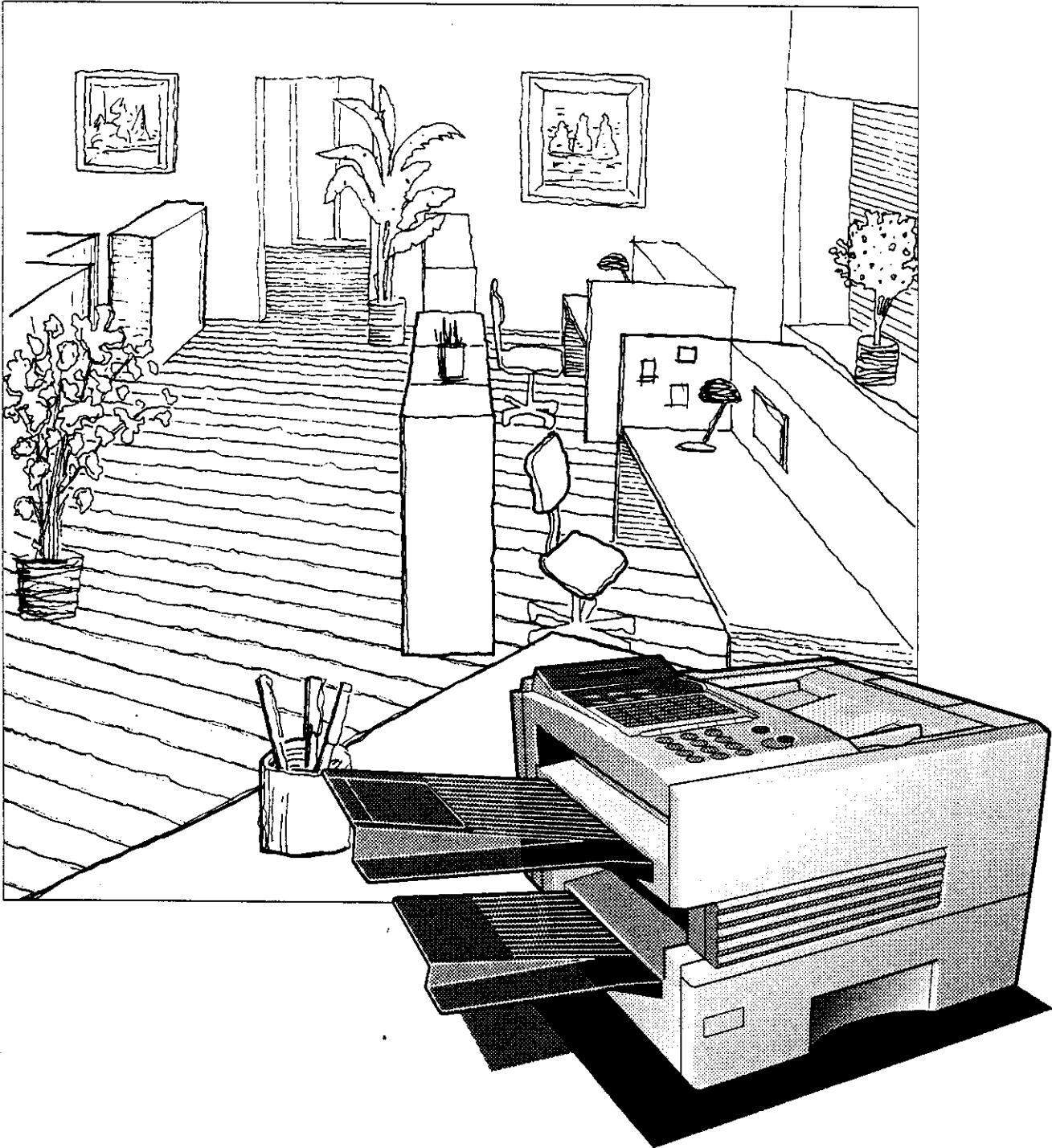

0
0
0

0
0



Table of Contents

1 GETTING TO KNOW YOUR MACHINE

Safety Information	6
Introduction.....	9
Function Key	10
External View	11
Control Panel	12

2 INSTALLING YOUR MACHINE

Main Unit and Accessories	14
Installing the Accessories	15
Installing the Toner Cartridge	16
Loading the Recording Paper	18
Paper Specifications	18
How to Load the Recording Paper	18
Connecting the Telephone Line Cable and Power Cord.....	20
Setting the Dialling Method (Tone or Pulse)	22
Adjusting the Volume.....	23
Setting the Monitor Volume	23
Setting the Ringer Volume	23
User Parameters	24
Setting the Date and Time	24
Setting Your LOGO	25
Setting Your Character ID	26
Setting Your ID Number (Fax Telephone Number)	27

3 PROGRAMMING YOUR MACHINE

One-Touch/Abbreviated Dialling Numbers	29
Entering One-Touch/Abbreviated Dialling Numbers	29
Changing or Erasing One-Touch/Abbreviated Dialling Numbers	31
Printing Out a Directory Sheet	33
Customizing Your Machine	34
Setting the Fax Parameters	34
Fax Parameter Table	35

4 BASIC OPERATIONS

Loading Documents	39
Documents You Can Send	39
Documents You Cannot Send	39
How to Load Documents	40
Basic Transmission Settings	41
Contrast	41
Resolution	41
Halftone	42
Verification Stamp	42
Communication Journal (COMM. JOURNAL)	43

Sending Documents	44
Memory Transmission	44
Manual Number Dialling	46
One-Touch Dialling	47
Abbreviated Dialling	48
Directory Search Dialling	49
Multi-Station Transmission (Broadcasting)	50
Direct Transmission	51
Manual Number Dialling (Direct Transmission)	51
One-Touch Dialling (Direct Transmission)	52
Abbreviated Dialling (Direct Transmission)	53
Directory Search Dialling (Direct Transmission)	54
Voice Mode Transmission	55
Off-Hook Dialling	55
On-Hook Dialling	56
Transmission Reservation	57
Memory Transmission Reservation (Multi-tasking)	57
Direct Transmission Reservation (Priority Transmission Reservation)	58
Redialling	59
Automatic Redialling	59
Manual Redialling	59
Receiving Documents	60
Automatic Reception	60
Manual Reception	60
Print Reduction	61
Selecting the Print Reduction Mode	61
Receiving Oversize Documents	62
Substitute Memory Reception	63
Print Collation Mode	63
Making Copies	64

5 ADVANCED FEATURES

Batch Transmission	65
Real-time Batch Transmission	65
Delayed Batch Transmission	65
Timer Controlled Communications	66
Deferred Transmission	66
Deferred Polling	67
Polling	68
Setting the Polling Password	68
Preparing to be Polled	69
To Poll Documents from Another Station	70
Program Keys	71
Setting for Group Dialling	71
Setting for Deferred Transmission	72
Setting for Deferred Polling	73
Setting for Normal Polling	74
Setting for One-Touch Key	75
Changing or Erasing the Program Key Settings	76
Edit File Mode	77
Printing a File List	77
Viewing the Contents of a File List	78
Changing the Start Time or the Station of a File	79
Deleting a File	81
Printing Out a File	82
Adding Documents into a File	83
Retry an Incomplete File	84

Access Code	85
Setting the Access Code	85
Operating Your Machine with the Access Code (Restrict all operations)	86
Operating Your Machine with the Access Code (Restrict access of Fax Parameters only)	86
Receive To Memory	87
Setting the RCV To Memory Password	87
Setting RCV To Memory	87
Printing Out Documents	88
Distinctive Ring Detector (DRD)	89
Fax Cover Sheet	90
General Description	90
To use the Fax Cover Sheet	90
Fax Forward	92
Setting Fax Forward	92
File Transmission	93
Storing the Document(s)	93
Sending the Stored Document(s)	94
Deleting the Stored Document(s)	95
Printing the Stored Document(s)	96
Department Code	97
General Description	97
Setting the Department Code	97
Changing or Erasing the Department Code	99
Sending Document with Department Code	101
Sending Document with Department Code (Voice Mode Transmission)	102
Printing a Department Code List	103
Printing a Department Code Journal	104
Multiple LOGO	106
General Description	106
Setting the Multiple LOGO	106
Changing or Erasing the Multiple LOGO	107
Sending Document with Multiple LOGO	108
Printing a Multiple Logo List	109

6 NETWORK FEATURE

Selective Reception	111
Setting the Selective Reception	111
Password Communications	112
General Description	112
Compatibility with Other Machines	112
Setting Password Transmission	113
Setting Password Reception	114
Using Password Transmission	115
Using Password Reception	116

Confidential Mailbox and Confidential Network Communications.....	117
Confidential Mailbox	117
Compatibility with Other Machines	117
Sending a Confidential Document to a Remote Station's Mailbox	118
Polling a Confidential Document from a Remote Station's Mailbox	119
Receiving a Confidential Document to Your Machine's Mailbox	120
Storing a Confidential Document in Your Machine's Mailbox	121
Printing Out a Confidential Document from Your Machine's Mailbox	122
Deleting a Confidential Document Stored in Your Machine's Mailbox	123
Confidential Network Communications (Via a Center Station)	124
Compatibility with Other Machines	125
Setting Up Your Machine for Confidential Network Communications	125
Relayed Transmission	128
General Description	128
Compatibility with Other Machines	128
Relay Network	129
Setting Up Your Machine for Relayed Transmission	131
Sending a Document by Relayed Transmission	135
Printouts and Reports	136
Sub-addressing	138
General Description	138
To set the Sub-address into a One-Touch/ABBR. Dialing Numbers	139
To send a Document with Sub-address	140

7 PRINTOUT JOURNALS AND LISTS

Journals and Lists	141
Transaction Journal	141
Individual Transmission Journal (IND. XMT JOURNAL)	142
Communication Journal (COMM. JOURNAL)	145
One-Touch/Abbreviated and Directory Search List	147
Program List	150
FAX Parameter List	151

8 PROBLEM SOLVING

Troubleshooting.....	153
If You Have Any of These Problems	153
Information Codes	155
Clearing a Recording Paper Jam	158
Clearing a Document Jam	159
Cleaning the Document Scanning Area	160
Cleaning the Printer Roller	161
Adjusting the Automatic Document Feeder (ADF)	162
Verification Stamp	163
Replacing the Lithium Battery	164
Checking the Telephone Line	165

9 APPENDIX

Specifications	167
Recording Paper Specifications	170
Options and Supplies.....	171
Installing the Memory Card (Flash Memory Card and / or DRAM Card)	173
Glossary	174
INDEX.....	179

Safety Information

This product complies with the requirements of EC Council Directives 73/23/EEC amended by 93/68/EEC, and 89/336/EEC amended by 92/31/EEC, 93/68/EEC and 98/13/EEC.

The equipment has been approved in accordance with Council Decision 98/482/EC for pan-European single terminal connection to the public switched telephone network (PSTN). However, due to differences between the individual PSTNs provided in different countries, the approval does not of, of itself, give an unconditional assurance of successful operation on every PSTN network termination point.

In the event of problems, you should contact your equipment supplier in the first instance.

WARNING

denotes a potential hazard that could result in serious injury or death.

- TO PREVENT FIRE OR SHOCK, DO NOT EXPOSE THIS PRODUCT TO RAIN OR ANY TYPE OF MOISTURE.
- TO MINIMIZE THE POSSIBILITY OF SHOCK OR DAMAGE TO THE MACHINE, IT MUST BE PROPERLY GROUNDED.
- THIS PRODUCT CONTAINS HAZARDOUS RADIATION. IF YOU DO NOT FOLLOW THESE INSTRUCTIONS OR USE CONTROLS, MAKE ADJUSTMENTS OR PROCEDURES OTHER THAN THOSE SPECIFIED HEREIN, YOU MAY EXPOSE YOURSELF TO HAZARDOUS RADIATION.
- WHEN YOU OPERATE THIS EQUIPMENT, THE SOCKET-OUTLET SHOULD BE NEAR THE EQUIPMENT AND BE EASILY ACCESSIBLE.
- MAKE SURE THAT THE MACHINE IS INSTALLED IN A SPACIOUS OR WELL-VENTILATED ROOM SO AS NOT TO INCREASE THE AMOUNT OF OZONE IN THE AIR. SINCE OZONE IS HEAVIER THAN AIR, IT IS RECOMMENDED THAT AIR AT FLOOR LEVEL BE VENTILATED.
- PLUG POWER SUPPLY CORD INTO ORDINARY AC OUTLET BEFORE CONNECTING TELEPHONE LINE CORD. DISCONNECT TELEPHONE LINE CORD BEFORE UNPLUGGING POWER SUPPLY CORD FROM AC OUTLET.
- DISCONNECT THE EQUIPMENT IMMEDIATELY SHOULD IT EVER SUFFER PHYSICAL DAMAGE WHICH RESULTS IN THE INTERNAL PARTS BECOMING ACCESSIBLE IN NORMAL USE. IN THIS INSTANCE USERS SHOULD HAVE THE EQUIPMENT REPAIRED OR DISPOSE OF.
- IF THE POWER SUPPLY CORD AND/OR TELEPHONE LINE CORD OF THIS EQUIPMENT ARE DAMAGED, THEY MUST BE REPLACED BY THE SPECIAL CORDS SUPPLIED BY AN AUTHORIZED PANASONIC SERVICE CENTRE.

CAUTION

denotes hazards that could result in minor injury or damage to the machine.

- THIS PRODUCT CONTAINS A LITHIUM BATTERY. DANGER OF EXPLOSION IF BATTERY IS OF USE INCORRECTLY REPLACED.
REPLACE ONLY WITH THE SAME OR EQUIVALENT TYPE. DISPOSE OF USED BATTERIES ACCORDING TO THE INSTRUCTIONS OF YOUR LOCAL SOLID WASTE OFFICIALS.

1 When you know that a thunderstorm is coming, we recommend that you:

- (1) Unplug the telephone line cord from the phone jack.
- (2) Turn off the power and unplug the power supply cord from AC outlet.

2 This equipment may not necessarily provide for the effective hand-over of a call to or from a telephone connected to the same line.

3 The operation of this equipment on the same line as telephones or other equipment with audible warning devices or automatic ring detectors will give rise to bell tinkle or noise and may cause false tripping of the ring detector. Should such problem occur, the user is not to contact telecom (telephone company) faults service.

For New Zealand Users

The grant of a Telepermit for any item of terminal equipment indicates only that Telecom has accepted that the item complies with minimum conditions for connection to its network. It indicates no endorsement of the product by Telecom, nor does it provide any sort of warranty. Above all, it provides no assurance that any item will work correctly in all respects with another item of Telepermitted equipment of a different make or model, nor does it imply that any product is compatible with all of Telecom's network services.

This equipment is not capable, under all operating conditions, of correct operation at the higher speeds for which it is designed. Telecom will accept no responsibility should difficulties arise in such circumstances.

IMPORTANT NOTICE

Under power failure conditions, this telephone may not operate. Please ensure that a separate telephone, not dependent on local power, is available for emergency use in emergencies.

This equipment should not be used under any circumstances which may constitute a nuisance to other Telecom customers.

This equipment shall not be set to make automatic calls to the Telecom '111' Emergency Service.

Not all telephones will respond to incoming ringing when connected to the extension socket.

Manufacturer's Network Compatibility Declaration to the user

The products, Model UF-885/895-** (** means country suffixes as table below.), are designed to comply with the requirements, *TBR21:1998 and EG201121 (V1.1.2): 1998*, and are designed to work with the Analogue Public Switched Telephone Networks under the scope of above requirements.

If it is desired to use the equipment on another network, please contact the vendor.

**	Country	**	Country	**	Country	**	Country
AA	Austria	AJ	Spain	AQ	Ireland	EE	Italy
AD	Denmark	AM	Switzerland	AR	Belgium	YG	Greece
AF	Finland	AN	Norway	AS	Sweden		
AH	The Netherlands	AP	Portugal	AV	France		

▶ Safety Information

⚠ CAUTION

denotes hazards that could result in minor injury or damage to the machine.

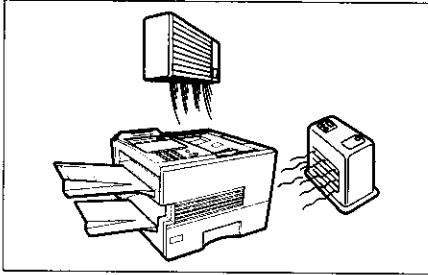

Do not install the machine near heating or an air conditioning unit.

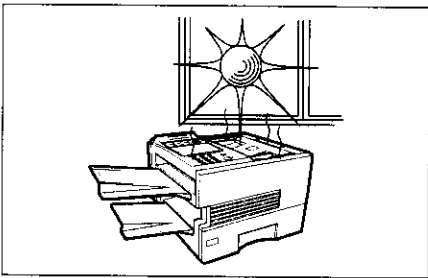

Avoid exposure to direct sunlight.

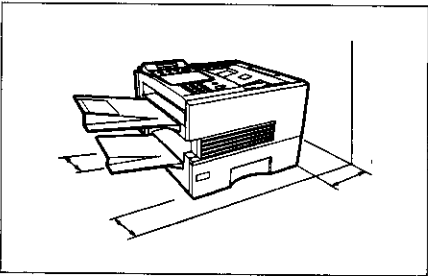

Install the machine on a flat surface, leave at least 10 cm of space between the machine and other objects.

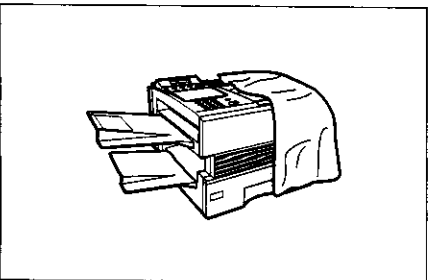

Do not block the ventilation openings.

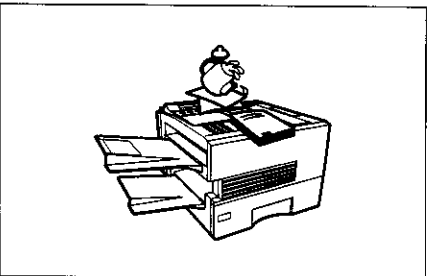

Do not place heavy objects or spill liquids on the machine.

Thank you very much for purchasing the Panafax **UF-885/895**.

The **UF-885/895** is one of the most advanced models in the Panafax family of G3 compatible, desktop facsimile machines.

Some of its many features are

- 1. Plain Paper Printing** Plain paper printing means you can easily write on received documents with a pen or pencil. Documents do not curl, making filing easier. In addition, plain paper does not fade, making it ideal for long term storage of important documents.
- 2. Quick Scanning** The **UF-885/895** Quick Scan speeds up the fax process by scanning and storing documents into memory in about 1* second per page.
(UF-885 : 2.8 seconds)*
(Standard Resolution, Based on ITU-T Image No.1 Test Chart, Scanning speed applies to the feeding process from the leading to the lagging edge of a single page test chart. Time for storing process is not applied for this definition.)*
This means that you no longer have to wait around until a transmission is completed before retrieving your originals.
- 3. Quick Memory Transmission** Unlike conventional memory-based fax machines, the **UF-885/895** dials as soon as the first page has been scanned. You can continue to scan additional pages while transmission is taking place. With simultaneous scanning and sending, you will save even more time.
- 4. Batch Transmission** The **UF-885/895** permits accumulation of different documents for the same destination(s) to be transmitted in a single phone call.
- 5. Easy Maintenance** Maintenance requires only changing a toner cartridge, making it quicker and easier than with other types of plain paper fax machines.
- 6. Memory Function** A standard image memory feature allows you to store up to 120* standard pages into the document memory. After the **UF-885/895** stores your documents, it can send them to selected station(s) automatically.
You do not have to wait until the transmission ends before retrieving your originals. *(*UF-885 : 60 standard pages)*
- 7. Multi- Access Operation** The **UF-885/895** allows you to reserve the next transmission even during reception or memory transmission. It can also receive during document storage.
- 8. Multiple LOGO** The **UF-885/895** allows you to select from Multiple LOGOs which are printed on the Header of each page sent, Cover Sheet, COMM. Journal and Individual XMT Journal.
- 9. Department Code** This feature allows multiple departments to share the same facsimile machine. When a department code is assigned to each department, the Transaction Journal will be sorted by each department number.
- 10. View Mode** Your machine has been equipped with a View function which allows you to view the contents of the Journal and File List on the LCD display without having to print them.

With a little practice, anyone can learn how to use the most popular features of the **UF-885/895**.

This User's Guide will help you to use your **UF-885/895** quickly and easily. The Table of Contents shows where to find information on each feature. Although we recommend that you review each section briefly, it will only be necessary to read the sections that contain the feature(s) you will be using.

Function Key

Any function can be started by first pressing **FUNCTION** and then enter the function number, or by pressing **▼** or **▲** scroll key repeatedly until the desired function appears on the display.

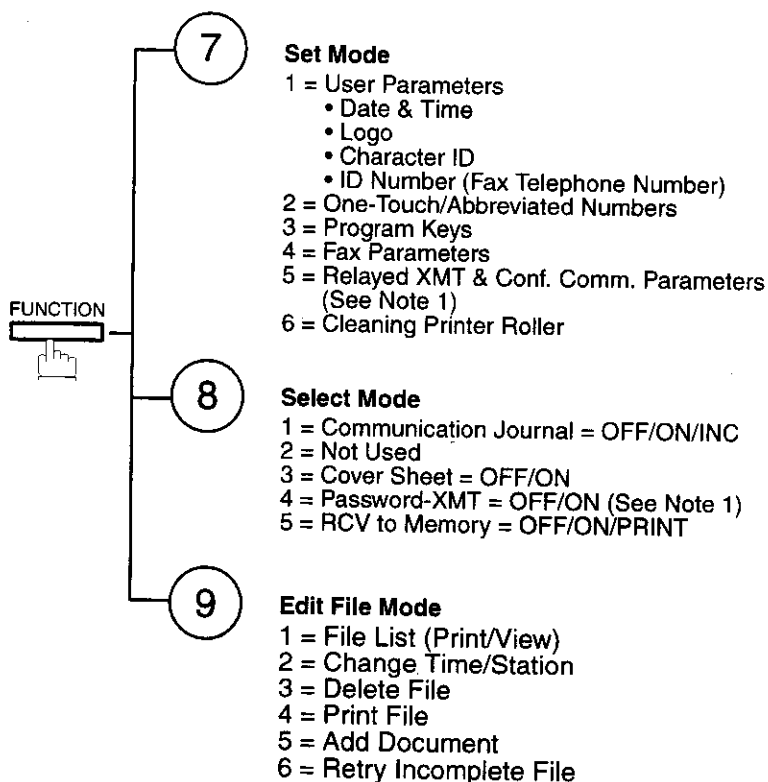
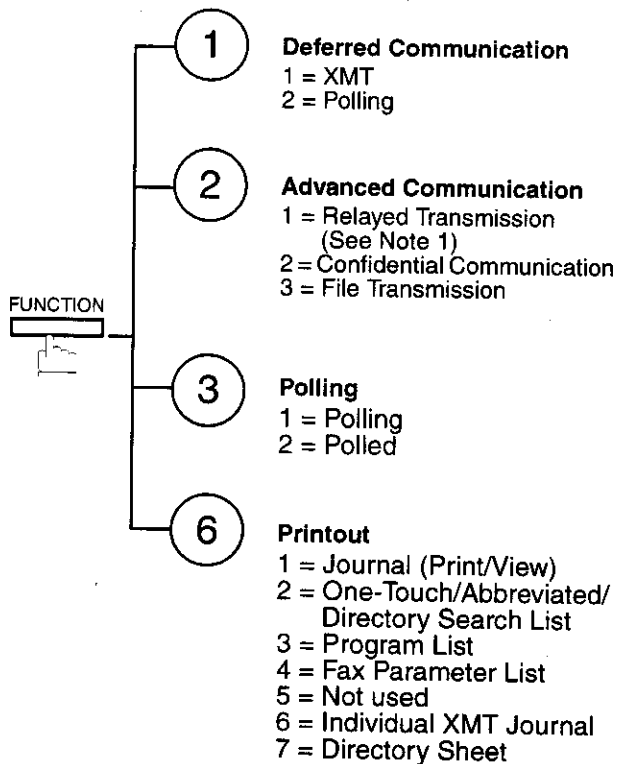

! **Note:**
1. If Fax Parameter is not preset to a Valid position, which enables you to use the function, the display will not show the function.

External View

1
=

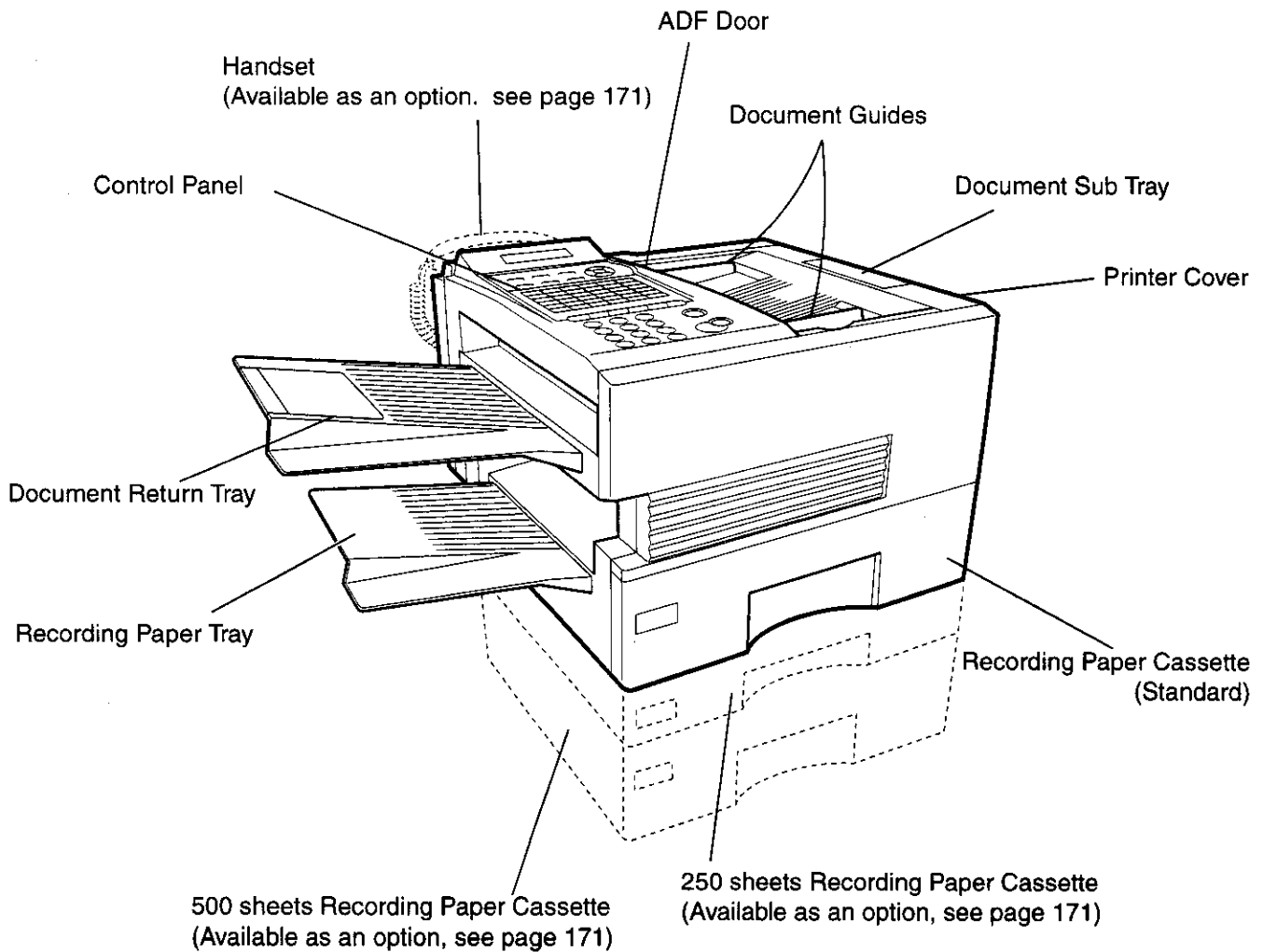

Note:

1. For some countries, the handset may not be available because of the country's regulation or specification.

Control Panel

LCD Display

Indicates date and time, or the current operation.

- ON LINE Blinks when the machine is transmitting a document or receiving.
- TONER Blinks when the remaining toner is getting low and lights when the toner is running out. (See page 16)
- ALARM Lights when trouble occurs. (See page 153)

One-Touch Keys (01-32)

Used for One-Touch Dialing. (See page 47 and 52)

Program Keys (P1-P8)

Used to record long dialing procedures or Group Dialing Number keys. (See page 71 to 76)

Character Keys

The One-Touch Keys and Program Keys also serve as character and symbol input keys which are used to record your LOGO, character ID and station name. The character key template is printed on the panel under the directory sheet cover.

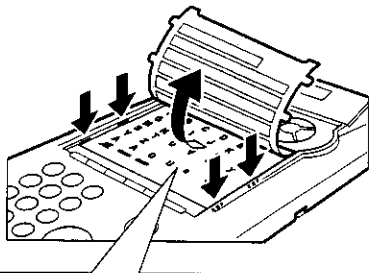



01	A	02	B	03	C	04	D	05	E	06	F
07	G	08	H	09	I	10	J	11	K	12	L
13	M	14	N	15	O	16	P	17	Q	18	R
19	S	20	T	21	U	22	V	23	W	24	X
25	Y	26	Z	27		28		29		30	
31	À	32	Á	P1	Ö	P2	Û	P3		P4	
P5	Æ	P6	SPACE	P7	SYMBOLS	P8	CAPS	LINE SELECT	MONITOR		

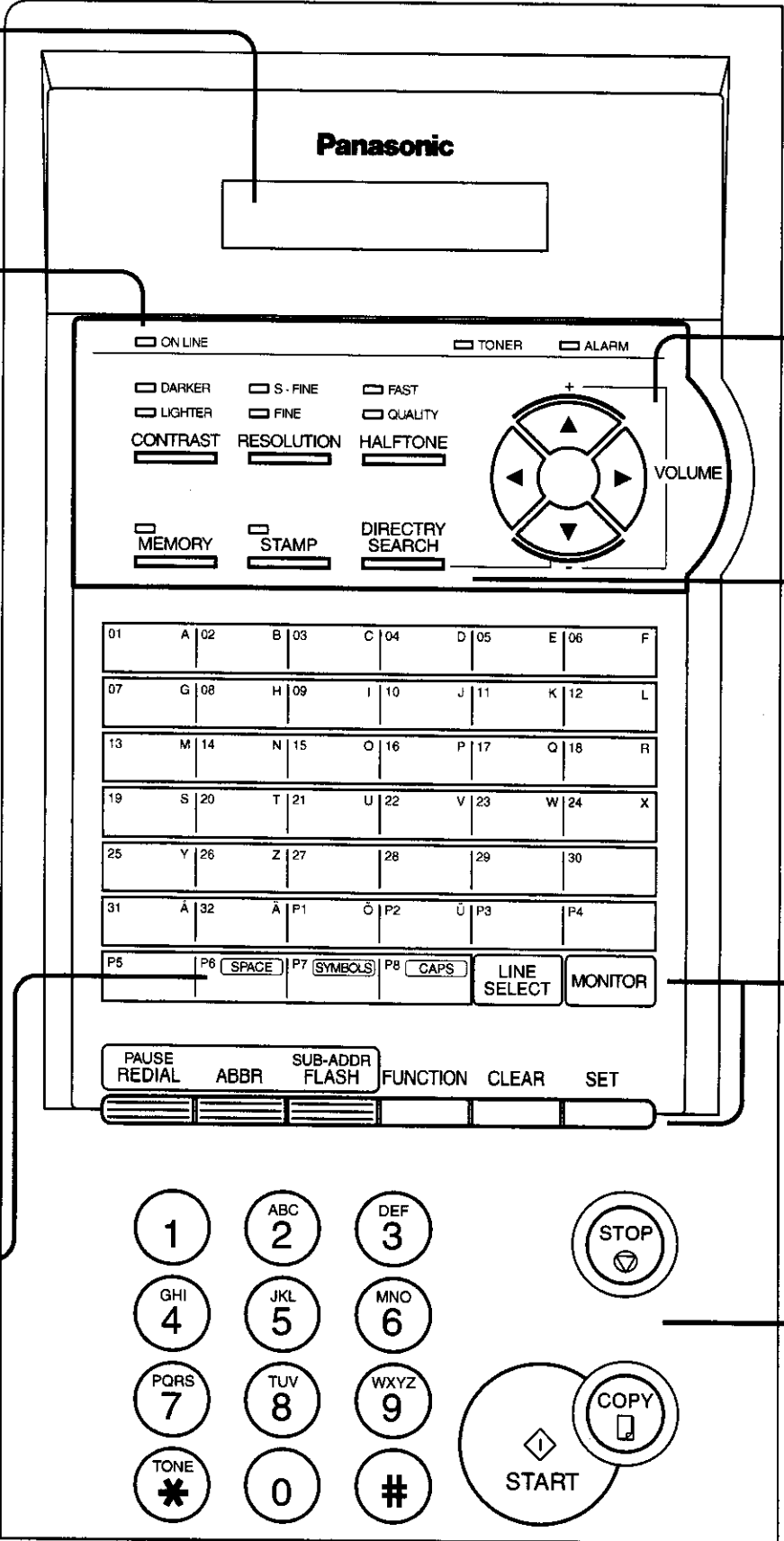

- SPACE Used to insert a space while entering LOGO, character ID and station name.
- SYMBOLS Used to enter a symbol (, ' & () ; : + - . /) for LOGO, character ID and station name. Use ▼ or ▲ to select the symbols.
- CAPS Used to switch between upper and lower character set.



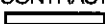
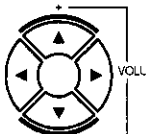

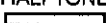







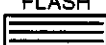

Control Panel

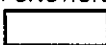
1

CONTRAST 	Used to set Normal, Lighter, or Darker. (See page 41)		Used for the following: <ul style="list-style-type: none"> • Adjust the monitor and ringer volume. (See page 23) • Move the cursor while entering numbers and characters. • Search the station name for Directory Search Dialing. • Confirm the entered station for multi-station communication. • Select functions. • Confirm the current communication modes (e.g. Page number, ID, Dialed Telephone number, File number) when the unit is ON LINE.
RESOLUTION 	Used to set Standard, Fine, Super-Fine. (See page 41)		
HALFTONE 	Provides OFF, QUALITY or FAST settings for halftone documents. (See page 42)		

MEMORY 	Used to select either memory or direct communication. (See page 44 to 54)	STAMP 	Used to turn the verification stamp ON or OFF. (See page 42)
		DIRECTRY SEARCH 	Used to search for a station name. (See page 49 and 54)

PAUSE REDIAL 	Used to enter a pause when recording or dialing a telephone number, or to redial the last dialed number. (See page 59)	CLEAR 	Used to erase the previously entered input.
ABBR 	Used to start Abbreviated Dialling. (See page 48 and 53)	SET 	Used to set operations.
SUB-ADDR FLASH 	Used to separate the Sub-address from the telephone number when dialling, or to access some features of your PBX.	LINE SELECT 	Used to select the communication port. Available for UF-895 only if the Optional G3 Communication Port Kit has been installed. (See page 171)
FUNCTION 	Used to start or select the function and sub-functions. These functions are explained in detail on page 10.	MONITOR 	Used to start On-Hook Dialling. (See page 56)

	Used for Manual Number Dialling, recording phone numbers, and selecting functions.		Used to cancel operations. When it is pressed, the machine will return to standby.
			Used to make copies. (See page 64)
	Used to temporarily change the Dialling Mode to Tone when Pulse mode is set.		Used to start operations.

► Main Unit and Accessories

Unpack the carton and check that you have all the accessories illustrated.

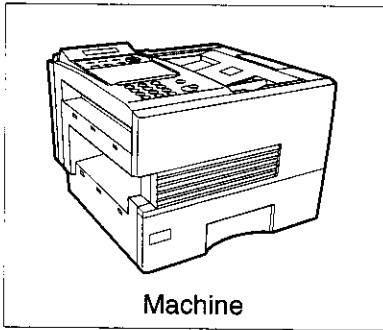

Machine

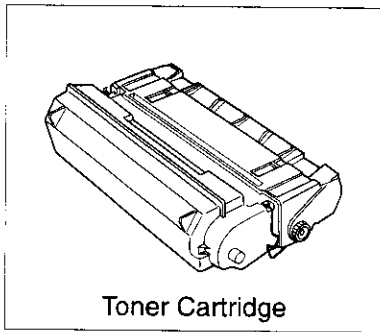

Toner Cartridge

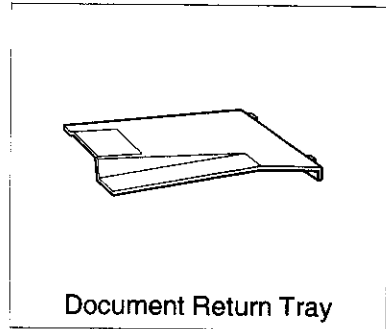

Document Return Tray

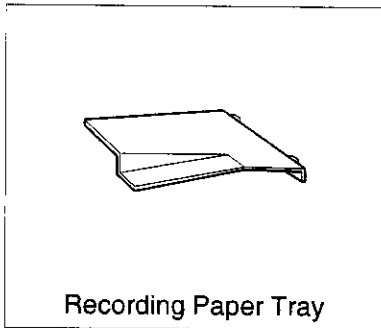

Recording Paper Tray

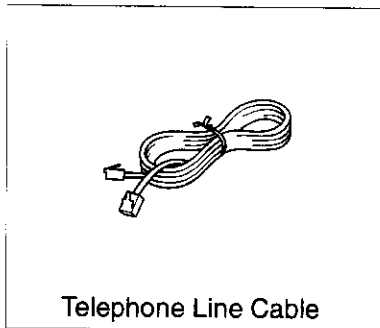

Telephone Line Cable

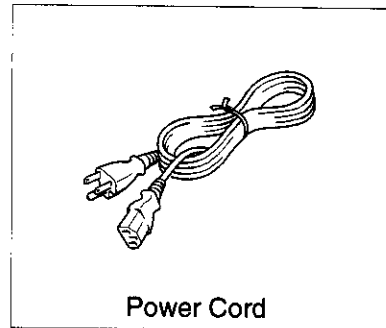

Power Cord

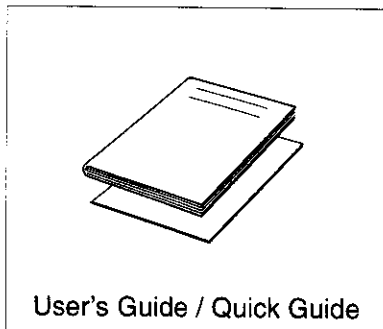

User's Guide / Quick Guide

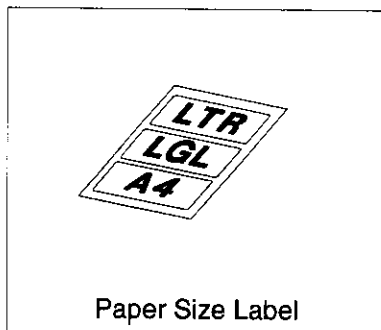

Paper Size Label

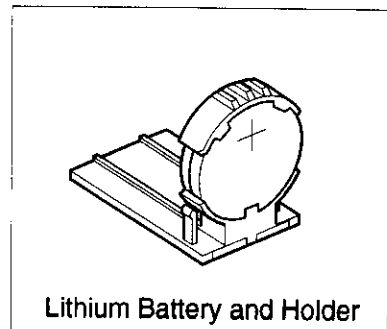

Lithium Battery and Holder

Installing the Accessories ◀

2

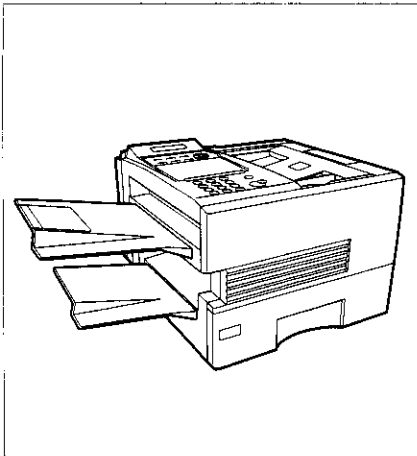

Final Installed View

Installing the Lithium Battery

(This battery is used to backup the clock during power failures, see page 164)

- (1) Open the ADF Door.
- (2) Install the Battery Holder, slide it to the Left until it latches and close the ADF Door.

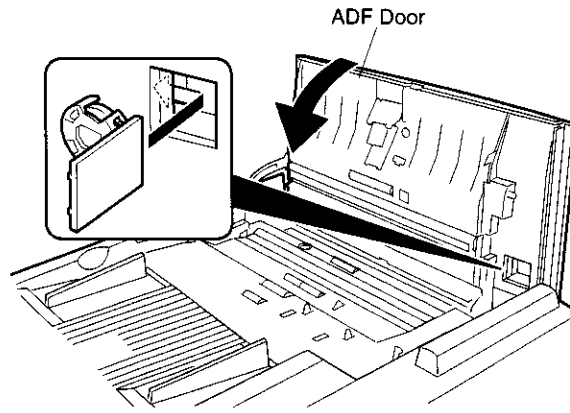

Handset Cradle [Available as an Option]

Hook the projections into the square holes on the machine.
Connect the cable into the HANDSET jack on the machine.

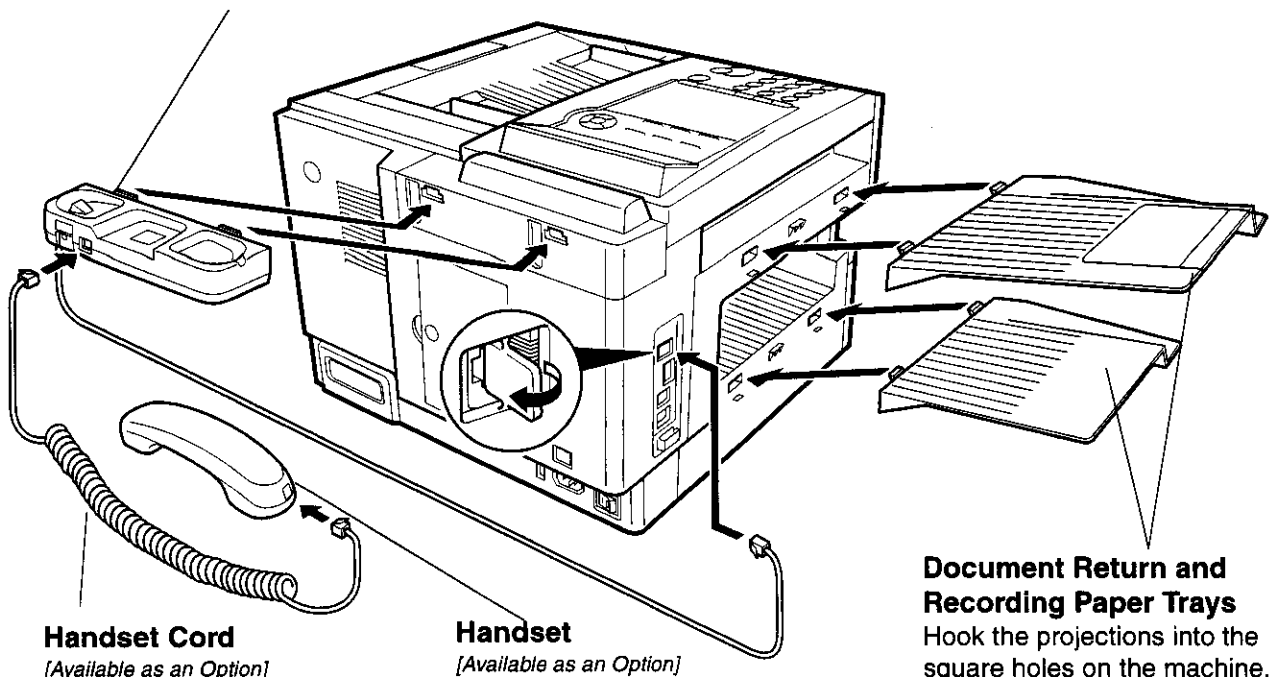

Handset Cord
[Available as an Option]

Handset
[Available as an Option]

Document Return and Recording Paper Trays
Hook the projections into the square holes on the machine.



Note:

1. For some countries, the handset may not be available because of the country's regulation or specification.

▶ Installing the Toner Cartridge

1

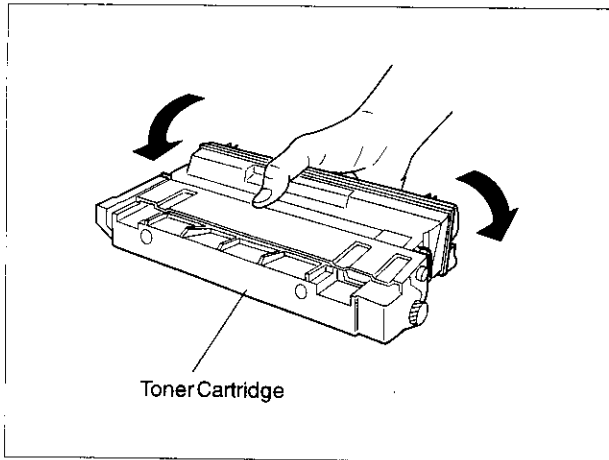

Unpack the Toner Cartridge and rock it back and forth as shown for 5 or 6 times to even the toner inside.

2

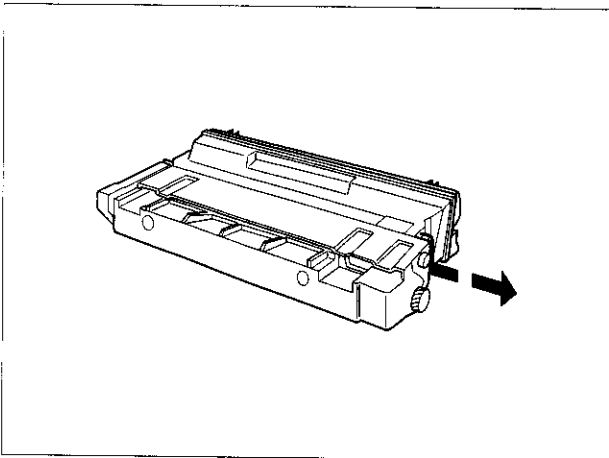

Remove the protective seal.

3

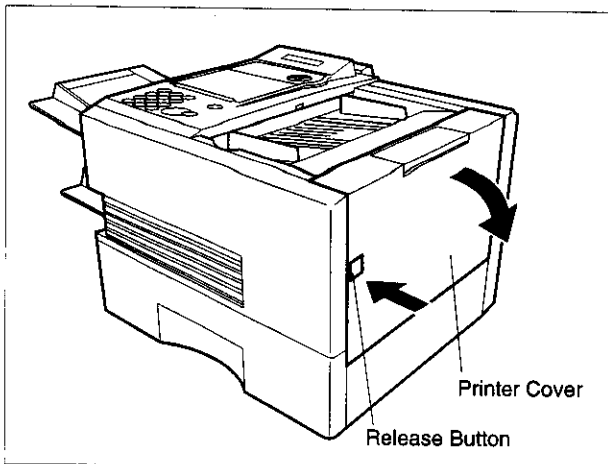

Push the Release Button to open the Printer Cover.

Continued on the next page.

Installing the Toner Cartridge

4

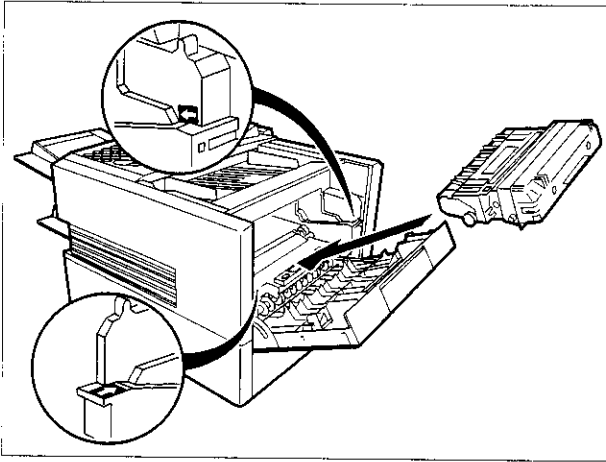

Align the arrow and the projection on both sides as shown and insert the Toner Cartridge into the machine.

2

5

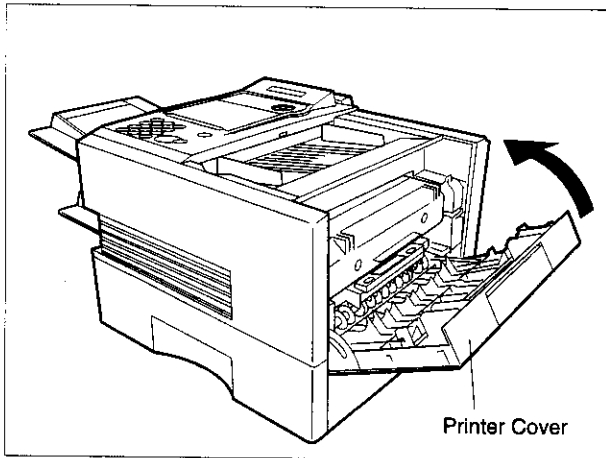

Close the Printer Cover firmly.

6 If you are replacing the Toner Cartridge, it is recommended to clean the Printer Roller to maintain good printing quality. To clean the Printer Roller, follow the procedure on page 161.

▶ Loading the Recording Paper

Paper Specifications

In general, most bond papers will produce excellent results. Most photocopy papers will also work very well. There are many "name" and "generic" brands of paper available. We recommend that you test various papers until you obtain the results you are looking for. For detailed recommended paper specifications, see page 170.

How to Load the Recording Paper

1

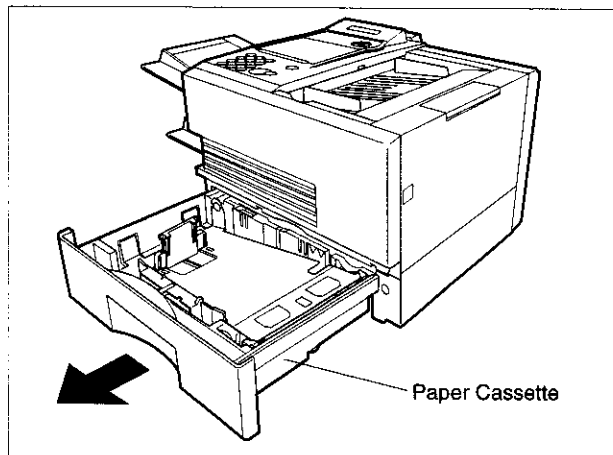

Slide out the Paper Cassette from the machine.

2

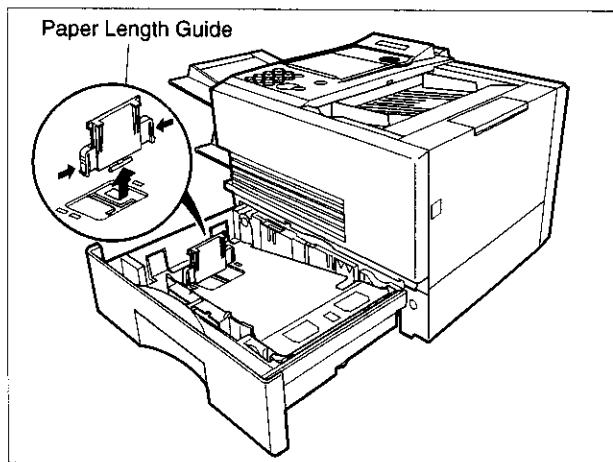

Adjust the Paper Length Guide to the proper paper size (A4, LTR, or LGL).

For LGL size paper, remove the Paper Length Guide and store it in the provided slot in the front left side of the Paper Cassette.

If reloading the same size of paper, skip the step 2 and 3.

3

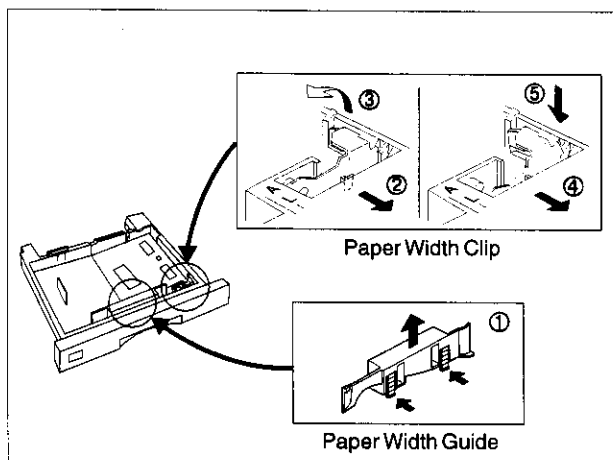

Adjust the Paper Width Guide and Clip to the proper paper (A4, or LTR/LGL).

The factory default for the Paper Width Guide and Clip are on A4 position. For LTR/LGL paper size, adjust by following the steps below.

- (1) Replace the Paper Width Guide into the proper slot (A4 or LTR/LGL).
- (2) Release the Paper Width Clip latch.
- (3) Pull upwards to remove the Paper Width Clip.
- (4) Replace the Paper Width Clip into the A(A4) or L(LTR/LGL) slot.
- (5) Push down on the Paper Width Clip to latch it in place.

Loading the Recording Paper

2

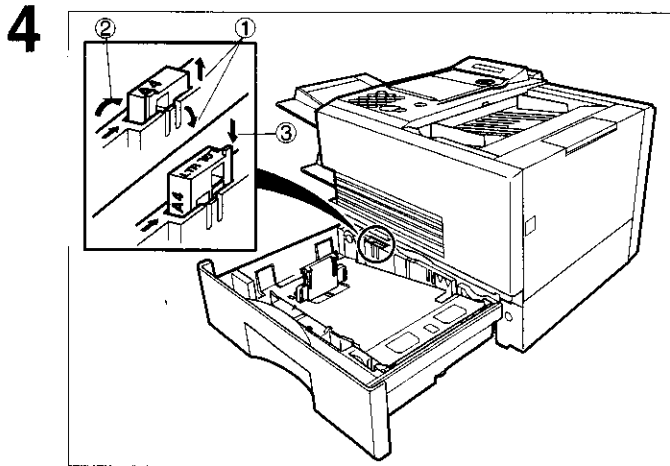

- (1) Release the hook and remove the Paper Size Selector.
- (2) Rotate the Paper Size Selector until the appropriate setting marked on the Selector is facing upward and the wording is upright.
- (3) Reinstall the Paper Size Selector.

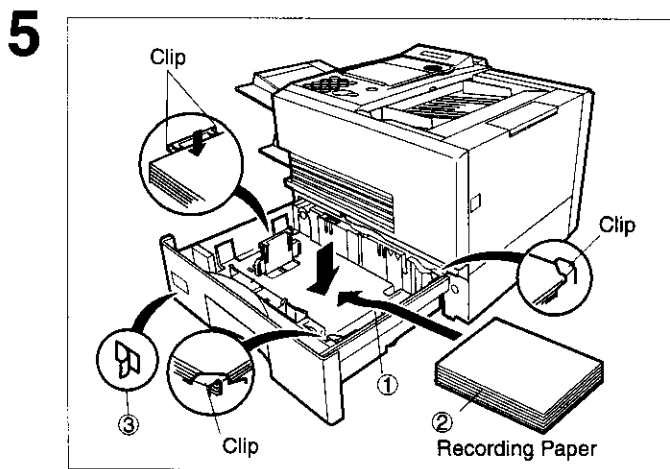

- (1) Push the Pressure Plate until it is locked down.
- (2) Load the paper into the Paper Cassette.

Caution: Make sure that the paper is set under the clips of the Paper Cassette. You can load about 500 sheets with standard weight paper (20 lb. or 75 g/m²). For paper specification see page 170.

- (3) Set the proper paper size label.

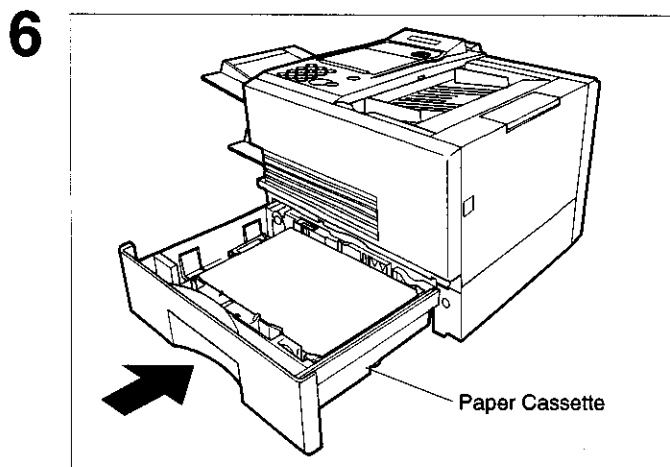

Slide the Paper Cassette into the machine.

! **Note:**

1. Your machine will properly print on A4, Letter and Legal size paper only. If other size of paper (B4, B5, A5) is used, your machine may not print properly.

▶ Connecting the Telephone Line Cable and Power Cord

■ Power Cord

Plug one end of the power cord into an ordinary AC outlet and the other end into the receptacle on the back of the machine.

Warning : This apparatus must be properly earth grounded through an ordinary AC outlet.

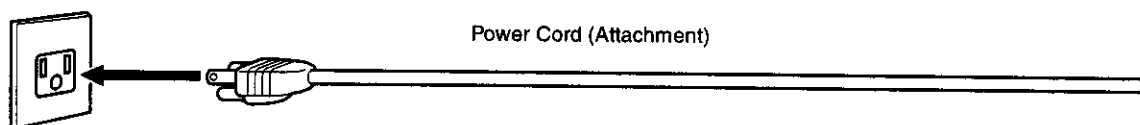

■ Telephone Line Cable

Plug one end of the telephone line cable into the telephone jack supplied by the telephone company and the other end into the LINE jack on the left side of the machine.

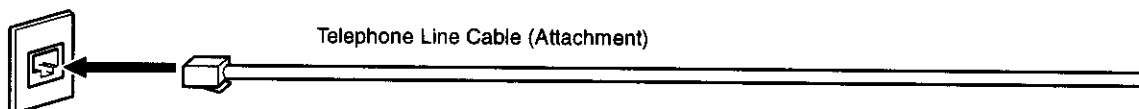

! Note:

1. Your machine uses little power and you should keep it ON at all times.

Connecting the Telephone Line Cable and Power Cord

2

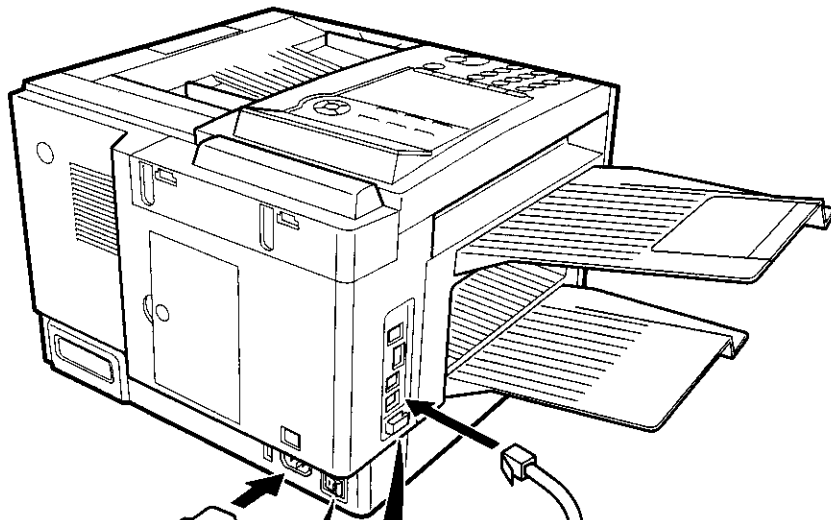

■ **Power Switch**

After connecting all cables and Power Cord, turn the power switch ON.



Note

Attach the cable to the Hook to prevent recording paper jam.

▶ Setting the Dialling Method (Tone or Pulse)

Your machine can operate with either of two dialling methods (Tone or Pulse), depending on the type of telephone line you are connected to. If you need to change the dialling method to Tone or Pulse, follow the procedure below.

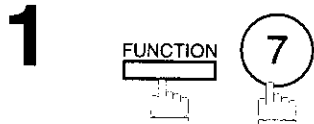

```
SET MODE      (1-6)
ENTER NO. OR v ^
```

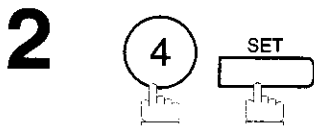

```
FAX PARAMETER(01-99)
NO.=■
```

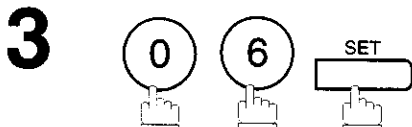

```
06 DIALLING METHOD
2:TONE
```

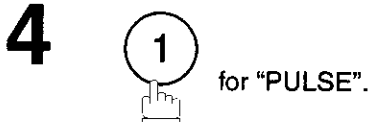

```
06 DIALLING METHOD
1:PULSE
```

or

or

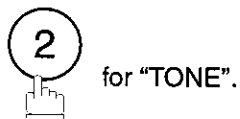

```
06 DIALLING METHOD
2:TONE
```

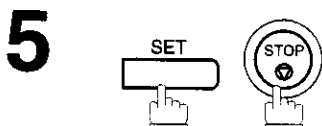

Note:

1. For some countries, this feature is not available depending on the country's regulation. The display may not show this feature.

Adjusting the Volume

You can adjust the monitor and ringer volume on your machine. The built-in speaker enables you to hear the dial tone, dialling signals, and busy tone. The ringer sounds when your machine receives a call.

2

Setting the Monitor Volume

1

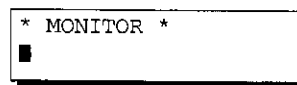

You will hear the dial tone through the speaker.

2

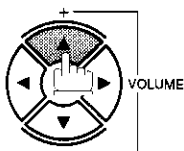

repeatedly to raise the volume.

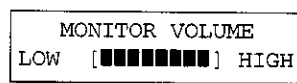

or

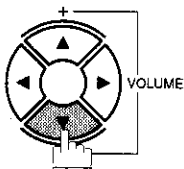

repeatedly to lower the volume.

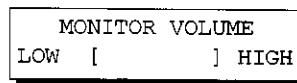

3



Setting the Ringer Volume

1

Standby

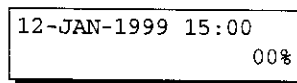

2

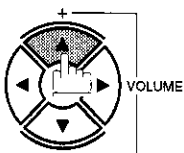

repeatedly to raise the volume.



or

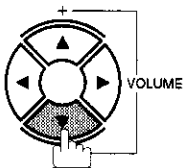

repeatedly to lower the volume.

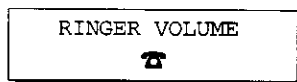

3



! Note:

1. You can also adjust the volume of the key touch tone and the volume of the buzzer in the Fax Parameter No. 10 (KEY/BUZZER VOLUME). (See page 35)

► User Parameters

Your facsimile machine has several basic settings (User Parameters) to help you keep records of the documents you send or receive. For example, the built-in clock keeps the current date and time, and your LOGO and ID Number help to identify you when you send or receive documents.

Setting the Date and Time

At standby the display will show the date and time. Once the standby display is set, it will automatically be updated.

1

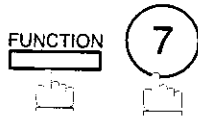

SET MODE (1-6)
ENTER NO. OR V ^

2



1:USER PARAMETERS?
PRESS SET TO SELECT

3

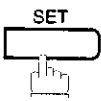

DATE & TIME
■1-01-1999 00:00

4

Enter the new date and time.

Ex: ①② Date : 12th
 ①① Month : January
 ①⑨⑨⑨ Year : 1999
 ①⑤①① Time : 3:00 PM

DATE & TIME
12-01-1999 15:00

If you make a mistake, use ◀ or ▶ to move the cursor over the incorrect number, then overwrite it with a correct one.

5

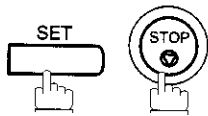

User Parameters

Setting Your LOGO

When you send a document, your LOGO appears on the top of the copy printed out at the other station.

The LOGO helps to identify you to someone who receives your document.

2

1

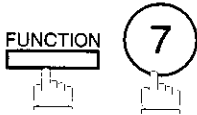

SET MODE (1-6)
ENTER NO. OR v ^

2



1:USER PARAMETERS?
PRESS SET TO SELECT

3

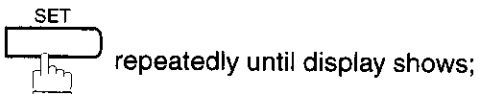

LOGO
█

4

Enter your LOGO (max. 25 characters and digits) by using the Character keys (See page 12).

Ex: P A N A S O N I C

If you make a mistake, use ◀ or ▶ to move the cursor beyond the incorrect character, press CLEAR then re-enter the new character.

If more than 19 characters are entered, the left side characters will scroll off the display.

LOGO
PANASONIC█

5

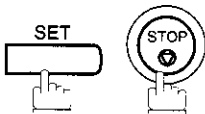

▶ User Parameters

Setting Your Character ID

If the remote machine has a Character ID capabilities, when you are sending or receiving, your Character ID will appear on the remote machine's display and the remote machine's Character ID will appear on your display.

1

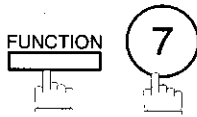

```
SET MODE      (1-6)
ENTER NO. OR ∨ ^
```

2

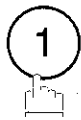

```
1:USER PARAMETERS?
PRESS SET TO SELECT
```

3

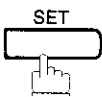

repeatedly until display shows;

```
CHARACTER ID
█
```

4

Enter your Character ID (max. 16 characters and digits) by using the Character keys (See page 12).

Ex: **H E A D SPACE O F F I C E**

If you make a mistake, use ◀ or ▶ to move the cursor beyond the incorrect character, press **CLEAR** then re-enter the new character.

```
CHARACTER ID
HEAD OFFICE█
```

5

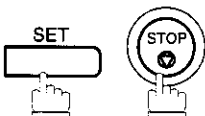

! Note:

1. The special characters of Å, Ä, Ö, Ü, Æ, è and é cannot be used for Character ID.

User Parameters

Setting Your ID Number (Fax Telephone Number)

If the remote machine does not have a Character ID but it has an ID Number, when sending or receiving, your ID Number will appear on the remote machine's display and their ID Number will appear on your display.

2

We suggest you use your facsimile telephone number as your ID number. (max. 20 digits)

1

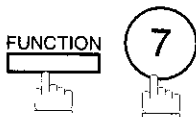

SET MODE (1-6)
ENTER NO. OR V ^

2



1:USER PARAMETERS?
PRESS SET TO SELECT

3



repeatedly until display shows;

ID NO.
■

4

Enter your ID (max. 20 digits) by using the key pad and **SPACE**.

Ex: (2) (0) (1) **SPACE** (5) (5) (5)
SPACE (1) (2) (1) (2)

ID NO.
201 555 1212■

If you make a mistake, use **◀** or **▶** to move the cursor beyond the incorrect number, press **CLEAR** then re-enter the new number.

5

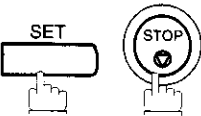

! Note:

- You may use ***** to enter a "+" character at the beginning of the ID number to indicate the following digit(s) for your country code.
Ex: +1 201 555 1212 +1 for U.S.A. country code.
+81 3 111 2345 +81 for Japan country code.
- For some countries, this feature is not available depending on the country's regulation. The display may not show this feature.

This page is intentionally left blank.

One-Touch/Abbreviated Dialling Numbers

Entering One-Touch/Abbreviated Dialling Numbers

One-Touch and Abbreviated Dialling are two fast ways of dialling full telephone numbers. To use these dialling methods, you must first store the telephone number using the following procedure.

To enter a One-Touch key, follow the steps below

1

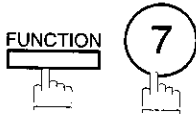

SET MODE (1-6)
ENTER NO. OR √ ^

2

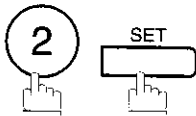

1: ONE-TOUCH
2: ABBR NO.

3



ONE-TOUCH< >
PRESS ONE-TCH OR √ ^

4

Ex: 01

<01>
ENTER TEL. NO.

5

Enter the telephone number
(up to 36 digits including pauses and spaces).

Ex: 9 PAUSE 5 5 5 SPACE 1 2 3 4

<01>
9-555 1234

6

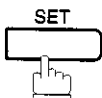

<01> ENTER NAME
9-555 1234

7

Enter the station name using character keys
(up to 15 characters).

Ex: S A L E S SPACE D E P T

<01> SALES DEPT
9-555 1234

8

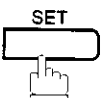

ONE-TOUCH< >
PRESS ONE-TCH OR √ ^

To record another number, repeat step 4 to 8.

To return to standby, press **STOP**.

3

▶ One-Touch/Abbreviated Dialling Numbers

To set an Abbreviated Dialling Number, follow the steps below

1  

SET MODE (1-6)
 ENTER NO. OR ∨ ^

2  

1: ONE-TOUCH
 2: ABBR NO.











3 

ABBR. [■]
 ENTER NO. OR ∨ ^

4 Ex:    (001 to 160)

[022]
 ENTER TEL. NO.

5 Enter the telephone number
(up to 36 digits including pauses and spaces).











Ex:          

[022]
 9-555 2345■

6 

[022]ENTER NAME
 9-555 2345

7 Enter the station name using character keys
(up to 15 characters).

Ex:          





[022]ACCOUNTING■
 9-555 2345

8 

ABBR. [■]
 ENTER NO. OR ∨ ^

To record another number, repeat step 4 to 8.
 To return to standby, press .

! Note:

1. If you require a special access number to get an outside line, enter it first and then press .
A hyphen "-" is displayed for pause.
2. Use  to enter a space between the numbers to make it easier to read.
3. If you are using Pulse dialling and you wish to change to Tone dialling in the middle of dialing, press  (represented by a"/"). The dialling method will be changed from Pulse to Tone after dialling the digit "/".
Ex: 9 PAUSE TONE 5551234
4. You can search for an unused One-Touch key or ABBR. number by pressing  or  in step 3 or 4.

One-Touch/Abbreviated Dialling Numbers

Changing or Erasing One-Touch/Abbreviated Dialling Numbers

If you have to change or erase any of the One-Touch/Abbreviated dialling numbers, follow the steps below.

To change the settings of a One-Touch/ABBR. dialling number

1

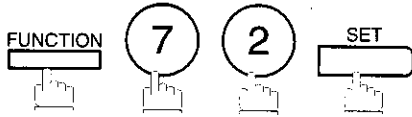

1: ONE-TOUCH
2: ABBR. NO.

2

Select (1) for One-Touch Dialling number
Select (2) for ABBR. Dialling Number

ONE-TOUCH< >
PRESS ONE-TCH OR ∨ ^

Ex: (1)

3

Enter the station you wish to change.

Ex: 01

<01> SALES DEPT
9-555 1234

4



then enter a new telephone number. (See Note 1)

Ex: (9) PAUSE (5) (5) (5) SPACE (3) (4) (5) (6)

<01> SALES DEPT
ENTER TEL. NO.

<01> SALES DEPT
9-555 3456

5



<01> SALES DEPT
9-555 3456

6



then enter a new station name. (See Note 1)

Ex: P A N A F A X

<01> ENTER NAME
9-555 3456

<01> PANAFAX
9-555 3456

7



To return to standby, press STOP.

ONE-TOUCH< >
PRESS ONE-TCH OR ∨ ^

3



Note:

1. If you make a mistake, use ◀ or ▶ to move the cursor beyond the incorrect number, press CLEAR then re-enter the new number.
2. If the One-Touch/Abbreviated dialling number has been used for a communication reservation, the settings cannot be changed or erased until the communication has finished.
To change or erase the settings, cancel the communication first by Edit File Mode. (See page 77)

▶ One-Touch/Abbreviated Dialling Numbers

To erase the settings of One-Touch/ABBR. Dialling number

1

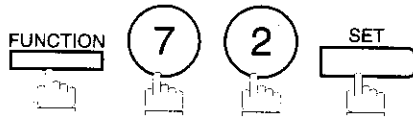

1:ONE-TOUCH
2:ABBR NO.

2

Select ① for One-Touch Dialling number
Select ② for ABBR. Dialling Number

Ex: ①

ONE-TOUCH< >
PRESS ONE-TCH OR ∨ ^

3

Enter the station you wish to erase.

Ex: 01

<01> SALES DEPT
9-555 1234

4



<01> SALES DEPT
ENTER TEL. NO.

5

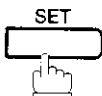

ONE-TOUCH< >
PRESS ONE-TCH OR ∨ ^

To return to standby, press **STOP**.

! Note:

1. If the One-Touch/Abbreviated dialling number has been used for a communication reservation, the settings cannot be changed or erased until the communication has finished.
To change or erase the settings, cancel the communication first by Edit File Mode. (See page 77)

One-Touch/Abbreviated Dialling Numbers

Printing Out a Directory Sheet

After programming a one-touch dialling number, you can print out the directory sheet which includes the first 12 characters of each station name. Cut along the dotted line and place it over the One-Touch key under the Directory Sheet Cover. To print out a directory sheet, follow the steps below.

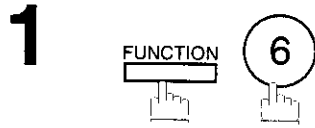

PRINT OUT (1-7)
ENTER NO. OR v ^

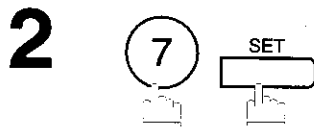

* PRINTING *
DIRECTORY SHEET

Your machine prints out the directory sheet.

3

***** -DIRECTORY SHEET- ***** DATE 12-JAN-1999 ***** TIME 15:00 *****

01	02	03	04	05	06
SALES DEPT	ENG. DEPT	ACCT. DEPT	EXPORT DEPT	R & D DEPT	MARKET DEPT
07	08	09	10	11	12
13	14	15	16	17	18
19	20	21	22	23	24
25	26	27	28	29	30
31	32	P1	P2	P3	P4
P5	P6	P7	P8		

dotted line

***** -PANASONIC - *****
***** -HEAD OFFICE - ***** 201 555 1212- *****

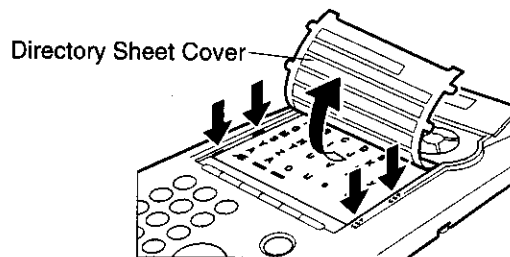

▶ Customizing Your Machine

Your facsimile machine has a variety of adjustable Fax Parameters. These parameters, listed in the Parameter Table, are preset for you and do not need to be changed. If you do want to make a change, read the table carefully. Some parameters, such as the Resolution, Contrast, and Verification Stamp parameters, can be temporarily changed by simple key operation just before a transmission is made. When the transmission ends, however, these parameters return to their preset values (Home position). Other parameters can only be changed by the procedure described below.

Setting the Fax Parameters

1

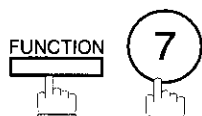

```
SET MODE      (1-6)
ENTER NO. OR ∨ ^
```

2

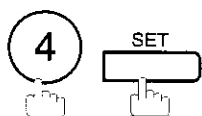

```
FAX PARAMETER (01-99)
NO. = ■
```

3

Enter Fax Parameter number from the Parameter Table.
(See pages 35 to 38)

Ex: ① ① for **CONTRAST**

```
FAX PARAMETER (01-99)
NO. = 01
```

4

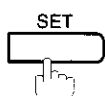

```
01 CONTRAST
1: NORMAL
```

5

Enter the new setting value.

Ex: ② for **LIGHTER**

```
01 CONTRAST
2: LIGHTER
```

6

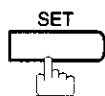

```
02 RESOLUTION
1: STANDARD
```

To set another parameter, press **CLEAR** to return to step 3 or press **STOP** to return to standby.

! Note:

1. To scroll the Fax Parameters in Step 2 or 4, press ▼ or ▲.
2. To print out a Fax Parameter List, see page 151.

Customizing Your Machine

Fax Parameter Table

No.	Parameter	Setting Number	Setting	Comments
01	CONTRAST	1	Normal	Setting the home position of the CONTRAST key.
		2	Lighter	
		3	Darker	
02	RESOLUTION	1	Standard	Setting the home position of the RESOLUTION key.
		2	Fine	
		3	S-Fine	
04	STAMP	1	Off	Setting the home position of the STAMP key. To select the stamp function when document is stored in memory, see Fax Parameter No. 28.
		2	On	
05	MEMORY	1	Off	Setting the home position of the MEMORY key.
		2	On	
06	DIALING METHOD	1	Pulse	Selecting the dialing method.
		2	Tone	
07	HEADER PRINT	1	Inside	Selecting the printing position of the header. Inside : Inside TX copy area. Outside : Outside TX copy area. No print : Header is not printed.
		2	Outside	
		3	No print	
08	HEADER FORMAT	1	Logo, ID No.	Selecting the header format.
		2	From To	
09	RCV'D TIME PRINT	1	Invalid	Selecting whether the machine prints the received date & time, remote ID, percentage of reduction and page number on the bottom of each received page.
		2	Valid	
10	KEY/BUZZER VOLUME	1	Off	Selecting the volume of the Key/Buzzer tone.
		2	Soft	
		3	Loud	
12	COMM. JOURNAL	1	Off	Selecting the home position of printout mode for COMM. Journal Off/Always/INC. Off : No printout Always : Always prints out Inc. only : Printout when communication has failed.
		2	Always	
		3	Inc. only	
13	AUTO JOURNAL PRINT	1	Invalid	Selecting whether the machine prints the journal automatically after every 100 transactions.
		2	Valid	
14	FILE ACCEPTANCE REPORT	1	Invalid	Selecting whether the machine prints the file acceptance journal. If you set this parameter to valid, a journal will print out after any memory communication.
		2	Valid	
17	RECEIVE MODE	1	Manual	Setting the reception mode to automatic or manual.
		2	Auto	
22	SUBSTITUTE RCV	1	Invalid	Selecting whether the machine receives to memory when recording paper runs out, toner runs out or recording paper is jammed.
		2	Valid	

Continued on the next page.

► Customizing Your Machine

No.	Parameter	Setting Number	Setting	Comments
24	PRINT REDUCTION	1	Fixed	Selecting print reduction mode. Fixed: Reduce received document according to setting of Parameter No. 25.
		2	Auto	Auto: Reduce received document according to the length of received documents.
25	REDUCTION RATIO	70	70%	Selecting fixed print reduction ratio from 70% to 100%. This parameter functions only when fixed print reduction is selected on Fax Parameter No. 24.
		----	----	
		100	100%	
26	POLLING PASSWORD		(----	Setting a 4-digit password for secured polling. (See page 68)
27	POLLED FILE SAVE	1	Invalid	Selecting whether the machine retains the polled document in memory even after the document is polled once.
		2	Valid	
28	STAMP AT MEM. XMT	1	Invalid	Selecting whether the machine stamps the original documents when storing the documents into memory. (depending on the Stamp setting on the Control Panel)
		2	Valid	
30	DRD SERVICE	1	Invalid	Selecting whether or not the machine is available "DRD Service". If this parameter is set to "Valid", your machine detects the specified ring pattern only to receive a document automatically.
		2	Valid	
31	INCOMPLETE FILE SAVE	1	Invalid	Selecting whether the machine retains the document in memory if the document is not successfully transmitted.
		2	Valid	
32	COPY REDUCTION	1	Manual	Selecting whether the machine performs the copy reduction ratio automatically or manually. Manual : The machine will prompt you for the Zoom ratio (100% to 70%) when making copies. Auto : The machine will automatically determine the reduction ratio according to the length of the original document.
		2	Auto	
33	XMT REDUCTION	1	Invalid	Selecting whether the machine performs reduction when the transmitting document is wider than the recording paper used at the receiving machine.
		2	Valid	
34	ENERGY SAVER MODE	1	Off	To reduce the power consumption in standby, select either Energy-Saver or Sleep mode and specify the Delay Time (1 to 120 minutes) for the machine to enter into the selected mode. The Delay Timer setting is only available in the Energy-Saver or Sleep Modes.
		2	Energy-Saver	Off : The unit will remain in standby mode and consume more energy than when in Energy-Saver or Sleep modes. Energy-Saver Mode: Saves energy by consuming less power than when in standby mode by turning off the fuser unit after the specified time.
		3	Sleep	Sleep Mode: This is the lowest power state that the machine enters after the specified time without actually turning off. (Sleep Mode is not available when the optional Parallel Port Interface Kit, Page Description Language Printer Interface Kit or G3 Communication Port Kit is installed)

Continued on the next page.

Customizing Your Machine

No.	Parameter	Setting Number	Setting	Comments
37	RCV TO MEMORY		(----	Enter a 4-digit password used to print out the received document in memory by using F8-5 (RCV TO MEMORY). When F8-5 is set to On, this parameter will not be shown on the LCD display. (See page 87)
38	ACCESS CODE		(----	Enter a 4-digit Access Code to secure the machine from unauthorized use. (See page 85)
40	RELAY XMT REQUEST	1	Invalid	Selecting whether the machine accepts and performs Relay XMT Request. (See page 125)
		2	Valid	
41	CONF. FAX PARAMETER	1	Invalid	Selecting whether the machine performs Confidential Network Communication. (See page 125)
		2	Valid	
42	CONF. POLLED FILE SAVE	1	Invalid	Selecting whether the machine saves the confidential polled file even after the file is polled once.
		2	Valid	
43	PASSWORD-XMT	1	Off	Setting a 4-digit XMT-Password and selecting whether the machine performs and checks the XMT-Password of the receiving station when transmitting. (See page 113)
		2	On	
44	PASSWORD-RCV	1	Off	Setting a 4-digit RCV-Password and selecting whether the machine performs and checks the RCV-Password of the transmitting station when receiving. (See page 114)
		2	On	
46	SELECT RCV	1	Invalid	Selecting whether the machine performs selective reception. (See page 111)
		2	Valid	
48	TELEPHONE LINE	1	PSTN	Selecting the type of line connected.
		2	PBX	
49	PSTN ACCESS CODE		0---	Setting PSTN Access Code. (max. 4 digits)
50	FLASH KEY	1	Earth	Selecting to use FLASH on control panel either as Earth key or Flash key.
		2	Flash	
52	DIAGNOSTIC PASSWORD		(----	Setting the password for Remote Diagnostic Mode. Please ask your Panasonic Authorized Dealer for details.
53	SUB-ADDRESS PASSWORD		(----	Setting a 20-digit password for secured sub-address communication.
54	FAX FORWARD	1	Invalid	Selecting whether the machine performs Fax Forwarding to the specified destination. (See page 92)
		2	Valid	
56	COVER SHEET	1	Off	Setting the home position of the Cover Sheet parameter in the Select Mode. (See page 90)
		2	On	
58	LANGUAGE	1	English	Selecting the language to be shown on the display and reports.
		2	French	
60	OPTION PAGE MEMORY (D-RAM Card)	1	0MB	Set the size of the page memory to match the optional Expansion D-RAM Card installed in the machine. (See page 171)
		2	2MB	
		3	4MB	
		4	8MB	

Continued on the next page.

► Customizing Your Machine

No.	Parameter	Setting Number	Setting	Comments
65	PRINT COLLATION	1	Invalid	Selecting whether the machine prints out documents in sequence. (See page 63)
		2	Valid	
77	LOGO/DEPT. CODE	1	Invalid	Selecting whether the machine performs the Multiple Logo or Department Code operation. (See pages 97 and 106)
		2	Multi-LOGO	
		3	Dept.Code	
82	QUICK MEMORY XMT	1	Invalid	Selecting whether the machine performs Quick Memory Transmission. (See page 46 to 49)
		2	Valid	Invalid: Stores all documents into memory first before dialing the telephone number. Valid: Starts dialing the telephone number immediately after storing the first page.
88	LINE SELECTION [See Note 2]	1	Auto	Setting the home position of the Telephone Line selection.
		2	Line 1	Auto: Selects the available telephone line for transmission automatically. Line1: Selects this as the default telephone line, unless manually selecting an alternate phone line.
		3	Line 2	Line2: Selects this as the default telephone line, unless manually selecting an alternate phone line.
99	MEMORY SIZE (Flash Memory)	-	-	Displays the amount of base and optional memory installed. (Base Memory + Optional Memory)



Note:

1. The standard settings are printed on the Fax Parameter List. To print out Fax Parameter List, see page 151.
2. This parameter is available only when the G3 Communication Port Option is installed.
3. The contents of Fax Parameter may differ depending on the each country's regulation or specification.

Loading Documents

Documents You Can Send

In general, your machine will send any document printed on A4 size paper.

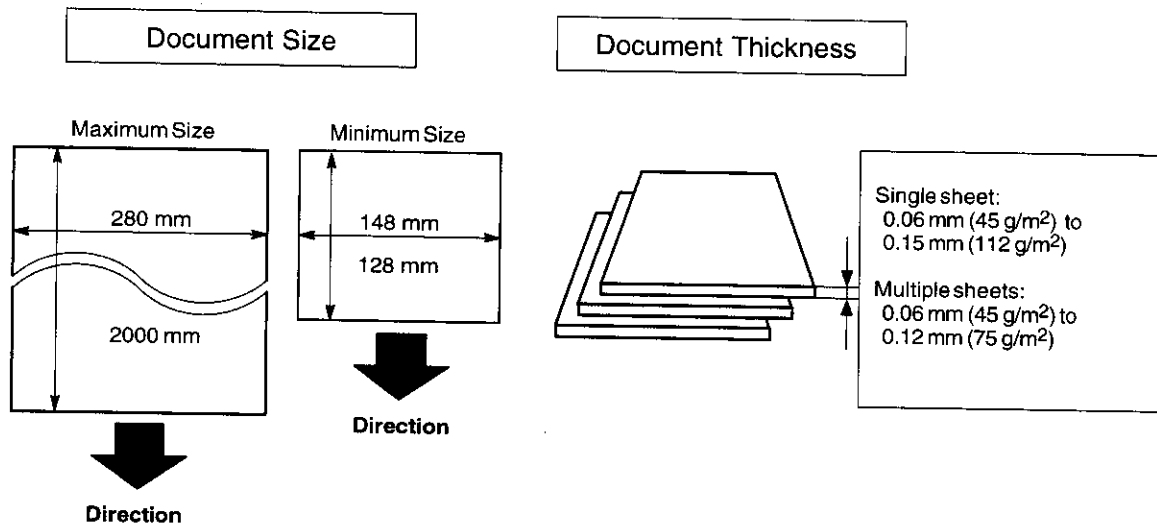

4

Documents You Cannot Send

You must never try to send documents that are:

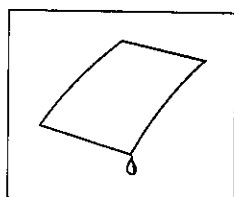

Wet

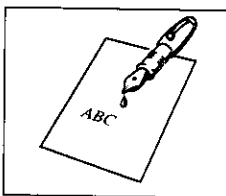

Covered with wet ink or paste

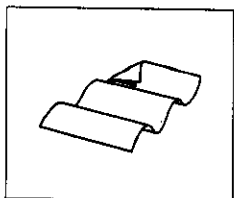

Too thin (e.g., onionskin, airmail paper, pages from some magazines, etc.)

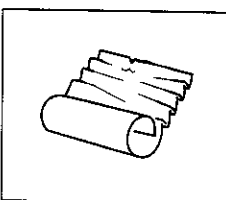

Wrinkled, curled or folded

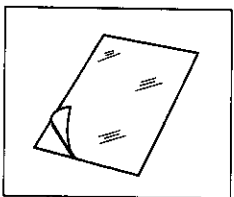

Coated (e.g., glossy paper, etc.)

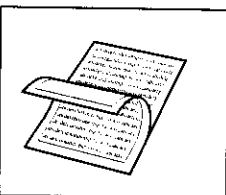

Chemically processed (e.g., pressure-sensitive paper, carbon-coated paper, etc.) or made of cloth or metal

To transmit these kinds of documents, make a photocopy first and then transmit the copy instead.

▶ Loading Documents

How to Load Documents

1. Be sure the document(s) is free of staples, paper clips and is not torn, greasy or covered by foreign objects.
2. Place the document(s) **FACE DOWN** on the Automatic Document Feeder (ADF) until the leading edge placed into the machine stops.
If you are sending multiple pages, make sure that **the bottom sheet enters first**. You can also stack **up to 50 PAGES** on the ADF at one time. If you have more than 50 pages, wait until transmission or storing in memory starts as pages feed through, place any remaining pages on top of the last page in the feeder.
3. Adjust the Document Guides to center the document on the ADF.

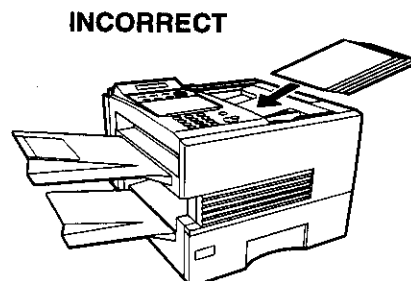
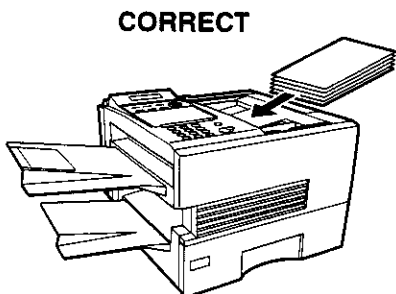
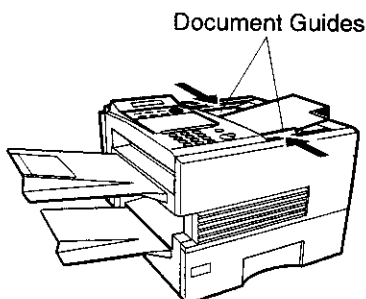

When you set a document on the ADF, the display message will change from date and time (standby) to the following message. You can now change basic transmission settings, or begin the dialing procedure.

ENTER STATION(S)
THEN PRESS START 00%



Note:

1. Transmitting documents longer than 356 mm requires user's assistance.
2. When transmitting documents longer than A4 size, please extend the sub-tray as shown below.

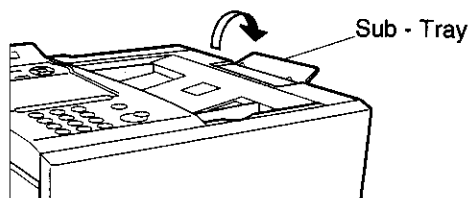

Basic Transmission Settings

You can temporarily change the transmission settings either before or after you place the document on the ADF. These settings are as follows;

- Contrast
- Resolution
- Halftone
- Stamp
- Communication Journal

After your document has been sent, your machine will automatically return to the preset settings.

4

Contrast

Your machine is preset to **Normal** contrast. If you wish to send a document with lighter contrast, change the setting to **Lighter**. If you wish to send a document with darker contrast, change the setting to **Darker**.

Press **CONTRAST** to:

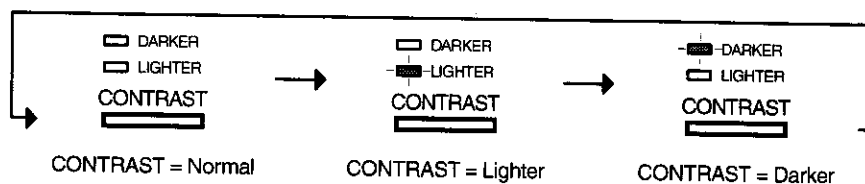

Resolution

Your machine is preset to **Standard** resolution, which is suitable for most documents. Use **Fine** or **Super Fine** for detailed documents.

Press **RESOLUTION** to:

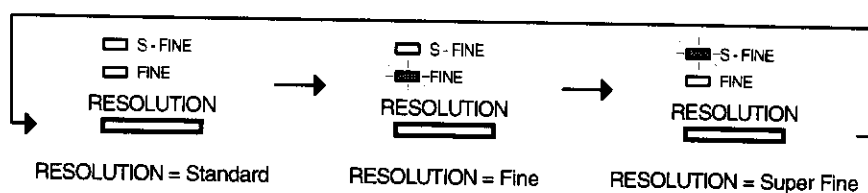

! Note:

1. To change the preset Contrast position, change the setting of Fax Parameter No. 01. (See page 35)
2. To change the preset Resolution position, change the setting of Fax Parameter No. 02. (See page 35)
3. If you send a photographic document with Halftone set to Fast or Quality and the Resolution set to Super Fine (16 pels/mm x 15.4 lines/mm), the reproduction of the received document will be determined by the capability of the remote station.

▶ Basic Transmission Settings

Halftone

The Halftone setting is useful when sending photographs or illustrations with gray tones. Your machine is preset to HALFTONE = Off. You can select either Fast or Quality mode.

Press **HALFTONE** to:

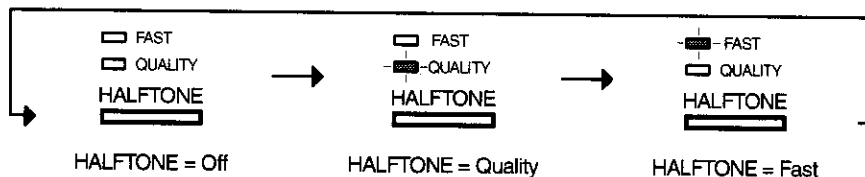

Verification Stamp

The Verification Stamp helps you to confirm successful transmissions by stamping the bottom of each successfully transmitted page with a small ⊗ mark.

Press **STAMP** to:

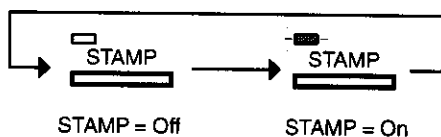

! Note:

1. When you select HALFTONE, FAST or QUALITY, your machine will automatically select Fine Resolution.
2. When you store a document in memory, the Verification Stamp will stamp on the document if it is successfully stored in memory. In this case the Verification Stamp is not a confirmation that the document was successfully transmitted. If you wish to disable the use of the Verification Stamp when storing document in memory, change the setting of Fax Parameter No. 28. (See page 36)
3. To change the preset Verification Stamp position, change the setting of Fax Parameter No. 04. (See page 35)

Basic Transmission Settings

Communication Journal (COMM. JOURNAL)

A Communication Journal lets you verify if the transmission was successful. You can select the condition to print out the Communication Journal as follows.

When you set COMM. JOURNAL = OFF:

a Communication Journal will not be printed out.

When you set COMM. JOURNAL = ON :

a Communication Journal is printed out automatically after every communication.

When you set COMM. JOURNAL = INC.:

a Communication Journal is printed out automatically only if the communication has failed.

4

1

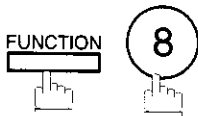

SELECT MODE (1-5)
ENTER NO. OR V ^

2

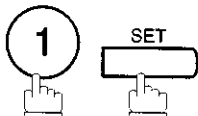

COMM. JOURNAL=INC
1:OFF 2:ON 3:INC

3

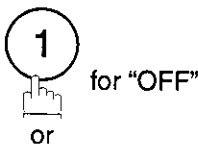

for "OFF".

or

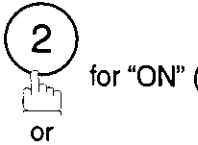

for "ON" (Always print out).

or



for "INCOMPLETE" only.

COMM. JOURNAL=OFF
1:OFF 2:ON 3:INC

or

COMM. JOURNAL=ON
1:OFF 2:ON 3:INC

or

COMM. JOURNAL=INC
1:OFF 2:ON 3:INC

4



! Note: 1. To change the preset Comm. Journal condition, change the setting of Fax Parameter No. 12. (See page 35)

▶ Sending Documents

You can choose either Memory or Direct Transmission.

Use Memory Transmission if:

- You want to send the document to multiple stations.
- You have to retrieve the document immediately.
- You want to take advantage of Dual Operation design.
- You want to take advantage of Batch Transmission.

Use Direct Transmission if:

- The memory is full.
- You want to send the document immediately.

Use Voice Mode Transmit if:

- You want to send the document after talking with the other party.
- You want to send the document after listening to a voice prompting.

Memory Transmission

Your machine quickly stores the document into the machine's memory. Then, starts to dial the telephone number.

If the transmission fails, your machine will re-transmit the remaining unsuccessful page(s) automatically.

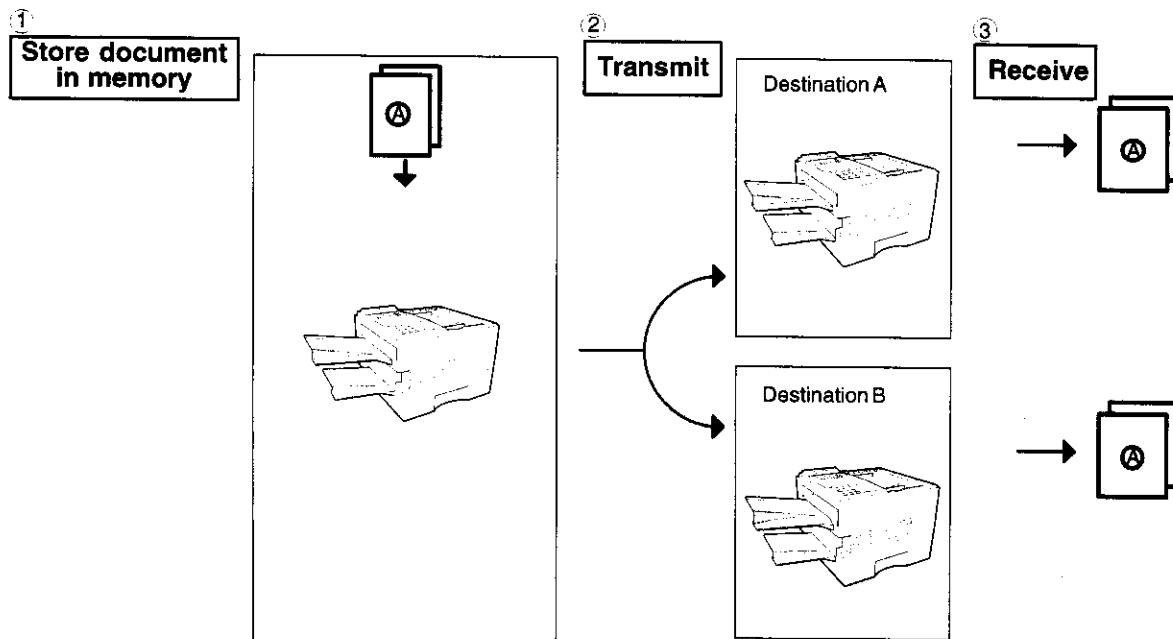

Sending Documents

! Note:

1. The File Number of the document being stored is shown at the upper right corner of the display while storing the document. It is also printed on the Communication Journal (COMM. JOURNAL), Transaction Journal and File List. The percentage of memory used is shown on the lower right corner of the display after each page is stored.

```
* STORE *      NO.003
PAGES=002  10%
```

```
* STORE * COMPLETED
TOTAL PAGES=005  30%
```

```
MEMORY OVERFLOW
INFO. CODE=870
```

```
15 PAGES COMPLETED
DELETE? 1:YES 2:NO
```

2. If memory overflow occurs while storing documents, the remaining documents on the ADF will be ejected. The machine prompts you whether to transmit the successfully stored documents or to cancel the transmission. Press **1** to cancel or press **2** to transmit.

If Fax Parameter No. 82 (Quick Memory XMT) is set to "Invalid", the machine stores all the documents into memory first before transmitting.

After storing each document, the machine checks the available memory to prevent memory overflow and stops storing additional documents if the stored data approaches a certain percentage* (around 80%).

Then the machine dials and sends the memory stored documents first and continues the transmission of the remaining documents from the ADF during the same phone call.

If transmitting to multiple stations or if memory overflows while storing a document, the machine prompts you whether to transmit the successfully stored documents or to cancel the transmission. Press **1** to cancel or press **2** to transmit.

See the Specifications on page 168 for the image memory capacity.

If no action is taken within 10 seconds, the machine will start transmitting the stored documents.

* The percentage varies and its dependent on the type of documents you are storing, machine settings or whether an optional memory card is installed.

3. An Information Code will be displayed if the transmission has failed or no answer at the receiving side after the last automatic redial.

The document stored for this transmission will be erased from the memory automatically and the information code is printed for the transmission on the Communication Journal (COMM. JOURNAL).

If you need to retain the incomplete documents even after the last redial, change Fax Parameter No. 31 (INC. FILE SAVE) to "Valid" in advance. (See page 36) To retry the incomplete documents, refer to page 84.

```
INCOMPLETE
INFO. CODE=XXX
```

4. To stop the transmission, press **STOP**.

The display shows:

```
COMMUNICATION STOP?
1:YES 2:NO
```

Press **1** to stop the transmission. The document you stored will be erased automatically.

If you do not want to erase the documents, change the setting of Fax Parameter No. 31 (INC. FILE SAVE) to "Valid" in advance. (See page 36)

Then the following display will appear and you can select whether to save the file as an incomplete file for editing and retry, or delete the file manually.

```
SAVE AS INCOMP.FILE?
1:YES 2:NO
```

5. If you would like to print a Communication Journal (COMM. JOURNAL) after stopping a transmission, press **1** when the display shows:

```
PRINT COMM. JOURNAL?
1:YES 2:NO
```

▶ Sending Documents

Manual Number Dialling

To dial the telephone number manually, follow the steps below.

1



Set document(s) face down.

ENTER STATION(S)
THEN PRESS START 00%

2



Make sure that the MEMORY lamp is on.

If not, press **MEMORY** to set "On".

3

Enter a telephone number from the keypad.

Ex: (5) (5) (5) (1) (2) (3) (4)

TEL. NO.
5551234■

4

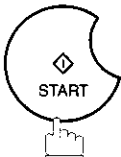

The document(s) begin to store into memory with a file number.

Then starts dialling the telephone number immediately after storing the first page. (See Note 3)

The remaining page(s) continue to store into memory.

* STORE * NO.002
PAGES=001 05%

* DIALLING * NO.002
5551234

! Note:

1. If you need a special access number to get an outside line, dial it first then press **PAUSE** to enter a pause (represented by a "-") before dialling the full number.
Ex: 9 PAUSE 5551234
2. If you are using Pulse dialling and you wish to change to Tone dialling in the middle of dialling, press **TONE** (represented by a "/").
The dialling mode will be changed from Pulse to Tone after dialling the digit "/".
Ex: 9 PAUSE TONE 5551234
3. This feature is called "Quick Memory Transmission". If you wish to store All the document(s) into memory first before transmitting, change the Fax Parameter No. 82 (QUICK MEMORY XMT) to "Invalid". (See page 38)

Sending Documents

One-Touch Dialling

One-Touch Dialling allows you to dial a full telephone number by pressing a single key. To set up the One-Touch keys, see page 29.

1



Set document(s) face down.

ENTER STATION(S)
THEN PRESS START 00%

4

2



Make sure that the MEMORY lamp is on.
If not, press **MEMORY** to set "On".

3

Press a One-Touch key.

Ex:

<01>(Station name)
5551234

4

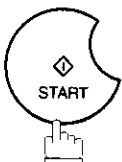

* STORE * NO.002
PAGES=001 05%

The document(s) begin to store into memory with a file number.
Then starts dialling the telephone number immediately after storing the first page. (See Note 1)
The remaining page(s) continue to store into memory.

* DIALLING * NO.002
(Station name)



Note:

1. This feature is called "Quick Memory Transmission". If you wish to store All the document(s) into memory first before transmitting, change the Fax Parameter No. 82 (QUICK MEMORY XMT) to "Invalid". (See page 38)

▶ Sending Documents

Abbreviated Dialling

Abbreviated dialling is a speedy way to dial a frequently dialed telephone number by preprogramming the telephone number into the built-in auto-dialer with a 3-digit abbreviated code. To program an abbreviated dialling number, see page 30.

1



Set document(s) face down.

```
ENTER STATION(S)  
THEN PRESS START 00%
```

2



Make sure that the MEMORY lamp is on.
If not, press **MEMORY** to set "On".

3

Press **ABBR** then enter a 3-digit code.

Ex: **ABBR** **0** **1** **0**

```
[010] (Station name)  
5553456
```

4

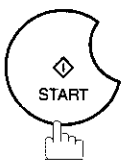

The document(s) begin to store into memory with a file number.
Then starts dialling the telephone number immediately after storing the first page. (See Note 1)
The remaining page(s) continue to store into memory.

```
* STORE * NO.002  
PAGES=001 05%
```

```
* DIALLING * NO.002  
(Station name)
```

! Note:

1. This feature is called "Quick Memory Transmission". If you wish to store All the document(s) into memory first before transmitting, change the Fax Parameter No. 82 (QUICK MEMORY XMT) to "Invalid". (See page 38)

Sending Documents

Directory Search Dialling

Directory Search dialling allows you to dial a full telephone number by searching the station name entered in One-Touch keys or Abbreviated dialling numbers.

1



Set document(s) face down.

ENTER STATION(S)
THEN PRESS START 00%

2



Make sure that the MEMORY lamp is on.

If not, press **MEMORY** to set "On".

3



ENTER LETTER(S)

4

Enter the full station name or part of a station name by using the Character keys. (See page 12)

ENTER LETTER(S)
PANA

Ex: **P** **A** **N** **A** for searching **PANASONIC**

5

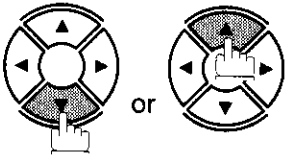

or

[010] PANASONIC
5553456

repeatedly until the display shows the station name you want to send to.

6

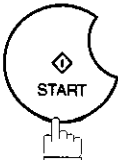

* STORE * NO.002
PAGES=001 05%

The document(s) begin to store into memory with a file number.

Then starts dialling the telephone number immediately after storing the first page. (See Note 1)

The remaining page(s) continue to store into memory.

* DIALLING * NO.002
PANASONIC



Note:

1. This feature is called "Quick Memory Transmission". If you wish to store All the document(s) into memory first before transmitting, change the Fax Parameter No. 82 (QUICK MEMORY XMT) to "Invalid". (See page 38)

4

▶ Sending Documents

Multi-Station Transmission (Broadcasting)

If you have to send the same document(s) to multiple stations, you can save time in feeding the document(s) by using memory transmission. That is, you can store the document(s) into memory and then send it to the station(s) automatically.

1



Set document(s) face down.

ENTER STATION(S)
THEN PRESS START 00%

2



Make sure that the MEMORY lamp is on.

If not, press **MEMORY** to set "On".

3

Dial by any combination of the following methods:

- One-Touch Dialling
- Abbreviated Dialling
- Manual Number Dialling, press **SET** after each station is entered
(UF-895: Up to 70 stations, UF-885: Up to 32 stations)
- Directory Search Dialling, press **SET** after each station is entered
(For details, see page 46 to 49.)

Ex: 01



If you want to confirm the number of stations you have entered, press **SET**.

<01>(Station name)
5551234

[010](Station name)
5553456

2 STN(S) ARE SET
ADD MORE OR START

4

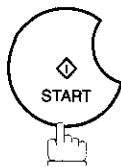

All document(s) are stored into memory with a file number.
(See Note 2)
Then starts dialling the telephone numbers in sequence.

* STORE * NO.001
PAGES=001 01%

* STORE * COMPLETED
TOTAL PAGE=005 25%

* DIALLING * NO.001
(Station name)

! Note:

1. You can review the stations you entered in step 3 before storing your document into memory by pressing **▼** or **▲**. Press **CLEAR** to clear an entered station or group shown on the display if needed.
2. The "Quick Memory Transmission" is disabled if multiple stations are set.

Sending Documents

Direct Transmission

If your machine's memory is full or you wish to send the document immediately, use Direct Transmission.

Manual Number Dialling (Direct Transmission)

To dial the telephone number manually, follow the steps below.

1



Set document(s) face down.

ENTER STATION(S)
THEN PRESS START 00%

2

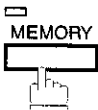

Make sure that the lamp goes off.

ENTER STATION
00%

3

Enter a telephone number from the keypad.

Ex: (5) (5) (5) (1) (2) (3) (4)

PRESS START TO DIAL
5551234

4

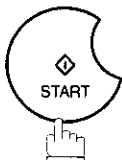

Your machine starts to dial the telephone number.

* DIALLING *
5551234

! Note:

1. If you need a special access number to get an outside line, dial it first then press **PAUSE** to enter a pause (represented by a "-") before dialling the full number.
Ex: 9 PAUSE 5551234
2. If you are using Pulse dialling and you wish to change to Tone dialling in the middle of dialling, press **TONE** (represented by a "/").
The dialling mode will be changed from Pulse to Tone after dialling the digit "/".
Ex: 9 PAUSE TONE 5551234
3. To stop the transmission, press **STOP**.

The display shows:

COMMUNICATION STOP?
1: YES 2: NO

Press **1** to stop the transmission. The Communication Journal will not print out regardless of the printout mode setting of the Communication Journal.

4

▶ Sending Documents

One-Touch Dialling (Direct Transmission)

One-Touch Dialling allows you to dial a full telephone number by pressing a single key. To set up the One-Touch keys, see page 29.

1



Set document(s) face down.

ENTER STATION(S)
THEN PRESS START 00%

2



Make sure that the lamp goes off.

ENTER STATION
00%

3

Press a One-Touch key.

Ex:

The display will show the One-Touch number and station name. The full number (e.g. 5551234) will then be dialed.

<01> (Station name)
5551234

* DIALLING *
(Station name)

Sending Documents ◀

Abbreviated Dialling (Direct Transmission)

Abbreviated dialling is a speedy way to dial a frequently dialed telephone number by preprogramming the telephone number into the built-in auto-dialer with a 3-digit abbreviated code. To program an abbreviated dialling number, see page 30.

1



Set document(s) face down.

ENTER STATION(S)
THEN PRESS START 00%

4

2



Make sure that the lamp goes off.

ENTER STATION
00%

3

Press **ABBR** and a 3-digit code.

Ex: **ABBR** **0** **1** **0**

[010] (Station name)
5553456

The display will show the ABBR number and station name.
The full number (e.g. 5553456) will then be dialed.

* DIALLING *
(Station name)

▶ Sending Documents

Directory Search Dialling (Direct Transmission)

Directory Search dialling allows you to dial a full telephone number by searching the station name entered in One-Touch keys or Abbreviated dialling numbers.

1



Set document(s) face down.

ENTER STATION(S)
THEN PRESS START 00%

2



Make sure that the lamp goes off.

ENTER STATION
00%

3



ENTER LETTER(S)
■

4

Enter the full station name or part of a station name by using the Character keys. (See page 12)

ENTER LETTER(S)
PANA■

Ex: **P** **A** **N** **A** for searching **PANASONIC**

5

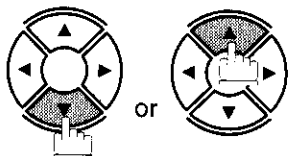

repeatedly until display shows the station name you want to send to.

[010] PANASONIC
5553456

6

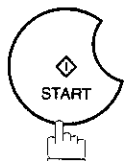

The full number (e.g. 5553456) will be dialed.

* DIALLING *
PANASONIC

Sending Documents

Voice Mode Transmission

If you wish to send the document after talking with other party, use Voice Mode Transmission. Your machine requires an optional fax handset or an external telephone.

Off-Hook Dialling

For Off-Hook Dialling, follow the steps below.

1



Set document(s) face down.

ENTER STATION(S)
THEN PRESS START 00%

2

Lift the fax handset or the external telephone and dial the telephone number from the keypad.

Ex: ⑤⑤⑤①②③④

3

When you hear the voice of the other party, tell the other party to prepare to receive a document.

ON LINE * XMT *
5551234

Then, when you hear a beep,

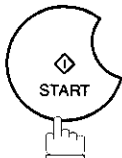

and hang up the handset.

! Note:

- To stop the transmission, press **STOP**.

The display shows:

COMMUNICATION STOP?
1: YES 2: NO

Press ① to stop the transmission. The Communication Journal will not print out regardless of the printout mode setting of the Communication Journal.

4

▶ Sending Documents

On-Hook Dialling

For On-Hook Dialling, follow the steps below.

1



Set document(s) face down.

ENTER STATION(S)
THEN PRESS START 00%

2



You will hear dial tone through the monitor speaker.

* MONITOR *

3

Dial the telephone number from the keypad.

Ex: (5) (5) (5) (1) (2) (3) (4)

* DIALLING *
5551234

4

When you hear a beep,

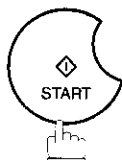

ON LINE * XMT *
5551234

! Note:

1. If you need a special access number to get an outside line, dial it first then press **PAUSE** to enter a pause (represented by a "-") before dialling the full number.
Ex: 9 PAUSE 5551234
2. If you are using Pulse dialling and you wish to change to Tone dialling in the middle of dialling, press **TONE** (represented by a "/").
The dialling mode will be changed from Pulse to Tone after dialling the digit "/".
Ex: 9 PAUSE TONE 5551234

Sending Documents

Transmission Reservation

You can do the following while sending a document from memory or receiving a document.

- Reserve the next transmission into memory for up to 70* different files. (* UF-885 : 30 different files)
- Reserve a priority transmission.

Memory Transmission Reservation (Multi-tasking)

If your machine is on-line busy transmitting from memory, receiving or printing received documents, you can reserve a transmission by the following procedure.

4

1 Your machine is on-line, the ON LINE lamp is blinking or printing received documents.

```
ON LINE * MEM.XMT *
ID:(Identification)
```

```
ON LINE * RCV *
ID:(Identification)
```

```
ON LINE
PC MODE
```

```
* PRINTING *
MEMORY RCV'D DOC
```

```
ENTER STATION(S)
THEN PRESS START 00%
```

2  Set document(s) face down.

3  MEMORY

Make sure that the MEMORY lamp is on.

If not, press **MEMORY** to set "On".

4 Dial by any combination of the following methods:

- One-Touch Dialling
- Abbreviated Dialling
- Manual Number Dialling, press **SET** after each station is entered (UF-895: Up to 70 stations, UF-885: Up to 32 stations)
- Directory Search Dialling, press **SET** after each station is entered (For details, see page 46 to 49.)

Ex:

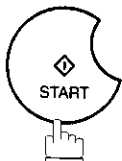
5  START

Your machine will store the document(s) into memory.

```
<01>(Station name)
5551234
```

```
* STORE * NO.005
PAGES=001 01%
```

```
* STORE * COMPLETED
TOTAL PAGES=005 25%
```

! Note:

1. To cancel the memory transmission reservation, see page 81.
2. If the same station has been reserved with different files, the files will be executed in a single transmission (Batch Transmission). (See page 65)

▶ Sending Documents

Direct Transmission Reservation (Priority Transmission Reservation)

If you are in a rush to send an urgent document, however there are many files in the memory, use Direct Transmission Reservation to send the urgent document. The urgent document will be sent immediately after the current communication is finished.

Note that you cannot send documents to multiple stations.

To reserve your machine for sending the urgent documents

- 1 Your machine is on-line, the ON LINE lamp is blinking or printing received documents.

```
ON LINE * MEM.XMT *  
ID: (Identification)
```

```
ON LINE * RCV *  
ID: (Identification)
```

```
ON LINE  
PC MODE
```

```
* PRINTING *  
MEMORY RCV'D DOC
```

```
ENTER STATION(S)  
THEN PRESS START 00%
```

2



Set document(s) face down.

3

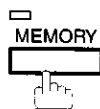

Make sure that the lamp goes off.

```
ENTER STATION  
00%
```

4

Dial by using any one of the following methods:

- One-Touch Dialling
- Abbreviated Dialling
- Manual Number Dialling and press **START**
- Directory Search Dialling and press **START**
(For details, see pages 51 to 54.)

Ex:

You can reserve sending an urgent document to a single station only.

A message "DIRECT XMT RESERVED" will be shown on the display.

```
<01> (Station name)  
5551234
```

```
DIRECT XMT RESERVED  
<01> (Station name)
```

To cancel the direct transmission reservation

- 1 Make sure the document is on the ADF.

```
DIRECT XMT RESERVED  
<01> (Station name)
```

2



```
CANCEL XMT RESERVE?  
1: YES 2: NO
```

3

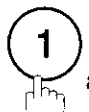

and then remove the document from ADF.

Sending Documents

Redialling

Automatic Redialling

If a busy line is detected, the machine will redial the number up to 5 times at 3 minutes interval. However, if a busy line is not detected, the machine will redial only one time. During that time, a message will appear as shown to the right.

A file number is shown in the upper right hand corner of the display if it is a memory transmission file.

WAIT TO DIAL NO.001
(Telephone number)

4

Manual Redialling

You can also redial the last dialed number manually by pressing **REDIAL** key.

To redial the last dialed number through memory

1



Set document(s) face down.
Make sure that the MEMORY lamp is on.

ENTER STATION(S)
THEN PRESS START 00%

2

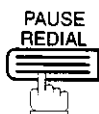

TEL. NO.
5551234

3

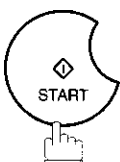

The document is stored into memory with a file number.
Then dials the last dialed number.

* STORE * NO.002
PAGES=001 01%

* DIALLING * NO.002
5551234

To redial the last dialed number through ADF

1



Set document(s) face down.

ENTER STATION(S)
THEN PRESS START 00%

2



Make sure that the lamp goes off.

ENTER STATION
00%

3

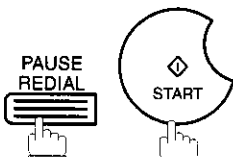

Your machine starts to dial the last dialed number.

PRESS START TO DIAL
5551234

* DIALLING *
5551234

! Note:

1. While the unit is displaying "WAIT TO DIAL", you can press **REDIAL** to start redialling immediately.

▶ Receiving Documents

Your machine is provided with both automatic and manual reception modes. The selection of either reception mode is made with Fax Parameter No. 17 (RCV MODE).

Automatic Reception

Your machine will receive documents automatically if the Fax Parameter No. 17 (RECEIVE MODE) is set to "Auto". (See page 35)

Manual Reception

You may wish to receive documents manually if you use the telephone line in your office primarily as a personal telephone and occasionally for your facsimile machine.

To receive documents manually, change the Fax Parameter No. 17 (RECEIVE MODE) to "Manual" (See page 35) and the following message will be shown on the display.

12-JAN-1999 15:00
MANUAL RCV 00%

To receive documents manually

- 1** When the telephone rings, lift the handset. (See Note 1)
If you hear a beep, the sound tells you that someone wants to send a document.

* PHONE OFF HOOK *
00%

- 2** Remove any documents from the ADF.

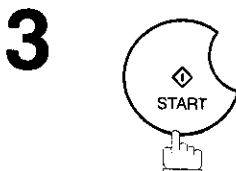

Your machine starts receiving the document.

ON LINE * RCV *

- 4** Hang up the telephone.

! Note:

1. Your machine requires an optional fax handset or an external telephone connected to the TEL jack on the left side of the machine.
2. If you receive a document with Super Fine resolution (406 pels/inch x 391 lines/inch), it might be divided into multiple pages with no reduction.

Print Reduction

This machine can use Letter, Legal or A4 size plain paper for recording. Sometimes, oversized documents sent to you by the other parties cannot be printed within a single page. When this occurs, the document will be divided into separate pages.

This machine is equipped with a Print Reduction function to solve this problem. You may select the most appropriate setting from the selections described below.

1. Automatic Reduction

Each page of a received document is first stored in memory. Based on the document length, your machine will automatically calculate the suitable reduction ratio (70% to 100%) to print the entire document on a single page. If the received document is extremely long (over 39% longer than the recording paper), the document will be divided into separate pages and print without reduction.

2. Fixed Reduction

You can pre-determine the reduction ratio from 70% to 100% in 1% steps. The document(s) you receive will be reduced to the fixed ratio regardless of size.

Selecting the Print Reduction Mode

Set Fax Parameters as shown below. (See page 36)

1. To set Automatic Reduction mode.

- (1) No. 24 Print Reduction set to "Auto".

2. To set Fixed Reduction mode.

- (1) No. 24 Print Reduction set to "Fixed".

- (2) No. 25 Reduction Ratio set to any number between 70% through 100%. (See Note 1)

EX: A4 to A4 - 96%

A4 to Letter - 90%

Letter to Letter - 96%

Legal to Letter - 75%

 **Note:**

1. If the sending side is set to print the header on the outside of the copy area, more reduction ratio will be required.

▶ Receiving Documents

Receiving Oversize Documents

If the received document is extremely long (over 39% longer than the recording paper), the document will be divided into separate pages. When printing on separate pages, the bottom 10 mm of first page will be overlapped on top of the next page.

Transmitted Document

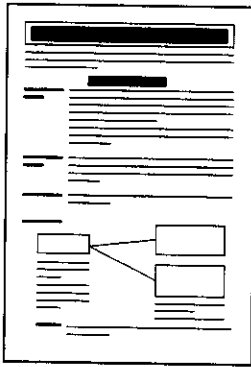

Received Document

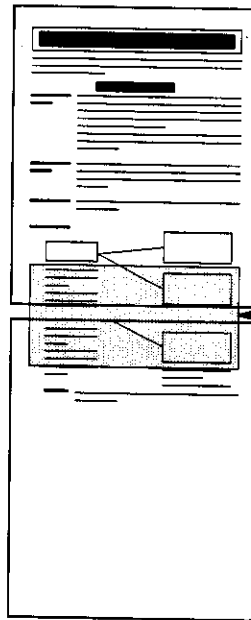
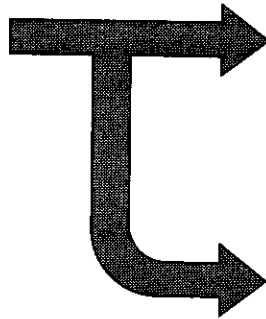

Overlap print.
10 mm

The receiving document is divided into two sheets with overlap printing.

! **Note:**

1. If the reduction method is set to the Automatic Reduction mode, the document is printed out with no reduction when printing out separate pages. If the reduction method is set to Fixed Reduction mode, the document is printed out by the ratio you set in Fax Parameter No. 25.

Receiving Documents

Substitute Memory Reception

If the recording paper runs out or jams or if the toner runs out during reception, the machine automatically starts receiving documents into its image data memory. Stored documents are printed automatically after replacing the recording paper or the toner cartridge. (See Note 1 and 2)

- 1 When the machine finishes the memory reception and there is no recording paper or toner, an Information Code appears on the display.

NO RECORDING PAPER
INFO. CODE=010

OUT OF TONER
INFO. CODE=041

- 2 Install the recording paper (See page 18) or replace the toner cartridge (See page 16).

* PRINTING *
MEMORY RCV'D DOC

The machine will automatically start printing the document stored in the memory.

4

Print Collation Mode

The printing mechanism of the UF-885/895 is a Reverse Order Stacking construction. The UF-885/895 has a Print Collation Mode that stacks received documents in the correct order. When the Print Collation Mode is enabled, all received documents are stored into memory first, then printed out in Correct Order Stacking. The requirements for the Print Collation Mode to be active are; 1) Fax Parameter No. 65 PRINT COLLATION set to "Valid", and 2) enough remaining memory.

The unit will print in Reverse Order Stacking (Non-Collation Mode) whenever one of the above requirements is not met.

To use this function, we recommend installing an Optional Flash Memory Card. See page 171 (Options and Supplies).

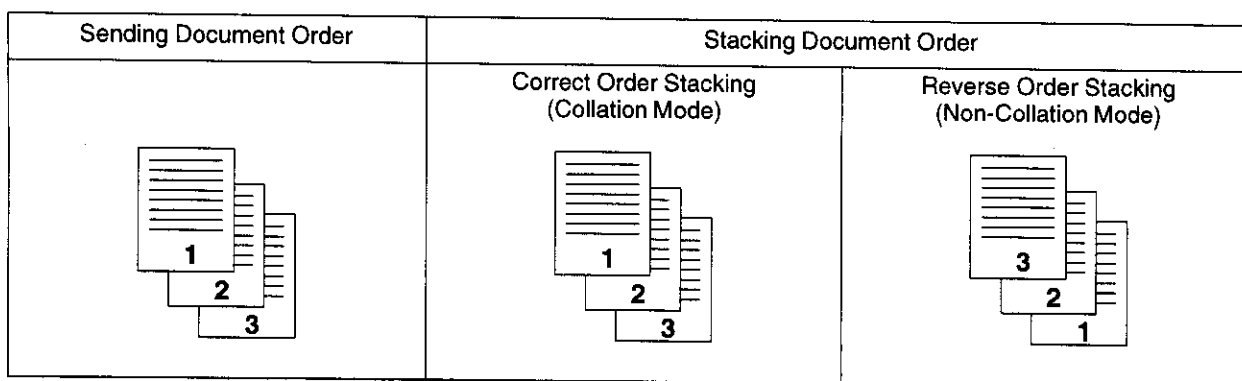

! Note:

1. If the memory overflows, the machine will stop receiving and release the communication line. The document(s) stored in the memory up to that moment will be printed out.
2. If you wish to turn off the substitute reception function, change the setting of Fax Parameter No. 22 to "Invalid". (See page 35)

Making Copies

Your machine has a copy function which can make single or multiple copies. When copying, your machine will automatically select Fine resolution.

1



Set document(s) face down.

ENTER STATION(S)
THEN PRESS START 00%

2



COPY
NO. OF COPY=1

3

Enter the number of copies.

Ex: (1)(0)

COPY
NO. OF COPY=10

4

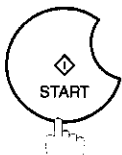

* STORE * NO.005
PAGES=001 01%

The machine stores the document, then prints the copies.

* COPY *
NO. OF COPY=01/10

! Note:

1. The copy will be reduced automatically depending on the length of the original document. If you wish to be prompted for the reduction ratio when making copies, change the setting of Fax Parameter No. 32 (COPY REDUCTION) to "Manual". (See page 36) If Copy Reduction is set to Manual, press and to set the zoom ratio in 1% steps. (100% to 70%)
2. If you make a copy with Super Fine resolution, it will be reduced slightly even if the reduction ratio is set to 100% in order to fit the data on one page.
3. Standard Resolution is not available in Copy Mode.
4. [For UF-885]
An optional D-RAM Card is required when copying a Legal size document with the settings on Super Fine resolution and the reduction ratio at 100%. If no optional D-RAM Card is installed, the bottom portion of the document will be cut off.

Batch Transmission

To reduce transmission time and cost, this feature allows your machine to accumulate different documents for the same destination(s) to be transmitted in a single phone call.

Real-time Batch Transmission

During memory transmission, your machine searches its memory for reserved files (up to 4 files) to transmit to the same destination, automatically batching and transmitting them in a single phone call.

The following is an example to show Real-time Batch Transmission. (See Note 1)

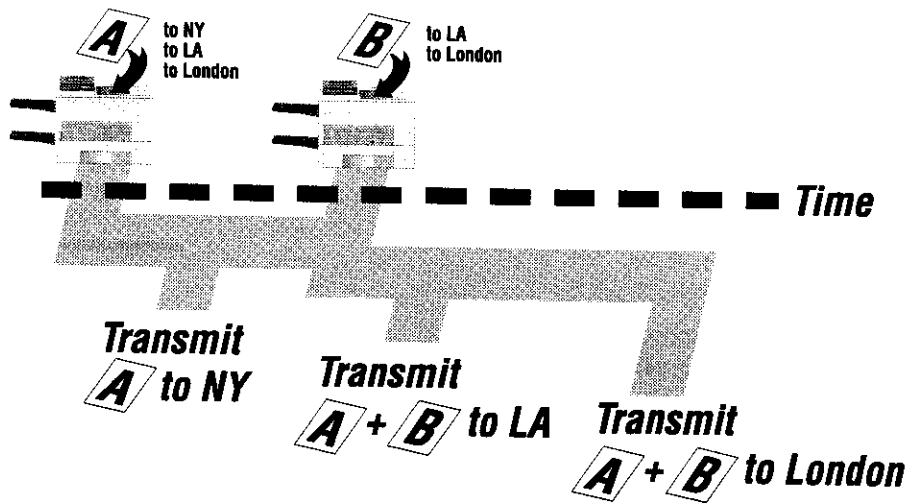

5

Delayed Batch Transmission

Assign a time for batch transmission to a Program Key in advance. All transmission(s) using the Program Key are batched and transmitted at the reserved time.

The following is an example to show Delayed Batch Transmission.

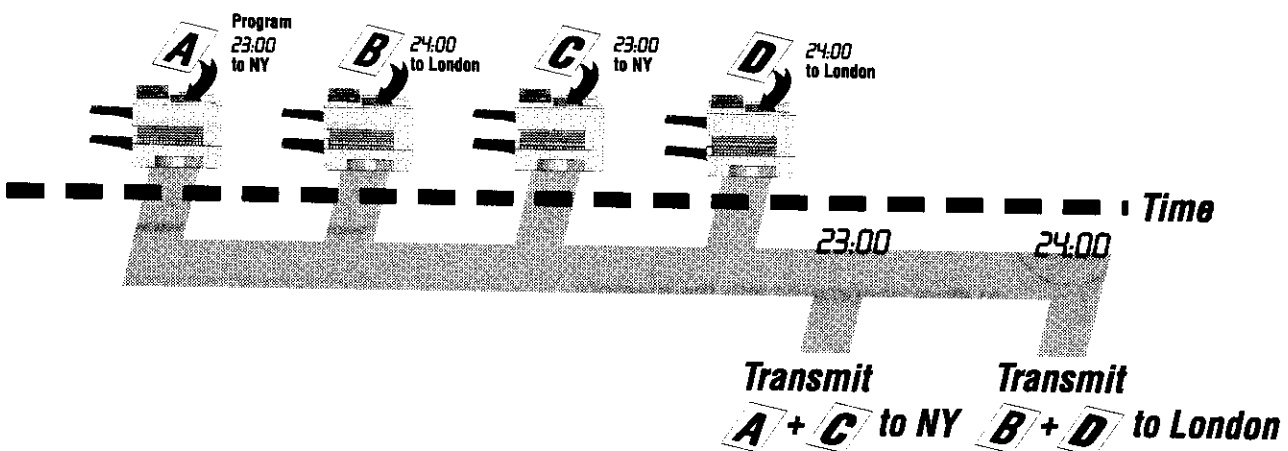

! Note:

1. The machine can not Batch to a file(s) that is/are Waiting to Redial or currently being sent, but it will Batch to files that are pending to dial.

▶ Timer Controlled Communications

You can send a document to one or multiple stations at any preset time within the next 24 hours. Up to 70* built-in timers can be set for deferred transmission and deferred polling. (* UF-885 : 30 built-in timers)

Deferred Transmission

1



Set document(s) face down.

ENTER STATION(S)
THEN PRESS START 00%

2



DEFERRED COMM. (1-2)
ENTER NO. OR ∨ ^

3

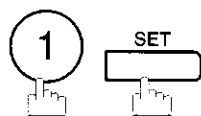

DEFERRED XMT
START TIME ■ :

4

Enter the start time from the keypad.
(Use a 4-digit, 24-hour clock)

Ex: ② ③ ③ ① (11:30 p.m.) and

ENTER STATION(S)
THEN PRESS START

5

Dial by any combination of the following methods:

- One-Touch Dialling
- Abbreviated Dialling
- Manual Number Dialling, press after each station is entered
(UF-895: Up to 70 stations, UF-885: Up to 30 stations)
- Directory Search Dialling, press after each station is entered
(For details, see page 46 to 49.)

Ex:

<01>(Station name)
5551234

6

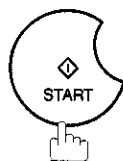

to store documents into the memory.

* STORE * NO.002
PAGES=001 05%

* STORE * COMPLETED
TOTAL PAGES=005 30%

! Note:

1. If you enter a wrong number in Step 4, press then re-enter the right number.
2. To change or cancel the Deferred Communication settings, see page 79 and 81.
3. When you reserve a deferred transmission without storing document into memory, the following message will be shown on the display after pressing in the last step.

DEF DIRECT XMT RSV'D
<01>(Station name)

Timer Controlled Communications

Deferred Polling

1

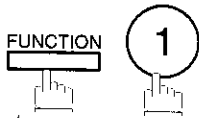

DEFERRED COMM. (1-2)
ENTER NO. OR V ^

2

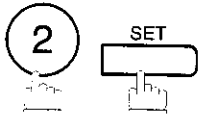

DEFERRED POLLING
START TIME ■ :

3

Enter the start time from the keypad.
(Use a 4-digit, 24-hour clock)

Ex: (0)(3)(3)(0) (3:30 a.m.) and

DEFERRED POLLING
PASSWORD=■■■■

4

Enter a 4-digit polling password.

Ex: (9)(8)(7)(6) and

ENTER STATION(S)
THEN PRESS START

5

Dial by any combination of the following methods:

- One-Touch Dialling
- Abbreviated Dialling
- Manual Number Dialling, press after each station is entered
(UF-895: Up to 70 stations, UF-885: Up to 30 stations)
- Directory Search Dialling, press after each station is entered
(For details, see page 46 to 49.)

Ex:

<01>(Station name)
5551234

6

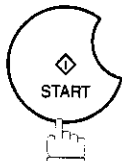

* STORE * NO.001

! Note:

1. If you enter a wrong number in Step 3, press , then re-enter the right number.
2. To change or cancel the Deferred Communication settings, see page 79 and 81.

5

▶ Polling

Polling means calling other station(s) to retrieve a document. The other station must know in advance that you will call and must have a document set on the ADF or stored in the memory. You may need to set a polling password, shared by the other station, to ensure security.

Setting the Polling Password

If the polling password does not match with the polled station, your polling request will be refused automatically.



To set the polling password, follow the steps below.

1   

2   

3    

4 Enter a 4-digit polling password.
Ex:     

5  



Note:

1. Polling might not function with all fax machines. We suggest you attempt a trial polling before you actually poll important documents.
2. If a password is not set in the polled station, you may poll the other station even though your machine has a password.

Preparing to be Polled

In order to let other stations poll your machine, you must prepare your machine with a document stored in memory. Be sure to set the polling password before storing the document into memory. After being polled, the documents stored in the memory will be erased automatically. To retain the documents in memory so that they can be polled repeatedly change Fax Parameter No. 27 (POLLED FILE SAVE) to "Valid".

1



Set document(s) face down.

```
ENTER STATION(S)
THEN PRESS START 00%
```

5

2

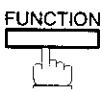

```
POLLING      NO.=■
1: POLLING  2: POLLED
```

3



```
POLLED
PASSWORD=1234
```

4

Enter a 4-digit polling password. (See Note 3)

Ex: ④ ③ ② ①

```
POLLED
PASSWORD=4321
```

5

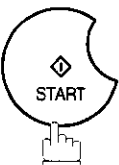

The document(s) will be stored into memory.

```
* STORE *      NO.015
      PAGES=001  01%
```

```
* STORE * COMPLETED
TOTAL PAGES=005  24%
```













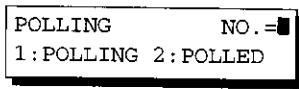

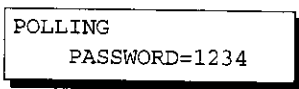
! Note:

1. You can still send or receive documents even when set to be polled.
2. Only 1 polled file can be stored in memory. If you need to add document(s) into the same polled file, see page 83.
3. If you have set the polling password in Fax Parameter No. 26, the password will appear on the display. You can still change the password temporarily by overwriting it with a new one.

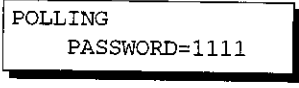
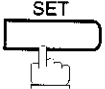
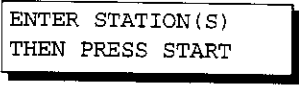
▶ Polling

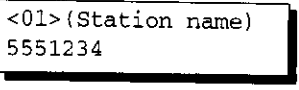
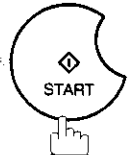

To Poll Documents from Another Station

The following procedure lets you poll a document from one or multiple stations. Be sure to set the polling password before polling. (See page 68)

- 1**   
- 2**  
- 3** Enter a 4-digit polling password. (See Note 2)
Ex:     
- 4**  
- 5** Dial by any combination of the following methods:
 - One-Touch Dialling
 - Abbreviated Dialling
 - Manual Number Dialling, press  after each station is entered
(UF-895: Up to 70 stations, UF-885: Up to 30 stations)
 - Directory Search Dialling, press  after each station is entered
(For details, see page 46 to 49.)Ex:  
- 6**  



Note:

1. You can review the entered stations in step 5 by pressing  or  key, press  to erase the displayed station or group as needed.
2. If you have set the polling password in Fax Parameter No. 26, the password will appear on the display. You can still change the password temporarily by overwriting it with a new one.

Program Keys ◀

Your fax machine has special Program Keys. These keys are useful if you frequently need to send or poll the same group of stations. You can use these keys to store a One-Touch group key, a sequence of stations to be polled, a deferred transmission or polling sequence or an additional One-Touch key.

Setting for Group Dialling

To set a Program Key for Group Dialling

1

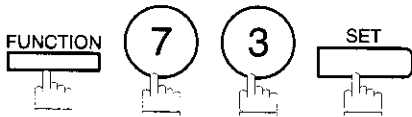

```
PROGRAM      (1-4)
ENTER NO. OR v ^
```

2

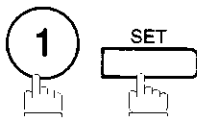

```
PROGRAM[P ]
PRESS PROGRAM KEY
```

3

Ex:

```
PROGRAM[P1]   NAME
ENTER NAME
```

4

Enter the station name (up to 15 characters) by using the Character keys. (See page 12)

Ex: PROG.A and

```
ENTER STATION(S)
THEN PRESS START
```

5

Enter the station numbers by using One-Touch Key or and 3-digit code.

Ex: and

You may use the ▼ or ▲ keys to review the entered station(s) before going to next step. If you find an error, press to erase the displayed station.

```
<01>(Station name)
5551234
```

```
[010](Station name)
5553456
```

6

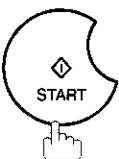

You can now set other Program Keys by repeating the procedures from Step 3, or return to standby by pressing

.

```
PROGRAM[P ]
PRESS PROGRAM KEY
```

5

▶ Program Keys

Setting for Deferred Transmission

To set a Program Key for deferred transmission

1

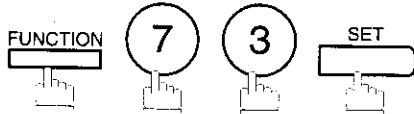

PROGRAM (1-4)
ENTER NO. OR ∨ ^

2

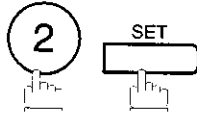

PROGRAM[P]
PRESS PROGRAM KEY

3

Ex: P1

PROGRAM[P1] NAME
ENTER NAME

4

Enter the station name (up to 15 characters) by using the Character keys. (See page 12)

Ex: PROG.A and SET

PROGRAM[P1]
PRESS FUNCTION KEY

5

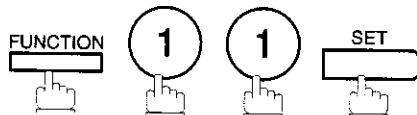

DEFERRED XMT
START TIME ■ :

6

Enter the starting time using 4 digits.

Ex: ② ③ ③ ① (11:30 p.m.) and SET

ENTER STATION(S)
THEN PRESS START

7

Enter the station by any combination of the following methods:

- One-Touch Dialling
- Abbreviated Dialling
- Directory Search Dialling, press SET after each station is entered

(For details, see page 47 to 49.)

Ex: 01

<01>(Station name)
5551234

8

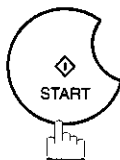

PROGRAM[P]
PRESS PROGRAM KEY

You can now set other Program Keys by repeating the procedures from Step 3, or return to standby by pressing

STOP.

Program Keys

Setting for Deferred Polling

To set a Program Key for deferred polling

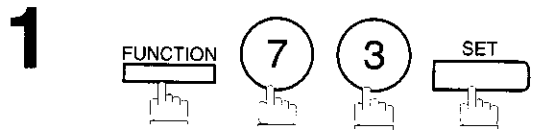

PROGRAM (1-4)
ENTER NO. OR V ^

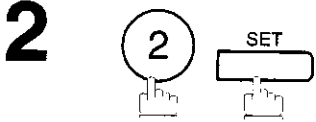

PROGRAM[P]
PRESS PROGRAM KEY

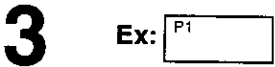

PROGRAM[P1] NAME
ENTER NAME

4 Enter the station name (up to 15 characters) by using the Character keys. (See page 12)

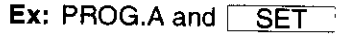

PROGRAM[P1]
PRESS FUNCTION KEY

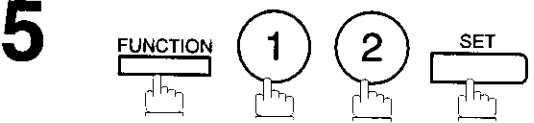

DEFERRED POLLING
START TIME ■ :

6 Enter the starting time.

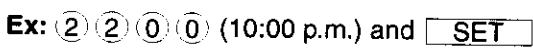

DEFERRED POLLING
PASSWORD=■■■■

7 Enter a 4-digit polling password.

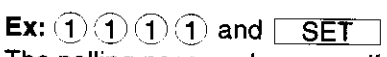

ENTER STATION(S)
THEN PRESS START

8 Enter the station by any combination of the following methods:

- One-Touch Dialling
- Abbreviated Dialling
- Directory Search Dialling, press SET after each station is entered
(For details, see page 47 to 49.)

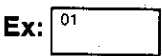

<01>(Station name)
5551234

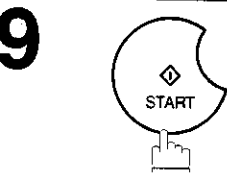

PROGRAM[P]
PRESS PROGRAM KEY

You can now set other Program Keys by repeating the procedures from Step 3, or return to standby by pressing



5

▶ Program Keys

Setting for Normal Polling

To set a Program Key for normal polling

1

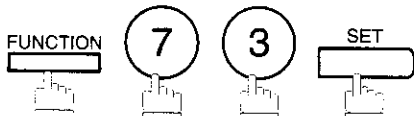

```
PROGRAM          (1-4)
ENTER NO. OR V ^
```

2

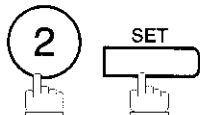

```
PROGRAM[P ]
PRESS PROGRAM KEY
```

3

Ex: P1

```
PROGRAM[P1]     NAME
ENTER NAME
```

4

Enter the station name (up to 15 characters) by using the Character keys. (See page 12)

Ex: PROG.A and SET

```
PROGRAM[P1]
PRESS FUNCTION KEY
```

5

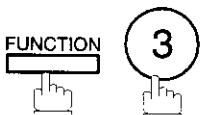

```
POLLING
PASSWORD=■■■■
```

6

Enter a 4-digit polling password.

Ex: 1 1 1 1 and SET

```
ENTER STATION(S)
THEN PRESS START
```

The polling password appears if it has been previously set.

7

Enter the station by any combination of the following methods:

- One-Touch Dialling
- Abbreviated Dialling
- Directory Search Dialling, press SET after each station is entered
(For details, see page 47 to 49.)

Ex: 01

```
<01>(Station name)
5551234
```

8

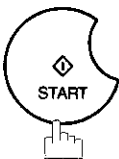

```
PROGRAM[P ]
PRESS PROGRAM KEY
```

You can now set other Program Keys by repeating the procedures from Step 3, or return to standby by pressing

STOP.

Program Keys

Setting for One-Touch Key

To set a Program Key for One-Touch Key

1

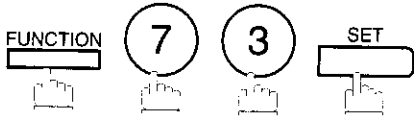

PROGRAM (1-4)
ENTER NO. OR v ^

2

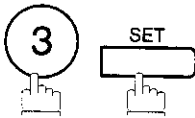

PROGRAM[P]
PRESS PROGRAM KEY

3

Ex: P1

PROGRAM[P1] NAME
ENTER NAME

4

Enter the station name (up to 15 characters) by using the Character keys. (See page 12)

Ex: PROG.A and SET

[P1] PROG.A
ENTER TEL. NO.

5

Enter a telephone number (up to 36 digits including pauses and spaces).

Ex: 9 PAUSE 5 5 5 SPACE 1 2 3 4

[P1] PROG. A
9-555 1234

6

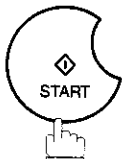

You can now set other Program Keys by repeating the procedures from Step 3, or return to standby by pressing

STOP.

5

▶ Program Keys

Changing or Erasing the Program Key Settings

To change the settings in a Program Key, follow the procedure on setting a Program Key on pages 71 to 75.

- Start time or station(s) for deferred transmission
- Station(s) for normal polling
- Start time or station(s) for deferred polling
- Station(s) for group dialling
- Telephone number and station name for One-Touch key

To erase the settings in a Program Key

1

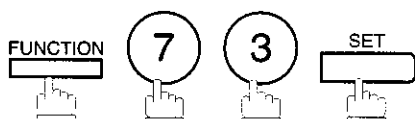

```
PROGRAM          (1-4)
ENTER NO. OR v ^
```

2

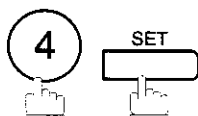

```
PROGRAM[P ]
PRESS PROGRAM KEY
```

3

Press the Program key you want to erase.

Ex:

```
PROGRAM[P1]
DELETE? 1:YES 2:NO.
```

4



```
* DELETING *
PROGRAM[P1]
```

5

You can now erase other Program Keys by repeating the procedures from Step 3, or return to standby by pressing

.

```
PROGRAM[P ]
PRESS PROGRAM KEY
```

Edit File Mode ◀

Your machine has a document image memory which enables you to reserve memory transmission, memory deferred transmission, memory polling and so on. After reserving the communications in memory, you may need to change the settings of the communication(s) while it is still in memory. This section describes how to use the file editing features.

Printing a File List

The contents of the communication settings may have to be modified or deleted. To verify the contents, follow the steps below to print out a file list.

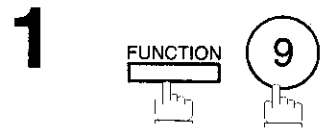

```
EDIT FILE MODE (1-6)
ENTER NO. OR v ^
```

5

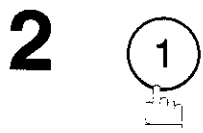

```
1:FILE LIST?
PRESS SET TO SELECT
```

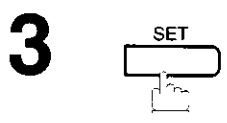

```
FILE LIST
1:PRINT 2:VIEW
```

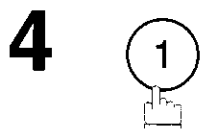

```
* PRINTING *
FILE LIST
```

Sample File List

```
***** -FILE LIST- ***** DATE 12-JAN-1999 ***** TIME 15:00 *****
```

(1)	(2)	(3)	(4)	(5)	(6)
FILE No.	COMM. TYPE	CREATED TIME	START TIME	PAGES	DESTINATION(S)
001	DEFERRED XMT	12-JAN 13:20	20:30		[001]
002	MEM. DEF. XMT	12-JAN 13:20	22:30	003	[011] [012] [013] [016] [017]
					-PANASONIC
		***** -HEAD OFFICE		***** - 201 555 1212- *****	

Explanation of Contents

- (1) File number : If the file is now being executed, a "*" is indicated on the left of the file number.
- (2) Communication type
- (3) Stored date/time : Date/time that these files were stored.
- (4) Executing time : If the file is a Timer Controlled Communication, the start time is printed in this column.
If the file is an incomplete file, "INCOMP" is printed in this column.
- (5) Number of stored page(s)
- (6) Destination : ABBR. No./One-Touch No./Manual Dialling No.

▶ Edit File Mode

Viewing the Contents of a File List



To view the contents of a file list on the display without printing it, follow the steps below.

1   EDIT FILE MODE (1-6)
ENTER NO. OR v ^

2  1:FILE LIST?
PRESS SET TO SELECT

3  FILE LIST
1:PRINT 2:VIEW

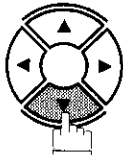
4  USE THE v ^ KEYS TO
SCROLL EACH FILE

5  or  repeatedly until the display shows a file you want to edit.

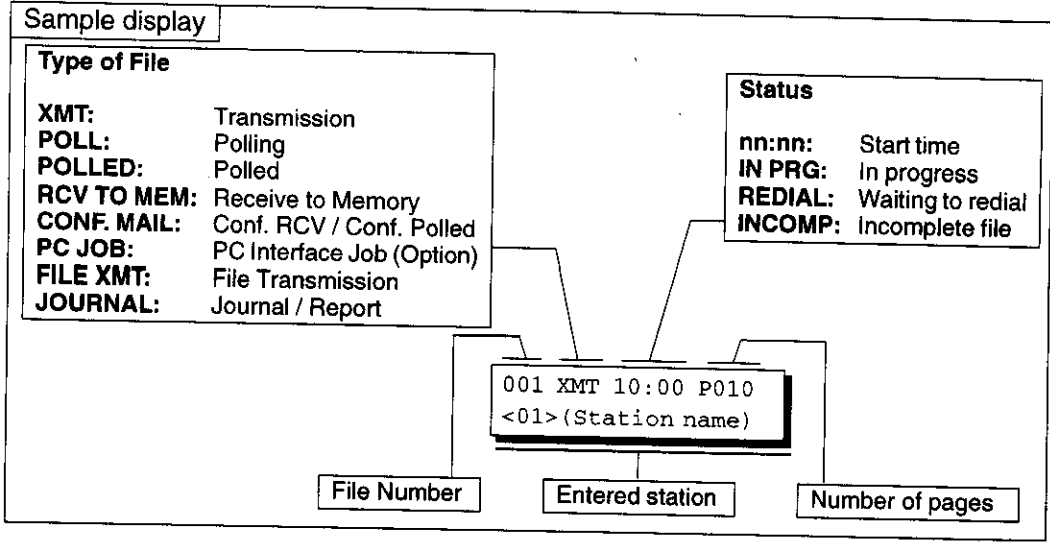

6 

Edit File Mode ◀

Changing the Start Time or the Station of a File

To change the start time and/or stations in a communication file, follow the steps below.

1

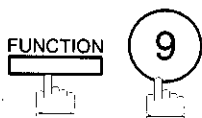

```
EDIT FILE MODE (1-6)
ENTER NO. OR v ^
```

2



```
ENTER FILE NO. OR v ^
FILE NO. =■■■
```

3

Enter the file number or use ▼ or ▲ to select the file that you want to change.

Ex: 0 0 1

```
ENTER FILE NO. OR v ^
FILE NO. =001
```

4

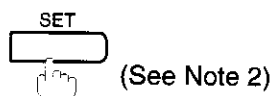

```
DEFERRED XMT
START TIME 22:30
```

5

Enter a new start time.

Ex: 0 6 0 0 (6:00 a.m.)
(If you do not have to change the time, skip to step 6.)

```
DEFERRED XMT
START TIME 06:00
```

6

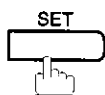

```
TEL. NO.
5551234
```

5

▶ Edit File Mode

7 To delete the station(s), press or key until the station you want to delete appears. Then press .

ENTER STATION(S)
THEN PRESS START

or

Enter the station(s) you want to add.

Ex:

1 STN(S) ARE SET
ADD MORE OR START

8

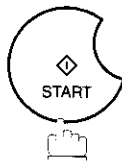

! **Note:**

1. Your machine cannot change the start time and/or stations in the file while it is being sent or waiting to redial.
2. If the file is not a Deferred Communication File, the following message is shown on the display.

SET DEFERRED COMM. ?
1: YES 2: NO

Press to change the type of the file for deferred communication file.

3. If you edit the file that is saved as an incomplete file, after pressing in step 8, your machine will prompt you whether to execute the file immediately.

The display shows:

RETRY INCOMP. FILE?
1: YES 2: NO

Press to execute the file immediately.

Deleting a File

To delete the file in memory, follow the steps below.

1

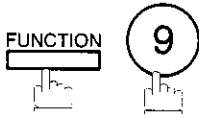

```
EDIT FILE MODE (1-6)
ENTER NO. OR V ^
```

2

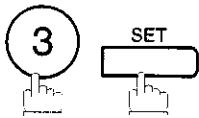

```
ENTER FILE NO. OR V ^
FILE NO.=■■■
```

3

Enter the file number or use ▼ or ▲ to select the file that you want to delete.

```
ENTER FILE NO. OR V ^
FILE NO.=001
```

Ex: 0 0 1 (See Note 2)

4

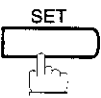

```
DELETE FILE NO.001?
1:YES 2:NO
```

5

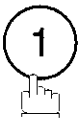

Enter the next file number you want to delete or press **STOP** to return to standby.

```
* DELETING *
FILE NO.=001
```

```
ENTER FILE NO. OR V ^
FILE NO.=■■■
```

! Note:

1. Your machine cannot delete the file while it is being sent.
2. Enter * * * as the file number and press **SET** to delete all files (except the file in progress). The following message is shown on the display.

```
DELETE ALL FILES?
1:YES 2:NO
```

Press 1 to delete all files.

5

▶ Edit File Mode

Printing Out a File

To print the contents of the communication file, follow the steps below.

1

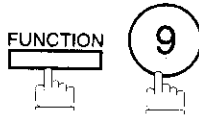

```
EDIT FILE MODE (1-6)
ENTER NO. OR v ^
```

2

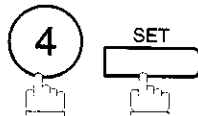

```
ENTER FILE NO. OR v ^
FILE NO. = ■■■
```

3

Enter the file number or use ▼ or ▲ to select the file that you want to print.

Ex: ① ① ①

```
ENTER FILE NO. OR v ^
FILE NO. =001
```

4

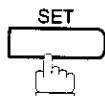

Your machine will print the file. The document(s) will remain in memory even after printing the file.

```
* PRINTING *
PAGE=001/003
```



Note:

1. Your machine cannot print the file while it is being sent.

Edit File Mode ◀

Adding Documents into a File

To add documents into the file, follow the steps below.

1



Set document(s) face down.

ENTER STATION(S)
THEN PRESS START 00%

2

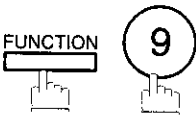

EDIT FILE MODE (1-6)
ENTER NO. OR ∨ ^

3

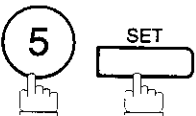

Enter the file number or use ▼ or ▲ to select the file that you want to add.

Ex: 0 0 1

ENTER FILE NO. OR ∨ ^
FILE NO. = ■■■

ENTER FILE NO. OR ∨ ^
FILE NO. =001

4

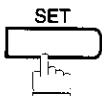

Your machine will start storing the document(s) into a file.

* STORE * NO.001
PAGES=001 10%

5



Note:

1. Your machine cannot add the document into the file while it is being sent or waiting to redial.

▶ Edit File Mode

Retry an Incomplete File

If a memory communication has been unsuccessful due to a busy line or no answer, the document you stored is automatically erased from memory after the last redial.

If you need to retain the document even if the communication failed, change the setting of Fax Parameter No. 31 (INC. FILE SAVE) to Valid in advance. (See page 36)

To retry the incomplete file, print a File List first to verify the file number. (See page 77)
Then, follow the steps below.

1

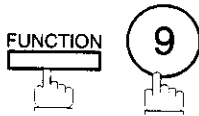

EDIT FILE MODE (1-6)
ENTER NO. OR ∨ ^

2

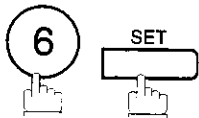

ENTER FILE NO. OR ∨ ^
FILE NO. =■■■

3

Enter the file number or use ▼ or ▲ to select the file that you want to retry.

Ex: 0 0 1

ENTER FILE NO. OR ∨ ^
FILE NO. =001

4

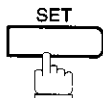

Your machine will retry the file and start dialling immediately.

* STORE * NO.001

* DIALLING * NO.001
(Station name)



Note:

1. To confirm or change the entered telephone number for the file, see page 77 and 79.
2. If you set Fax Parameter No.31 to Valid, all incomplete files will remain in the memory. To avoid memory overflow, please check the memory content frequently. We recommend that optional flash memory card is installed when this function is used. (See page 171)

Access Code

The Access Code prevents an unauthorized user from operating the machine. Once a 4-digit Access Code is registered, no one can operate the machine without entering the correct access code.

Automatic Receiving, however, is always available. After you complete any operation, such as mode setting or transmission, and the display returns to standby, you have to re-enter the access code in order to use the machine again. Registering the Access Code does not affect the use of the machine in any other way.

Setting the Access Code

1

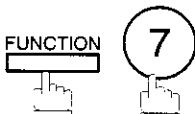

SET MODE (1-6)
ENTER NO. OR V ^

5

2

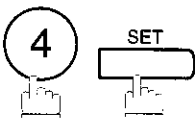

FAX PARAMETER(01-99)
NO.=■

3

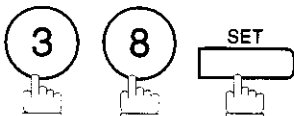

38 ACCESS CODE
■■■■

4

Enter a 4-digit Access Code.

38 ACCESS CODE
1234

Ex: ①②③④

5



38 ACCESS CODE
1:ALL 1234

6

Select Restriction Level.

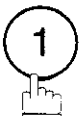

for All operations

or



for Setting and Printing the Fax Parameters only.

38 ACCESS CODE
2:FAX PARA. 1234

Ex: ②

7

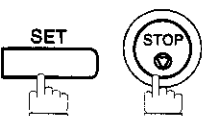

! Note:

- To erase the Access Code, enter the Access Code and press **SET** and follow the procedure above to step 3, then press **CLEAR** **SET** and **STOP**.

▶ Access Code

Operating Your Machine with the Access Code (Restrict all operations)

1 Enter the Access Code.

Ex: ①②③④

12-JAN-1999 15:00
ACCESS CODE=■

12-JAN-1999 15:00
ACCESS CODE=■■■■

2

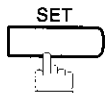

Now you can operate the machine normally.

12-JAN-1999 15:00
00%

Operating Your Machine with the Access Code (Restrict access of Fax Parameters only)

The UF-885/895 can restrict the operation of setting and printing the Fax Parameters only.

Ex: When setting the Fax Parameter.

1

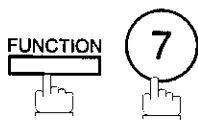

SET MODE (1-6)
ENTER NO. OR v ^

2

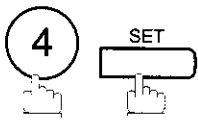

INPUT ACCESS CODE
■

3

Enter a 4-digit Access Code.

Ex: ①②③④

INPUT ACCESS CODE
1234

4





Now you can operate the machine normally.

FAX PARAMETER(01-99)
NO.=■

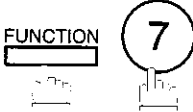
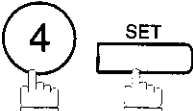

Receive To Memory ◀

This feature is used to secure all received documents by storing them into the memory. To print out the document from memory, the authorized operator must enter the correct password.

Setting the RCV To Memory Password

1		SET MODE (1-6) ENTER NO. OR ∨ ^	
2		FAX PARAMETER(01-99) NO.=■	5
3		37 RCV TO MEMORY ■■■■	
4	Enter a 4-digit RCV to Memory Password. Ex: ① ② ③ ④		
5		37 RCV TO MEMORY 1234	

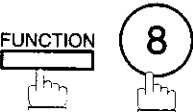
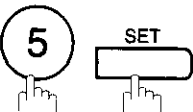
Setting RCV To Memory

1		SELECT MODE (1-5) ENTER NO. OR ∨ ^
2		RCV TO MEMORY=OFF 1:OFF 2:ON 3:PRINT
3		RCV TO MEMORY=ON 1:OFF 2:ON 3:PRINT
4		12-JAN-1999 15:00 < RCV TO MEMORY >



Note:

1. When the memory overflows, the machine will stop receiving and release the line. The machine will not answer the next incoming call until there is space available in the memory.
2. We recommend that optional flash memory card is installed when this function is used. See page 168 on Image Memory Capacity.

Receive To Memory

Printing Out Documents

After receiving a document with the Receive To Memory feature, the following message will appear on the display.

To print the document, follow the steps below.

1

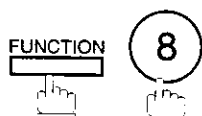

MESSAGE IN MEMORY
< RCV TO MEMORY >

2



SELECT MODE (1-5)
ENTER NO. OR v ^

3



RCV TO MEMORY=ON
1:OFF 2:ON 3:PRINT

4

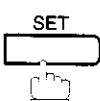

RCV TO MEMORY=PRINT
1:OFF 2:ON 3:PRINT

5

Enter the password to print the documents.
(See Note 1)

INPUT PASSWORD

Ex: ① ② ③ ④

INPUT PASSWORD 1234

6



* PRINTING *
MEMORY RCV'D DOC

Machine will start to print the documents.

! Note:

1. If the password has not been set, your machine will not prompt you to enter the password. The documents will be printed immediately after pressing **SET** in step 4.
2. Once the RCV TO MEMORY feature is set to "On", the password cannot be changed (Fax Parameter No. 37 will not be shown on the LCD display). If you wish to change the password, set RCV TO MEMORY feature to "Off" first. Then change the password. (See page 87)

Distinctive Ring Detector (DRD) ◀

This function is only effective for companies in countries which offer the DRD Service.

Your machine has a special feature in conjunction with an optional service provided by many local telephone companies. It can distinguish up to 2 telephone numbers with a corresponding ring pattern identifying each number. "DRD" lets you provide multiple phone numbers, one for your fax, business or personal use with only one single phone line.

Please check with your local telephone company on the availability of this service in your area.

Your machine can be programmed to respond to the specified ring pattern only for the DRD Service. To enable your machine to detect the ring pattern only for fax communication, change the setting of Fax Parameter No. 30 (see page 36).

5

The following table shows a typical example with 2 telephone numbers on a single phone line.

Telephone No.	Usage	Distinctive Ring Sound	Ring Pattern
555-1111	Phone	<i>Riiing.....Riiing.....</i>	Standard Ring
555-2222	Fax	<i>Ring...Ring.....Ring...Ring.....</i>	Double Ring

The following illustration shows a typical set up, with your machine set to detect "double ring" pattern.

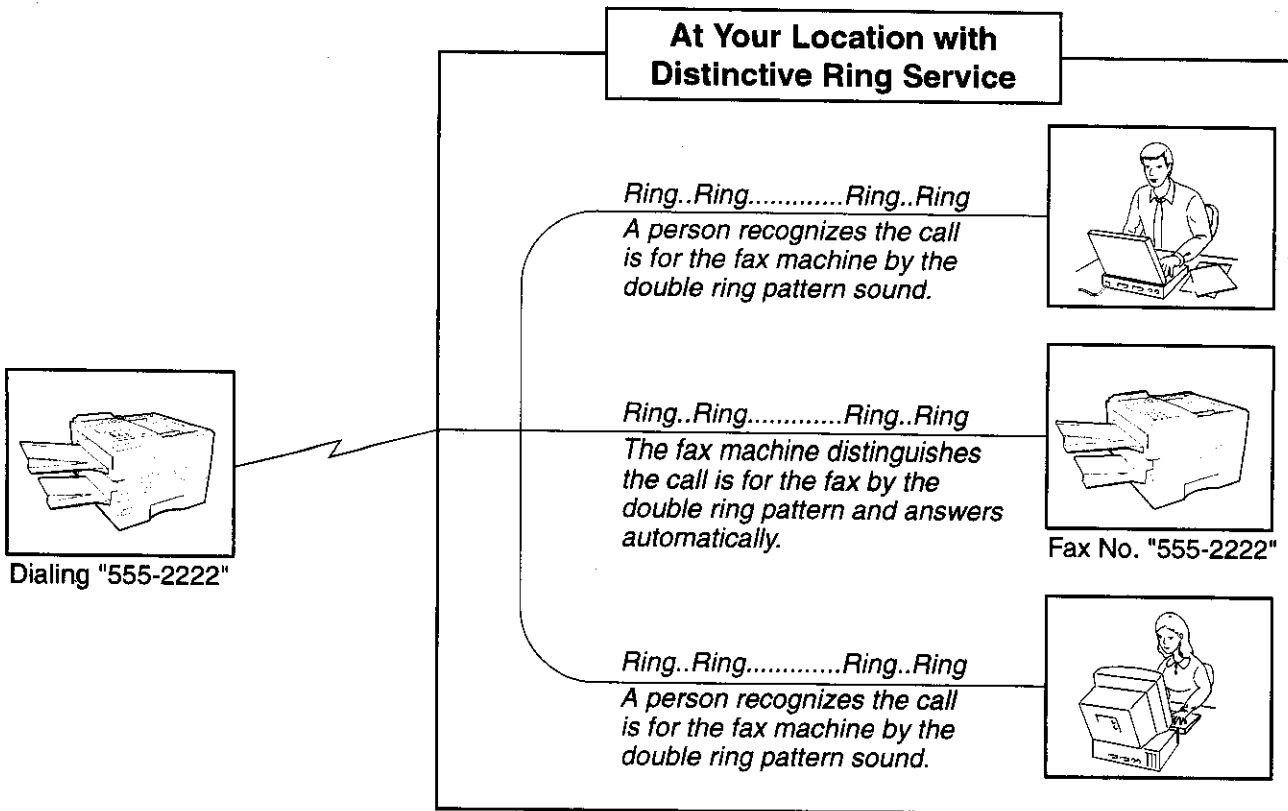

! **Note:** 1. "Riiing" means a long ringing sound and "Ring" means a short ringing sound.

▶ Fax Cover Sheet

General Description

A Fax Cover Sheet can be automatically attached to your transmit document(s) that shows the recipient's name, originator's name and the number of pages attached.

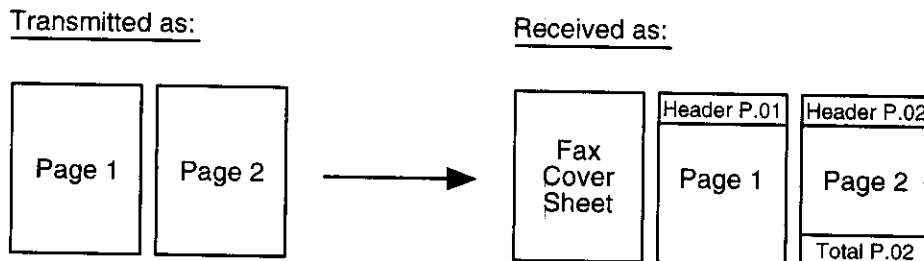

To use the Fax Cover Sheet

To attach a Fax Cover Sheet to a transmission, follow the procedure below.

1



Set document(s) face down.

ENTER STATION(S)
THEN PRESS START 00%

2

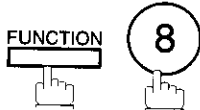

SELECT MODE (1-5)
ENTER NO. OR ∨ ^

3

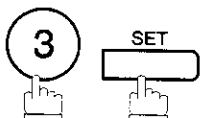

COVER SHEET=OFF
1:OFF 2:ON

4

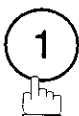

for "OFF" (Cover Sheet is not attached)

COVER SHEET=OFF
1:OFF 2:ON

or



for "ON" (Cover Sheet is attached)

COVER SHEET=ON
1:OFF 2:ON

or

5

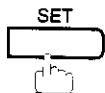

ENTER STATION(S)
THEN PRESS START 00%

6

Dial the station(s) you wish to send the documents to.

Ex:

! **Note:**

1. To change the preset Fax Cover Sheet Setting, change the setting of Fax Parameter No. 56, see page 37.
2. This function is available for memory or direct transmission modes.
3. The Fax Cover Sheet is not counted in the number of pages column of the journals.

Fax Cover Sheet Sample

***** FACSIMILE COVER SHEET *****

(1)

12-JAN-1999 15:00

12-

(2)

Message To:

SALES DEPT.

(3)

Message From:

PANASONIC
201 555 1212

(4)

02

Page(s)

Following This Cover Page

5

Explanation of contents

- (1) Starting time of communication.
- (2) Recorded name in the One-Touch, ABBR. No. or dialed telephone number.
- (3) Your LOGO (up to 25 characters) and ID Number. (Up to 20 digits)
- (4) The number of pages to follow. This information is not shown when transmitting by Direct Transmission Mode.

Fax Forward

Setting Fax Forward

This feature allows all incoming faxes to be forwarded to the station registered in the one-touch or abbreviated dialling number. Once the faxes are received in the memory, the machine will forward the received document(s) to the telephone number registered in the one-touch or abbreviated dialling number.

This function is convenient when you would like to receive faxes in another place (i. e. your home) at night or during a holiday.

1

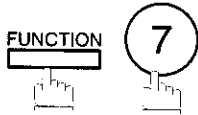

SET MODE (1-6)
ENTER NO. OR v ^

2

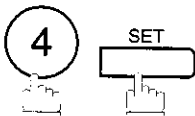

FAX PARAMETER (01-99)
NO. =■

3

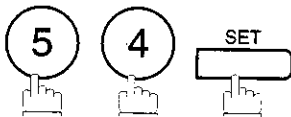

54 FAX FORWARD
1: INVALID

4



54 FAX FORWARD
2: VALID

5



54 FAX FORWARD
ENTER STATION

6

Enter the station to forward the received faxes to, by assigning a one-touch key or an abbreviated dialling number.

Ex: 01

<01> (STATION NAME)
5551234

7

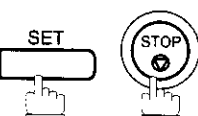

Note:

1. If the communication to transfer a received document(s) fails, the received document will print out and then is erased from memory even if the Fax Parameter No. 31 (INC. FILE SAVE) is set to "Valid".
If you wish to save the document into memory in case of communication failure, set your machine to Receive To Memory. (See page 87)
2. It is not possible to receive a document if the memory of your machine overflows or is about 95% used.

File Transmission ◀

This feature allows your machine to store the document(s) into the File Transmission in order to send to a single or to multiple locations when desired. The document(s) in the File Transmission will be kept until it is manually deleted.

Storing the Document(s)

To store the document(s), follow the steps below.

1



Set document(s) face down.

ENTER STATION(S)
THEN PRESS START 00%

5

2

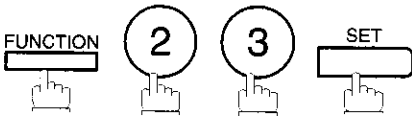

FILE XMT MODE (1-4)
ENTER NO. OR ∨ ^

3



1: STORE FILE?
PRESS SET TO SELECT

4



Your machine will start storing the document(s) into the memory.

* STORE * NO.001
PAGES=001 01%

! **Note:** 1. Only 1 file can be stored for File Transmission.

File Transmission

Sending the Stored Document(s)

To send the stored document(s), follow the steps below.

1

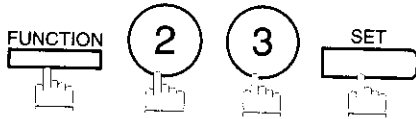

FILE XMT MODE (1-4)
ENTER NO. OR V ^

2

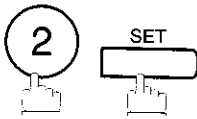

ENTER STATION(S)
THEN PRESS START

3

Dial by any combination of the following methods:

- One-Touch Dialling
- Abbreviated Dialling
- Manual Number Dialling, press **SET** after each station is entered
(UF-895: Up to 70 stations, UF-885: Up to 32 stations)
- Directory Search Dialling, press **SET** after each station is entered
(For details, see page 46 to 49.)

Ex:

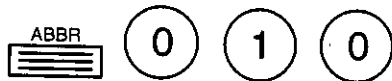

If you want to confirm the number of stations you have entered, press **SET**.

<01>(Station name)
5551234

[010](Station name)
5553456

4

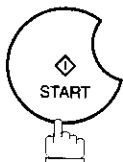

Your machine starts dialling the telephone numbers in sequence.

* DIALLING * NO.001
(Station name)

File Transmission ◀

Deleting the Stored Document(s)

To delete the stored document(s), follow the steps below.

1

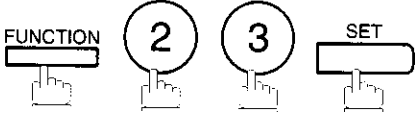

FILE XMT MODE (1-4)
ENTER NO. OR ∨ ^

2



3:DELETE FILE?
PRESS SET TO SELECT

3



* DELETING *

5

File Transmission

Printing the Stored Document(s)

To print the stored document(s), follow the steps below.

1

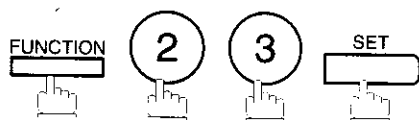

FILE XMT MODE (1-4)
ENTER NO. OR v ^

2



4:PRINT FILE?
PRESS SET TO SELECT

3

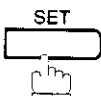

* PRINTING *
FILE XMT DOC

Your machine will print the file. The document(s) will remain in the memory even after printing the file.

Department Code ◀

General Description

This operation requires the user to input a preset 4-digit Department Code before transmission. The Department Name of the selected Department Code is printed on the Header of each page sent, Cover Sheet, COMM. Journal and Individual Transmission Journal. When the Department Code is set, the Transaction Journal will be sorted by the Department Code number (01 - 24) when it is printed. If you wish to prevent unauthorized persons from setting, changing or erasing the Department Code settings, you should set the Access Code to restrict these settings. (See page 85)

Setting the Department Code

5

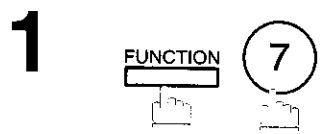

```
SET MODE      (1-6)
ENTER NO. OR ∨ ^
```

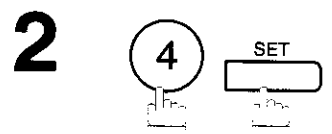

```
FAX PARAMETER (01-99)
NO. = ■
```

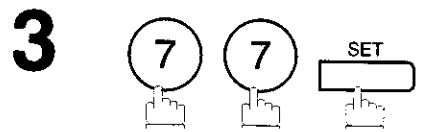

```
77 LOGO/DEPT. CODE
1: INVALID
```

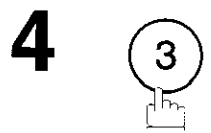

```
77 LOGO/DEPT. CODE
3: DEPT. CODE
```

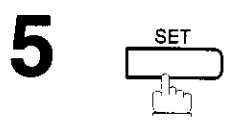

```
DEPT. CODE (01-24)
ENTER NO. OR ∨ ^
```

6 Enter Department Code number.
Ex: ① ② (01 to 24)

```
LOGO/DEPT. NAME
12 ■
```

▶ Department Code

7 Enter your Department Name (max. 25 characters and digits) by using Character keys. (See page 12)

Ex: **P** **A** **N** **A** **S** **O** **N** **I** **C** **SPACE**
S **A** **L** **E** **S** (See Note 1)

LOGO/DEPT. NAME
12 PANASONIC SALES ■

8



INPUT DEPT. CODE
■■■■

9

Enter a 4-digit Department Code.

Ex: ① ② ③ ④

INPUT DEPT. CODE
1234

10

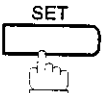

LOGO/DEPT. NAME
13 ■

To record another Department Code, repeat step 6 to 10.

To return to standby, press **STOP**.



Note:

1. Use **COPY** to copy the default LOGO which is set in the User Parameters. You can add the department name following the default LOGO.
2. When enabling the Dept. Code feature for the first time, it is important to Print the Journal by pressing **FUNCTION**, ⑥, ①, **SET** and ① in order to erase the previous journal contents.

Department Code ◀

Changing or Erasing the Department Code

If you have to change or erase any of the Department Codes, follow the steps below.

1

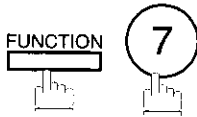

SET MODE (1-6)
ENTER NO. OR ∨ ^

2



INPUT ACCESS CODE
■■■■

3

If you set the Access Code to restrict the Fax Parameters settings, the unit prompts you to Input the Access Code. Input the Access Code and press **SET**.

FAX PARAMETER (01-99)
NO. =■

4



77 LOGO/DEPT. CODE
3:DEPT. CODE

5

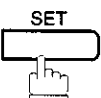

DEPT. CODE (01-24)
ENTER NO. OR ∨ ^

6

Enter the Department Code number you wish to change or erase.

LOGO/DEPT. NAME
12 PANASONIC SALES

Ex: ① ② (01 to 24)

5

▶ Department Code

7

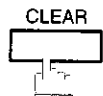

then enter a new LOGO. (See Note 1 and 2)

Ex: P A N A F A X SPACE
S A L E S

or just go to step 10 to erase the Department Code.

LOGO/DEPT. NAME
12 ■

LOGO/DEPT. NAME
12 PANAFAX SALES■

8



INPUT DEPT. CODE
1234

9

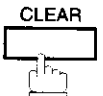

Then enter a new Department Code.

Ex: 5 6 7 8

INPUT DEPT. CODE
■■■■

INPUT DEPT. CODE
5678

10

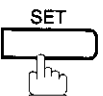

To change or erase another Department Code, repeat step 6 to 10. To return to standby, press **STOP**.

LOGO/DEPT. NAME
13 ■

! Note:

1. If you make a mistake, use **◀ ▶** to move the cursor beyond the incorrect character, press **CLEAR** then re-enter the correct Department Name.
2. Use **COPY** to copy the default LOGO which is set in the User Parameters. You can add the department name following the default LOGO.

Department Code ◀

Sending Document with Department Code

1



Set document(s) face down.

ENTER STATION(S)
THEN PRESS START 00%

2

Dial by any combination of the following methods:

- One-Touch Dialling
- Abbreviated Dialling
- Manual Number Dialling, press after each station is entered (UF-895: Up to 70 stations, UF-885: Up to 32 stations)
- Directory Search Dialling, press after each station is entered (For details, see page 46 to 49.)

5

Ex:

<01>(Station name)
5551234

3

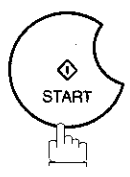

INPUT DEPT. CODE

4

Enter a 4-digit Department Code.

Ex: ① ② ③ ④

INPUT DEPT. CODE

5

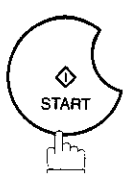

The document is sent with the header of the selected Department Name. The selected Department Name is printed on the COMM. Journal, Individual Transmission Journal and Cover Sheet.

▶ Department Code

Sending Document with Department Code (Voice Mode Transmission)

1



Set document(s) face down.

ENTER STATION(S)
THEN PRESS START 00%

2

Lift the optional handset or the external telephone or press **MONITOR**.

Ex: Press **MONITOR**

INPUT DEPT. CODE
■■■■

3

Enter a 4-digit Department Code.

Ex: (1) (2) (3) (4)

INPUT DEPT. CODE
1234

4

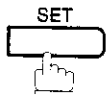

* MONITOR *
■

5

Dial the telephone number from the keypad.

Ex: (5) (5) (5) (1) (2) (3) (4)

* DIALLING *
5551234■

6

When you hear a beep,

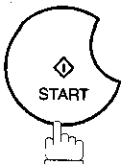

ON LINE * XMT *
5551234

The document is sent with the header of the selected Department Name. The selected Department Name is printed on the COMM. Journal, Individual Transmission Journal and Cover Sheet.

Department Code ◀

Printing a Department Code List

The Department Code List can be printed out following the Fax Parameter List.

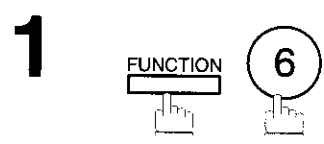

```
PRINT OUT      (1-7)
ENTER NO. OR  V ^
```

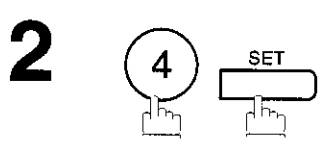

```
* PRINTING *
FAX PARAMETER LIST
```

5

Sample Department Code List (Prints following the Fax Parameter List)

```
***** -FAX PARAMETER LIST- ***** DATE 12-JAN-1999 ***** TIME 15:00 *** P.02
```

DEPARTMENT CODE LIST

(1) NUMBER	(2) DEPARTMENT NAME	(3) DEPARTMENT CODE
01	Panafax Sales	0001
02	Panafax Service	0002
03	Panafax Accounting	0003
}	}	}
24	Panafax Engineering	0024

-PANASONIC-

```
***** -HEAD OFFICE - ***** 201 555 1212 - *****
```

Explanation of contents

- (1) Department Code Number : 01-24
- (2) Department Name : Up to 25 characters
- (3) Department Code : 4 digits

▶ Department Code

Printing a Department Code Journal

When the Department Code is set, the Transaction Journal will be sorted by the Department Code number when it is printed. All contents of the Journal will be erased automatically after being printed.

1



PRINT OUT (1-7)
ENTER NO. OR v ^

2

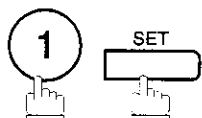

JOURNAL
1:PRINT 2:VIEW

3



* PRINTING *
JOURNAL

Sample Department Code Journal / Originated Calls

***** -JOURNAL- ***** DATE 12-JAN-1999 ***** TIME 15:00 *** P.01

ORIGINATED CALLS

10-JAN TO 12-JAN (1)

(2)

(3)

TOTAL PAGES = 000038 TOTAL TIME = 00:23:56

(4) (5)

01: Panafax Sales

NO.	COMM.	PAGES	FILE	DURATION	X/R	IDENTIFICATION	DATE	TIME	DIAGNOSTIC
01	OK	005		00:05:13	XMT	☎ 5551234	10-JAN	15:10	C0044903C0000
21	OK	021/021	019	00:10:15	FWD	FAX FORWARD	10-JAN	18:10	C0044903C0000

(6)

(7)

TOTAL PAGES = 000026 TOTAL TIME = 00:15:28

02: Panafax Service

NO.	COMM.	PAGES	FILE	DURATION	X/R	IDENTIFICATION	DATE	TIME	DIAGNOSTIC
19	OK	001/001	017	00:00:13	XMT	☎ 5551234	11-JAN	10:10	C0044903C0000
30	OK	011/011	045	00:08:15	XMT	SERVICE DEPT.	12-JAN	13:10	C0044903C0000

TOTAL PAGES = 000012 TOTAL TIME = 00:08:28

-PANASONIC

***** -HEAD OFFICE - ***** 201 555 1212 - *****

Sample Department Code Journal / Received Calls

```
***** -JOURNAL- ***** DATE 12-JAN-1999 ***** TIME 15:00 *** P.02

RECEIVED CALLS
10-JAN TO 12-JAN (1)
(2) (3)
TOTAL PAGES = 000011 TOTAL TIME = 00:13:41
```

NO.	COMM.	PAGES	FILE	DURATION	X/R	IDENTIFICATION	DATE	TIME	DIAGNOSTIC
55	OK	005		00:05:13	RCV	4445678	10-JAN	12:10	C0044903C0000
56	OK	005/005	020	00:08:15	PLD	111 222 333	10-JAN	19:15	C0044903C0000
70	OK	001	017	00:00:13	RCV	44567345	11-JAN	10:10	C0044903C0000

```
***** -PANASONIC -
***** -HEAD OFFICE - ***** 201 555 1212 - *****
```

5

Explanation of contents

- (1) Period date of this journal
- (2) Number of total pages transmitted/received for this machine.
- (3) Total transmitted/received time for this machine.
- (4) Department Code Number : 01-24
- (5) Department Name
- (6) Number of total pages transmitted/received for this department.
- (7) Total transmitted/received time for this department.

Multiple LOGO

General Description

This operation allows the user to select one of the 25 preset LOGOs before a transmission. The selected LOGO is printed on the Header of each page sent, Cover Sheet, COMM. Journal and Individual Transmission Journal.

Setting the Multiple LOGO

1



```
SET MODE      (1-6)
ENTER NO. OR v ^
```

2

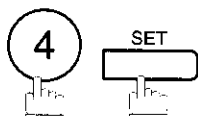

```
FAX PARAMETER(01-99)
NO. =■
```

3

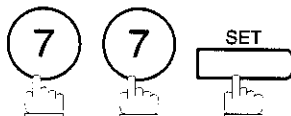

```
77 LOGO/DEPT. CODE
1:INVALID
```

4



```
77 LOGO/DEPT. CODE
2:MULTI-LOGO
```

5

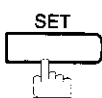

```
MULTI-LOGO (01-24)
ENTER NO. OR v ^
```

6

Enter LOGO number.

Ex: ① ② (01 to 24)

```
LOGO/DEPT. NAME
12 ■
```

7

Enter your LOGO (max. 25 characters and digits) by using character keys. (See page 12)

Ex: P A N A S O N I C SPACE
S A L E S (See Note 1)

```
LOGO/DEPT. NAME
12 PANASONIC SALES■
```

8

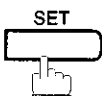

To record another LOGO, repeat step 6 to 8. To return to standby, press **STOP**.

```
LOGO/DEPT. NAME
13 ■
```

! Note:

1. Use **COPY** to copy the default LOGO which is set in the User Parameters. You can add the department name following the default LOGO.

Multiple LOGO ◀

Changing or Erasing the Multiple LOGO

If you have to change or erase any of the Multiple LOGOs, follow the steps below.

1

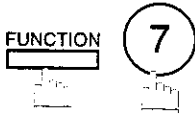

```
SET MODE (1-6)
ENTER NO. OR v ^
```

2

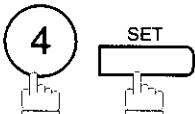

```
FAX PARAMETER (01-99)
NO. =■
```

3

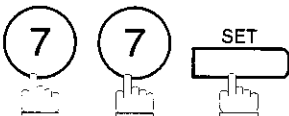

```
77 LOGO/DEPT. CODE
2: MULTI-LOGO
```

4

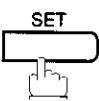

```
MULTI-LOGO (01-24)
ENTER NO. OR v ^
```

5

Enter the LOGO number you wish to change or erase.

Ex: ① ② (01 to 24)

```
LOGO/DEPT. NAME
12 PANASONIC SALES
```

6



then enter a new LOGO (See Note 1 and 2).

Ex: P A N A F A X SPACE

S A L E S

or just go to step 7 to erase the LOGO.

```
LOGO/DEPT. NAME
12
```

7



To return to standby, press **STOP**.

```
LOGO/DEPT. NAME
13 ■
```

5

! Note:

1. If you make a mistake, use ◀▶ to move the cursor beyond the incorrect character, press **CLEAR** then re-enter the correct LOGO.
2. Use **COPY** to copy the default LOGO which is set in the User Parameters. You can add the department name following the default LOGO.

Multiple LOGO

Sending Document with Multiple LOGO

1



Set document(s) face down.

ENTER STATION(S)
THEN PRESS START 00%

2

Dial by any combination of the following methods:

- One-Touch Dialling
- Abbreviated Dialling
- Manual Number Dialling, press after each station is entered
(UF-895: Up to 70 stations, UF-885: Up to 32 stations)
- Directory Search Dialling, press after each station is entered
(For details, see page 46 to 49.)

Ex:

<01>(Station name)
5551234

3

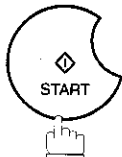

SELECT LOGO (00-24)
ENTER NO. OR v ^

4

Enter the LOGO No. or use or to select the LOGO that you want to use. (See Note 2)

12 PANASONIC SALES

Ex: ① ②

5

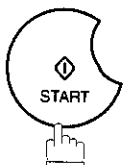

The document is sent with the header of the selected LOGO. The selected LOGO is printed on the COMM. Journal, Individual Transmission Journal and Cover Sheet.

! Note:

1. The Multiple LOGO function cannot be used in the Voice Dialling Mode.
2. If you skip selecting the LOGO in the step 4, the unit selects the default LOGO (00) which is set in the User Parameters.

Multiple LOGO ◀

Printing a Multiple Logo List

The Multiple Logo List can be printed out following the Fax Parameter List.

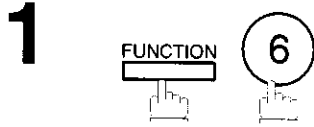

```
PRINT OUT      (1-7)
ENTER NO. OR v ^
```

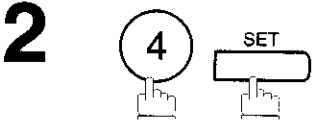

```
* PRINTING *
FAX PARAMETER LIST
```

5

Sample Multiple LOGO List (Prints following the Fax Parameter List)

```
***** -FAX PARAMETER LIST- ***** DATE 12-JAN-1999 ***** TIME 15:00 *** P.02

MULTI-LOGO LIST

(1)      (2)
NUMBER   LOGO

01      Panafax Sales
02      Panafax Service
03      Panafax Accounting

}
}

24      Panafax Engineering

***** -PANASONIC . -
***** -HEAD OFFICE - ***** - 201 555 1212 - *****
```

Explanation of contents

- (1) LOGO Number : 01-24
- (2) Multiple LOGO : Up to 25 characters



© 2012 by the Board of Regents of the University of Wisconsin System

This page is intentionally left blank.



Selective Reception ◀

Your machine has a special feature, Selective Reception, which can prevent the receiving of unnecessary documents (i.e. junk fax, direct mail, etc.).

Before receiving the document, the last 4 digits of the ID Number received from the sending machine will be compared with the last 4 digits of the telephone number programmed in each One-Touch or Abbreviated station. When a match is found, your machine will start receiving the document. If a match is not found, your machine will cancel the reception and an Information Code 406 will be recorded on the Journal.

Setting the Selective Reception

1

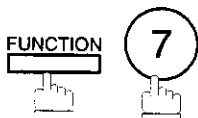

SET MODE (1-6)
ENTER NO. OR ∨ ^

6



2

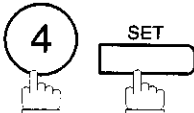

FAX PARAMETER (01-99)
NO. = ■

3

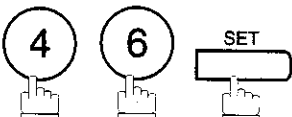

46 SELECT RCV
1: INVALID

4



46 SELECT RCV
2: VALID

5

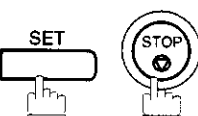

! **Note:**

1. When the Selective Reception is set, your machine can receive only from those stations which are programmed in the built-in auto-dialer.
2. If your ID number has not been set, your machine might not be able to receive from some models.
To set your ID number, see page 27.

▶ Password Communications

General Description

Password Communications, including Password Transmission and Password Reception will prevent your machine from sending a fax to a wrong station or receiving a fax from an unauthorized stations. You can set Password Transmission and Password Reception independently, or both together.

To use Password Transmission, you must set a 4-digit transmission password in advance. The password must be shared with other compatible Panafax machine(s). If the transmission password in your machine does not match the transmission password in the other compatible Panafax machine(s), the transmission will fail. You can select password transmission by setting Function 8-4 (PASSWORD-XMT) to "ON" when you send a document.

To use Password Reception, you must set a 4-digit receiving password in advance. The password must be shared with the other compatible Panafax machine(s). If the password in your machine does not match the receiving password in the other compatible Panafax machine(s), the reception will fail. Once you set password reception and set the parameter to "ON", it stays until you change the setting to "OFF".

Compatibility with Other Machines

You can only use password transmission and reception with another Panafax compatible machine(s) listed below.

Model	Special Settings
DF-1100	
UF-160	
UF-160M	
UF-170	
UF-260	
UF-270	
UF-270M	
UF-280M	
UF-300	
UF-312	
UF-322	
UF-550	
UF-560	
UF-650	Required.
UF-733	Please refer to the individual User's Guide of each model.
UF-744	
UF-745	
UF-750	
UF-750D	
UF-755	
UF-755e	
UF-766	
UF-770	
UF-788	
UF-880	
UF-885	
UF-895	
UF-M500	

Password Communications

Setting Password Transmission

To set transmission password and parameter,

1  



2  





3   

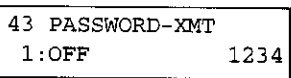

4 Enter a 4-digit Transmission Password.
Ex: ① ② ③ ④ and press 



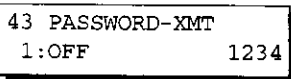

5  for "OFF" (password is not checked)
or
 for "ON" (password is checked)



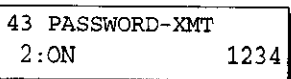

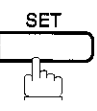
or



6  

6

-  **Note:**
1. You can change the setting temporarily by using FUNCTION 8-4 (PASSWORD-XMT) for each transmission. See page 115 for details.
 2. To change the password, press  in step 4. Then re-enter a new one.

▶ Password Communications

Setting Password Reception

To set receiving password and parameter,

1

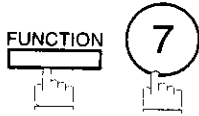

SET MODE (1-6)
ENTER NO. OR v ^

2

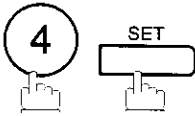

FAX PARAMETER(01-99)
NO. =■

3

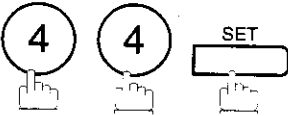

44 PASSWORD-RCV
■■■■

4

Enter a 4-digit Receiving Password.

Ex: ① ② ③ ④ and press SET

44 PASSWORD-RCV
1:OFF 1234

5



for "OFF" (password is not checked)

or



for "ON" (password is checked)

44 PASSWORD-RCV
1:OFF 1234

or

44 PASSWORD-RCV
2:ON 1234

6

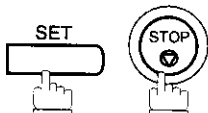

! Note:

- Once you set the parameter, you cannot select the parameter, "OFF" or "ON", for each reception. It is always "OFF" or "ON" until you change the setting.
- To change the password, press CLEAR in step 4. Then re-enter a new one.

Password Communications

Using Password Transmission

To use Password Transmission, you can select PASSWORD-XMT "OFF" or "ON" for each Transmission by following the procedure below.

1



Set document(s) face down.

ENTER STATION(S)
THEN PRESS START 00%

2

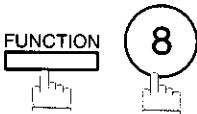

SELECT MODE (1-5)
ENTER NO. OR V ^

3

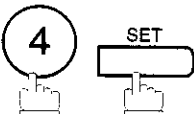

PASSWD-XMT=OFF
1:OFF 2:ON

4

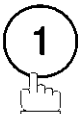

for "OFF" (password is not checked)

or



for "ON" (password is checked)

PASSWD-XMT=OFF
1:OFF 2:ON

or

PASSWD-XMT=ON
1:OFF 2:ON

5



ENTER STATION(S)
THEN PRESS START

6

Dial by any combination of the following methods:

- One-Touch Dialling
- Abbreviated Dialling
- Manual Number Dialling, press **SET** after each station is entered
(UF-895: Up to 70 stations, UF-885: Up to 32 stations)
- Directory Search Dialling, press **SET** after each station is entered
(For details, see page 46 to 49.)

Ex:

<01>(Station name)
5551234

Continued on the next page.

6

▶ Password Communications

7

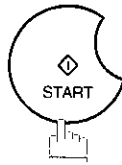

If your machine's Transmission Password coincides with the other station's Transmission Password, your machine starts sending the document.

When transmission is completed, PASSWORD-XMT returns to standard setting ("OFF" or "ON").

Using Password Reception

There is no additional operation required once you set the parameter by following the procedure on page 114. The parameter, "OFF" or "ON", cannot be selected for each reception. It is always "OFF" or "ON" until you change the setting.

Confidential Mailbox and Confidential Network Communications

Your machine is equipped with two Confidential Communication features which ensure that the Confidential information you send is received only by the person with the correct confidential code.

Confidential Mailbox

The confidential mailbox feature can be used as a mailbox to communicate with other compatible models using a 4-digit confidential code. The Confidential Mailbox feature receives document(s) with a confidential code into memory. These documents can only be printed by the person who has the correct confidential code.

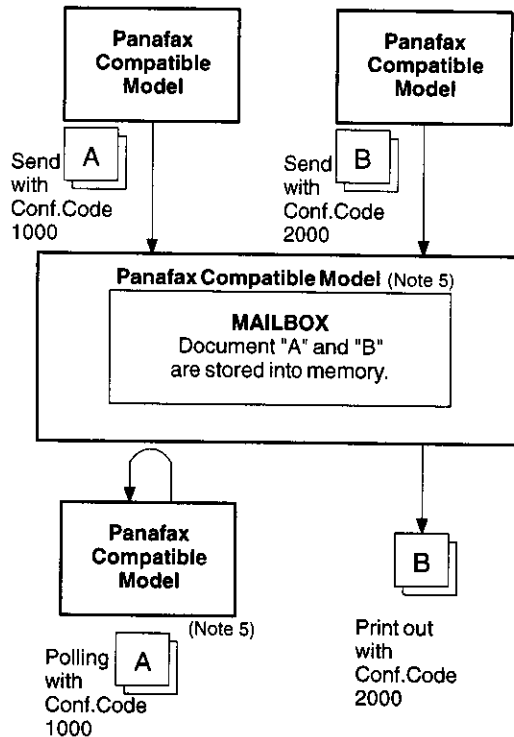

Figure 1 : Confidential Mailbox

Compatibility with Other Machines

Table 1 shows a list of compatible Panafax models which have the Confidential Mailbox feature. It also shows whether or not special settings are required.

Table 1 : Confidential Mailbox Requirement

Compatible Model						Special Settings
DF-1100	UF-280M	UF-312	UF-322	UF-332	UF-342	Not Required.
UF-344	UF-550	UF-560	UF-733	UF-744	UF-745	
UF-755	UF-755e	UF-766	UF-770	UF-788	UF-880	
UF-885	UF-895					

! Note:

1. If your machine receives two confidential faxes with same confidential code, both documents are stored together in the same confidential mailbox.
2. Up to 20* Mailbox files can be stored in memory. So, you can receive the confidential fax using 20* different confidential codes. (*UF-885 : Up to 10 Mailbox files)
3. If the memory overflows, the machine will stop receiving and release the line.
4. We recommend that optional flash memory card be installed when this function is used. See page 168 on Image Memory Capacity.
5. If confidential faxes were received in the mailbox of UF-733, you cannot poll those documents. The UF-733 is designed to print out the received confidential document locally only.

6

Confidential Mailbox and Confidential Network Communications

Sending a Confidential Document to a Remote Station's Mailbox

1



Set document(s) face down.

ENTER STATION(S)
THEN PRESS START 00%

2

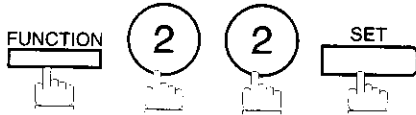

CONF. COMM. (1-5)
ENTER NO. OR v ^

3

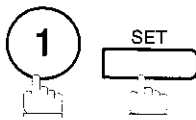

CONFIDENTIAL XMT
CONF. CODE=■■■■

4

Enter a 4-digit Confidential Code.

Ex: (2)(2)(3)(3)

CONFIDENTIAL XMT
CONF. CODE=2233

5

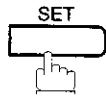

ENTER STATION
THEN PRESS START

6

Dial by any one of the following methods:

- One-Touch Dialling
- Abbreviated Dialling
- Manual Number Dialling
- Directory Search Dialling

Ex: 01

<01>(Station name)
5551234

7

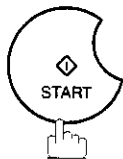

If necessary, inform the receiving person and tell them the Confidential Code.

- !** **Note:**
1. If the receiving station has a Network Password, you must set the same password, shared by the receiving station, to send confidential fax. (See pages 126 and 127)

Confidential Mailbox and Confidential Network Communications

Polling a Confidential Document from a Remote Station's Mailbox

After you have been informed that someone has transmitted a confidential document to a remote station's mailbox, you can poll the confidential document from the remote station by following the procedure below.

1

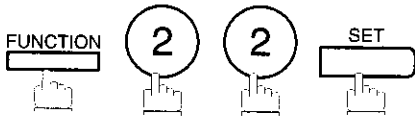

```
CONF. COMM. (1-5)
ENTER NO. OR v ^
```

2

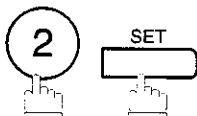

```
CONFIDENTIAL POLL
CONF.CODE=■■■■
```

3

Enter a 4-digit Confidential Code.

Ex: (2)(2)(3)(3)

```
CONFIDENTIAL POLL
CONF.CODE=2233
```

4

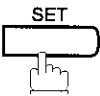

```
ENTER STATION
THEN PRESS START
```

5

Dial by any one of the following methods:

- One-Touch Dialling
- Abbreviated Dialling
- Manual Number Dialling
- Directory Search Dialling

Ex: 01

```
<01>(Station name)
5551234
```

6

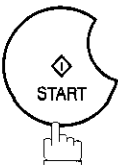

6

! **Note:** 1. The confidential file will be erased automatically at the center station after being polled.

Confidential Mailbox and Confidential Network Communications

Receiving a Confidential Document to Your Machine's Mailbox

No special setting is required, your machine comes with this feature ready to use. Your machine receives a confidential fax the same way it receives a normal fax message. When receiving the confidential fax, the display shows the following message (CONF. RCV REPORT) and prints out the Confidential Receive Report.

MESSAGE IN MAIL BOX

Sample CONF. RCV Report

```
*****-CONF. RCV REPORT- *****DATE 12-JAN-1999 *****TIME 15:00 *****
      ** NOTICE OF CONFIDENTIAL DOCUMENT HELD **
(1)      (2)      (3)      (4)
FILE NO. RECEIVED FROM      PAGES      TIME RECEIVED
      040      PANAFAX      001      12-JAN 15:00
                                      -PANASONIC -
*****-HEAD OFFICE      -**** -      201 555 1212- *****
```

Explanation of contents

- (1) File number : 001 to 999
- (2) Received remote station's ID : Character ID or Numeric ID
- (3) Number of pages received
- (4) Received date and time



Note:

1. If your machine receives two confidential faxes with same confidential code, both documents are stored together in the same confidential mailbox.
2. Up to 20* Mailbox files can be stored in memory. So, you can receive the confidential fax using 20* different confidential codes. (*UF-885 : Up to 10 Mailbox files)
3. If the memory overflows, the machine will stop receiving and release the line.
4. You can verify whether the unit has received a confidential fax by printing out the File List. (See page 77)

Confidential Mailbox and Confidential Network Communications

Storing a Confidential Document in Your Machine's Mailbox

Use the following procedure to store a document in a confidential mailbox in your machine. Once the confidential document is stored in your machine, it can be polled by another machine.

1



Set document(s) face down.

ENTER STATION(S)
THEN PRESS START 00%

2

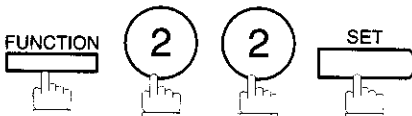

CONF. COMM. (1-5)
ENTER NO. OR V ^

6
||

3

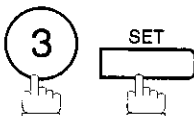

CONFIDENTIAL POLLED
CONF. CODE=■■■■

4

Enter a 4-digit Confidential Code.

Ex: (2)(2)(3)(3)

CONFIDENTIAL POLLED
CONF. CODE=2233

5

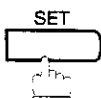

The document(s) will be stored into memory.
If necessary, inform the receiving party of the confidential document and tell them the confidential code needed to poll the document.

* STORE * NO.002
PAGES=001 01%



Note:

- The confidential file will be erased automatically after being polled.
If you wish to retain the confidential file even after being polled, change the setting of Fax Parameter No. 42 (CONF. POLLED FILE SAVE) to "Valid".

▶ Confidential Mailbox and Confidential Network Communications

Printing Out a Confidential Document from Your Machine's Mailbox

After you have been notified that someone has transmitted a confidential document to your machine's mailbox, use the following procedure to print out the confidential document.

1



FUNCTION 2 2 SET



CONF. COMM. (1-5)
ENTER NO. OR v ^

2



4 SET



PRINT CONF. FILE
CONF. CODE=■■■■

3 Enter the Confidential Code of the document you want to print out.

Ex: ②②③③

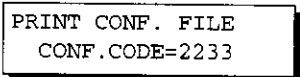

PRINT CONF. FILE
CONF. CODE=2233

4



SET

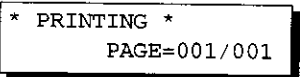

* PRINTING *
PAGE=001/001

The machine will print out the confidential documents.

- !** **Note:**
1. The confidential file will be erased automatically after being printed out even if the setting of Fax Parameter No. 42 (CONF. POLLED FILE SAVE) is changed to "Valid".

Confidential Mailbox and Confidential Network Communications

Deleting a Confidential Document Stored in Your Machine's Mailbox

If your memory becomes full, or you just want to clean out your confidential documents, you may delete one or more confidential faxes stored in your machine by using the following procedure.

There are two types of confidential file deletions, one is to delete the file individually by its Confidential Code, and the other is to delete all confidential files in memory.

To delete a file using Confidential Code

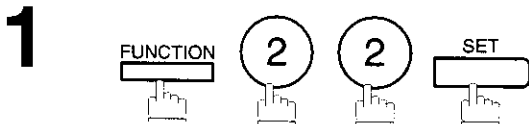

CONF. COMM. (1-5)
ENTER NO. OR ∨ ^

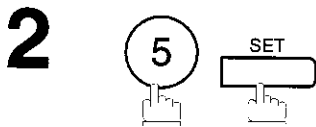

DELETE CONF. FILE
CONF.CODE=■■■■

3 Enter a 4-digit Confidential Code.

Ex: ② ② ③ ③

DELETE CONF. FILE
CONF.CODE=2233

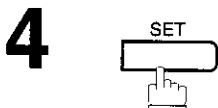

* DELETING *
CONF.CODE=2233

To delete all confidential files in memory

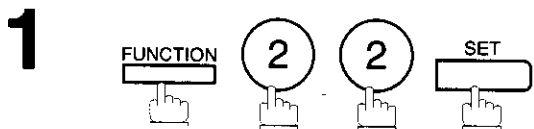

CONF. COMM. (1-5)
ENTER NO. OR ∨ ^

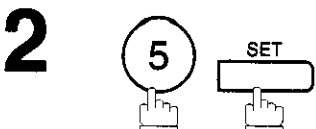

DELETE CONF. FILE
CONF.CODE=■■■■

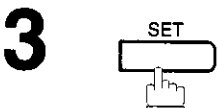

DELETE ALL CONF.
FILES? 1:YES 2:NO

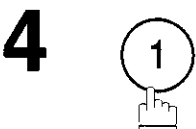

* DELETING *
ALL CONF. FILES

6

Confidential Mailbox and Confidential Network Communications

Confidential Network Communications (Via a Center Station)

The Confidential Network Communication requires a Center Station such as a UF-650 to communicate with other Panafax models which have confidential communication features. First the Initial Sending Station sends a confidential document to the Center Station together with a Confidential Code. The document will remain in the center station's memory until polled by the End Receiving Station. In the example given in figure 2, the End Receiving Station must know the Confidential code attached to the document.

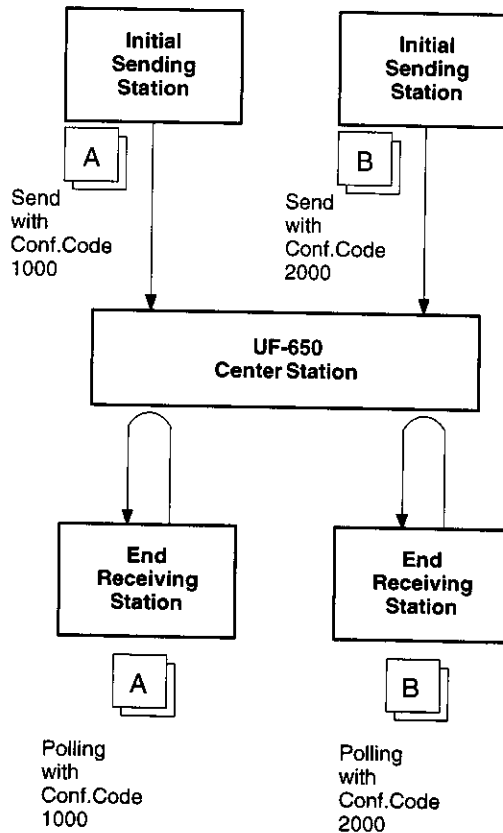

Figure 2 : Sending Confidential Faxes via a Center Station

If a UF-650 or UF-620 is the Center Station, more than one document can be stored in the same memory file using the same Confidential Code. That is, you can keep adding faxes to the file, just like putting mail in a mailbox, until the memory is full. If a UF-640 is the Center Station, you cannot add a fax to the file which has the same Confidential Code attached with a file already stored in the memory. Whichever station you use, you can create more than one file, each with a different Confidential Code.

The stored confidential document will be available to be polled by the end receiving station.

Once you have polled or printed the confidential document from the Center Station, the document is automatically erased from the Center Station's memory.

Confidential Mailbox and Confidential Network Communications

Compatibility with Other Machines

Table 1 shows how your machine fits in with the compatibility requirements of the different kinds of facsimile stations which make up a Network for Confidential Communications. It also shows whether or not special settings are required.

Table 1: Confidential Communication Requirement

Station	Compatible Model	Special Settings
Initial Sending Station	DF-1100, Panafax 145, Panafax 155, UF-140, UF-150, UF-160, UF-160M, UF-170, PD-170E, UF-250, UF-260, UF-270, UF-270M, UF-280M, UF-300, UF-312, UF-322, UF-342, UF-344, UF-550, UF-560, UF-620, UF-640, UF-650, UF-733, UF-744, UF-745, UF-750, UF-750D, UF-755, UF-755e, UF-766, UF-770, UF-788, UF-880, UF-885, UF-895	Required. Please refer to the individual User's Guides of each machine.
Confidential Center Station	UF-620, UF-640, UF-650	
End Receiving Station	DF-1100, Panafax 145, Panafax 155, UF-140, UF-150, UF-160, UF-160M, UF-170, PD-170E, UF-250, UF-260, UF-270, UF-270M, UF-280M, UF-300, UF-312, UF-322, UF-332, UF-342, UF-344, UF-550, UF-560, UF-620, UF-640, UF-650, UF-733, UF-744, UF-745, UF-750, UF-750D, UF-755, UF-755e, UF-766, UF-770, UF-788, UF-880, UF-885, UF-895	

6
=

Setting Up Your Machine for Confidential Network Communications

To use Confidential Communications, you must first preset the Confidential Communication Fax Parameter described below. Then, every time you actually send a Confidential Fax you must set a Confidential Code.

1. Confidential Communication Fax Parameter

This switches the Confidential Communications function to "Valid" or "Invalid".

2. Own Telephone Number

The full telephone number should be entered.

3. Network Password and Polling Password

You may use Network Password and Polling Password to prevent outside facsimile(s) from using the Confidential Communication network. The same password must be provided to all the machines inside the network.

4. Confidential Code

A 4-digit code must be assigned to each Confidential Fax you send. It identifies the fax when it is stored in the Relay Station. The receiving person must know the code in order to poll the fax from the Relay Station.

Confidential Mailbox and Confidential Network Communications

To set the Fax Parameter for Confidential Network Communication

1

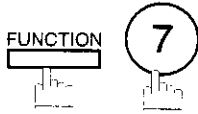

SET MODE (1-6)
ENTER NO. OR ∨ ^

2

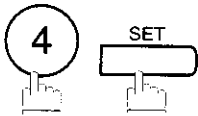

FAX PARAMETER (01-99)
NO. =■

3

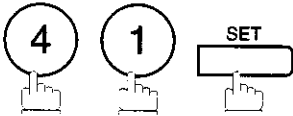

41 CONF. FAX PARA.
1: INVALID

4



41 CONF. FAX PARA.
2: VALID

5

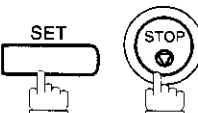

Confidential Mailbox and Confidential Network Communications

To set your own Telephone Number and Network Password

1

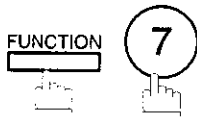

SET MODE (1-6)
ENTER NO. OR v ^

2

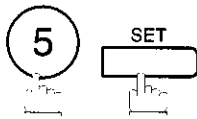

OWN TELEPHONE NO.
█

3

Enter your telephone number (max. 36 digits).

Ex: ① SPACE ② ① ② SPACE
① ① ① SPACE ① ② ③ ④

OWN TELEPHONE NO.
1 212 111 1234█

4



NETWORK PASSWORD
████

5

Enter a 4-digit Network Password.

Ex: ⑨ ⑨ ⑨ ⑨

NETWORK PASSWORD
9999

6



OWN NETWORK ADDRESS
████

7



6

▶ Relayed Transmission

General Description

The Relayed Transmission feature can save you time and transmission costs if you need to send the same documents to multiple G3 fax machines. This is especially true if the transmissions are long distance.

To use Relayed Transmission, you must be part of a "Relay Network" built around a "Relay Station". That is, when you send a document by Relayed Transmission, you actually send it to a Relay Station together with instructions to relay it to one or multiple end receiving station(s).

The Relay Station first receives the document in its memory and then relays it to the end receiving station(s).

Example:

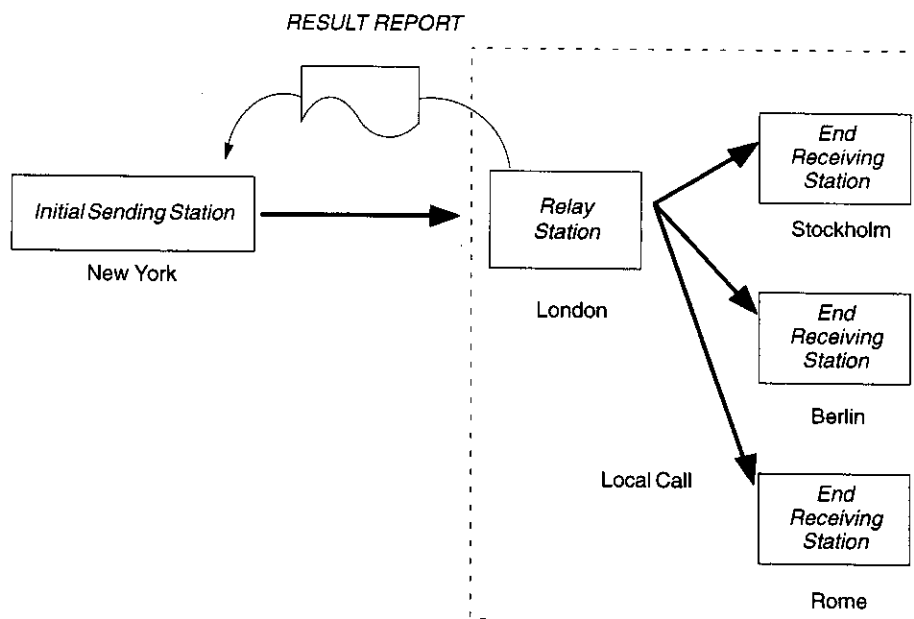

Compatibility with Other Machines

Table 1 shows the kind of facsimile machines which can make up a Relay Network used for Relayed Transmission. Note that your machine can serve as an Initial Sending Station or End Receiving Station.

Table 1 : Relay Network Compatibility Requirements

Station	Compatible Model				Special Settings
Initial Sending Station	DF-1100	UF-312	UF-745		Required. Please refer to the individual User's Guides of each machine.
	UF-150	UF-322	UF-750		
	UF-160	UF-342	UF-750D		
	UF-160M	UF-344	UF-755		
	UF-170	UF-550	UF-755e		
	UF-250	UF-560	UF-766		
	UF-260	UF-620	UF-770		
	UF-270	UF-640	UF-788		
	UF-270M	UF-650	UF-880		
	UF-280M	UF-733	UF-885		
	UF-300	UF-744	UF-895		
Relay Station	UF-620	UF-650	UF-640	UF-M500	
End Receiving Station	ITU-T/CCITT G3 Compatible machines				Not required.

Relayed Transmission ◀

Relay Network

A Relay Network is basically a group of facsimiles programmed to communicate with each other via a Relay Station. In this case, the word programmed means that certain numbers have been stored in the memory of each machine. These numbers, also called parameters, are needed to identify the machines in the network.

Since your machine can only serve as an Initial Sending Station or End Receiving Station in a Relay Network, it is assumed that you will not have to establish the network yourself. All you have to do is follow the set up procedure described here, and certain instructions provided by the network organizer (usually the person controlling the Relay Station). You should know, however, what kind of network you are going to connect to, and how it works. A sample network is shown in figure 1.

Figure 1 shows a sample network as seen from New York. London and Singapore are Relay Stations connected to New York. Viewed from New York, Stockholm, Berlin, Rome, Tokyo, Hong Kong, Wellington and Sydney are End Receiving Stations.

With this simple network using two Relay Stations, you can send a document with one operation to any combination of stations in the network via the London Relay Station and/or Singapore Relay Station. If New York only transmits to one station, for example, then the document will go directly to the station or indirectly via the Relay Station depending on the One Station XMT Parameter you preset.

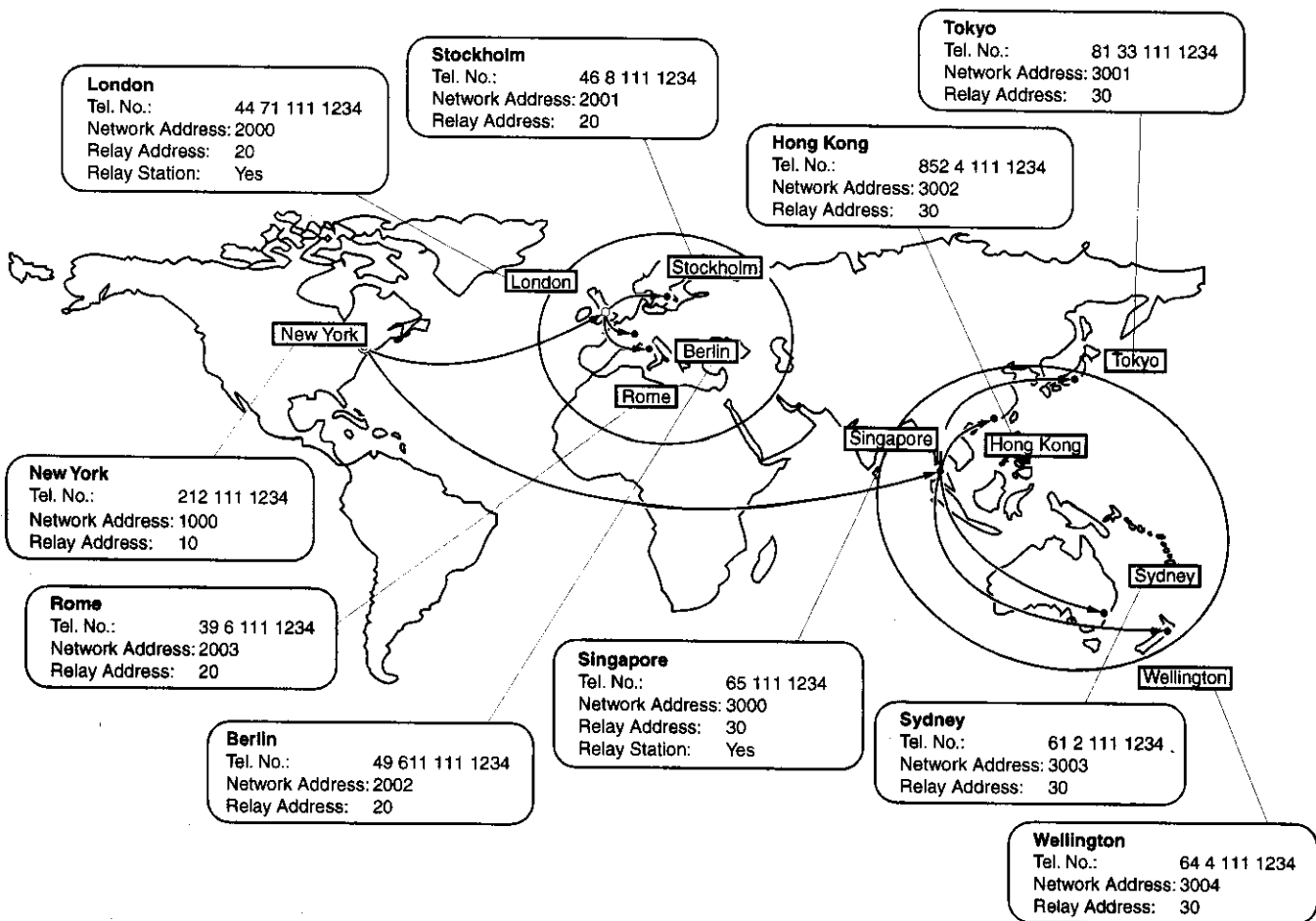

Figure 1 : Sample Network

6
||

▶ Relayed Transmission

Table 2, 3 and 4 are sample settings for a Sample Network.

Table 2 : Sample Parameter and Abbreviated Dialling Number Table for New York

Telephone Number : 212 111 1234
 Network Address : 1000
 Relay Address : 10

One-Touch/ ABBR No.	Station Name	Telephone Number	Relay Address	Relay Station Yes/No	Network Address	One Station XMT
01	London	44 71 111 1234	20	Yes	2000	Direct
02	Stockholm	46 8 111 1234	20	No	2001	Direct
03	Berlin	49 611 111 1234	20	No	2002	Direct
04	Rome	39 6 111 1234	20	No	2003	Direct
05	Singapore	65 111 1234	30	Yes	3000	Direct
06	Tokyo	81 33 111 1234	30	No	3001	Direct
07	Hong Kong	852 4 111 1234	30	No	3002	Direct
08	Sydney	61 2 111 1234	30	No	3003	Direct
09	Wellington	64 4 111 1234	30	No	3004	Direct

Table 3 : Sample Parameter and Abbreviated Dialling Number Table for London

Telephone Number : 71 111 1234
 Network Address : 2000
 Relay Address : 20

One-Touch/ ABBR No.	Station Name	Telephone Number	Relay Address	Relay Station Yes/No	Network Address	One Station XMT
01	Stockholm	46 8 111 1234	20	No	2001	Direct
02	Berlin	49 611 111 1234	20	No	2002	Direct
03	Rome	39 6 111 1234	20	No	2003	Direct
04	New York	1 212 111 1234	10	No	1000	Direct
05	Singapore	65 111 1234	30	Yes	3000	Direct
06	Tokyo	81 33 111 1234	30	No	3001	Direct
07	Hong Kong	852 4 111 1234	30	No	3002	Direct
08	Sydney	61 2 111 1234	30	No	3003	Direct
09	Wellington	64 4 111 1234	30	No	3004	Direct

Table 4 : Sample Parameter and Abbreviated Dialling Number Table for Singapore

Telephone Number : 65 111 1234
 Network Address : 3000
 Relay Address : 30

One-Touch/ ABBR No.	Station Name	Telephone Number	Relay Address	Relay Station Yes/No	Network Address	One Station XMT
01	New York	1 212 111 1234	10	No	1000	Direct
02	London	44 71 111 1234	20	Yes	2000	Direct
03	Stockholm	46 8 111 1234	20	No	2001	Direct
04	Berlin	49 611 111 1234	20	No	2002	Direct
05	Rome	39 6 111 1234	20	No	2003	Direct
06	Tokyo	81 33 111 1234	30	No	3001	Direct
07	Hong Kong	852 4 111 1234	30	No	3002	Direct
08	Sydney	61 2 111 1234	30	No	3003	Direct
09	Wellington	64 4 111 1234	30	No	3004	Direct

Setting Up Your Machine for Relayed Transmission

To set up your machine for Relayed Transmission, use the procedures on the following pages to set the parameters listed below. Some parameters (e.g., Fax Parameter No. 40 (RELAY XMT REQUEST)) are only set once, but others must be set separately for each station in the Relay Network.

1. Relay XMT Request (Fax Parameter No. 40)

Selecting whether the machine will accept and perform G3 relayed transmission. (See page 37)

2. Own Telephone Number (FUNCTION 7 5 SET)

Enter the full telephone number of your machine in order for the Relay Station to send you a Result Report.

3. Network Password (FUNCTION 7 5 SET)

Enter a 4-digit Network Password to be used for protection against unauthorized (outside) stations from accessing your machine to relay messages to G3 fax machines via PSTN. This password should be given out to authorized people only. Every Relay requesting stations and Relay stations in the network should have the same Network Password.

4. Own Network Address (FUNCTION 7 5 SET)

Enter a 4-digit Own Network Address in order for the Relay Station to send you a Result Report.

5. One-Touch/ABBR Numbers (Auto Dialer)

Enter the One-Touch or ABBR Number that represents the end receiving station's fax telephone number in the network as seen from your station.

1) Relay Station (Yes/No) Parameter (Auto Dialer)

Set this parameter to "Yes" if the particular station you are recording is a Relay Station. If you are connected to more than one Relay Stations in series, set "Yes" only for the first Relay Station.

2) Relay Address (Auto Dialer)

Enter a 2-digit number which identifies the Relay Station your machine will use. Your machine may be connected to more than one Relay Station in parallel, but when you use Relay XMT Request your machine will only send documents to the Relay Station identified by the Relay Address.

3) Network Address (Auto Dialer)

End Receiving Station telephone numbers set in the Initial Sending Station may be different from the numbers set in a Relay Station. To send a fax to an End Receiving Station via a Relay Station each station in the network must be identified with a certain code which does not vary depending on where you call from. The code is the Network Address, which consists of a 4-digit number and is assigned to a One-Touch/ABBR number.

4) One Station XMT (Relay/Direct) Parameter (Auto Dialer)

If you send a document(s) to only one End Receiving Station, you can set your machine to transmit directly to that station, without going through the Relay Station, by selecting "No". Set it to "Yes" if you always want to use the Relay Station.

▶ Relayed Transmission

To set the Relayed XMT FAX Parameters;

1

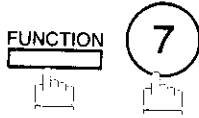

SET MODE (1-6)
ENTER NO. OR v ^

2

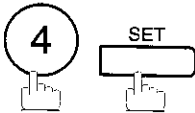

FAX PARAMETER(01-99)
NO.=■

3

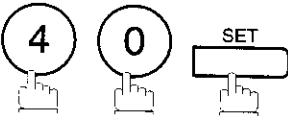

40 RELAY XMT REQUEST
1:INVALID

4



40 RELAY XMT REQUEST
2:VALID

5

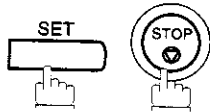

To set your Own Telephone Number, Network Password and Own Network Address;

1

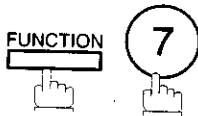

SET MODE (1-6)
ENTER NO. OR v ^

2

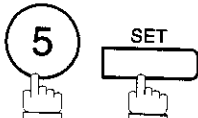

OWN TELEPHONE NO.
■

3

Enter your machine's full telephone number (max. 36 digits).

Ex: ① SPACE ② ① ② SPACE
① ① ① SPACE ① ② ③ ④

OWN TELEPHONE NO.
1 212 111 1234■

4

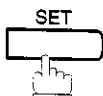

NETWORK PASSWORD
■■■■

Continued on the next page.

Relayed Transmission ◀

5 Enter a 4-digit Network Password.

Ex: (9)(9)(9)(9)

NETWORK PASSWORD
9999



6 

OWN NETWORK ADDRESS
■■■■

7 Enter your own 4-digit Network Address.

Ex: (1)(0)(0)(0)

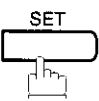
OWN NETWORK ADDRESS
1000



8  

6

To set a One-Touch/ABBR. Dialling Number, Relay Station (Yes/No) Parameter, Relay Address, Network Address and One Station XMT (Relay/Direct Parameter);

1  

SET MODE (1-6)
ENTER NO. OR ∨ ^

2  

1: ONE-TOUCH
2: ABBR NO.

3 

ONE-TOUCH< >
PRESS ONE-TCH OR ∨ ^

4 Ex:

<01>
ENTER TEL. NO.

5 Enter the fax telephone number of the end receiving station (up to 36 digits including pauses and spaces).

Ex: (4)(6) SPACE (8) SPACE (1)(1)(1) SPACE
 (1)(2)(3)(4)

<01>
46 8 111 1234■

6 

<01> ENTER NAME
46 8 111 1234

Continued on the next page.

▶ Relayed Transmission

7 Enter the station name.

Ex:
and press

```
<01> Stockholm
46 8 111 1234
```

8

```
<01> RELAY STN? 2
1:YES 2:NO
```

9 If the recorded station is a Relay Station, press **1**.
If not, press **2**.

Ex: **2**

```
<01> RELAY ADDRESS
```

10 Enter a 2-digit Relay Address which identifies the Relay Station your machine will use.

Ex: **2** **0**

```
<01> RELAY ADDRESS
20
```

11

```
<01> NETWORK ADDRESS
```

12 Enter a 4-digit Network Address

Ex: **2** **0** **0** **1**

```
<01> NETWORK ADDRESS
2001
```

13

```
<01> 1-STN RELAY? 2
1:RELAY 2:DIRECT
```

14 If the station you have just recorded will be used for one-station transmission, you can preset the transmission route.

1: To transmit via a Relay Station

2: To transmit directly.

Ex: **2**

```
ONE-TOUCH< >
PRESS ONE-TCH OR v ^
```

Repeat step 4 through 14 to enter the numbers for other stations, or return to standby by pressing .

Print out a list of One-Touch/ABBR numbers or Directory Search List to confirm that you have recorded everything correctly. For the printout operation, refer to page 147.

Relayed Transmission ◀

Sending a Document by Relayed Transmission

Once you have recorded all the necessary parameters in your machine in accordance to the Relay Network that you belong to, you can send a document to one or multiple G3 fax machines automatically through the Relay Station by using the procedure described below. The Relay Network must have all the necessary parameters setup.

1



Set document(s) face down.

ENTER STATION(S)
THEN PRESS START 00%

2

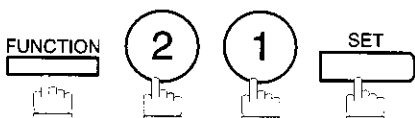

ENTER STATION(S)
THEN PRESS START 00%

3

Enter only the telephone number(s) of the End Receiving Station(s) using any combination of the following methods:

- One-Touch Dialling
- Abbreviated Dialling
- Directory Search Dialling, press after each station is entered
(For details, see page 47 to 49)

Ex:

<01> (Station name)
5551234

4

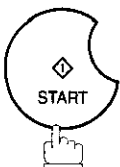

The document is stored into memory and your machine starts dialling the number of the Relay Station and sends the document.

* STORE * NO. 001
PAGES=001 01%

After the Relay Station completes its transmission to the End Receiving Station(s), your machine receives a COMM. Journal from the Relay Station. This Journal confirms whether the Relayed Transmission(s) was successful.



Note:

1. You cannot use manual number dialling in step 3.

6

▶ Relayed Transmission

Printouts and Reports

When you use Relayed Transmission, your machine will print the following two reports to help you check and keep track of your faxes.

1. Relay XMT Report (COMM. JOURNAL)

When your machine finishes transmitting to the Relay Station, it will print a COMM. Journal when the Fax Parameter No. 12 (COMM. JOURNAL) is set to "2:Always", this tells you whether the transmission was successful or not.

2. Result Report

After the Relay Station completes its transmission to the End Receiving Station(s), your machine receives and prints the Relay XMT Result Report. This report confirms whether the Relayed Transmission was successful.

Sample Relay XMT Report (COMM. JOURNAL)

```

***** -COMM. JOURNAL - ***** DATE 12-JAN-1999 **** TIME 15:00 *****

(1)
MODE = MEMORY RELAYED TRANSMISSION
FILE NO.= 050 (4)

(2)
START= 12-JAN 14:50

(3)
END= 12-JAN 15:00

(5)  (6)  (7)  (8)  (9)  (10)  (11)
STN NO. COMM. ABBR NO. STATION NAME/TEL NO. PAGES DURATION RLY STN
001    R-OK <01>/2000  LONDON           001/001          00:01:30        <01>/2000
002    R-OK <02>/2001  STOCKHOLM        001/001          RELAY            <01>/2000
003    R-OK <03>/2002  BERLIN           001/001          RELAY            <01>/2000
004    R-OK <04>/2003  ROME             001/001          RELAY            <01>/2000

- PANASONIC -

***** - HEAD OFFICE - ***** - 201 555 1212 - *****
    
```

- (1) Indication of communication mode
- (2) Start time of communication
- (3) End time of communication
- (4) File number : 001 to 999
- (5) Sequential number of the stations
- (6) Communication result : "R-OK" indicates that the Relayed XMT Request was successful. 3-digit Info Code (See page 155) indicates that the communication has failed.
- (7) Abbreviated number and Network Address
- (8) Recorded name in One-Touch or ABBR Number dialling
- (9) Number of pages transmitted : 3-digit number is the number of pages successfully transmitted.
- (10) Duration of communication : The communication that was requested to be transferred via the relay station is shown as "RELAY".
- (11) Relay station's ABBR. NO. / Network Address



Note: 1. If you transmit through more than one Relay Station, you will receive a separate Result Report.

Relayed Transmission ◀

Sample Result Report (Relay XMT Result)

```

(1)
12-JAN-1999 12:10 FROM LONDON TO NEW YORK P.001/001

*****-RESULT REPORT- ***** DATE 12-JAN-1999 ***** TIME 12:10 ***** P.1
(2)
MODE = RELAYED TRANSMISSION
(3)
REQUEST REC'V TIME=12-JAN 11:40 (6) START=12-JAN 12:00 (7) END=12-JAN 12:10
NUMBER OF PAGE(S) = 01 (4)
FILE NO. = 045 (5)

**** REQUESTING STATION ** (8)
- NEW YORK -
TELEPHONE NUMBER = 212 111 1234
NETWORK ADDRESS = 1000

(9) (10) (11) (12) (13)
NO. COMM. DESTINATION(S) PAGE(S) RLY STN

01 OK 2000 LONDON 001/001
02 OK 2001 STOCKHOLM 001/001
03 OK 2002 BERLIN 001/001
04 INC 2003 ROME 000/001

**RELAY STATION ** (14)
- LONDON-
TELEPHONE NUMBER = 44 71 111 1234
RELAY ADDRESS= 20
NETWORK ADDRESS= 2000

- LONDON -
*****- 44 71 111 1234 - *****
TOTAL P.01
    
```

6

Explanation of contents

- (1) Relay Station's Header Print
- (2) Indication of transmission mode
- (3) The time when the relay request was received
- (4) Number of pages received for a relay request
- (5) File number of the received relay request file
- (6) The time when the Relay Station starts sending Relay Faxes
- (7) The time when the Relay Station ends sending Relay Faxes
- (8) Initial Sending Station's information (LOGO, Telephone number and Network Address)
- (9) Communication number
- (10) Communication result : "OK" indicates that the transmission was successful.
"R-OK" indicates that the transmission to the Relay Station was successful.
"INC" indicates that the transmission was not completed.
- (11) Station name
- (12) Number of pages transmitted/number of pages received for a Relay Request
- (13) Another Relay Station's Relay Address/Network Address (If transferred to another Relay Station)
- (14) Relay Station's information (LOGO, Telephone number and Network Address)

Sub-addressing

General Description

The Sub-addressing function allows you further routing, forwarding or relaying of document(s) to the desired recipient(s) when used in combination with the Networking version of HydraFax/LaserFAX software. This function conforms to the ITU-T recommendation for T. Routing-Facsimile Routing utilizing the Sub-address.

Example of a Network

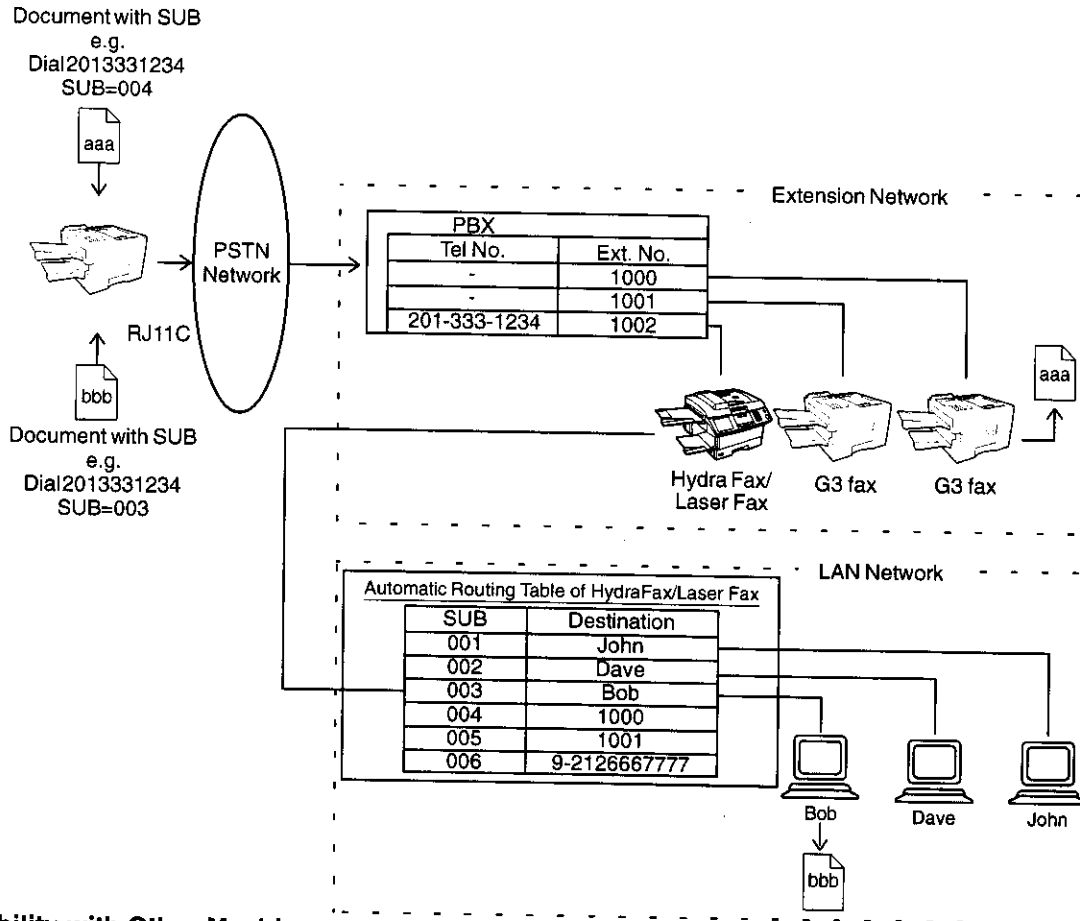

Compatibility with Other Machines

- Sub-addressing Transmission: DF-1100/UF-332/342/344/550/560/770/788/880/885/895 (see Note 2)
- Sub-addressing Reception: DF-1100/UF-342/344/550/560/770/788/880/885/895 with PC Interface using the Networking version of HydraFax/LaserFAX software.

Sub-addressing Transmission Methods

You can send a document with Sub-address information to the desired recipient by the following methods.

- By registering the Sub-address information into One-Touch/ABBR. Dialling Numbers.
- By specifying the Sub-address information in the Manual Number Dialing Mode.

Setting of Routing, Forwarding or Relaying

You can customize the Automatic Routing to any combination of LAN (Local Area Network), PSTN (Public Switched Telephone Network) or PBX Extension with HydraFax/LaserFAX Routing Table (please refer to the HydraFax/LaserFAX User Manual).

! Note:

1. HydraFax and LaserFAX are trademarks of Wordcraft International Ltd.
2. UF-788 with PC Interface Option or the Option ROM installed.

Sub-addressing ◀

To set the Sub-address into a One-Touch/ABBR. Dialling Numbers

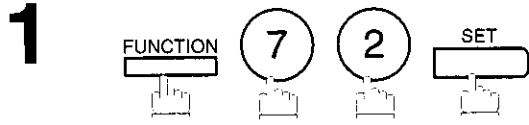

```
1: ONE-TOUCH
2: ABBR. NO.
```

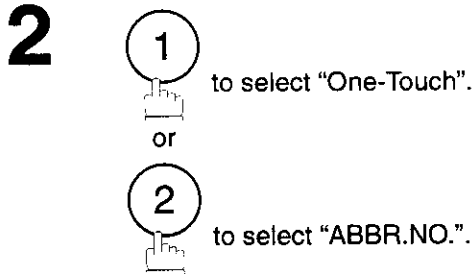

Ex: ①

```
ONE-TOUCH< >
PRESS ONE-TCH OR v ^
```



```
<01>
ENTER TEL. NO.
```

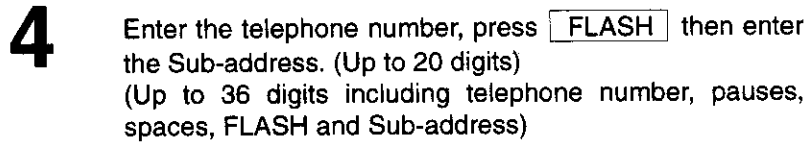

```
<01>
5551234s2762■
```

Ex: Telephone number = 5551234, Sub-address =2762

Enter as: ⑤⑤⑤①②③④,
FLASH ②⑦⑥②

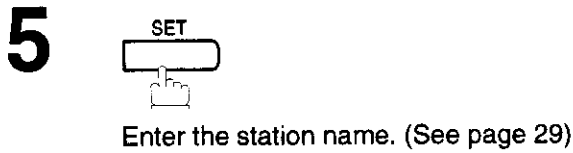

```
<01> SALES DEPT■
5551234s2762
```

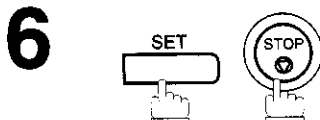

! Note:

1. **FLASH** separates the Sub-address from the Telephone number and is indicated by an "s" in the display.

6

Sub-addressing

To send a Document with Sub-address

Using One-Touch/ABBR. Number Dialling

The operation is the same as for normal dialling

1



Set document(s) face down.

```
ENTER STATION(S)  
THEN PRESS START 00%
```

2

Ex:

```
<01> (Station name)  
5551234s2762
```

3

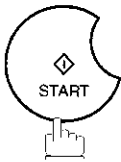

The document is stored into memory and your machine starts to dial the number of the station and sends the document(s) with Sub-addressing information.

```
* STORE * NO. 001  
PAGES=001 01%
```

Using Manual Number Dialling

Use to separate the Telephone number and the Sub-address.

1



Set document(s) face down.

```
ENTER STATION(S)  
THEN PRESS START 00%
```

2

Enter the telephone number, press then enter the Sub-address (up to 20 digits).
(Up to 36 digits including telephone number, pauses, spaces, FLASH and Sub-address)

```
TEL. NO.  
5551234s2762
```

Ex: Telephone number = 5551234, Sub-address=2762

Enter as: (5) (5) (5) (1) (2) (3) (4)

(2) (7) (6) (2)

3

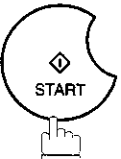

The document is stored into memory and your machine starts to dial the number of the station and sends the document(s) with Sub-addressing information.

```
* STORE * NO. 001  
PAGES=001 01%
```

! Note:







1. separates the Sub-address from the Telephone number and is indicated by an "s" in the display.
2. Manual Off-Hook or On-Hook Dialling cannot be used with the Sub-addressing Transmission.
3. The Sub-address is not transmitted during Manual Redial Mode.

Journals and Lists



To help you maintain records of the documents you sent and received, as well as lists of the numbers you record, your facsimile machine is equipped to print the following journals and lists: Transaction Journal, Individual Transmission Journal, Communication Journal, One-Touch/Abbreviated/Directory Search No. List, Program List, Fax Parameter List, Directory Sheet and File List.

Transaction Journal

The "Journal" is a record of the last 100 transactions (a transaction is recorded each time you send or receive a document). It is printed out automatically after every 100 transactions (See Note 1) or you can print or view it manually by using the following procedure:

- 1   PRINT OUT (1-7)
ENTER NO. OR v ^
- 2   JOURNAL
1:PRINT 2:VIEW
- 3a  for printing a Journal * PRINTING *
JOURNAL
- 3b  for viewing a Journal JOURNAL VIEW
1:XMT ONLY 2:ALL
- 4 Select the viewing mode.
 - ① to view transmission transactions only
 - ② to view all transactions

Ex: ②

You can view the transactions in the journal by pressing  or . Press STOP to return to standby.

USE THE v ^ KEYS TO
SCROLL EACH RECORD

7

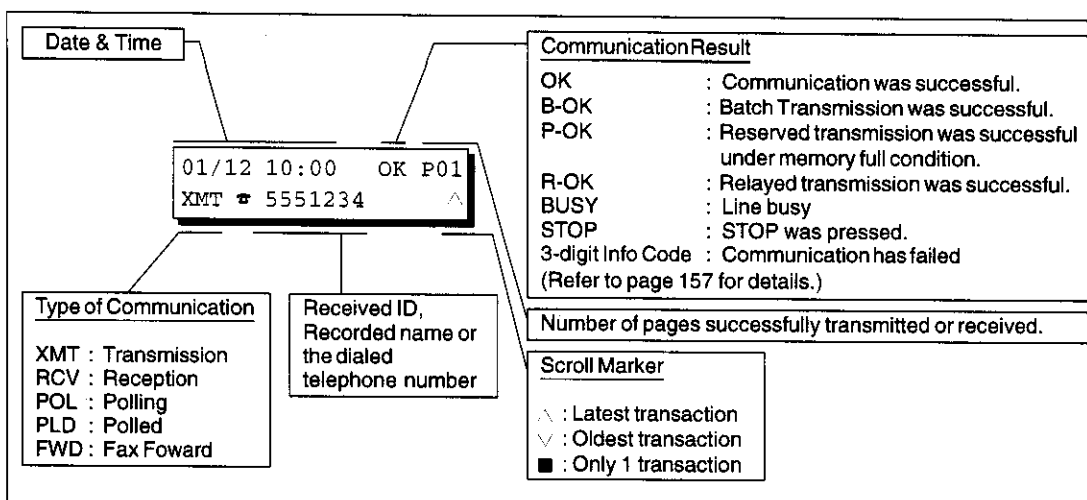

Note: 1. If you wish to disable the automatic print out of the Transaction Journal, change the setting of Fax Parameter No. 13 to "Invalid". (See page 35)

▶ Journals and Lists

Individual Transmission Journal (IND. XMT JOURNAL)

An Individual Transmission Journal contains the information on the latest transmission.

1

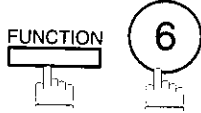

PRINT OUT (1-7)
ENTER NO. OR V ^

2



6: IND. XMT JOURNAL?
PRESS SET TO PRINT

3

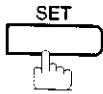

* PRINTING *
IND. XMT JOURNAL

Journals and Lists

Sample Transaction Journal

***** -JOURNAL- ***** (1) (2) DATE 12-JAN-1999 ***** TIME 15:00 *****									
(3)	(4)	(5)	(6)	(7)	(8)	(9)	(10)	(11)	(12)
NO.	COMM.	PAGES	FILE	DURATION	X/R	IDENTIFICATION	DATE	TIME	DIAGNOSTIC
01	B-OK	005/005		00:00:22	XMT	SERVICE DEPT.	11-JAN	17:35	C0044903C0000
		002/002	001						
		003/003	002						
02	OK	003	003	00:01:17	RCV	111 222 333	11-JAN	17:41	C0044903C0000
03	OK	001	004	00:00:31	XMT	ACCOUNTING DEPT.	11-JAN	17:50	C0044903C0000
04	630	000/005	005	00:00:00	XMT	☎342345676	11-JAN	17:57	0800420000000
05	STOP	000	006	00:00:34	XMT	☎12324567	11-JAN	18:35	0210260200000
06	OK	001/001	007	00:00:20	XMT	☎44567345	11-JAN	18:44	C8044B03C0000
07	408	*003	008	00:02:14	XMT	☎2345678	11-JAN	18:55	0040440A30080
48	OK	002/002	049	00:00:31	XMT	☎0245674533	12-JAN	08:35	C8044B03C1000
49	OK	003/003	050	00:01:32	XMT	☎0353678980	12-JAN	08:57	C8044B03C1000
(13) -PANASONIC									
***** -HEAD OFFICE - ***** (15) 201 555 1212- ***** (14)									

7
=

Sample Individual Transmission Journal (IND. XMT JOURNAL)

***** -IND. XMT JOURNAL- ***** (1) (2) DATE 12-JAN-1999 ***** TIME 15:00 *****		
(10) (11)	DATE/TIME	= 12-JAN-1999 09:00
(3)	JOURNAL No.	= 21
(4)	COMM. RESULT	= OK
(5)	PAGE(S)	= 001
(7)	DURATION	= 00:00:16
(6)	FILE No.	= 010
(16)	MODE	= TRANSMISSION
(17)	DESTINATION	= [001] / 555 1234 / ABCDEFG
(18)	RECEIVED ID	=
(19)	RESOLUTION	= STD
(13) -PANASONIC		
***** -HEAD OFFICE - ***** (15) 201 555 1212- ***** (14)		

Journals and Lists

Explanation of contents

- (1) Printout date
- (2) Printout time
- (3) Journal number
- (4) Communication result : "OK" indicates that the communication was successful.
"BUSY" indicates that the communication has failed because of busy line.
"STOP" indicates that **STOP** was pressed during communication.
"B-OK" indicates that the Batch Transmission was successful.
(All batched files are listed below the batched transaction.)
"M-OK" indicates that the substitute reception message in memory was not printed out.
"P-OK" indicates that memory overflow or document misfeeding occurred while storing the documents into memory for transmission but successfully stored document(s) was sent.
"R-OK" indicates that the Relayed XMT or Confidential Communication was successful.
"3-digit Info Code" (See page 155) indicates that the communication has failed.
- (5) Number of pages transmitted or received : The 3-digit number is the number of pages successfully transmitted or received. When the documents are stored into memory, two 3-digit numbers will appear. The first 3-digit number represents the number of pages successfully transmitted. The second 3-digit number represents the total number of pages that were attempted to be transmitted.
Asterisk "*" indicates that the quality of some received copies was poor.
- (6) File number : 001 to 999 (If the communication is stored into memory, a file number is assigned for each communication.)
- (7) Duration of communication
- (8) Type of communication : "XMT" means Transmission
"RCV" means Reception
"POL" means Polling
"PLD" means Polled
"FWD" means Fax Forward
- (9) Remote station identification : Name : Recorded name in One-Touch or ABBR. Numbers or remote station's Character ID.
☎ number : Dialed telephone number (PIN code will not be shown)
Number : Remote station's ID number.
- (10) Communication date
- (11) Communication Start time
- (12) Diagnostic : For service personnel only
- (13) Own LOGO : Up to 25 characters
- (14) Own ID number : Up to 20 digits
- (15) Own Character ID : Up to 16 characters
- (16) Type of communication : Transmission or memory transmission
- (17) Destination : If a One-Touch or ABBR was used for the transmission:
One-Touch or ABBR. No./Telephone Number/Recorded Name
If not : Telephone number
- (18) Received remote station's ID : Character ID or ID number
- (19) Resolution : "STD" means standard resolution
"FINE" means fine resolution
"S-FINE" means super fine resolution

Journals and Lists

Communication Journal (COMM. JOURNAL)

The Communication Journal (COMM. JOURNAL) lets you verify whether the transmission or polling was successful. You may select the printout condition (Off/Always/Inc. only) in Function 8-1 or Fax Parameter No. 12.

Sample COMM. JOURNAL

```
***** - COMM. JOURNAL - ***** DATE 12-JAN-1999 **** TIME 15:00 *****
(1)
MODE = MEMORY TRANSMISSION
(2)
START=12-JAN 14:50
(3)
END=12-JAN 15:00
FILE NO.= 050 (4)
(5) (6) (7) (8) (9) (10)
STN NO. COMM. ABBR NO. STATION NAME/TEL NO. PAGES DURATION
001 OK <01> SERVICE DEPT. 001/001 00:01:30
002 OK <02> SALES DEPT. 001/001 00:01:25
003 407 <03> ACCOUNTING DEPT. 000/001 00:01:45
004 BUSY ☐ 021 111 1234 000/001 00:00:00
- PANASONIC -
***** - HEAD OFFICE - ***** - 201 555 1212 - *****
THE SLEREXE COMPANY LIMITED
SAPORS LANE . BOOLE . DORSET . BH25 8ER
TELEPHONE BOOLE (945 13) 51617 - TELEX 123456
Our Ref. 350/PJC/EAC 18th January, 1972.
Dr. P.N. Cundall,
Mining Surveys Ltd
```

7

... variations of print density ...
cause the photocell to generate an analogous electrical video signal.
This signal is used to modulate a carrier, which is transmitted to a
remote destination over a radio or cable communications link.

At the remote terminal, demodulation reconstructs the video
signal, which is used to modulate the density of print produced by a
printing device. This device is scanning in a raster scan synchronised
with that at the transmitting terminal. As a result, a facsimile
copy of the subject document is produced.

Probably you have uses for this facility in your organisation.

Yours sincerely,

Phil.

P.J. CROSS
Group Leader - Facsimile Research

▶ Journals and Lists

Explanation of contents

- (1) Indication of communication mode
- (2) Start time of communication
- (3) End time of communication
- (4) File number
 - : 001 to 999 (When the communication is stored into memory, a file number is assigned for each communication.)
 - : Sequential number of the Stations.
 - : "OK" indicates that the communication was successful.
 - "BUSY" indicates that the communication has failed because of busy line.
 - "STOP" indicates that **STOP** was pressed during communication.
 - "B-OK" indicates that the Batch Transmission was successful.
 - "M-OK" indicates that the substitute reception message in memory was not printed out.
 - "P-OK" indicates that memory overflow or document misfeeding occurred while storing the documents into memory for transmission but successfully stored document(s) was sent.
 - "R-OK" indicates that the Relayed XMT or Confidential Communication was successful.
 - "3-digit Info Code" (See page 155) indicates that the communication has failed. In this case, the machine will print out the attached report with first page of your document as shown on the previous page.
- (7) Abbreviated number or ☒ mark
 - : ☒ mark indicates dialed by direct number dial.
- (8) Recorded name in One-Touch, ABBR. or direct dialling number
- (9) Number of pages transmitted or received
 - : The 3-digit number is the number of pages successfully transmitted or received. When the documents are stored into memory, two 3-digit numbers will appear. The first 3-digit number represents the number of pages successfully transmitted. The second 3-digit number represents the total number of pages that were attempted to be transmitted.
- (10) Duration of Communication

Journals and Lists ◀

One-Touch/Abbreviated and Directory Search List

To print a One-Touch/Abbreviated Number and Directory Search List of the telephone numbers you have stored.

1

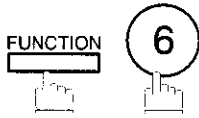

PRINT OUT (1-7)
ENTER NO. OR ∨ ^

2



2:ONE-TCH/ABBR LIST?
PRESS SET TO PRINT

3

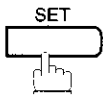

1:ONE-TOUCH/ABBR.NO.
2:DIR. SEARCH

4



for One-Touch/ABBR. Number List

* PRINTING *
ONE-TOUCH/ABBR. LIST



for Directory Search List

* PRINTING *
DIR. SEARCH LIST

7
=

Journals and Lists

Sample One-Touch List

```

***** -ONE-TOUCH LIST- ***** DATE 12-JAN-1999 ***** TIME 15:00 *****

(1)      (2)      (3)
ONE- STATION NAME TELEPHONE NO.
TOUCH

<01> SERVICE DEPT. 121 555 1234
<02> SALES DEPT. 222 666 2345
<03> ACCOUNTING DEPT 313 333 3456

NO. OF STATIONS = 03 (4)

(5) (6) (7) (8)
NETWORK RELAY RELAY ONE STN
ADRS STN. ADRS XMT

2000 YES 20 DIRECT
2001 NO 20 DIRECT
2002 NO 20 DIRECT

(see Note 1)

OWN TELEPHONE NO.=12345678 (9)
OWN NETWORK ADDRESS=1000 (10)
NETWORK PASSWORD=9999 (11)

(see Note 1)

-PANASONIC -

***** -HEAD OFFICE - ***** 201 555 1212- *****
  
```

Sample ABBR. Number List

```

***** -ABBR. NO. LIST- ***** DATE 12-JAN-1999 ***** TIME 15:00 *****

(1)      (2)      (3)
ABBR STATION NAME TELEPHONE NO.
NO.

[001] ENG. DEPT. 888 555 1234
[002] PURCHASE DEPT. 999 666 2345
[003] REGULATION DEPT 777 333 3456

NO. OF STATIONS = 003 (4)

(5) (6) (7) (8)
NETWORK RELAY RELAY ONE STN
ADRS STN. ADRS XMT

3000 YES 30 DIRECT
3001 NO 30 DIRECT
3002 NO 30 DIRECT

(see Note 1)

OWN TELEPHONE NO.=12345678 (9)
OWN NETWORK ADDRESS=1000 (10)
NETWORK PASSWORD=9999 (11)

(see Note 1)

-PANASONIC -

***** -HEAD OFFICE - ***** 201 555 1212- *****
  
```

Note:

- This information will be printed if the setting of Fax Parameter No.40 (RELAY XMT REQUEST) or No. 41 (CONF. FAX PARAMETER) is set to "Valid".

Journals and Lists

Sample Directory Search List

```

***** -DIR. SEARCH LIST- ***** DATE 12-JAN-1999 ***** TIME 15:00 *****

```

(12)	(2)	(1)	(3)	(5)	(6)	(7)	(8)
	STATION NAME	ABBR	TELEPHONE NUMBER	NETWORK	RELAY	RELAY	ONE STN
		NO.		ADRS	STN.	ADRS	XMT
[A]	ACCOUNTING DEPT	<03>	313 333 3456	2002	NO	20	DIRECT
[E]	ENG. DEPT.	[001]	888 555 1234	3000	YES	30	DIRECT
[P]	PURCHASE DEPT	[002]	555 666 2345	3001	NO	30	DIRECT
[R]	REGULATION DEPT	[003]	777 333 3456	3002	NO	30	DIRECT
[S]	SALES DEPT.	<01>	121 555 1234	2000	YES	20	DIRECT
	SERVICE DEPT	<02>	222 666 2345	2001	NO	20	DIRECT

(see Note 1)

NO. OF STATIONS = 006 (4)

OWN TELEPHONE NO. = 12345678 (9)
OWN NETWORK ADDRESS = 1000 (10)
NETWORK PASSWORD = 9999 (11)

(see Note 1)

-PANASONIC -

```

***** -HEAD OFFICE - ***** 201 555 1212 - *****

```

7

Explanation of contents

- | | |
|--|--|
| (1) One-Touch number or Abbreviated number | : <nn>= One-Touch number, [nnn] = Abbreviated number |
| (2) Station name recorded in the machine | : Up to 15 characters |
| (3) Telephone number recorded in the machine | : Up to 36 digits |
| (4) Number of recorded One-Touch and ABBR. numbers | |
| (5) Network Address | : 4-digit |
| (6) Relay Station | : Yes/No |
| (7) Relay Address | : 2-digit |
| (8) One Station XMT | : Relay/Direct |
| (9) Own telephone number | : Up to 36 digits |
| (10) Own Network Address | : 4-digit |
| (11) Network Password | : 4-digit |
| (12) The first letter of station name recorded in your machine | |

! **Note:** 1. This information will be printed if the setting of Fax Parameter No. 40 (RELAY XMT REQUEST) or No. 41 (CONF. FAX PARAMETER) is set to "Valid".

Journals and Lists

Program List

To print a Program List of the Dialling Patterns that you have previously entered into the Program Keys.

1

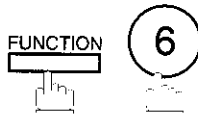

PRINT OUT (1-7)
ENTER NO. OR V ^

2



3:PROGRAM LIST?
PRESS SET TO PRINT

3

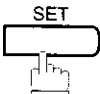

* PRINTING *
PROGRAM LIST

Sample Program List

```
***** -PROGRAM LIST- ***** DATE 12-JAN-1999 ***** TIME 15:00 *****
```

(1)	(2)	(3)	(4)	(5)
PROGRAM	PROGRAM NAME	TYPE	TIMER	ABBR. NOS.
[P1]	TIMER XMT	XMT	12:00	[001]
[P2]	TIMER POLL	POLL	19:00	[002]
[P3]	PROG. A	POLL	----	[001] [002]
[P8]	PROG. B	ABBR/GRP	----	[001] [002] [003]

-PANASONIC -

```
***** -HEAD OFFICE - ***** 201 555 1212- *****
```

Explanation of contents

- (1) Program key
- (2) Program name : Up to 15 characters
- (3) Type of communication : "XMT" indicates transmission.
"POLL" indicates polling.
"ABBR/GRP" indicates that the Program key is programmed as a group key.
"ONE-TOUCH" indicates that the Program key is programmed as a One-Touch key.
- (4) Timer : Indicates the starting time.
"----" indicates that the Program key contains "non-deferred" program.
- (5) Numbers recorded in the program : One-Touch/ABBR. numbers

FAX Parameter List

To print out a FAX Parameter List:



PRINT OUT (1-7)
ENTER NO. OR ∨ ^



4:FAX PARA. LIST?
PRESS SET TO PRINT

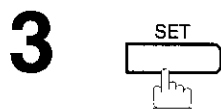

* PRINTING *
FAX PARAMETER LIST

7

Sample FAX Parameter List

```
***** -FAX PARAMETER LIST- ***** DATE 12-JAN-1999 ***** TIME 15:00 *****
```

(1) PARAMETER NUMBER	(2) DESCRIPTION	(3) SELECTION	(4) CURRENT SETTING	(5) STANDARD SETTING
01	CONTRAST (HOME)	(1:Normal 2:Lighter 3:Darker)	1	1
02	RESOLUTION (HOME)	(1:Standard 2:Fine 3:S-Fine)	2	1
04	STAMP (HOME)	(1:Off 2:On)	1	1
99	MEMORY SIZE		(2MB + 4MB)	(6)

-PANASONIC -

```
***** -HEAD OFFICE - ***** 201 555 1212- *****
```

Explanation of contents

- | | | |
|---|----------------------|---|
| (1) Parameter number | (4) Current setting | : "----" indicates code or password is not set. When the code or password is set, it is shown in parenthesis. |
| (2) Description : "(HOME)" means home position setting. | (5) Standard setting | : Factory preset standard setting |
| (3) Selection | (6) Memory sizes | : (Base memory + option memory) |

This page is intentionally left blank.

If You Have Any of These Problems

Mode	Symptom	Cause / Action	page
During Standby	The display is blinking	The battery is not installed or the battery is completely discharged. Install a New battery and reset the clock.	24
During Transmission	Document doesn't feed/multiple feed	1. Check that your document is free of staples and paper clips, and that it is not greasy or torn. 2. Check that your document is the right type to send through a fax machine by consulting the list on "Documents You Cannot Send". If your document has the characteristics listed, make a photocopy of your document and send the copy instead. 3. Check that the document is loaded properly. 4. Adjust the ADF Pressure.	39 40 162
	Document jam	The information code 031 will appear on the display if the document becomes jammed.	159
	Does not stamp	1. Check if Stamp LED is lit. 2. Check Fax parameter No. 04 and No. 28 settings.	42 35,36
	Stamp too light	Replace stamp or refill ink.	163
Transmission Copy Quality	Vertical lines on the transmitted document	Check own copy quality. If copy is OK, your machine has no problem, report to the receiving party that they have a problem. If copy is NG, clean the Document Scanning Area.	160
	Transmitted document is blank	1. Make sure the document is set face down. 2. Check own copy quality. If copy is OK, your machine has no problem, report to the receiving party that they have a problem. If copy is NG, clean the Document Scanning Area.	160
During Reception	No recording paper	The information code 010 will appear on the display if the paper runs out.	18
	Recording paper jam	The information code 001, 002, 003, 007 or 008 will appear on the display if the paper gets jammed.	157
	Recording paper doesn't advance into machine	Make sure that there is paper in the Paper Cassette. Follow the instructions for loading paper.	18
	Recording paper doesn't eject after printing	Check to see if the recording paper is jammed inside of the machine.	157
	Recording papers are not stacked in sequence. Machine does not print from the last page received.	1. Check if Fax Parameter No. 65 is set to valid. 2. If memory becomes full during reception, the machine will start to print from the 1st page received. We recommend that optional flash memory card is installed if this symptom occurs frequently.	38 171
	Document auto reduction doesn't work	Check Print Reduction settings.	61
	Out of toner	The information code 041 will appear on the display if the Toner Cartridge runs out of toner.	16

▶ Troubleshooting

Mode	Symptom	Cause / Action	page
Print Copy Quality	Vertical lines printing on the received document	Print out a Journal report (e.g. FUNCTION, 6, 1, SET and 1) and check quality to make sure whether your machine has trouble. If Journal report quality is OK, your machine has no problem, report to the sending party that they have a problem. If copy is NG, replace the Toner Cartridge.	141 16
	Fuzzy print	1. Make sure you are using the correct paper for the best possible print quality. 2. Try reversing the recording paper to the other side.	170
	Missing dots or lines/ inconsistent darkness within print	1. Make sure you are using the correct paper for the best possible print quality. 2. Replace the Toner Cartridge.	170 16
	Fading print	Your Toner Cartridge may be running out of toner. Replace the Toner Cartridge.	16
	Faint print	You may need to choose a different paper for the best possible print quality.	170
Communication	No dial tone	1. Check the connection of the telephone line. 2. Check the telephone line.	165
	No auto answer	1. Check the connection of the telephone line. 2. Check the Reception mode setting. 3. If the Fax Parameter No. 13 (AUTO JOURNAL PRINT) is set to "Valid" (default setting) and the machine is printing the received document from memory, which also happens to be the 100th transaction, the machine will not auto answer until the Transaction Journal completes printing.	165 60
	Cannot transmit or receive	An information code will be shown on the display. Refer to the information code table to find out the trouble.	155
No Unit Operation	No unit operation	To reset the machine, turn-off the Power Switch for a few seconds then turn it on again.	21

Information Codes

When something unusual occurs, the display may show one of the Information Codes listed below. These will help you to identify and correct the problem.

Info. Code	Meaning	Action	Page
001	Recording paper jammed when feeding from the 1st cassette.	Remove the jammed paper.	157
002	Recording paper jammed when feeding from the 2nd cassette.	Remove the jammed paper.	157
003	Recording paper jammed when feeding from the 3rd cassette.	Remove the jammed paper.	157
007	Recording paper did not completely exit out of machine.	Remove the Toner Cartridge and remove the jammed paper.	157
008	Paper cassette is opened while paper is feeding.	Remove the jammed paper and close the cassette.	157
010	No recording paper.	Load the recording paper.	18
011	Recording Paper Cassette is not installed properly.	Install the Recording Paper Cassette.	--
026	The backup battery is getting weak.	Replace the battery, otherwise, the clock contents may be lost.	164
030	Document is misfeeding.	1. Reload the document properly. 2. Remove the document jam. 3. Adjust ADF.	40 159 162
031	Document paper is too long or jammed. Document length exceeds 78.8 inches (2 meters).	1. Reload the document properly. 2. Remove document jam.	40 159
041	Out of toner.	Replace the Toner Cartridge.	16
043	Toner is getting low.		
045	Toner Cartridge is not installed.	Install the Toner Cartridge.	16
060	Printer Cover is open.	Close the Printer Cover.	--
061	ADF Door (Document Return Guide) is open.	Close the ADF Door.	--
063	Jam Access Cover (Optional 2nd Feeder Unit) is open.	Close the Jam Access Cover.	--
064	Jam Access Cover (Optional 3rd Feeder Unit) is open.	Close the Jam Access Cover.	--
400	During initial handshake, receiving station did not respond or communication error occurred.	1. Check with the other party. 2. Reload the document and send again.	--
401	Remote station required a Receiving Password to receive the document. Remote station does not have Confidential Mailbox.	Check the remote station.	--
402	During initial handshake, communication error occurred.	Reload the document and send again.	--

▶ Troubleshooting

Info. Code	Meaning	Action	Page
403	No polling capability at the remote side.	Ask remote side to set "POLLED=ON".	--
404/405	During initial handshake, communication error occurred.	Reload the document and send again.	--
406	Transmission Password does not match. Receiving Password does not match. Received from an unauthorized station in Selective Reception mode.	Check the password or the telephone number in One-Touch or Abbreviated station.	111 113 114
407	No confirmation from the receiving station for the previous page sent.	Wait a few minutes and send again.	--
408/409	Remote side confirmation of previous page is illegible.	Wait a few minutes and send again.	--
410	Communication aborted by the transmitting side.	Check with the other party.	--
411	Polling password does not match.	Check the polling password.	68
412	No data from the transmitting side.	Check with the other party.	--
414	Polling password does not match.	Check the polling password.	68
415	Polling transmission error.	Check the polling password.	68
416/417 418/419	Received data has too many errors.	Check with the other party.	--
420/421	Machine goes to receiving mode, but receives no command from the transmitting side.	1. Remote side misdial. 2. Check with the other party.	--
422/427	Interface is incompatible.	Check with the other party.	--
430/434	Communication error occurred while receiving.	Check with the other party.	--
436/490	Received data has too many errors.	Check with the other party.	--
456	<ul style="list-style-type: none"> • Unit received a confidential document or was requested to be polled of a confidential document under any of following conditions. <ol style="list-style-type: none"> 1) Not enough space in memory to receive the confidential document. 2) Confidential Mailbox is full. 3) While printing received document. • Unit was requested to relay a document. 	<ol style="list-style-type: none"> 1. Print a File List and check the contents. 2. Wait until unit finishes printing. 	77
492/493 494	Communication error occurred while receiving.	Check with the other party.	--
495	Telephone line disconnected.	Check with the other party.	--
501/502	Communication error occurred using the internal V.34 Modem.	Check with the other party.	--

Troubleshooting ◀

Info. Code	Meaning	Action	Page
540/541 542 543/544	Communication error occurred while transmitting.	1. Reload the document and send again. 2. Check with the other party.	--
550	Telephone line disconnected.	Check with the other party.	--
552/553 554/555	Communication error occurred while receiving.	Check with the other party.	--
580	Sub-address transmission to a unit that has no Sub-address function.	Check the remote station.	138
581	Sub-address Password transmission to a unit that has no Password Sub-address function.	Check the remote station.	138
601	ADF Door was opened during ADF transmission.	Close the ADF Door and send again.	159
623	No document loaded on the ADF.	Reload the document and send again.	--
630	Redial was not successful due to a busy line.	Reload the document and send again.	--
631	During dialing, STOP was pressed.	Reload the document and send again.	--
634	Redial was not successful due to no response from the called station or wrong number dialed. Note: If busy tone was not detected, the machine will only redial once.	Check the telephone number and send again.	--
638	Power failure occurred during the communication.	Check the power cord and plug.	20
800 - 816 825	Parameter setting for Confidential Network or Relay communication is not properly set.	Verify your Confidential Network and Relay communication parameter settings.	124 128
870	Memory overflow occurred while storing documents into memory for transmission.	1. Transmit documents without storing into memory. 2. Install Optional Memory Card.	51 171

8



Note:

1. After identifying the problem and verifying the recommended action, if the information Codes keep reoccurring or for help on Information Codes that appear on your machine but are not listed above, please contact your local Panasonic Authorized Dealer.

Troubleshooting

If the recording paper becomes jammed in the machine, the display will show an Information Code 001, 002, 003, 007 or 008.

To clear the jam, Info. Code 001, 002, 003, 008

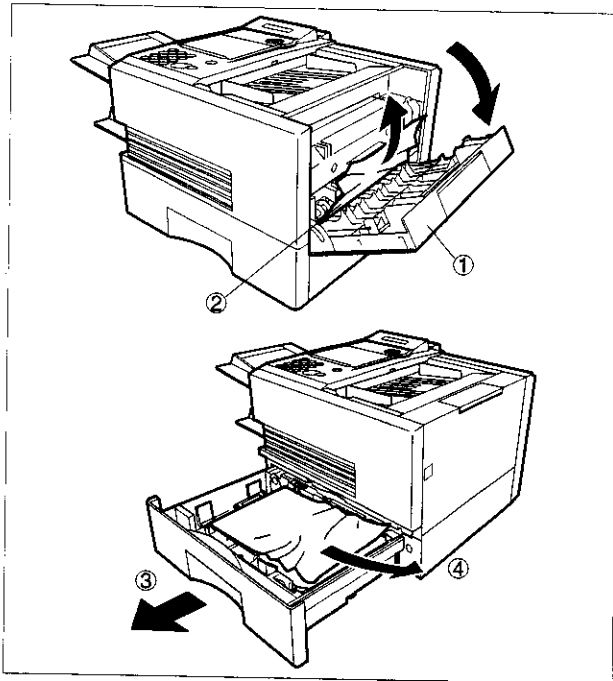

- (1) Open the Printer Cover.
- (2) Remove the jammed paper.
- (3) Slide out the Paper Cassette.
- (4) Remove the jammed or wrinkled paper and reload the recording paper into the paper cassette.

Caution: Make sure that the paper is set under the clips of the Paper Cassette. You can load about 500 sheets with standard weight paper (20 lb. or 75 g/m²). For paper specification see page 170.

To clear the jam, Info. Code 007

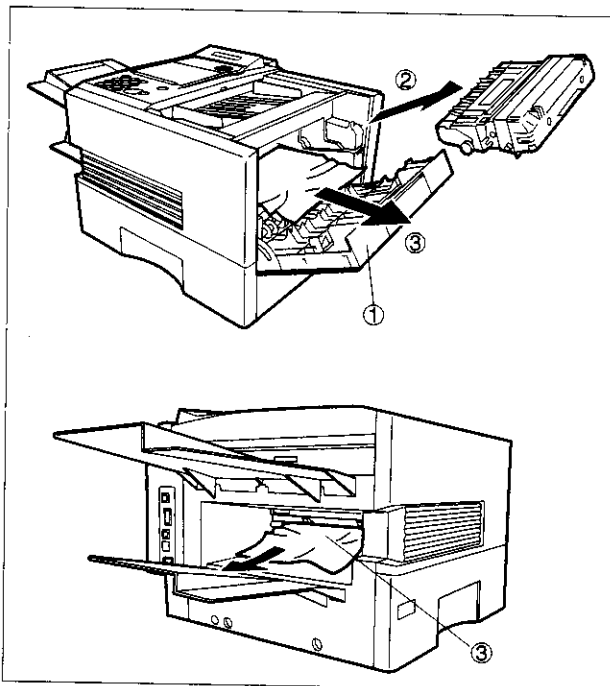

- (1) Open the Printer Cover.
- (2) Remove the Toner Cartridge.
- (3) Remove the jammed paper.

Note: If at all possible, try removing the jammed paper from inside of the unit first (as shown in the upper figure) to prevent toner that has not been fused on the paper from rubbing off and dirtying the Fuser Roller.



Note:

1. The Recording Paper Jam message display is reset only by opening and closing of the Printer Cover.

Clearing a Document Jam

If a document becomes jammed in the machine, the display will show the Information Code 030 or 031.

To clear the jam

1

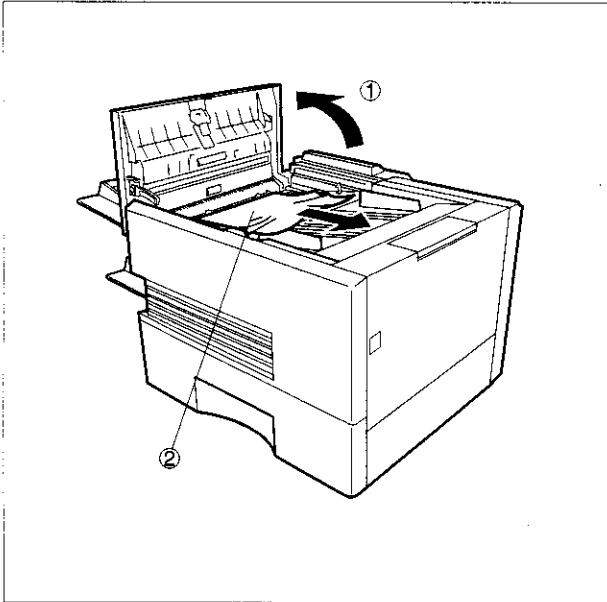

(1) Open the ADF Door.

(2) Remove the jammed document.

▶ Troubleshooting

Cleaning the Document Scanning Area

If the receiving party reports that the received documents were black, or contained black lines, try making a copy on your unit to verify. If the copy is black or has black lines, the document Scanning Area is probably dirty and must be cleaned.

To clean the Scanning Area

1

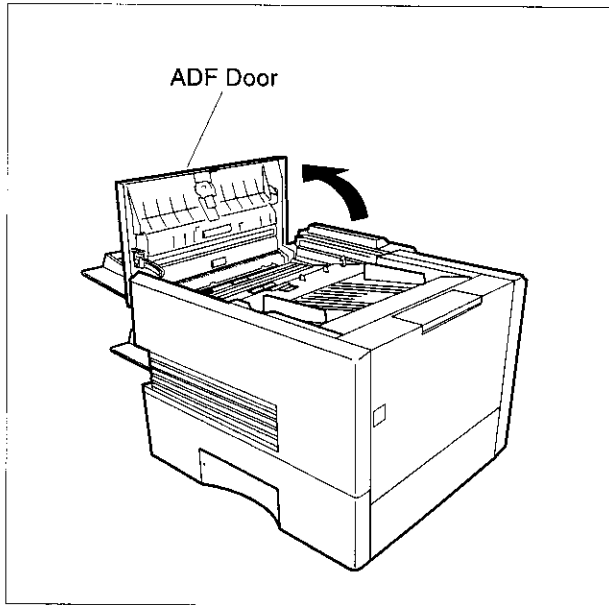

Open the ADF Door.

2

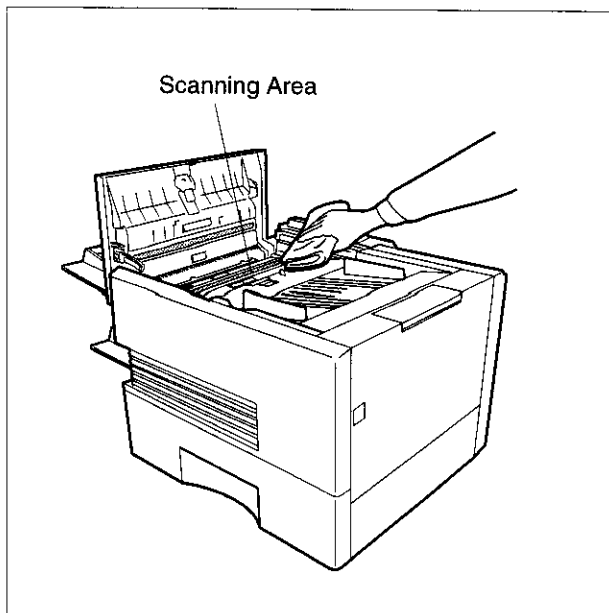

Wipe the Scanning Area gently with a soft cloth gauze wet with ethyl alcohol. Be sure to use a clean cloth, the scanning area can be easily scratched.

Cleaning the Printer Roller

If you find toner on the back of the recording paper, the printer roller in the fuser unit is probably dirty.

To clean the printer roller

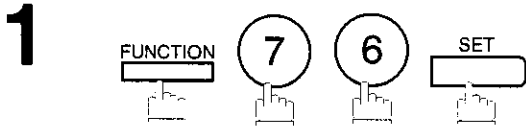

CLEANING CHARTS
1:PRINT 2:CLEAN

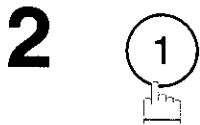

* PRINTING *
CLEANING CHARTS

The machine will print out 3 Cleaning Charts.
Then, return to standby.

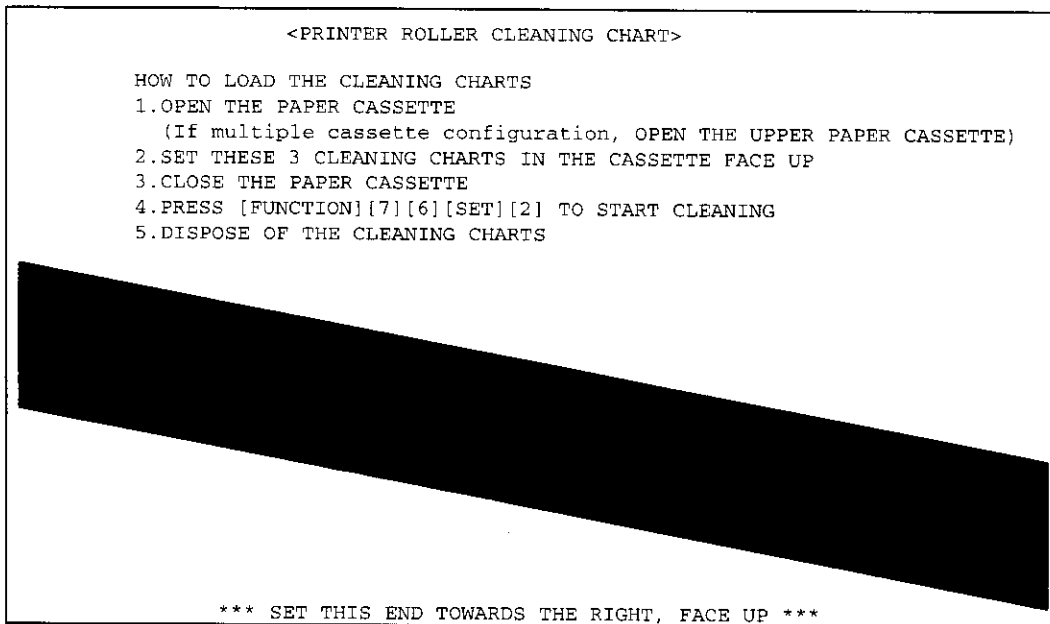

3 Load the Cleaning Charts into the cassette face up.
(See Note 1).

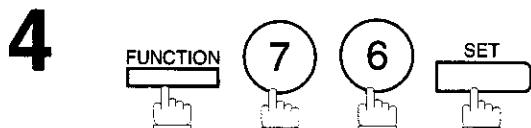

CLEANING CHARTS
1:PRINT 2:CLEAN



* CLEANING *
PRINTER ROLLER

The Machine will feed out the charts and clean the printer roller.

! **Note:** 1. If you have installed the optional cassette(s), load the Cleaning Charts into the upper cassette.

▶ Troubleshooting

Adjusting the Automatic Document Feeder (ADF)

If document misfeeding occurs frequently, we suggest you adjust the ADF.

To adjust the ADF,

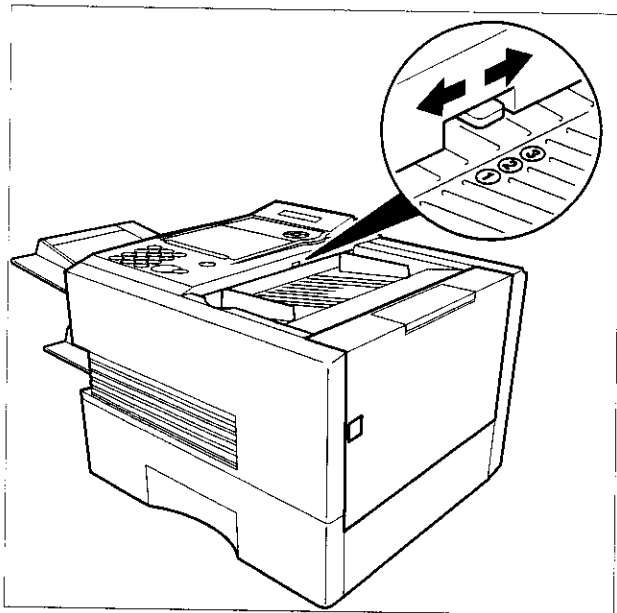

Pull the blue Pressure Adjusting Lever upward and slide it to the desired position depending on the condition.

Position	Condition
1	To prevent no feed trouble
2	Standard position
3	To prevent multiple feed trouble

Verification Stamp

The Verification Stamp contains ink. When the stamp mark appears faded or hard to see, the stamp should be replaced or refilled with ink.

To remove the stamp

1

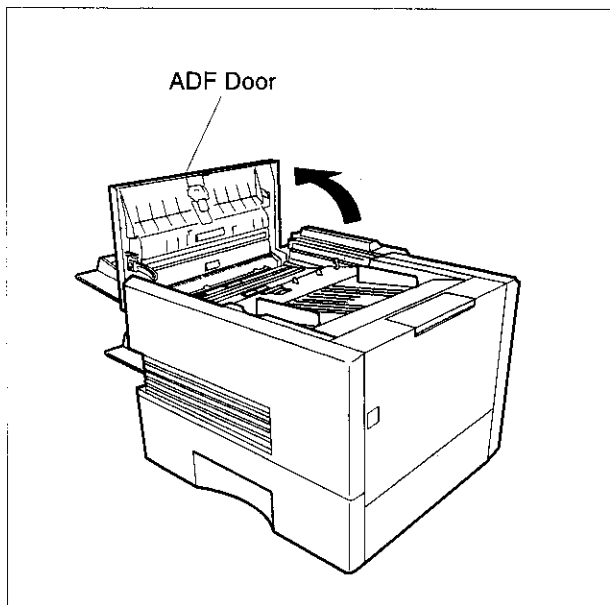

Open the ADF Door.

2

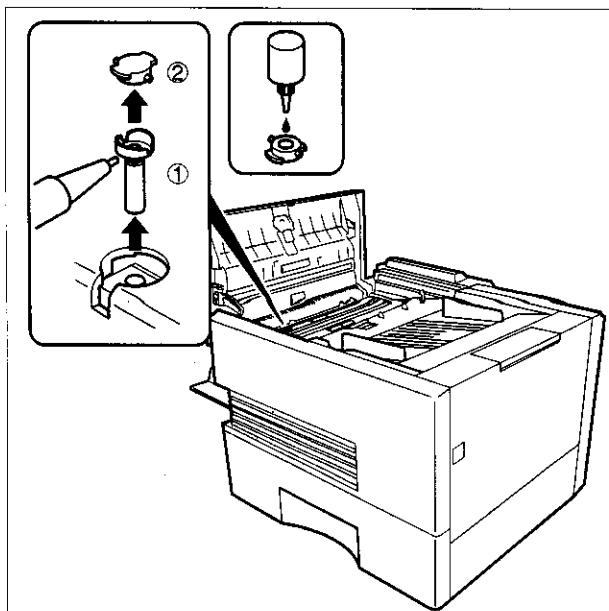

(1) Remove by pulling the Stamp Assembly upward.

(2) Remove the Stamp. Replace the stamp with a new one or refill the stamp with a few drops of the specified ink into the back of the stamp.



Note:

1. Please contact your local Panasonic dealer to purchase a new stamp. See page 172 for order number.

8

▶ Troubleshooting

Replacing the Lithium Battery

During the initial self test, when the power is turn "On", the machine will evaluate the condition of the back up battery. If the battery is weak or fully discharged, the following message will be shown on the display.

REPLACE BATTERY
INFO. CODE=026

To replace the battery, follow the procedure below:

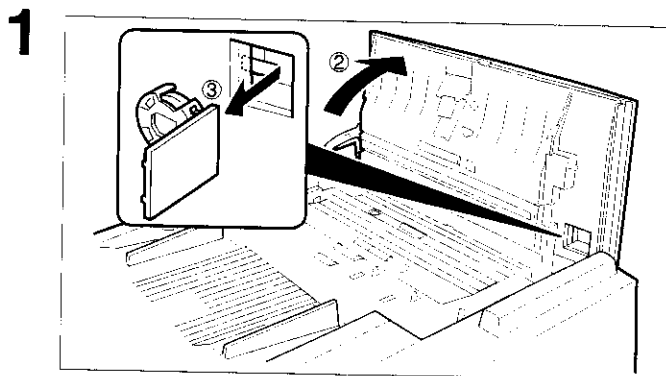

- (1) Turn the Power Switch to the "O" (OFF) position.
- (2) Open the ADF Door.
- (3) Remove the Battery together with the Battery Holder.

⚠ CAUTION

Dispose the Lithium battery properly and keep it away from small children.

Replace the Lithium Battery.
(Order No.: CR2032)

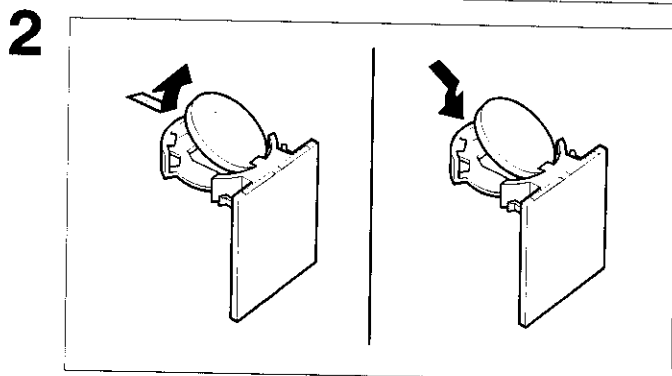

⚠ CAUTION

When replacing the battery make sure to observe the polarity to avoid damage to the machine.

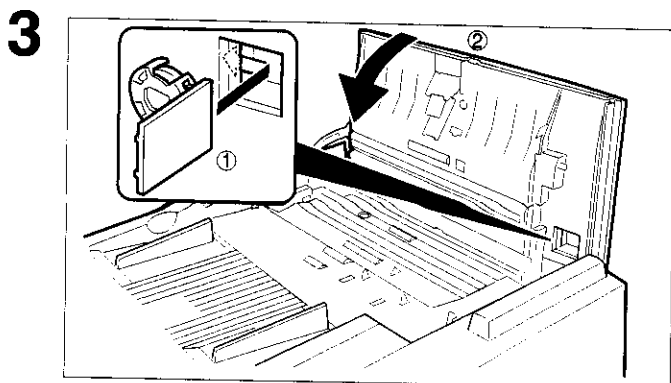

- (1) Install the Battery Holder into the machine.
- (2) Close the ADF Door.
- (3) Turn the Power Switch to the "I" (ON) position.

4 If the clock is flashing on the LCD Display, follow the procedure on page 24 to reset the clock.

! Note:

1. The service life of the battery is approximately 1 year when the machine is turned "Off".

Checking the Telephone Line

When you do not hear a dial tone through the telephone connected to the machine or when the telephone does not ring (No automatic receive).

1

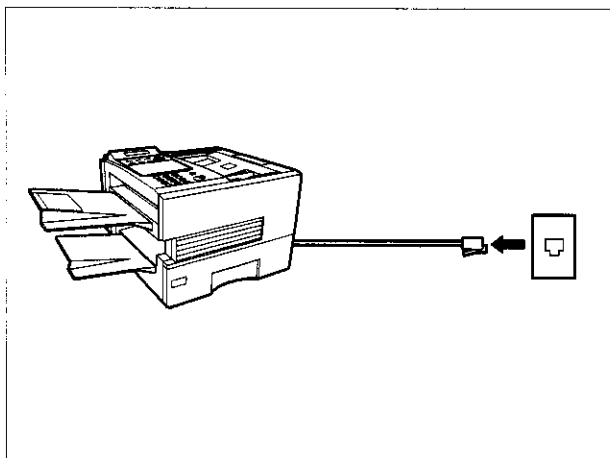

Unplug the Telephone Line Cable from the telephone jack that was supplied by the telephone company.

2

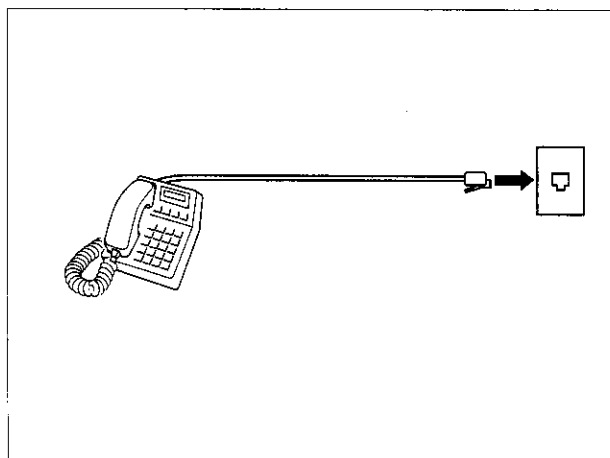

Plug a different regular telephone into the same telephone jack.

3

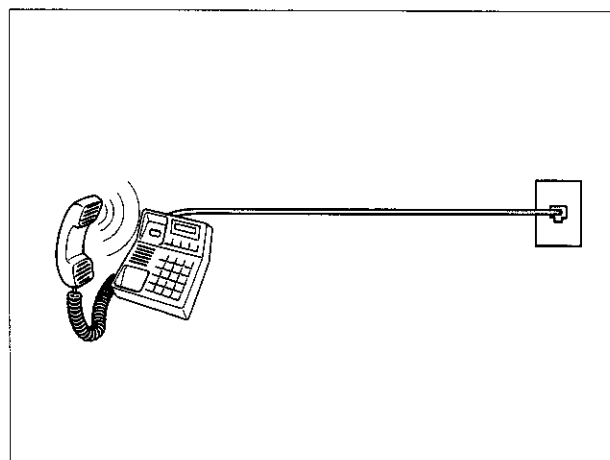

Check for dial tone through the handset. If there is still no dial tone, report it to your local telephone company.

or

Call from another telephone to this number. If the telephone does not ring, report it to your local telephone company.

8

This page is intentionally left blank.

Specifications ◀

Compatibility	ITU-T/CCITT Group 3
Coding Scheme	JBIG, MH, MR, MMR (Conforms to ITU-T/CCITT Recommendations)
Modem Type	ITU-T/CCITT V.34, V.17, V.33, V.29, V.27 ter and V.21
Modem Speed	33600 - 2400 bps
Document Size	Max. : 280 x 2000 mm (with operator's assistance) Min. : 148 x 128 mm
Document Thickness	Single page : 0.06 mm (45 g/m ²) to 0.15 mm (112 g/m ²) Multiple pages : 0.06 mm (45 g/m ²) to 0.12 mm (75 g/m ²)
ADF Capacity (Automatic Document Feeder)	Built-in, up to 50 pages
Scanning Method	Sheet Feeding with CCD type image sensor
Effective Scanning Width	9.9 in (252 mm)
Scanner Resolution	Horizontal : 8 pels/mm : Standard and Fine Resolution 16 pels/mm : Super Fine Resolution (Interpolated) Vertical : 3.85 lines/mm : Standard Resolution 7.7 lines/mm : Fine Resolution 15.4 lines/mm : Super Fine Resolution
Recording Method	Laser printer
Recording Paper	Plain Paper
Recording Paper Size	Letter, A4 or Legal
Printer Resolution (Fax/Copy)	406 × 391 dpi
(Printer)	300 × 300 dpi 600 × 600 dpi (Capable if an additional D-RAM Card is installed. The optimum size of the D-RAM Card depends on how you use the machine. Please ask your local Panasonic dealer for the details.)

Specifications

Effective Recording Size

Letter	: 208 x 271 mm
A4	: 202 x 289 mm
Legal	: 208 x 348 mm

Print Margin
(See Note 1)

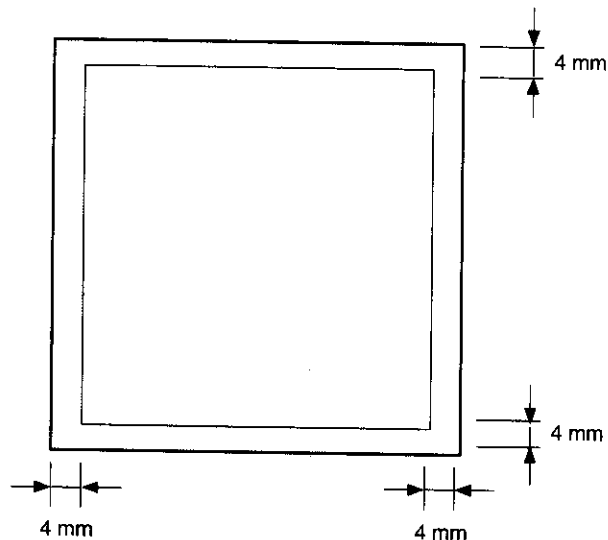

Recording Paper Capacity Approx. 500 sheets (using 20 lbs paper)

One-Touch/Abbreviated Dialing Memory Capacity 200 stations
(including 32 One-Touch keys and 8 Program keys)
Each station can register up to 36 digits for each telephone number (including pauses and spaces) and up to 15 characters for each station name

Image Memory Capacity

	UF-885	UF-895
Base Memory	60 pages	120 pages
with 1 MB Flash Memory Card	140 pages	200 pages
with 2 MB Flash Memory Card	220 pages	280 pages
with 4 MB Flash Memory Card	380 pages	440 pages
with 8 MB Flash Memory Card	700 pages	760 pages

(Based on ITU-T/CCITT Image No.1 using Standard Resolution)

- !** **Note:**
1. The left and right print margin is 5.5mm when printing a Letter or Legal size document with 600 dpi from a PC using the Parallel Port Interface Kit.

Specifications ◀

Power Supply	180-264 VAC, 47-63 Hz, Single Phase : 200 V Version (99-138 VAC, 47-63 Hz, Single Phase : 100 V Version)
Power Consumption	Standby : Approx. 1.3 Wh : 200 V Version (Sleep Mode : On) : Approx. 1.2 Wh : 100 V Version (Sleep Mode : On) : Approx. 10 Wh (Energy-Saver Mode : On) : Approx. 85 Wh (Energy-Saver Mode : Off) [Room temperature : 77°F (25°C)] Transmission: Approx. 23 W Reception : Approx. 460 W Copy : Approx. 470 W Max : Approx. 470 W
Dimensions	440 x 450 x 310 mm (excluding Projections and optional Paper Cassette)
Weight	Approx. 16 kg (excluding consumable supplies and options)
Operating Environment	Temperature : 10 to 35°C Relative Humidity : 15 to 70%

9
||

▶ Recording Paper Specifications

In general, most photocopy papers will also work very well. There are many "name" and "generic" brands of paper available. We recommend that you test various papers until you obtain the results you are looking for.

The following table summarizes the major specifications to consider when selecting white or colored paper.



Basic Weight	60 to 90 g/m ²
Cut Edge Conditions	Cut with sharp blades, no visible frayed edges
Grain	Long grain
Moisture Content	3.7% to 5.3% by weight
Opacity	88% minimum
Packing	Poly laminated moisture-proof ream wrap
Sizes	A4 : 210 mm x 297 mm Letter : 216 mm x 279 mm Legal : 216 mm x 356 mm
Type	Cut sheet (No curled)

-  **Note:**
1. It is possible that the paper could meet all of the specifications listed above and still not print well because of the variations in paper manufacturing. Therefore, we recommend that you test the paper thoroughly before purchasing.

Options and Supplies ◀

Please contact your local Panasonic dealer for availability.

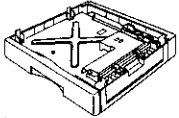
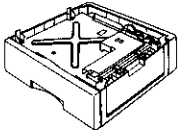
A. Options:

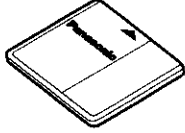
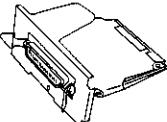
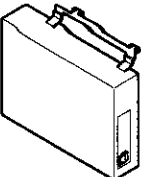
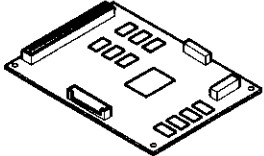
Order No.	Picture	Description	Available Models
UE-403160		Handset Kit	UF-885 UF-895
UE-409057		250 sheets Letter / Legal / A4 Size Paper Cassette with the Feeder Unit	UF-885 UF-895
UE-409056		500 sheets Letter / Legal / A4 Size Paper Cassette with the Feeder Unit	UF-885 UF-895
UE-410045		Expansion Flash Memory Card, 1 MB	UF-885 UF-895
UE-410046		Expansion Flash Memory Card, 2 MB	
UE-410047		Expansion Flash Memory Card, 4 MB	
UE-410048		Expansion Flash Memory Card, 8 MB	
UE-410033		Expansion D-RAM Card, 2MB	UF-885 UF-895
UE-410034		Expansion D-RAM Card, 4MB	
UE-410057		Expansion D-RAM Card, 8MB	
UE-403159		Parallel Port Interface Kit (Used for Printer or Scanner Interface) (Available in late Spring of 1999)	UF-885 UF-895
UE-407019		G3 Communication Port Kit (Available in late Spring of 1999) This option is NOT available together with the Page Description Language Printer Interface Kit (UE-403162).	UF-895
UE-403162		Page Description Language Printer Interface Kit (Available in late Summer of 1999) This option is NOT available together with the G3 Communication Port Kit (UE-407019).	UF-885 UF-895

- !** **Note:**
- Flash Memory Card is used for document storage.
D-RAM Memory Card is used to enhance the machine's overall performance and printing resolution.

► Options and Supplies

B. Supplies:

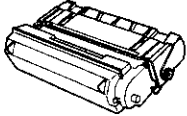
Order No.	Picture	Description	Available Models
FX-13-2P		Verification Stamp	UF-885 UF-895
UG-3313		Toner Cartridge	UF-885 UF-895

Installing the Memory Card (Flash Memory Card and / or DRAM Card)

Before installing, make sure that there is no document file(s) stored in the memory. You may confirm by printing out a File List (See page 77). When the memory card is installed, the machine will initialize the document memory, all contents stored in the document memory at that time will be lost.

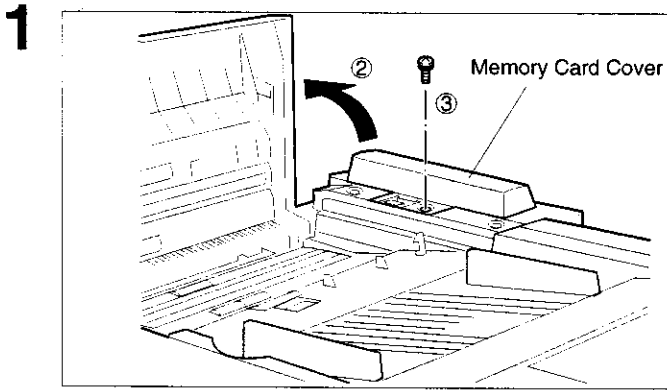

(1) Turn the Power Switch to the "O" (OFF) position located in the rear of the machine.

(2) Open the ADF Door.

(3) Remove a Screw.

(4) Remove the Memory Card Cover.

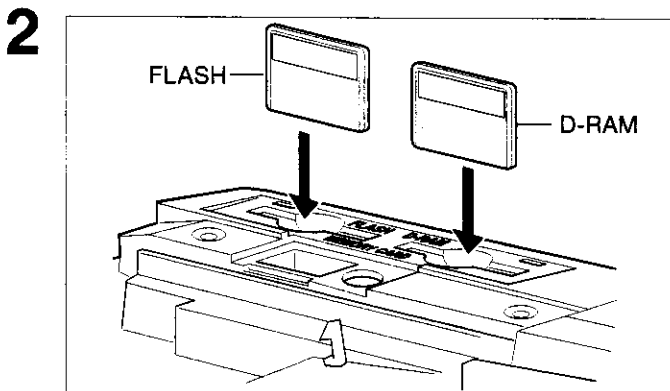

Insert the Memory Card(s) gently into the card slot with the Panasonic logo facing to the rear.

Caution: Installing the Memory Card(s) in the wrong direction may damage the connecting pins inside the machine.

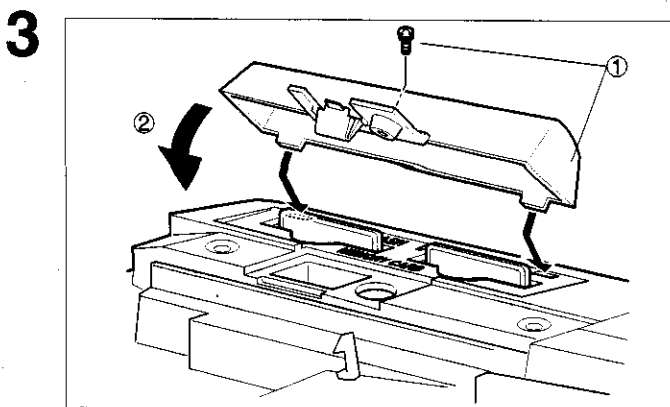

(1) Re-install the Memory Card Cover and the Screw to secure the Cover.

(2) Close the ADF Door.

4 Turn the Power Switch to the "I" (ON) position. Print out the Fax Parameter List (See page 151) and confirm that the memory size on Fax Parameter No. 99. (See page 38 and the Note 2 below)

! **Note:**

1. The document(s) stored in memory will be lost if the memory card is removed.
2. The memory size on Fax Parameter No.99 is only shown for the Flash Memory Card.

Glossary

ABBR. No. (Abbreviated Number)	The ability to store full phone numbers into the dialer and then utilizing a short series of keystrokes to speed dial that number in the future.
Access code	A 4-digit programmable access code that prevents unauthorized operation of your Fax.
ADF (Automatic Document Feeder)	The mechanism that delivers a stack of document pages to the scanner one page at a time.
Automatic reception	The mode that allows you to receive fax documents without user intervention.
Auto print reduction	The method of automatically reducing a received document so that it can be printed onto a standard size piece of plain paper. For example, your machine will reduce an incoming legal size page to 75% of its original size so it could fit on a letter size page.
BPS (Bits Per Second)	The amount of data that is transmitted over the phone line. Your machine can start at each Max. Modem speed and automatically steps down to suitable speed depending on the phone line condition and the receiving machines capabilities. (Max. Modem Speed 33600 BPS)
C.C.I.T.T.	Consultative Committee on International Telegraph and Telephone. This organization has presently developed four groups of industry standards that insure facsimile compatibility.
CCITT Image No.1 (ITU-T/CCITT)	An industry standard document that allows comparisons of the transmission speeds and capabilities of facsimile machines.
Character ID	A programmed proprietary code name that allows up to 16 alphanumeric characters identifying your facsimile machine.
Character keys	The keys that are used to enter letters and symbols for various programming functions.
Coding scheme	The data compression method used by facsimile machines. Your machine utilizes Modified Huffman (MH), Modified Read (MR), and Modified Modified Read (MMR) and Joint Bi-level Experts Group (JBIG) coding schemes.
COMM. JOURNAL	Refers to either the Communication Journal, Relay Transmission Report, or the Confidential XMT Report.
Confidential communication	In a network of facsimile machines, a code can be entered to retrieve a document that is stored in memory of a designated relay station.
Confidential XMT Report	The report that gives you information about the transmission of a confidential document(s) to a relay station.
CONTRAST	Signifies the scanning sensitivity in terms of lightness and darkness of your original transmitting pages.
Cover Sheet	A Fax Cover Sheet can be attached to your transmit document(s) that shows the recipient's name, originator's name and number of pages attached.

DDD (Direct Distance Dialling)	A telephone service that allows unassisted dialling, no operator assistance is required.
Deferred polling	The ability to retrieve documents from other stations at a later time.
Deferred transmission	The ability to send documents to other stations at a later time.
Department Code	This operation require the user to input a preset 4-digit Department Code before transmission. The Department Name of selected Department Code is printed on the Header of each page sent, Cover Sheet, COMM. Journal and Individual Transmission Journal.
Direct Dialling	The method of dialling where you enter the entire telephone number through the keypad.
Directory Search Dialling	Allows you to dial a full telephone number by searching the station's name entered in the One-Touch keys or Abbreviated dialling numbers.
Directory Sheet	The list that contains the station names that are programmed into your unit.
DTMF (Dual Tone Multi-Frequency)	Dialling method that sends a different set of frequencies for each digit of the telephone keypad. Commonly refers to touch tone Dialling.
ECM (Error Correction Mode)	The ability to correct transmission errors as detected during the transmitting phone call.
Energy-Saver Mode	Saves energy by consuming less power than when in standby mode by turning off the fuser unit after the specified time.
End receiving station	In a relay network, the final station designated to receive the document.
FAX Forward	The ability to forward all incoming faxes to the registered station.
FAX Parameter List	The list that contains the home FAX parameters settings that you have programmed into your machine.
File	A task that has been stored into the memory of your unit. Examples are deferred transactions.
File Transmission	A feature that allows you to store a perpetual File (until it is erased) in the memory that can be sent to a single or multiple stations repeatedly.
Fixed print reduction	The method that allows you to determine one reduction rate, such as 75%, for all incoming documents.
FUNCTION	The control panel key that will be utilized to begin an operation or configuration of a feature.
G3 mode (Group 3)	Refers to the standards and transmission capabilities of the current generation of facsimile machines.

Glossary

Group dialling	The ability to program many telephone numbers into a single station so that many locations can be dialed in sequence utilizing a single keystroke.
HALFTONE	A scanning technique to distinguish levels of gray from black and white. Your machine can detect up to 64 levels of gray in halftone mode.
Handshaking	The exchange of a group of control signals that communicate between the transmitter and receiver. These signals determine the condition at which communication can occur.
Header	A row of information that is transmitted by the sending machine and printed on the top of each page by the receiving unit. This identifies the transmitting unit and information about the transmission, such as time and date.
ITU-T	International Telecommunication Union - Telecommunication, formerly known as C.C.I.T.T.
ID	A programmable address of up to 20 digits identifying your machine.
Image memory capacity	This signifies the amount of memory available in your unit capable of storing pages of documents. All page units of measure are based on the ITU-T Image No.1.
Individual Transmission Journal	A report that is printed by the transmitting unit stating information regarding the last document transaction.
Information code	A code that is internally generated by your Fax stating a specific operational error or machine failure.
Initial sending station	In a relay network, the station that is originating the document transmission.
Journal	A report that is printed by your unit listing the last 100 transmitting and receiving transactions.
Keypad	A group of numeric keys located on your control panel.
LCD	Liquid Crystal Display. The display area of your machine.
LOGO	Your programmed company name or identification up to 25 alphanumeric characters.
Multiple Logo	The user can select one of 25 preset LOGOs before a transmission.
Manual reception	A mode that requires operator intervention to receive an incoming document.
Memory transmission	The documents are scanned into memory before actual connection to the phone line for transmission.
Modem	A device that converts signals from your fax machine into signals that can be transmitted over telephone lines.

Multi-station transmission	The ability to broadcast the same set of documents to a programmed number of locations.
Multi-file transmission	The ability to store many files into your machine's memory before actual telephone connection occurs.
Network address	An individual 4-digit addressing number assigned to a One-Touch/Abbreviated number that identifies a particular station in a relay network.
Network password	A 4-digit password assigned to a network address to prevent unauthorized stations from accessing a relay station.
Off-hook dialling	The direct dialling of a telephone number with the handset out of the cradle or "off the hook."
On-hook dialling	The direct dialling of a telephone number with the handset in the cradle or "on the hook."
One-Touch dialling	The ability to dial an entire telephone number by pressing one key.
Overlap Printing	Documents too long to be reduced are automatically printed on two pages with approximately 10 mm overlap.
Panasonic Super Smoothing	An electronic image enhancement (Panasonic Super Smoothing) that will create a particular pattern for the improvement of copy quality.
Polling	The ability to retrieve a document from another facsimile machine.
Polling password	A 4-digit programmed code that enables the security of a document being polled.
Power Failure Report	A report that contains information on the last transaction that took place during a power outage.
Power Saver Mode	To reduce the power consumption of the machine in standby, select the time period to turn OFF the high temperature fuser unit when the printer is idle.
Print Collation	The ability to stack received documents in the correct order.
Print reduction modes	The methods used to determine how an incoming document will be reduced to print onto the paper loaded in your machine.
Program keys	Keys that are defined for storing a sequence of stations to be dialed or polled.
Protocol	A protocol is the special set of rules for communicating that the end points in a telecommunication connection use when they send signals back and forth. Both end points must recognize and observe the protocol.
PSTN	Public Switched Telephone Network. Network of interconnected switching equipment and transmission facilities.
Receiving password	A 4-digit password that is checked before a document is received.

Glossary

Relay station	A certain type of facsimile machine that can store and forward documents to an end receiving station and/or a relay station in another relay network. Your machine can not be used as a relay station.
Relay network	A group of facsimile machines that communicate via a relay station.
Relay Transmission	Sending a document to a relay station, which in turn, sends the document to the end receiving station.
Relay Transmission Report	A report that contains information regarding the last document transmission to a relay station.
Relay address	A 2-digit code that identifies your machine is programmed in a relay network.
RESOLUTION	Relates to the number of dots scanned or printed per certain square. The quality of the image increases as the number of dots per certain square increases.
Sleep Mode	The lowest power state that the machine enters after the specified time without actually turning off. (Sleep Mode is not available when the optional Parallel Port Interface Kit, Page Description Language Printer Interface Kit or G3 Communication Port Kit is installed)
Selective reception	A function that can be set so that your unit will receive from only those machines programmed into your dialer.
Station name	Alphanumeric ID which can be programmed for each One-Touch dialling and Abbreviated dialling number.
Stored documents	Documents that have been scanned and now are stored in your machine's memory.
Sub-address	ITU-T recommendation for further routing, forwarding or relaying of incoming faxes.
Sub-address Password	ITU-T recommendation for additional security that corresponds to the Sub-address.
Substitute memory reception	Your machine's ability to store an incoming document into its memory, when it runs out of recording paper or toner.
Transmission reservation	The ability to preset a telephone number so that you may reserve a transmission while your unit is performing another function.
Transmission password	A 4-digit password that is checked when a document is transmitted.
User parameter	Programmed parameters that provide information to other stations. Examples are logo, character ID, date and time.
Verification stamp	A user selectable transmission verification stamp can be placed on scanned documents that are successfully transmitted or stored in memory.
View Mode - File List	Allows you to view the brief contents of the memory files through the LCD display without having to print the Memory File List.
View Mode - Journal	Allows you to view the brief contents of the journal through the LCD display without having to print the journal.

INDEX

A	
ABBR. Number List.....	147, 148
Abbreviated Dialing Numbers	29
Access Code.....	85
ADF Capacity.....	167
Automatic Document Feeder	40
Automatic Reception.....	60
Automatic Reduction.....	61
B	
Batch Transmission	65
C	
Character ID.....	26
Character Key.....	12
Communication Journal (COMM. JOURNAL).....	43, 145
Confidential Code	117
Confidential Communication	117
Confidential Mailbox.....	117
Contrast	41
Copy.....	64
Cover Sheet.....	90
D	
Date and Time	24
Deferred Polling	67
Deferred Transmission.....	66
Delayed Batch Transmission	65
Department Code.....	97
Diagnostic Password	37
Dialling Method (Tone or Pulse)	22
Dimensions	169
Direct Transmission	51
Direct Transmission Reservation	58
Directory Search Dialing	49, 54
Directory Sheet	33
Distinctive Ring Detector (DRD)	89
Document Jam.....	159
Document Misfeeding	162
Document Return Tray.....	14
Document Size.....	167
Document Thickness	167
E	
Edit File Mode	77
F	
Fax Forward.....	92
FAX Parameter List.....	151
Fax Parameter Table	35
FCC Registration Number.....	169
File List.....	77
File Transmission.....	93
Fixed Reduction	61
Function Key List.....	10
G	
Group Dialing	71
H	
Halftone.....	42
Header Format.....	35
Header Print.....	35
I	
ID Number.....	27
Image Memory Capacity	168
Incomplete File.....	36
IND. XMT JOURNAL.....	142
Information Codes.....	155
Initial Sending Station	128
J	
Journal	141
K	
Key/Buzzer Volume.....	35
L	
Loading Document	39
LOGO.....	25
M	
Memory Card	171, 173
Memory Transmission.....	44
Monitor Volume	23
Multiple LOGO	106
Multi-Station Transmission.....	50
N	
Network Address.....	131
Network Password	131
O	
Off-Hook Dialing	55
One-Touch Dialing Numbers.....	29
One-Touch Keys	29
One-Touch List.....	147, 148
On-Hook Dialing	56
Operating Environment	169
Overlap Printing	62
Own Network Address	131
Own Telephone Number.....	131
P	
Paper Specifications	170

Password Reception	112
Password Transmission	112
Pause	13
Polling	68
Polling Password.....	68
Power Consumption.....	169
Pressure Adjusting Lever.....	162
Print Collation.....	63
Print Margin.....	168
Print Reduction.....	61
Print Reduction Ratio	61
Priority Transmission Reservation	58
Program Keys	71
Program List.....	150

R

Real-time Batch Transmission	65
Receive To Memory	87
Received Time Print.....	35
Receiving Password.....	114
Recording Paper Jam	158
Redial	59
Reduction Ratio.....	36
Relay Address.....	131
Relay Network.....	128
Relay Station.....	128
Relay Station Parameter.....	131
Relay XMT Report (COMM. JOURNAL).....	136
Resolution	41
Result Report	136
Retry an Incomplete File	84
Ringer Equivalence	169
Ringer Volume	23

S

Scanner Resolution.....	167
Selective Reception	111
Sub-address Password.....	37
Sub-addressing	138
Substitute Memory Reception.....	63

T

Toner Cartridge	16
Transmission Password.....	113
Transmission Reservation.....	57

U

User Parameter.....	24
---------------------	----

V

Verification Stamp	42, 163
View Mode - File List.....	78

W

Weight.....	169
-------------	-----

Panafax®

Facsimile

UF-885

UF-895