



AMD64 Technology

AMD64 Architecture

Programmer's Manual

Volume 3:

General-Purpose and System Instructions

Publication No.	Revision	Date
24594	3.09	September 2003

© 2002, 2003 Advanced Micro Devices, Inc. All rights reserved.

The contents of this document are provided in connection with Advanced Micro Devices, Inc. ("AMD") products. AMD makes no representations or warranties with respect to the accuracy or completeness of the contents of this publication and reserves the right to make changes to specifications and product descriptions at any time without notice. No license, whether express, implied, arising by estoppel or otherwise, to any intellectual property rights is granted by this publication. Except as set forth in AMD's Standard Terms and Conditions of Sale, AMD assumes no liability whatsoever, and disclaims any express or implied warranty, relating to its products including, but not limited to, the implied warranty of merchantability, fitness for a particular purpose, or infringement of any intellectual property right.

AMD's products are not designed, intended, authorized or warranted for use as components in systems intended for surgical implant into the body, or in other applications intended to support or sustain life, or in any other application in which the failure of AMD's product could create a situation where personal injury, death, or severe property or environmental damage may occur. AMD reserves the right to discontinue or make changes to its products at any time without notice.

Trademarks

AMD, the AMD arrow logo, and combinations thereof, and 3DNow! are trademarks, and AMD-K6 is a registered trademark of Advanced Micro Devices, Inc.

MMX is a trademark and Pentium is a registered trademark of Intel Corporation.

Other product names used in this publication are for identification purposes only and may be trademarks of their respective companies.

Contents

Figures	ix
Tables	xi
Revision History	xiii
Preface	xv
About This Book	xv
Audience	xv
Contact Information	xv
Organization	xv
Definitions	xvi
Related Documents	xxvii
1 Instruction Formats	1
1.1 Instruction Byte Order	1
1.2 Instruction Prefixes	3
Summary of Legacy Prefixes	3
Operand-Size Override Prefix	5
Address-Size Override Prefix	6
Segment-Override Prefixes	9
Lock Prefix	10
Repeat Prefixes	10
REX Prefixes	14
1.3 Opcode	20
1.4 ModRM and SIB Bytes	20
1.5 Displacement Bytes	22
1.6 Immediate Bytes	23
1.7 RIP-Relative Addressing	23
Encoding	24
REX Prefix and RIP-Relative Addressing	24
Address-Size Prefix and RIP-Relative Addressing	25
2 Instruction Overview	27
2.1 Instruction Subsets	27
2.2 Reference-Page Format	28
2.3 Summary of Registers and Data Types	30
General-Purpose Instructions	30
System Instructions	33
128-Bit Media Instructions	35
64-Bit Media Instructions	38
x87 Floating-Point Instructions	40
2.4 Summary of Exceptions	41
2.5 Notation	43

	Mnemonic Syntax	43
	Opcode Syntax	46
	Pseudocode Definitions	48
3	General-Purpose Instruction Reference	59
	AAA	61
	AAD	62
	AAM	63
	AAS	64
	ADC	65
	ADD	67
	AND	69
	BOUND	72
	BSF	74
	BSR	76
	BSWAP	78
	BT	79
	BTC	81
	BTR	83
	BTS	85
	CALL (Near)	87
	CALL (Far)	89
	CBW	
	CWDE	
	CDQE	96
	CWD	
	CDQ	
	CQO	97
	CLC	98
	CLD	99
	CLFLUSH	100
	CMC	102
	CMOV _{cc}	103
	CMP	107
	CMPS _x	110
	CMPXCHG	113
	CMPXCHG8B	115
	CPUID	117
	DAA	132
	DAS	133
	DEC	134
	DIV	136
	ENTER	138
	IDIV	140
	IMUL	142
	IN	145
	INC	147
	INS _x	149

INT	152
INTO	160
Jcc	161
JCXZ	
JECXZ	
JRCXZ	165
JMP (Near)	167
JMP (Far)	169
LAHF	174
LDS	
LES	
LFS	
LGS	
LSS	175
LEA	178
LEAVE	180
LFENCE	182
LODSx	183
LOOPcc	185
MFENCE	187
MOV	188
MOVD	192
MOVMSKPD	195
MOVMSKPS	197
MOVNTI	199
MOVS	
MOVSB	
MOVSW	
MOVSD	
MOVSQ	201
MOVSX	203
MOVSLD	204
MOVZX	205
MUL	206
NEG	208
NOP	210
NOT	211
OR	212
OUT	215
OUTSx	217
POP	219
POPAX	222
POPFx	223
PREFETCHx	226
PREFETCHlevel	228
PUSH	230
PUSHAX	232

PUSHF _x	233
RCL	235
RCR	238
RET (Near)	241
RET (Far)	243
ROL	247
ROR	249
SAHF	251
SAL	
SHL	252
SAR	255
SBB	258
SCAS _x	261
SET _{cc}	263
SFENCE	266
SHL	267
SHLD	268
SHR	270
SHRD	272
STC	274
STD	275
STOS _x	276
SUB	278
TEST	281
XADD	283
XCHG	285
XLAT _x	287
XOR	289
4 System Instruction Reference	293
ARPL	294
CLI	296
CLTS	298
HLT	299
INT 3	300
INVD	303
INVLPG	304
IRET _x	305
LAR	311
LGDT	314
LIDT	316
LLDT	318
LMSW	320
LSL	321
LTR	323
MOV(CR _n)	325
MOV(DR _n)	327
RDMSR	329

	RDPMC	330
	RDTSC	331
	RSM	332
	SGDT	334
	SIDT	336
	SLDT	338
	SMSW	340
	STI	341
	STR	343
	SWAPGS	345
	SYSCALL	347
	SYSENTER	352
	SYSEXIT	354
	SYSRET	356
	UD2	360
	VERR	361
	VERW	363
	WBINVD	365
	WRMSR	366
Appendix A	Opcode and Operand Encodings	369
	A.1 Opcode-Syntax Notation	369
	A.2 Opcode Encodings	371
	One-Byte Opcodes	371
	Two-Byte Opcodes	374
	rFLAGS Condition Codes for Two-Byte Opcodes	380
	ModRM Extensions to One-Byte and Two-Byte Opcodes	381
	ModRM Extensions to SWAPGS and CLFLUSH Opcodes	384
	3DNow!™ Opcodes	384
	x87 Encodings	386
	rFLAGS Condition Codes for x87 Opcodes	395
	A.3 Operand Encodings	395
	ModRM Operand References	395
	SIB Operand References	401
Appendix B	General-Purpose Instructions in 64-Bit Mode	405
	B.1 General Rules for 64-Bit Mode	405
	B.2 Operation and Operand Size in 64-Bit Mode	406
	B.3 Invalid and Reassigned Instructions in 64-Bit Mode	436
	B.4 Instructions with 64-Bit Default Operand Size	437
	B.5 Single-Byte INC and DEC Instructions in 64-Bit Mode	439
	B.6 NOP in 64-Bit Mode	439
	B.7 Segment Override Prefixes in 64-Bit Mode	440
Appendix C	Differences Between Long Mode and Legacy Mode	441
Appendix D	Instruction Subsets and CPUID Feature Sets	443
	D.1 Instruction Subsets	443
	D.2 CPUID Feature Sets	445

	D.3	Instruction List	447
Appendix E		Instruction Effects on RFLAGS	481
		Index	487

Figures

Figure 1-1. Instruction Byte-Order	1
Figure 1-2. Little-Endian Byte-Order of Instruction Stored in Memory	2
Figure 1-3. Encoding Examples of REX-Prefix R, X, and B Bits	18
Figure 1-4. ModRM-Byte Format	21
Figure 1-5. SIB-Byte Format	22
Figure 2-1. Format of Instruction-Detail Pages	29
Figure 2-2. General Registers in Legacy and Compatibility Modes	30
Figure 2-3. General Registers in 64-Bit Mode	31
Figure 2-4. Segment Registers	32
Figure 2-5. General-Purpose Data Types	33
Figure 2-6. System Registers	34
Figure 2-7. System Data Structures	35
Figure 2-8. 128-Bit Media Registers	36
Figure 2-9. 128-Bit Media Data Types	37
Figure 2-10. 64-Bit Media Registers	38
Figure 2-11. 64-Bit Media Data Types	39
Figure 2-12. x87 Registers	40
Figure 2-13. x87 Data Types	41
Figure 2-14. Syntax for Typical Two-Operand Instruction	43
Figure 3-1. Processor Signature (EAX Register)	119
Figure 3-2. Initial APIC ID, CLFLUSH Size, and Brand ID (EBX Register)	120
Figure 3-3. Advanced Power Management Features (EDX Register)	130
Figure 3-4. MOVD Instruction Operation	193
Figure A-1. ModRM-Byte Fields	381
Figure A-2. ModRM-Byte Format	396
Figure A-3. SIB Byte Format	402
Figure D-1. Instruction Subsets vs. CPUID Feature Sets	444

Tables

Table 1-1.	Legacy Instruction Prefixes	4
Table 1-2.	Operand-Size Overrides.	5
Table 1-3.	Address-Size Overrides	7
Table 1-4.	Pointer and Count Registers and the Address-Size Prefix	8
Table 1-5.	Segment-Override Prefixes.	9
Table 1-6.	REP Prefix Opcodes.	11
Table 1-7.	REPE and REPZ Prefix Opcodes	12
Table 1-8.	REPNE and REPNZ Prefix Opcodes	13
Table 1-9.	REX Instruction Prefixes	14
Table 1-10.	Instructions Not Requiring REX Size Prefix in 64-Bit Mode. .	15
Table 1-11.	REX Prefix-Byte Fields	16
Table 1-12.	Special REX Encodings for Registers	19
Table 1-13.	Encoding for RIP-Relative Addressing	24
Table 2-1.	Interrupt-Vector Source and Cause	42
Table 2-2.	+rb, +rw, +rd, and +rq Register Value.	47
Table 3-1.	Processor Vendor Return Values	118
Table 3-2.	Effective Family Computation	119
Table 3-3.	Effective Model Computation.	120
Table 3-4.	CPUID Standard Feature Support (Standard Function 1) . .	121
Table 3-5.	CPUID AMD Feature Support (Extended Function 8000_0001h).	124
Table 3-6.	Processor Name String Example	126
Table 3-7.	CPUID TLB Bits for 2-Mbyte and 4-Mbyte Pages	127
Table 3-8.	CPUID TLB Bits for 4-Kbyte Pages	127
Table 3-9.	CPUID L1 Data Cache Bits	127
Table 3-10.	CPUID L1 Instruction Cache Bits.	128
Table 3-11.	CPUID L2 TLB Bits for 2-Mbyte and 4-Mbyte Pages	128
Table 3-12.	CPUID L2 TLB Bits for 4-Kbyte Pages.	129
Table 3-13.	CPUID L2 Cache Bits.	129
Table 3-14.	CPUID Long-Mode Address Sizes.	130
Table 3-15.	Locality References for the Prefetch Instructions	229
Table A-1.	One-Byte Opcodes, Low Nibble 0–7h	372
Table A-2.	One-Byte Opcodes, Low Nibble 8–Fh.	373
Table A-3.	Second Byte of Two-Byte Opcodes, Low Nibble 0–7h.	374

Table A-4.	Second Byte of Two-Byte Opcodes, Low Nibble 8–Fh	377
Table A-5.	rFLAGS Condition Codes for CMOV _{cc} , J _{cc} , and SET _{cc}	380
Table A-6.	One-Byte and Two-Byte Opcode ModRM Extensions	382
Table A-7.	SWAPGS and xFENCE ModRM Extensions	384
Table A-8.	Immediate Byte for 3DNow! [™] Opcodes, Low Nibble 0–7h	385
Table A-9.	Immediate Byte for 3DNow! [™] Opcodes, Low Nibble 8–Fh	386
Table A-10.	x87 Opcodes and ModRM Extensions	387
Table A-11.	rFLAGS Condition Codes for FCMOV _{cc}	395
Table A-12.	ModRM Register References, 16-Bit Addressing	396
Table A-13.	ModRM Memory References, 16-Bit Addressing	397
Table A-14.	ModRM Register References, 32-Bit and 64-Bit Addressing	399
Table A-15.	ModRM Memory References, 32-Bit and 64-Bit Addressing	400
Table A-16.	SIB <i>base</i> Field References	402
Table A-17.	SIB Memory References	403
Table B-1.	Operations and Operands in 64-Bit Mode	407
Table B-2.	Invalid Instructions in 64-Bit Mode	436
Table B-3.	Reassigned Instructions in 64-Bit Mode	437
Table B-4.	Invalid Instructions in Long Mode	437
Table B-5.	Instructions Defaulting to 64-Bit Operand Size	438
Table C-1.	Differences Between Long Mode and Legacy Mode	441
Table D-1.	Instruction Subsets and CPUID Feature Sets	447
Table E-1.	Instruction Effects on RFLAGS	481

Revision History

Date	Revision	Description
September 2003	3.09	Corrected table of valid descriptor types for LAR and LSL instructions and made several minor formatting, stylistic and factual corrections. Clarified several technical definitions.
April 2003	3.08	Corrected description of the operation of flags for RCL, RCR, ROL, and ROR instructions. Clarified description of the MOVSD and IMUL instructions. Corrected operand specification for the STOS instruction. Corrected opcode of SETcc, Jcc, instructions. Added thermal control and thermal monitoring bits to CPUID instruction. Corrected exception tables for POPF, SFENCE, SUB, XLAT, IRET, LSL, MOV(CRn), SGDT/SIDT, SMSW, and STI instructions.. Corrected many small typos and incorporated branding terminology.

Preface

About This Book

This book is part of a multivolume work entitled the *AMD64 Architecture Programmer's Manual*. This table lists each volume and its order number.

Title	Order No.
Volume 1, <i>Application Programming</i>	24592
Volume 2, <i>System Programming</i>	24593
Volume 3, <i>General-Purpose and System Instructions</i>	24594
Volume 4, <i>128-Bit Media Instructions</i>	26568
Volume 5, <i>64-Bit Media and x87 Floating-Point Instructions</i>	26569

Audience

This volume (Volume 3) is intended for all programmers writing application or system software for a processor that implements the AMD64 architecture. Descriptions of general-purpose instructions assume an understanding of the application-level programming topics described in Volume 1. Descriptions of system instructions assume an understanding of the system-level programming topics described in Volume 2.

Contact Information

To submit questions or comments concerning this document, contact our technical documentation staff at AMD64.Feedback@amd.com.

Organization

Volumes 3, 4, and 5 describe the AMD64 architecture's instruction set in detail. Together, they cover each instruction's mnemonic syntax, opcodes, functions, affected flags, and possible exceptions.

The AMD64 instruction set is divided into five subsets:

- General-purpose instructions
- System instructions
- 128-bit media instructions
- 64-bit media instructions
- x87 floating-point instructions

Several instructions belong to—and are described identically in—multiple instruction subsets.

This volume describes the general-purpose and system instructions. The index at the end cross-references topics within this volume. For other topics relating to the AMD64 architecture, and for information on instructions in other subsets, see the tables of contents and indexes of the other volumes.

Definitions

Many of the following definitions assume an in-depth knowledge of the legacy x86 architecture. See “Related Documents” on page xxvii for descriptions of the legacy x86 architecture.

Terms and Notation

In addition to the notation described below, “Opcode-Syntax Notation” on page 369 describes notation relating specifically to opcodes.

1011b

A binary value—in this example, a 4-bit value.

F0EAh

A hexadecimal value—in this example a 2-byte value.

[1,2)

A range that includes the left-most value (in this case, 1) but excludes the right-most value (in this case, 2).

7–4

A bit range, from bit 7 to 4, inclusive. The high-order bit is shown first.

128-bit media instructions

Instructions that use the 128-bit XMM registers. These are a combination of the SSE and SSE2 instruction sets.

64-bit media instructions

Instructions that use the 64-bit MMX registers. These are primarily a combination of MMX™ and 3DNow!™ instruction sets, with some additional instructions from the SSE and SSE2 instruction sets.

16-bit mode

Legacy mode or compatibility mode in which a 16-bit address size is active. See *legacy mode* and *compatibility mode*.

32-bit mode

Legacy mode or compatibility mode in which a 32-bit address size is active. See *legacy mode* and *compatibility mode*.

64-bit mode

A submode of *long mode*. In 64-bit mode, the default address size is 64 bits and new features, such as register extensions, are supported for system and application software.

#GP(0)

Notation indicating a general-protection exception (#GP) with error code of 0.

absolute

Said of a displacement that references the base of a code segment rather than an instruction pointer. Contrast with *relative*.

biased exponent

The sum of a floating-point value's exponent and a constant bias for a particular floating-point data type. The bias makes the range of the biased exponent always positive, which allows reciprocation without overflow.

byte

Eight bits.

clear

To write a bit value of 0. Compare *set*.

compatibility mode

A submode of *long mode*. In compatibility mode, the default address size is 32 bits, and legacy 16-bit and 32-bit applications run without modification.

commit

To irreversibly write, in program order, an instruction's result to software-visible storage, such as a register (including flags), the data cache, an internal write buffer, or memory.

CPL

Current privilege level.

CR0–CR4

A register range, from register CR0 through CR4, inclusive, with the low-order register first.

CR0.PE = 1

Notation indicating that the PE bit of the CR0 register has a value of 1.

direct

Referencing a memory location whose address is included in the instruction's syntax as an immediate operand. The address may be an absolute or relative address. Compare *indirect*.

dirty data

Data held in the processor's caches or internal buffers that is more recent than the copy held in main memory.

displacement

A signed value that is added to the base of a segment (absolute addressing) or an instruction pointer (relative addressing). Same as *offset*.

doubleword

Two words, or four bytes, or 32 bits.

double quadword

Eight words, or 16 bytes, or 128 bits. Also called *octword*.

DS:rSI

The contents of a memory location whose segment address is in the DS register and whose offset relative to that segment is in the rSI register.

EFER.LME = 0

Notation indicating that the LME bit of the EFER register has a value of 0.

effective address size

The address size for the current instruction after accounting for the default address size and any address-size override prefix.

effective operand size

The operand size for the current instruction after accounting for the default operand size and any operand-size override prefix.

element

See *vector*.

exception

An abnormal condition that occurs as the result of executing an instruction. The processor's response to an exception depends on the type of the exception. For all exceptions except 128-bit media SIMD floating-point exceptions and x87 floating-point exceptions, control is transferred to the handler (or service routine) for that exception, as defined by the exception's vector. For floating-point exceptions defined by the IEEE 754 standard, there are both masked and unmasked responses. When unmasked, the exception handler is called, and when masked, a default response is provided instead of calling the handler.

FF /0

Notation indicating that FF is the first byte of an opcode, and a subopcode in the ModR/M byte has a value of 0.

flush

An often ambiguous term meaning (1) writeback, if modified, and invalidate, as in "flush the cache line," or (2) invalidate, as in "flush the pipeline," or (3) change a value, as in "flush to zero."

GDT

Global descriptor table.

IDT

Interrupt descriptor table.

IGN

Ignore. Field is ignored.

indirect

Referencing a memory location whose address is in a register or other memory location. The address may be an absolute or relative address. Compare *direct*.

IRB

The virtual-8086 mode interrupt-redirection bitmap.

IST

The long-mode interrupt-stack table.

IVT

The real-address mode interrupt-vector table.

LDT

Local descriptor table.

legacy x86

The legacy x86 architecture. See “Related Documents” on page xxvii for descriptions of the legacy x86 architecture.

legacy mode

An operating mode of the AMD64 architecture in which existing 16-bit and 32-bit applications and operating systems run without modification. A processor implementation of the AMD64 architecture can run in either *long mode* or *legacy mode*. Legacy mode has three submodes, *real mode*, *protected mode*, and *virtual-8086 mode*.

long mode

An operating mode unique to the AMD64 architecture. A processor implementation of the AMD64 architecture can run in either *long mode* or *legacy mode*. Long mode has two submodes, *64-bit mode* and *compatibility mode*.

lsb

Least-significant bit.

LSB

Least-significant byte.

main memory

Physical memory, such as RAM and ROM (but not cache memory) that is installed in a particular computer system.

mask

(1) A control bit that prevents the occurrence of a floating-point exception from invoking an exception-handling routine. (2) A field of bits used for a control purpose.

MBZ

Must be zero. If software attempts to set an MBZ bit to 1, a general-protection exception (#GP) occurs.

memory

Unless otherwise specified, *main memory*.

ModRM

A byte following an instruction opcode that specifies address calculation based on mode (Mod), register (R), and memory (M) variables.

moffset

A 16, 32, or 64-bit offset that specifies a memory operand directly, without using a ModRM or SIB byte.

msb

Most-significant bit.

MSB

Most-significant byte.

multimedia instructions

A combination of *128-bit media instructions* and *64-bit media instructions*.

octword

Same as *double quadword*.

offset

Same as *displacement*.

overflow

The condition in which a floating-point number is larger in magnitude than the largest, finite, positive or negative number that can be represented in the data-type format being used.

packed

See *vector*.

PAE

Physical-address extensions.

physical memory

Actual memory, consisting of *main memory* and cache.

probe

A check for an address in a processor's caches or internal buffers. *External probes* originate outside the processor, and *internal probes* originate within the processor.

protected mode

A submode of *legacy mode*.

quadword

Four words, or eight bytes, or 64 bits.

RAZ

Read as zero (0), regardless of what is written.

real-address mode

See *real mode*.

real mode

A short name for *real-address mode*, a submode of *legacy mode*.

relative

Referencing with a displacement (also called offset) from an instruction pointer rather than the base of a code segment. Contrast with *absolute*.

REX

An instruction prefix that specifies a 64-bit operand size and provides access to additional registers.

RIP-relative addressing

Addressing relative to the 64-bit RIP instruction pointer.

set

To write a bit value of 1. Compare *clear*.

SIB

A byte following an instruction opcode that specifies address calculation based on scale (S), index (I), and base (B).

SIMD

Single instruction, multiple data. See *vector*.

SSE

Streaming SIMD extensions instruction set. See *128-bit media instructions* and *64-bit media instructions*.

SSE2

Extensions to the SSE instruction set. See *128-bit media instructions* and *64-bit media instructions*.

sticky bit

A bit that is set or cleared by hardware and that remains in that state until explicitly changed by software.

TOP

The x87 top-of-stack pointer.

TPR

Task-priority register (CR8).

TSS

Task-state segment.

underflow

The condition in which a floating-point number is smaller in magnitude than the smallest nonzero, positive or negative number that can be represented in the data-type format being used.

vector

(1) A set of integer or floating-point values, called *elements*, that are packed into a single operand. Most of the 128-bit and 64-bit media instructions use vectors as operands.

Vectors are also called *packed* or *SIMD* (single-instruction multiple-data) operands.

(2) An index into an interrupt descriptor table (IDT), used to access exception handlers. Compare *exception*.

virtual-8086 mode

A submode of *legacy mode*.

word

Two bytes, or 16 bits.

x86

See *legacy x86*.

Registers

In the following list of registers, the names are used to refer either to a given register or to the contents of that register:

AH–DH

The high 8-bit AH, BH, CH, and DH registers. Compare *AL–DL*.

AL–DL

The low 8-bit AL, BL, CL, and DL registers. Compare *AH–DH*.

AL–r15B

The low 8-bit AL, BL, CL, DL, SIL, DIL, BPL, SPL, and R8B–R15B registers, available in 64-bit mode.

BP

Base pointer register.

CR_n

Control register number *n*.

CS

Code segment register.

eAX–eSP

The 16-bit AX, BX, CX, DX, DI, SI, BP, and SP registers or the 32-bit EAX, EBX, ECX, EDX, EDI, ESI, EBP, and ESP registers. Compare *rAX–rSP*.

EFER

Extended features enable register.

eFLAGS

16-bit or 32-bit flags register. Compare *rFLAGS*.

EFLAGS

32-bit (extended) flags register.

eIP

16-bit or 32-bit instruction-pointer register. Compare *rIP*.

EIP

32-bit (extended) instruction-pointer register.

FLAGS

16-bit flags register.

GDTR

Global descriptor table register.

GPRs

General-purpose registers. For the 16-bit data size, these are AX, BX, CX, DX, DI, SI, BP, and SP. For the 32-bit data size, these are EAX, EBX, ECX, EDX, EDI, ESI, EBP, and ESP. For the 64-bit data size, these include RAX, RBX, RCX, RDX, RDI, RSI, RBP, RSP, and R8–R15.

IDTR

Interrupt descriptor table register.

IP

16-bit instruction-pointer register.

LDTR

Local descriptor table register.

MSR

Model-specific register.

r8–r15

The 8-bit R8B–R15B registers, or the 16-bit R8W–R15W registers, or the 32-bit R8D–R15D registers, or the 64-bit R8–R15 registers.

rAX–rSP

The 16-bit AX, BX, CX, DX, DI, SI, BP, and SP registers, or the 32-bit EAX, EBX, ECX, EDX, EDI, ESI, EBP, and ESP registers, or the 64-bit RAX, RBX, RCX, RDX, RDI, RSI,

RBP, and RSP registers. Replace the placeholder *r* with nothing for 16-bit size, “E” for 32-bit size, or “R” for 64-bit size.

RAX

64-bit version of the EAX register.

RBP

64-bit version of the EBP register.

RBX

64-bit version of the EBX register.

RCX

64-bit version of the ECX register.

RDI

64-bit version of the EDI register.

RDX

64-bit version of the EDX register.

rFLAGS

16-bit, 32-bit, or 64-bit flags register. Compare *RFLAGS*.

RFLAGS

64-bit flags register. Compare *rFLAGS*.

rIP

16-bit, 32-bit, or 64-bit instruction-pointer register. Compare *RIP*.

RIP

64-bit instruction-pointer register.

RSI

64-bit version of the ESI register.

RSP

64-bit version of the ESP register.

SP

Stack pointer register.

SS

Stack segment register.

TPR

Task priority register, a new register introduced in the AMD64 architecture to speed interrupt management.

TR

Task register.

Endian Order

The x86 and AMD64 architectures address memory using little-endian byte-ordering. Multibyte values are stored with their least-significant byte at the lowest byte address, and they are illustrated with their least significant byte at the right side. Strings are illustrated in reverse order, because the addresses of their bytes increase from right to left.

Related Documents

- Peter Abel, *IBM PC Assembly Language and Programming*, Prentice-Hall, Englewood Cliffs, NJ, 1995.
- Rakesh Agarwal, *80x86 Architecture & Programming: Volume II*, Prentice-Hall, Englewood Cliffs, NJ, 1991.
- AMD, *AMD-K6™ MMX™ Enhanced Processor Multimedia Technology*, Sunnyvale, CA, 2000.
- AMD, *3DNow!™ Technology Manual*, Sunnyvale, CA, 2000.
- AMD, *AMD Extensions to the 3DNow!™ and MMX™ Instruction Sets*, Sunnyvale, CA, 2000.
- Don Anderson and Tom Shanley, *Pentium Processor System Architecture*, Addison-Wesley, New York, 1995.
- Nabajyoti Barkakati and Randall Hyde, *Microsoft Macro Assembler Bible*, Sams, Carmel, Indiana, 1992.
- Barry B. Brey, *8086/8088, 80286, 80386, and 80486 Assembly Language Programming*, Macmillan Publishing Co., New York, 1994.
- Barry B. Brey, *Programming the 80286, 80386, 80486, and Pentium Based Personal Computer*, Prentice-Hall, Englewood Cliffs, NJ, 1995.
- Ralf Brown and Jim Kyle, *PC Interrupts*, Addison-Wesley, New York, 1994.
- Penn Brumm and Don Brumm, *80386/80486 Assembly Language Programming*, Windcrest McGraw-Hill, 1993.
- Geoff Chappell, *DOS Internals*, Addison-Wesley, New York, 1994.

- Chips and Technologies, Inc. *Super386 DX Programmer's Reference Manual*, Chips and Technologies, Inc., San Jose, 1992.
- John Crawford and Patrick Gelsinger, *Programming the 80386*, Sybex, San Francisco, 1987.
- Cyrix Corporation, *5x86 Processor BIOS Writer's Guide*, Cyrix Corporation, Richardson, TX, 1995.
- Cyrix Corporation, *M1 Processor Data Book*, Cyrix Corporation, Richardson, TX, 1996.
- Cyrix Corporation, *MX Processor MMX Extension Opcode Table*, Cyrix Corporation, Richardson, TX, 1996.
- Cyrix Corporation, *MX Processor Data Book*, Cyrix Corporation, Richardson, TX, 1997.
- Ray Duncan, *Extending DOS: A Programmer's Guide to Protected-Mode DOS*, Addison Wesley, NY, 1991.
- William B. Giles, *Assembly Language Programming for the Intel 80xxx Family*, Macmillan, New York, 1991.
- Frank van Gilluwe, *The Undocumented PC*, Addison-Wesley, New York, 1994.
- John L. Hennessy and David A. Patterson, *Computer Architecture*, Morgan Kaufmann Publishers, San Mateo, CA, 1996.
- Thom Hogan, *The Programmer's PC Sourcebook*, Microsoft Press, Redmond, WA, 1991.
- Hal Katircioglu, *Inside the 486, Pentium, and Pentium Pro*, Peer-to-Peer Communications, Menlo Park, CA, 1997.
- IBM Corporation, *486SLC Microprocessor Data Sheet*, IBM Corporation, Essex Junction, VT, 1993.
- IBM Corporation, *486SLC2 Microprocessor Data Sheet*, IBM Corporation, Essex Junction, VT, 1993.
- IBM Corporation, *80486DX2 Processor Floating Point Instructions*, IBM Corporation, Essex Junction, VT, 1995.
- IBM Corporation, *80486DX2 Processor BIOS Writer's Guide*, IBM Corporation, Essex Junction, VT, 1995.
- IBM Corporation, *Blue Lightning 486DX2 Data Book*, IBM Corporation, Essex Junction, VT, 1994.
- Institute of Electrical and Electronics Engineers, *IEEE Standard for Binary Floating-Point Arithmetic*, ANSI/IEEE Std 754-1985.

- Institute of Electrical and Electronics Engineers, *IEEE Standard for Radix-Independent Floating-Point Arithmetic*, ANSI/IEEE Std 854-1987.
- Muhammad Ali Mazidi and Janice Gillispie Mazidi, *80X86 IBM PC and Compatible Computers*, Prentice-Hall, Englewood Cliffs, NJ, 1997.
- Hans-Peter Messmer, *The Indispensable Pentium Book*, Addison-Wesley, New York, 1995.
- Karen Miller, *An Assembly Language Introduction to Computer Architecture: Using the Intel Pentium*, Oxford University Press, New York, 1999.
- Stephen Morse, Eric Isaacson, and Douglas Albert, *The 80386/387 Architecture*, John Wiley & Sons, New York, 1987.
- NexGen Inc., *Nx586 Processor Data Book*, NexGen Inc., Milpitas, CA, 1993.
- NexGen Inc., *Nx686 Processor Data Book*, NexGen Inc., Milpitas, CA, 1994.
- Bipin Patwardhan, *Introduction to the Streaming SIMD Extensions in the Pentium III*, www.x86.org/articles/sse_pt1/simd1.htm, June, 2000.
- Peter Norton, Peter Aitken, and Richard Wilton, *PC Programmer's Bible*, Microsoft Press, Redmond, WA, 1993.
- *PharLap 386\ASM Reference Manual*, Pharlap, Cambridge MA, 1993.
- *PharLap TNT DOS-Extender Reference Manual*, Pharlap, Cambridge MA, 1995.
- Sen-Cuo Ro and Sheau-Chuen Her, *i386/i486 Advanced Programming*, Van Nostrand Reinhold, New York, 1993.
- Jeffrey P. Royer, *Introduction to Protected Mode Programming*, course materials for an onsite class, 1992.
- Tom Shanley, *Protected Mode System Architecture*, Addison Wesley, NY, 1996.
- SGS-Thomson Corporation, *80486DX Processor SMM Programming Manual*, SGS-Thomson Corporation, 1995.
- Walter A. Triebel, *The 80386DX Microprocessor*, Prentice-Hall, Englewood Cliffs, NJ, 1992.
- John Wharton, *The Complete x86*, MicroDesign Resources, Sebastopol, California, 1994.
- Web sites and newsgroups:

- www.amd.com
- news.comp.arch
- news.comp.lang.asm.x86
- news.intel.microprocessors
- news.microsoft

1 Instruction Formats

The format of an instruction encodes its operation, as well as the locations of the instruction's initial operands and the result of the operation. This section describes the general format and parameters used by all instructions. For information on the specific format(s) for each instruction, see:

- Chapter 3, “General-Purpose Instruction Reference.”
- Chapter 4, “System Instruction Reference.”
- “128-Bit Media Instruction Reference” in Volume 4.
- “64-Bit Media Instruction Reference” in Volume 5.
- “x87 Floating-Point Instruction Reference” in Volume 5.

1.1 Instruction Byte Order

An instruction can be between one and 15 bytes in length. Figure 1-1 shows the byte order of the instruction format.

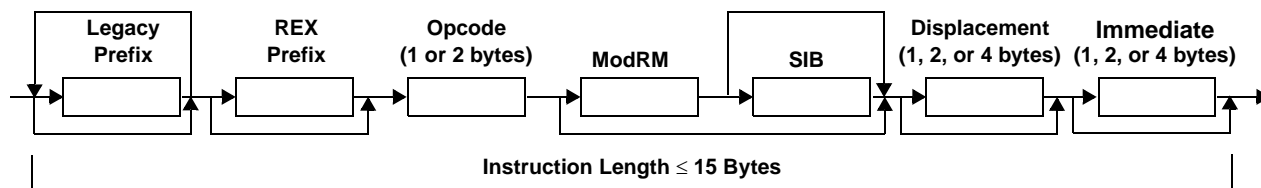
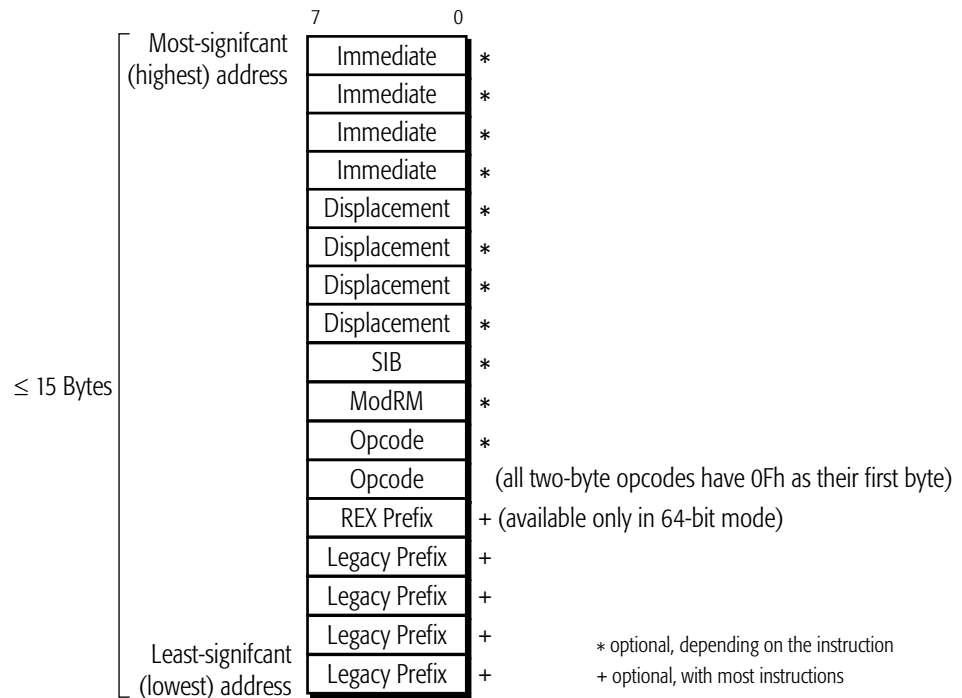

Figure 1-1. Instruction Byte-Order

Instructions are stored in memory in little-endian order. The least-significant byte of an instruction is stored at its lowest memory address, as shown in Figure 1-2 on page 2.



513-304.eps

Figure 1-2. Little-Endian Byte-Order of Instruction Stored in Memory

The basic operation of an instruction is specified by an *opcode*. The opcode is one or two bytes long, as described in “Opcode” on page 20. An opcode can be preceded by any number of *legacy prefixes*. These prefixes can be classified as belonging to any of the five groups of prefixes described in “Instruction Prefixes” on page 3. The legacy prefixes modify an instruction’s default address size, operand size, or segment, or they invoke a special function such as modification of the opcode, atomic bus-locking, or repetition. The *REX prefix* can be used in 64-bit mode to access the register extensions illustrated in “Application-Programming Register Set” in Volume 1. If a REX prefix is used, it must immediately precede the first opcode byte.

An instruction’s opcode consists of one or two bytes. In several 128-bit and 64-bit media instructions, a legacy operand-size or repeat prefix byte is used in a special-purpose way to modify the opcode. The opcode can be followed by a *mode-register-memory (ModRM) byte*, which further describes the operation

and/or operands. The opcode, or the opcode and ModRM byte, can also be followed by a *scale-index-base (SIB) byte*, which describes the scale, index, and base forms of memory addressing. The ModRM and SIB bytes are described in “ModRM and SIB Bytes” on page 20, but their legacy functions can be modified by the REX prefix (“Instruction Prefixes” on page 3).

The 15-byte instruction-length limit can only be exceeded by using redundant prefixes. If the limit is exceeded, a general-protection exception occurs.

1.2 Instruction Prefixes

The instruction prefixes shown in Figure 1-1 on page 1 are of two types: legacy prefixes and REX prefixes. Each of the legacy prefixes has a unique byte value. By contrast, the REX prefixes, which enable use of the AMD64 register extensions in 64-bit mode, are organized as a group of byte values in which the value of the prefix indicates the combination of register-extension features to be enabled.

1.2.1 Summary of Legacy Prefixes

Table 1-1 on page 4 shows the legacy prefixes—that is, all prefixes except the REX prefixes, which are described on page 14. The legacy prefixes are organized into five groups, as shown in the left-most column of Table 1-1. A single instruction should include a maximum of one prefix from each of the five groups. The legacy prefixes can appear in any order within the position shown in Figure 1-1 for legacy prefixes. The result of using multiple prefixes from a single group is unpredictable.

Some of the restrictions on legacy prefixes are:

- *Operand-Size Override*—This prefix affects only general-purpose instructions and a few x87 instructions. When used with 128-bit and 64-bit media instructions, this prefix acts in a special way to modify the opcode.
- *Address-Size Override*—This prefix affects only memory operands.
- *Segment Override*—In 64-bit mode, the CS, DS, ES, and SS segment override prefixes are ignored.
- *LOCK Prefix*—This prefix is allowed only with certain instructions that modify memory.

- **Repeat Prefixes**—These prefixes affect only certain string instructions. When used with 128-bit and 64-bit media instructions, these prefixes act in a special way to modify the opcode.

Table 1-1. Legacy Instruction Prefixes

Prefix Group ¹	Mnemonic	Prefix Byte (Hex)	Description
Operand-Size Override	none	66 ²	Changes the default operand size of a memory or register operand, as shown in Table 1-2 on page 5.
Address-Size Override	none	67 ³	Changes the default address size of a memory operand, as shown in Table 1-3 on page 7.
Segment Override	CS	2E ⁴	Forces use of the current CS segment for memory operands.
	DS	3E ⁴	Forces use of the current DS segment for memory operands.
	ES	26 ⁴	Forces use of the current ES segment for memory operands.
	FS	64	Forces use of the current FS segment for memory operands.
	GS	65	Forces use of the current GS segment for memory operands.
	SS	36 ⁴	Forces use of the current SS segment for memory operands.
Lock	LOCK	F0 ⁵	Causes certain kinds of memory read-modify-write instructions to occur atomically.
Repeat	REP	F3 ⁶	Repeats a string operation (INS, MOVS, OUTS, LODS, and STOS) until the rCX register equals 0.
	REPE or REPZ		Repeats a compare-string or scan-string operation (CMPSx and SCASx) until the rCX register equals 0 or the zero flag (ZF) is cleared to 0.
	REPNE or REPNZ	F2 ⁶	Repeats a compare-string or scan-string operation (CMPSx and SCASx) until the rCX register equals 0 or the zero flag (ZF) is set to 1.

Note:

1. A single instruction should include a maximum of one prefix from each of the five groups.
2. When used with 128-bit and 64-bit media instructions, this prefix acts in a special way to modify the opcode. The prefix is ignored by 64-bit media floating-point (3DNow!™) instructions. See "Instructions that Cannot Use the Operand-Size Prefix" on page 6.
3. This prefix also changes the size of the RCX register when used as an implied count register.
4. In 64-bit mode, the CS, DS, ES, and SS segment overrides are ignored.
5. The LOCK prefix should not be used for instructions other than those listed in "Lock Prefix" on page 10.
6. This prefix should be used only with compare-string and scan-string instructions. When used with 128-bit and 64-bit media instructions, the prefix acts in a special way to modify the opcode.

1.2.2 Operand-Size Override Prefix

The default operand size for an instruction is determined by a combination of its opcode, the D (default) bit in the current code-segment descriptor, and the current operating mode, as shown in Table 1-2. The operand-size override prefix (66h) selects the non-default operand size. The prefix can be used with any general-purpose instruction that accesses non-fixed-size operands in memory or general-purpose registers (GPRs), and it can also be used with the x87 FLDENV, FNSTENV, FNSAVE, and FRSTOR instructions.

In 64-bit mode, the prefix allows mixing of 16-bit, 32-bit, and 64-bit data on an instruction-by-instruction basis. In compatibility and legacy modes, the prefix allows mixing of 16-bit and 32-bit operands on an instruction-by-instruction basis.

Table 1-2. Operand-Size Overrides

Operating Mode		Default Operand Size (Bits)	Effective Operand Size (Bits)	Instruction Prefix ¹	
				66h	REX.W ³
Long Mode	64-Bit Mode	32 ²	64	don't care	yes
			32	no	no
			16	yes	no
	Compatibility Mode	32	32	no	Not Applicable
			16	yes	
		16	32	yes	
			16	no	
	Legacy Mode (Protected, Virtual-8086, or Real Mode)	32	32	no	
16			yes		
16		32	yes		
		16	no		

Note:

1. A "no" indicates that the default operand size is used.
2. This is the typical default, although some instructions default to other operand sizes. See Appendix B, "General-Purpose Instructions in 64-Bit Mode," for details.
3. See "REX Prefixes" on page 14.

In 64-bit mode, most instructions default to a 32-bit operand size. For these instructions, a REX prefix (page 16) can specify a 64-bit operand size, and a 66h prefix specifies a 16-bit operand size. The REX prefix takes precedence over the 66h prefix. However, if an instruction defaults to a 64-bit operand size, it does not need a REX prefix and it can only be overridden to a 16-bit operand size. It cannot be overridden to a 32-bit operand size, because there is no 32-bit operand-size override prefix in 64-bit mode. Two groups of instructions have a default 64-bit operand size in 64-bit mode:

- Near branches. For details, see “Near Branches in 64-Bit Mode” in Volume 1.
- All instructions, except far branches, that implicitly reference the RSP. For details, see “Stack Operation” in Volume 1.

Instructions that Cannot Use the Operand-Size Prefix. The operand-size prefix should be used only with general-purpose instructions and the x87 FLDENV, FNSTENV, FNSAVE, and FRSTOR instructions, in which the prefix selects between 16-bit and 32-bit operand size. The prefix is ignored by all other x87 instructions and by 64-bit media floating-point (3DNow!™) instructions.

When used with 64-bit media *integer* instructions, the 66h prefix acts in a special way to modify the opcode. This modification typically causes an access to an XMM register or 128-bit memory operand and thereby converts the 64-bit media instruction into its comparable 128-bit media instruction. The result of using an F2h or F3h repeat prefix along with a 66h prefix in 128-bit or 64-bit media instructions is unpredictable.

Operand-Size and REX Prefixes. The REX operand-size prefix takes precedence over the 66h prefix. See “REX.W: Operand Width” on page 16 for details.

1.2.3 Address-Size Override Prefix

The default address size for instructions that access non-stack memory is determined by the current operating mode, as shown in Table 1-3. The address-size override prefix (67h) selects the non-default address size. Depending on the operating mode, this prefix allows mixing of 16-bit and 32-bit, or of 32-bit and 64-bit addresses, on an instruction-by-instruction basis. The prefix changes the address size for memory operands. It also changes

the size of the RCX register for instructions that use RCX implicitly.

For instructions that implicitly access the stack segment (SS), the address size for stack accesses is determined by the D (default) bit in the stack-segment descriptor. In 64-bit mode, the D bit is ignored, and all stack references have a 64-bit address size. However, if an instruction accesses both stack and non-stack memory, the address size of the non-stack access is determined as shown in Table 1-3.

Table 1-3. Address-Size Overrides

Operating Mode		Default Address Size (Bits)	Effective Address Size (Bits)	Address-Size Prefix (67h) ¹ Required?
Long Mode	64-Bit Mode	64	64	no
			32	yes
	Compatibility Mode	32	32	no
			16	yes
			32	yes
			16	no
Legacy Mode (Protected, Virtual-8086, or Real Mode)	32	32	no	
		16	yes	
	16	32	yes	
		16	no	
Note:				
1. A “no” indicates that the default address size is used.				

As Table 1-3 shows, the default address size is 64 bits in 64-bit mode. The size can be overridden to 32 bits, but 16-bit addresses are not supported in 64-bit mode. In compatibility and legacy modes, the default address size is 16 bits or 32 bits, depending on the operating mode (see “Processor Initialization and Long-Mode Activation” in Volume 2 for details). In these modes, the address-size prefix selects the non-default size, but the 64-bit address size is not available.

Certain instructions reference pointer registers or count registers implicitly, rather than explicitly. In such instructions, the address-size prefix affects the size of such addressing and count registers, just as it does when such registers are explicitly referenced. Table 1-4 lists all such instructions and the registers referenced using the three possible address sizes.

Table 1-4. Pointer and Count Registers and the Address-Size Prefix

Instruction	Pointer or Count Register		
	16-Bit Address Size	32-Bit Address Size	64-Bit Address Size
CMPS, CMPSB, CMPSW, CMPSD, CMPSQ —Compare Strings	SI, DI, CX	ESI, EDI, ECX	RSI, RDI, RCX
INS, INSB, INSW, INSD —Input String	DI, CX	EDI, ECX	RDI, RCX
JCXZ, JECXZ, JRCXZ —Jump on CX/ECX/RCX Zero	CX	ECX	RCX
LODS, LODSB, LODSW, LODSD, LODSQ —Load String	SI, CX	ESI, ECX	RSI, RCX
LOOP, LOOPE, LOOPNZ, LOOPNE, LOOPZ —Loop	CX	ECX	RCX
MOVS, MOVSB, MOVSW, MOVSD, MOVSQ —Move String	SI, DI, CX	ESI, EDI, ECX	RSI, RDI, RCX
OUTS, OUTSB, OUTSW, OUTSD —Output String	SI, CX	ESI, ECX	RSI, RCX
REP, REPE, REPNE, REPNZ, REPZ —Repeat Prefixes	CX	ECX	RCX
SCAS, SCASB, SCASW, SCASD, SCASQ —Scan String	DI, CX	EDI, ECX	RDI, RCX
STOS, STOSB, STOSW, STOSD, STOSQ —Store String	DI, CX	EDI, ECX	RDI, RCX
XLAT, XLATB —Table Look-up Translation	BX	EBX	RBX

1.2.4 Segment-Override Prefixes

Segment overrides can be used only with instructions that reference non-stack memory. Most instructions that reference memory are encoded with a ModRM byte (page 20). The default segment for such memory-referencing instructions is implied by the base register indicated in its ModRM byte, as follows:

- *Instructions that Reference a Non-Stack Segment*—If an instruction encoding references any base register other than rBP or rSP, or if an instruction contains an immediate offset, the default segment is the data segment (DS). These instructions can use the segment-override prefix to select one of the non-default segments, as shown in Table 1-5.
- *String Instructions*—String instructions reference two memory operands. By default, they reference both the DS and ES segments (DS:rSI and ES:rDI). These instructions can override their DS-segment reference, as shown in Table 1-5, but they cannot override their ES-segment reference.
- *Instructions that Reference the Stack Segment*—If an instruction's encoding references the rBP or rSP base register, the default segment is the stack segment (SS). All instructions that reference the stack (push, pop, call, interrupt, return from interrupt) use SS by default. These instructions cannot use the segment-override prefix.

Table 1-5. Segment-Override Prefixes

Mnemonic	Prefix Byte (Hex)	Description
CS ¹	2E	Forces use of current CS segment for memory operands.
DS ¹	3E	Forces use of current DS segment for memory operands.
ES ¹	26	Forces use of current ES segment for memory operands.
FS	64	Forces use of current FS segment for memory operands.
GS	65	Forces use of current GS segment for memory operands.
SS ¹	36	Forces use of current SS segment for memory operands.
Note:		
1. In 64-bit mode, the CS, DS, ES, and SS segment overrides are ignored.		

Segment Overrides in 64-Bit Mode. In 64-bit mode, the CS, DS, ES, and SS segment-override prefixes have no effect. These four prefixes are not treated as segment-override prefixes for the purposes of multiple-prefix rules. Instead, they are treated as null prefixes.

The FS and GS segment-override prefixes are treated as true segment-override prefixes in 64-bit mode. Use of the FS or GS prefix causes their respective segment bases to be added to the effective address calculation. See “FS and GS Registers in 64-Bit Mode” in Volume 2 for details.

1.2.5 Lock Prefix

The LOCK prefix causes certain kinds of memory read-modify-write instructions to occur atomically. The mechanism for doing so is implementation-dependent (for example, the mechanism may involve bus signaling or packet messaging between the processor and a memory controller). The prefix is intended to give the processor exclusive use of shared memory in a multiprocessor system.

The LOCK prefix can only be used with forms of the following instructions that write a memory operand: ADC, ADD, AND, BTC, BTR, BTS, CMPXCHG, CMPXCHG8B, DEC, INC, NEG, NOT, OR, SBB, SUB, XADD, XCHG, and XOR. An invalid-opcode exception occurs if the LOCK prefix is used with any other instruction.

1.2.6 Repeat Prefixes

The repeat prefixes cause repetition of certain instructions that load, store, move, input, or output strings. The prefixes should only be used with such string instructions. Two pairs of repeat prefixes, REPE/REPZ and REPNE/REPZ, perform the same repeat functions for certain compare-string and scan-string instructions. The repeat function uses rCX as a count register. The size of rCX is based on address size, as shown in Table 1-4 on page 8.

REP. The REP prefix repeats its associated string instruction the number of times specified in the counter register (rCX). It terminates the repetition when the value in rCX reaches 0. The prefix can only be used with the INS, LODS, MOVS, OUTS, and STOS instructions. Table 1-6 shows the valid REP prefix opcodes.

Table 1-6. REP Prefix Opcodes

Mnemonic	Opcode
REP INS <i>reg/mem8, DX</i> REP INSB	F3 6C
REP INS <i>reg/mem16/32, DX</i> REP INSW REP INSD	F3 6D
REP LODS <i>mem8</i> REP LODSB	F3 AC
REP LODS <i>mem16/32/64</i> REP LODSW REP LODSD REP LODSQ	F3 AD
REP MOVS <i>mem8, mem8</i> REP MOVSB	F3 A4
REP MOVS <i>mem16/32/64, mem16/32/64</i> REP MOVSW REP MOVSD REP MOVSQ	F3 A5
REP OUTS <i>DX, reg/mem8</i> REP OUTSB	F3 6E
REP OUTS <i>DX, reg/mem16/32</i> REP OUTSW REP OUTSD	F3 6F
REP STOS <i>mem8</i> REP STOSB	F3 AA
REP STOS <i>mem16/32/64</i> REP STOSW REP STOSD REP STOSQ	F3 AB

REPE and REPZ. REPE and REPZ are synonyms and have identical opcodes. These prefixes repeat their associated string instruction the number of times specified in the counter

register (rCX). The repetition terminates when the value in rCX reaches 0 or when the zero flag (ZF) is cleared to 0. The REPE and REPZ prefixes can only be used with the CMPS, CMPSB, CMPSD, CMPSW, SCAS, SCASB, SCASD, and SCASW instructions. Table 1-7 shows the valid REPE and REPZ prefix opcodes.

Table 1-7. REPE and REPZ Prefix Opcodes

Mnemonic	Opcode
REPx CMPS <i>mem8, mem8</i> REPx CMPSB	F3 A6
REPx CMPS <i>mem16/32/64, mem16/32/64</i> REPx CMPSW REPx CMPSD REPx CMPSQ	F3 A7
REPx SCAS <i>mem8</i> REPx SCASB	F3 AE
REPx SCAS <i>mem16/32/64</i> REPx SCASW REPx SCASD REPx SCASQ	F3 AF

REPNE and REPNZ. REPNE and REPNZ are synonyms and have identical opcodes. These prefixes repeat their associated string instruction the number of times specified in the counter register (rCX). The repetition terminates when the value in rCX reaches 0 or when the zero flag (ZF) is set to 1. The REPNE and REPNZ prefixes can only be used with the CMPS, CMPSB, CMPSD, CMPSW, SCAS, SCASB, SCASD, and SCASW instructions. Table 1-8 on page 13 shows the valid REPNE and REPNZ prefix opcodes.

Table 1-8. REPNE and REPNZ Prefix Opcodes

Mnemonic	Opcode
REPNe CMPS <i>mem8, mem8</i> REPNe CMPSB	F2 A6
REPNe CMPS <i>mem16/32/64, mem16/32/64</i> REPNe CMPSW REPNe CMPSD REPNe CMPSQ	F2 A7
REPNe SCAS <i>mem8</i> REPNe SCASB	F2 AE
REPNe SCAS <i>mem16/32/64</i> REPNe SCASW REPNe SCASD REPNe SCASQ	F2 AF

Instructions that Cannot Use Repeat Prefixes. In general, the repeat prefixes should only be used in the string instructions listed in tables 1-6, 1-7, and 1-8, and in 128-bit or 64-bit media instructions. When used in media instructions, the F2h and F3h prefixes act in a special way to modify the opcode rather than cause a repeat operation. The result of using a 66h operand-size prefix along with an F2h or F3h prefix in 128-bit or 64-bit media instructions is unpredictable.

Optimization of Repeats. Depending on the hardware implementation, the repeat prefixes can have a setup overhead. If the repeated count is variable, the overhead can sometimes be avoided by substituting a simple loop to move or store the data. Repeated string instructions can be expanded into equivalent sequences of inline loads and stores or a sequence of stores can be used to emulate a REP STOS.

For repeated string moves, performance can be maximized by moving the largest possible operand size. For example, use REP MOVSD rather than REP MOVSW and REP MOVSW rather than REP MOVSB. Use REP STOSD rather than REP STOSW and REP STOSW rather than REP MOVSB.

Depending on the hardware implementation, string moves with the direction flag (DF) cleared to 0 (up) may be faster than string moves with DF set to 1 (down). DF = 1 is only needed for certain cases of overlapping REP MOVSB, such as when the source and the destination overlap.

1.2.7 REX Prefixes

REX prefixes are a group of instruction-prefix bytes that can be used only in 64-bit mode. They enable access to the AMD64 register extensions. Figure 1-1 on page 1 and Figure 1-2 on page 2 show how a REX prefix fits within the byte order of instructions. REX prefixes enable the following features in 64-bit mode:

- Use of the extended GPR (Figure 2-3 on page 31) or XMM registers (Figure 2-8 on page 36).
- Use of the 64-bit operand size when accessing GPRs.
- Use of the extended control and debug registers, as described in “64-Bit-Mode Extended Control Registers” in Volume 2 and “64-Bit-Mode Extended Debug Registers” in Volume 2.
- Use of the uniform byte registers (AL–R15).

Table 1-9 shows the REX prefixes. The value of a REX prefix is in the range 40h through 4Fh, depending on the particular combination of AMD64 register extensions desired.

Table 1-9. REX Instruction Prefixes

Prefix Type	Mnemonic	Prefix Code (Hex)	Description
Register Extensions	REX.W	40 ¹ through 4F ¹	Access an AMD64 register extension.
	REX.R		
	REX.X		
	REX.B		
Note:			
1. See Table 1-11 for encoding of REX prefixes.			

A REX prefix is normally required with an instruction that accesses a 64-bit GPR or one of the extended GPR or XMM registers. Only a few instructions have an operand size that defaults to (or is fixed at) 64 bits in 64-bit mode, and thus do not

need a REX prefix. These exceptions to the normal rule are listed in Table 1-10.

An instruction can have only one REX prefix, although the prefix can express several extension features. If a REX prefix is used, it must immediately precede the first opcode byte in the instruction format. Any other placement of a REX prefix, or any use of a REX prefix in an instruction that does not access an extended register, is ignored. The legacy instruction-size limit of 15 bytes still applies to instructions that contain a REX prefix.

Table 1-10. Instructions Not Requiring REX Size Prefix in 64-Bit Mode

CALL (Near)	POP reg/mem
ENTER	POP reg
Jcc	POP FS
JrCXZ	POP GS
JMP (Near)	POPFQ
LEAVE	PUSH imm8
LGDT	PUSH imm32
LIDT	PUSH reg/mem
LLDT	PUSH reg
LOOP	PUSH FS
LOOPcc	PUSH GS
LTR	PUSHFQ
MOV CR(<i>n</i>)	RET (Near)
MOV DR(<i>n</i>)	

REX prefixes are a set of sixteen values that span one row of the main opcode map and occupy entries 40h through 4Fh. Table 1-11 and Figure 1-3 on page 18 show the prefix fields and their uses.

Table 1-11. REX Prefix-Byte Fields

Mnemonic	Bit Position	Definition
–	7–4	0100
REX.W	3	0 = Default operand size 1 = 64-bit operand size
REX.R	2	1-bit (high) extension of the ModRM <i>reg</i> field ¹ , thus permitting access to 16 registers.
REX.X	1	1-bit (high) extension of the SIB <i>index</i> field ¹ , thus permitting access to 16 registers.
REX.B	0	1-bit (high) extension of the ModRM <i>r/m</i> field ¹ , SIB <i>base</i> field ¹ , or opcode <i>reg</i> field, thus permitting access to 16 registers.
Note:		
1. For a description of the ModRM and SIB bytes, see “ModRM and SIB Bytes” on page 20.		

REX.W: Operand Width. Setting the REX.W bit to 1 specifies a 64-bit operand size. Like the existing 66h operand-size prefix, the REX 64-bit operand-size override has no effect on byte operations. For non-byte operations, the REX operand-size override takes precedence over the 66h prefix. If a 66h prefix is used together with a REX prefix that has the REX.W bit set to 1, the 66h prefix is ignored. However, if a 66h prefix is used together with a REX prefix that has the REX.W bit cleared to 0, the 66h prefix is not ignored and the operand size becomes 16 bits.

REX.R: Register. The REX.R bit adds a 1-bit (high) extension to the ModRM *reg* field (page 20) when that field encodes a GPR, XMM, control, or debug register. REX.R does not modify ModRM *reg* when that field specifies other registers or opcodes. REX.R is ignored in such cases.

REX.X: Index. The REX.X bit adds a 1-bit (high) extension to the SIB *index* field (page 20).

REX.B: Base. The REX.B bit either adds a 1-bit (high) extension to the base in the ModRM *r/m* field or SIB *base* field, or it adds a 1-bit (high) extension to the opcode *reg* field used for accessing GPRs. (See Table 2-2 on page 47 for more about the REX.B bit.)

Encoding Examples. Figure 1-3 on page 18 shows four examples of how the R, X, and B bits of REX prefixes are concatenated with fields from the ModRM byte, SIB byte, and opcode to specify register and memory addressing. The R, X, and B bits are described in Table 1-11 on page 16.

Byte-Register Addressing. In the legacy architecture, the byte registers (AH, AL, BH, BL, CH, CL, DH, and DL, shown in Figure 2-2 on page 30) are encoded in the ModRM *reg* or *r/m* field or in the opcode *reg* field as registers 0 through 7. The REX prefix provides an additional byte-register addressing capability that makes the least-significant byte of any GPR available for byte operations (Figure 2-3 on page 31). This provides a uniform set of byte, word, doubleword, and quadword registers better suited for register allocation by compilers.

Special Encodings for Registers. Readers who need to know the details of instruction encodings should be aware that certain combinations of the ModRM and SIB fields have special meaning for register encodings. For some of these combinations, the instruction fields expanded by the REX prefix are not decoded (treated as don't cares), thereby creating aliases of these encodings in the extended registers. Table 1-12 on page 19 describes how each of these cases behaves.

Implications for INC and DEC Instructions. The REX prefix values are taken from the 16 single-byte INC and DEC instructions, one for each of the eight GPRs. Therefore, these single-byte opcodes for INC and DEC are not available in 64-bit mode, although they are available in legacy and compatibility modes. The functionality of these INC and DEC instructions is still available in 64-bit mode, however, using the ModRM forms of those instructions (opcodes FF /0 and FF /1).

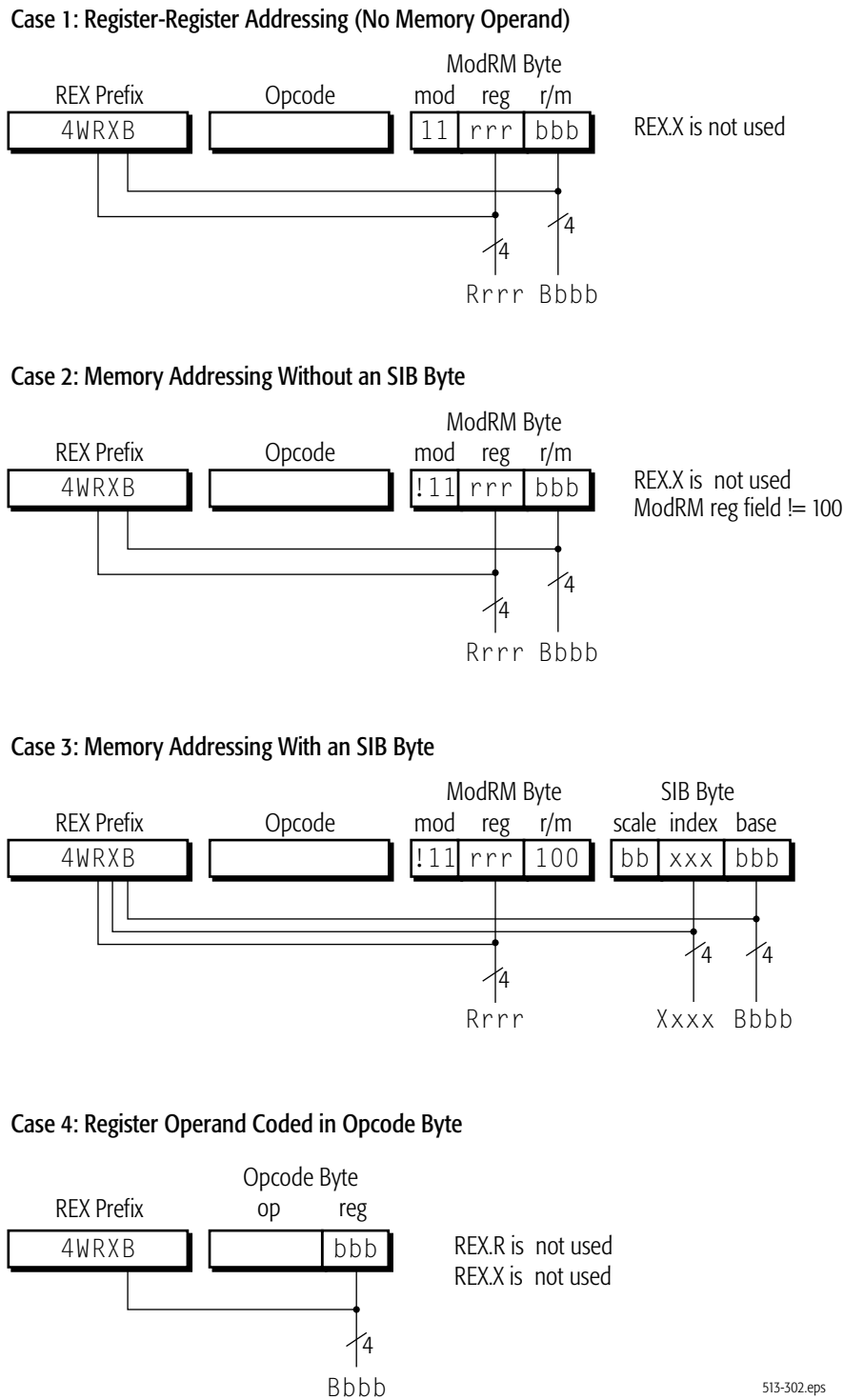

513-302.eps

Figure 1-3. Encoding Examples of REX-Prefix R, X, and B Bits

Table 1-12. Special REX Encodings for Registers

ModRM and SIB Encodings²	Meaning in Legacy and Compatibility Modes	Implications in Legacy and Compatibility Modes	Additional REX Implications
ModRM Byte: <ul style="list-style-type: none"> • mod \neq 11 • r/m¹ = 100 (ESP) 	SIB byte is present.	SIB byte is required for ESP-based addressing.	REX prefix adds a fourth bit (b), which is decoded and modifies the base register in the SIB byte. Therefore, the SIB byte is also required for R12-based addressing.
ModRM Byte: <ul style="list-style-type: none"> • mod = 00 • r/m¹ = x101 (EBP) 	Base register is not used.	Using EBP without a displacement must be done by setting mod = 01 with a displacement of 0 (with or without an index register).	REX prefix adds a fourth bit (x), which is not decoded (don't care). Therefore, using RBP or R13 without a displacement must be done via mod = 01 with a displacement of 0.
SIB Byte: <ul style="list-style-type: none"> • index¹ = x100 (ESP) 	Index register is not used.	ESP cannot be used as an index register.	REX prefix adds a fourth bit (x), which is decoded. Therefore, there are no additional implications. The expanded index field is used to distinguish RSP from R12, allowing R12 to be used as an index.
SIB Byte: <ul style="list-style-type: none"> • base = b101 (EBP) • ModRM.mod = 00 	Base register is not used if ModRM.mod = 00.	Base register depends on mod encoding. Using EBP with a scaled index and without a displacement must be done by setting mod = 01 with a displacement of 0.	REX prefix adds a fourth bit (b), which is not decoded (don't care). Therefore, using RBP or R13 without a displacement must be done via mod = 01 with a displacement of 0 (with or without an index register).
Notes: <ol style="list-style-type: none"> 1. The REX-prefix bit is shown in the fourth (most-significant) bit position of the encodings for the ModRM r/m, SIB index, and SIB base fields. The lower-case "x" for ModRM r/m (rather than the upper-case "B" shown in Figure 1-3 on page 18) indicates that the REX-prefix bit is not decoded (don't care). 2. For a description of the ModRM and SIB bytes, see "ModRM and SIB Bytes" on page 20. 			

1.3 Opcode

Each instruction has a unique opcode, although assemblers can support multiple mnemonics for a single instruction opcode. The opcode specifies the operation that the instruction performs and, in certain cases, the kinds of operands it uses. An opcode consists of one or two bytes, but certain 128-bit media instructions also use a prefix byte in a special way to modify the opcode. The 3-bit *reg* field of the ModRM byte (“ModRM and SIB Bytes” on page 20) is also used in certain instructions either for three additional opcode bits or for a register specification.

128-Bit and 64-Bit Media Instruction Opcodes. Many 128-bit and 64-bit media instructions include a 66h, F2h, or F3h prefix byte in a special way to modify the opcode. These same byte values can be used in certain general-purpose and x87 instructions to modify operand size (66h) or repeat the operation (F2h, F3h). In 128-bit and 64-bit media instructions, however, such prefix bytes modify the opcode. If a 128-bit or 64-bit media instruction uses one of these three prefixes, and also includes any other prefix in the 66h, F2h, and F3h group, the result is unpredictable.

All opcodes for 64-bit media instructions begin with a 0Fh byte. In the case of 64-bit floating-point (3DNow!) instructions, the 0Fh byte is followed by a second 0Fh opcode byte. A third opcode byte occupies the same position at the end of a 3DNow! instruction as would an immediate byte. The value of the immediate byte is shown as the third opcode byte-value in the syntax for each instruction in “64-Bit Media Instruction Reference” in Volume 5. The format is:

0Fh 0Fh ModRM [SIB] [displacement] 3DNow!_third_opcode_byte

For details on opcode encoding, see Appendix A, “Opcode and Operand Encodings.”

1.4 ModRM and SIB Bytes

The ModRM byte is used in certain instruction encodings to:

- Define a register reference.
- Define a memory reference.

- Provide additional opcode bits with which to define the instruction's function.

ModRM bytes have three fields—*mod*, *reg*, and *r/m*. The *reg* field provides additional opcode bits with which to define the function of the instruction or one of its operands. The *mod* and *r/m* fields are used together with each other and, in 64-bit mode, with the REX.R and REX.B bits of the REX prefix (page 14), to specify the location of an instruction's operands and certain of the possible addressing modes (specifically, the non-complex modes).

Figure 1-4 shows the format of a ModRM byte.

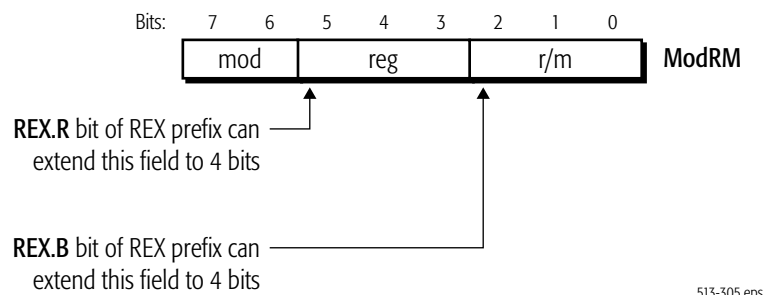

513-305.eps

Figure 1-4. ModRM-Byte Format

In some instructions, the ModRM byte is followed by an SIB byte, which defines memory addressing for the complex-addressing modes described in “Effective Addresses” in Volume 1. The SIB byte has three fields—*scale*, *index*, and *base*—that define the scale factor, index-register number, and base-register number for 32-bit and 64-bit complex addressing modes. In 64-bit mode, the REX.B and REX.X bits extend the encoding of the SIB byte's *base* and *index* fields.

Figure 1-5 shows the format of an SIB byte.

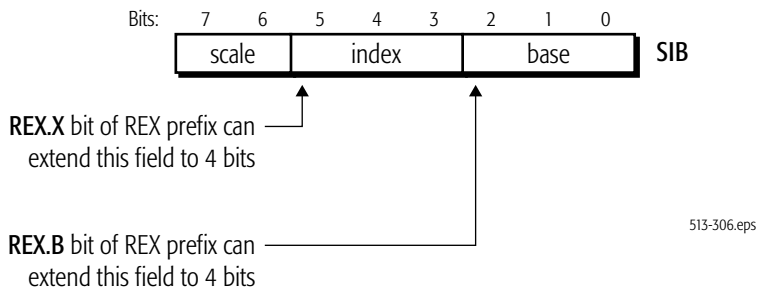

Figure 1-5. SIB-Byte Format

The encodings of ModRM and SIB bytes not only define memory-addressing modes, but they also specify operand registers. The encodings do this by using 3-bit fields in the ModRM and SIB bytes, depending on the format:

- *ModRM*: the *reg* and *r/m* fields of the ModRM byte. (Case 1 in Figure 1-3 on page 18 shows an example of this).
- *ModRM with SIB*: the *reg* field of the ModRM byte and the *base* and *index* fields of the SIB byte. (Case 3 in Figure 1-3 on page 18 shows an example of this).
- *Instructions without ModRM*: the *reg* field of the opcode. (Case 4 in Figure 1-3 on page 18 shows an example of this).

In 64-bit mode, the bits needed to extend each field for accessing the additional registers are provided by the REX prefixes, as shown in Figure 1-4 and Figure 1-5.

For details on opcode encoding, see Appendix A, “Opcode and Operand Encodings.”

1.5 Displacement Bytes

A *displacement* (also called an *offset*) is a signed value that is added to the base of a code segment (absolute addressing) or to an instruction pointer (relative addressing), depending on the addressing mode. The size of a displacement is 1, 2, or 4 bytes. If an addressing mode requires a displacement, the bytes (1, 2, or 4) for the displacement follow the opcode, ModRM, or SIB byte (whichever comes last) in the instruction encoding.

In 64-bit mode, the same ModRM and SIB encodings are used to specify displacement sizes as those used in legacy and compatibility modes. However, the displacement is sign-extended to 64 bits during effective-address calculations. Also, in 64-bit mode, support is provided for some 64-bit displacement and immediate forms of the MOV instruction. See “Immediate Operand Size” in Volume 1 for more information on this.

1.6 Immediate Bytes

An *immediate* is a value—typically an operand value—encoded directly into the instruction. Depending on the opcode and the operating mode, the size of an immediate operand can be 1, 2, or 4 bytes. Immediate operands in 64-bit mode are limited to these same sizes. In 64-bit mode, support is provided for some 64-bit displacement and immediate forms of the MOV instruction. See “Immediate Operand Size” in Volume 1 for more information on this.

If an instruction takes an immediate operand, the bytes (1, 2, or 4) for the immediate follow the opcode, ModRM, SIB, or displacement bytes (whichever come last) in the instruction encoding. Some 128-bit media instructions use the immediate byte as a condition code.

1.7 RIP-Relative Addressing

In 64-bit mode, addressing relative to the contents of the 64-bit instruction pointer (program counter)—called RIP-relative addressing or PC-relative addressing—is implemented for certain instructions. In such cases, the effective address is formed by adding the displacement to the 64-bit RIP of the next instruction.

In the legacy x86 architecture, addressing relative to the instruction pointer is available only in control-transfer instructions. In the 64-bit mode, any instruction that uses ModRM addressing can use RIP-relative addressing. This feature is particularly useful for addressing data in position-independent code and for code that addresses global data.

Without RIP-relative addressing, ModRM instructions address memory relative to zero. With RIP-relative addressing, ModRM

instructions can address memory relative to the 64-bit RIP using a signed 32-bit displacement. This provides an offset range of ± 2 Gbytes from the RIP.

Programs usually have many references to data, especially global data, that are not register-based. To load such a program, the loader typically selects a location for the program in memory and then adjusts program references to global data based on the load location. RIP-relative addressing of data makes this adjustment unnecessary.

1.7.1 Encoding

Table 1-13 shows the ModRM and SIB encodings for RIP-relative addressing. Redundant forms of 32-bit displacement-only addressing exist in the current ModRM and SIB encodings. There is one ModRM encoding with several SIB encodings. RIP-relative addressing is encoded using one of the redundant forms. In 64-bit mode, the ModRM *Disp32* (32-bit displacement) encoding is redefined to be $RIP + Disp32$ rather than displacement-only.

Table 1-13. Encoding for RIP-Relative Addressing

ModRM and SIB Encodings	Meaning in Legacy and Compatibility Modes	Meaning in 64-bit Mode	Additional 64-bit Implications
ModRM Byte: <ul style="list-style-type: none"> • mod = 00 • r/m = 101 (none) 	Disp32	$RIP + Disp32$	Zero-based (normal) displacement addressing must use SIB form (see next row).
SIB Byte: <ul style="list-style-type: none"> • base = 101 (none) • index = 100 (none) • scale = 1, 2, 4, 8 	If mod = 00, Disp32	Same as Legacy	None

1.7.2 REX Prefix and RIP-Relative Addressing

ModRM encoding for RIP-relative addressing does not depend on a REX prefix. In particular, the *r/m* encoding of 101, used to select RIP-relative addressing, is not affected by the REX prefix. For example, selecting R13 (REX.B = 1, *r/m* = 101) with mod = 00 still results in RIP-relative addressing.

The four-bit *r/m* field of ModRM is not fully decoded. Therefore, in order to address R13 with no displacement, software must encode it as $R13 + 0$ using a one-byte displacement of zero.

1.7.3 **Address-Size Prefix and RIP-Relative Addressing**

RIP-relative addressing is enabled by 64-bit mode, not by a 64-bit address-size. Conversely, use of the address-size prefix (“Address-Size Override Prefix” on page 6) does not disable RIP-relative addressing. The effect of the address-size prefix is to truncate and zero-extend the computed effective address to 32 bits, like any other addressing mode.

2 Instruction Overview

2.1 Instruction Subsets

For easier reference, the instruction descriptions are divided into five instruction subsets. The following sections describe the function, mnemonic syntax, opcodes, affected flags, and possible exceptions generated by all instructions in the AMD64 architecture:

- *Chapter 3, “General-Purpose Instruction Reference”*—The general-purpose instructions are used in basic software execution. Most of these load, store, or operate on data in the general-purpose registers (GPRs), in memory, or in both. Other instructions are used to alter sequential program flow by branching to other locations within the program or to entirely different programs.
- *Chapter 4, “System Instruction Reference”*—The system instructions establish the processor operating mode, access processor resources, handle program and system errors, and manage memory.
- *“128-Bit Media Instruction Reference” in Volume 4*—The 128-bit media instructions load, store, or operate on data located in the 128-bit XMM registers. These instructions define both vector and scalar operations on floating-point and integer data types. They include the SSE and SSE2 instructions that operate on the XMM registers. Some of these instructions convert source operands in XMM registers to destination operands in GPR, MMX, or x87 registers or otherwise affect XMM state.
- *“64-Bit Media Instruction Reference” in Volume 5*—The 64-bit media instructions load, store, or operate on data located in the 64-bit MMX registers. These instructions define both vector and scalar operations on integer and floating-point data types. They include the legacy MMX™ instructions, the 3DNow!™ instructions, and the AMD extensions to the MMX and 3DNow! instruction sets. Some of these instructions convert source operands in MMX registers to destination operands in GPR, XMM, or x87 registers or otherwise affect MMX state.

- “x87 Floating-Point Instruction Reference” in Volume 5—The x87 instructions are used in legacy floating-point applications. Most of these instructions load, store, or operate on data located in the x87 ST(0)–ST(7) stack registers (the FPR0–FPR7 physical registers). The remaining instructions within this category are used to manage the x87 floating-point environment.

The description of each instruction covers its behavior in all operating modes, including legacy mode (real, virtual-8086, and protected modes) and long mode (compatibility and 64-bit modes). Details of certain kinds of complex behavior—such as control-flow changes in CALL, INT, or FXSAVE instructions—have cross-references in the instruction-detail pages to detailed descriptions in volumes 1 and 2.

Two instructions—CMPSD and MOVSD—use the same mnemonic for different instructions. Assemblers can distinguish them on the basis of the number and type of operands with which they are used.

2.2 Reference-Page Format

Figure 2-1 on page 29 shows the format of an instruction-detail page. The instruction mnemonic is shown in bold at the top-left, along with its name. In this example, **POPF** is the mnemonic and *POP to EFLAGS Doubleword* is the name. Next, there is a general description of the instruction’s operation. Many descriptions have cross-references to more detail in other parts of the manual.

Beneath the general description, the mnemonic is shown again, together with the related opcode(s) and a description summary. Related instructions are listed below this, followed by a table showing the flags that the instruction can affect. Finally, each instruction has a summary of the possible exceptions that can occur when executing the instruction. The columns labeled “Real” and “Virtual-8086” apply only to execution in legacy mode. The column labeled “Protected” applies both to legacy mode and long mode, because long mode is a superset of legacy protected mode.

The 128-bit and 64-bit media instructions also have diagrams illustrating the operation. A few instructions have examples or pseudocode describing the action.

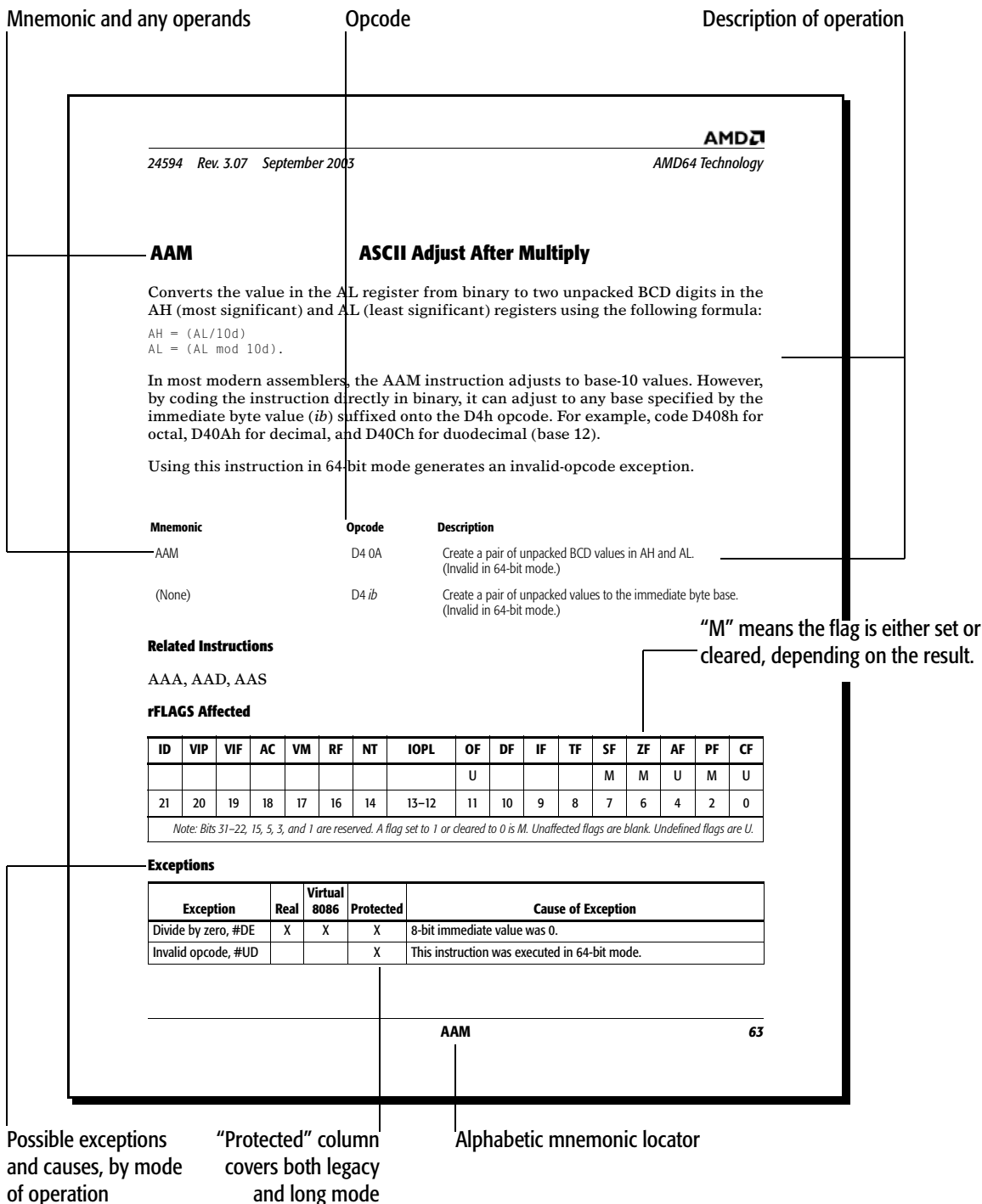

Figure 2-1. Format of Instruction-Detail Pages

2.3 Summary of Registers and Data Types

This section summarizes the registers available to software using the five instruction subsets described in “Instruction Subsets” on page 27. For details on the organization and use of these registers, see their respective chapters in volumes 1 and 2.

2.3.1 General-Purpose Instructions

Registers. The size and number of general-purpose registers (GPRs) depends on the operating mode, as do the size of the flags and instruction-pointer registers. Figure 2-2 shows the registers available in legacy and compatibility modes.

register encoding	high 8-bit	low 8-bit	16-bit	32-bit
0	AH (4)	AL	AX	EAX
3	BH (7)	BL	BX	EBX
1	CH (5)	CL	CX	ECX
2	DH (6)	DL	DX	EDX
6	SI		SI	ESI
7	DI		DI	EDI
5	BP		BP	EBP
4	SP		SP	ESP
	31	16 15		
	31		FLAGS	FLAGS EFLAGS
	31		IP	IP EIP
		0		

513-311.eps

Figure 2-2. General Registers in Legacy and Compatibility Modes

Figure 2-3 on page 31 shows the registers accessible in 64-bit mode. Compared with legacy mode, registers become 64 bits wide, eight new data registers (R8–R15) are added and the low byte of all 16 GPRs is available for byte operations, and the four high-byte registers of legacy mode (AH, BH, CH, and DH) are not available if the REX prefix is used. The high 32 bits of

doubleword operands are zero-extended to 64 bits, but the high bits of word and byte operands are not modified by operations in 64-bit mode. The RFLAGS register is 64 bits wide, but the high 32 bits are reserved. They can be written with anything but they read as zeros (RAZ).

register encoding	zero-extended for 32-bit operands	not modified for 16-bit operands	not modified for 8-bit operands	low 8-bit	16-bit	32-bit	64-bit
0			AH*	AL	AX	EAX	RAX
3			BH*	BL	BX	EBX	RBX
1			CH*	CL	CX	ECX	RCX
2			DH*	DL	DX	EDX	RDX
6				SIL**	SI	ESI	RSI
7				DIL**	DI	EDI	RDI
5				BPL**	BP	EBP	RBP
4				SPL**	SP	ESP	RSP
8				R8B	R8W	R8D	R8
9				R9B	R9W	R9D	R9
10				R10B	R10W	R10D	R10
11				R11B	R11W	R11D	R11
12				R12B	R12W	R12D	R12
13				R13B	R13W	R13D	R13
14				R14B	R14W	R14D	R14
15				R15B	R15W	R15D	R15

0		
---	--	--

0		
---	--	--

RFLAGS 513-309.eps

RIP

* Not addressable when a REX prefix is used.

** Only addressable when a REX prefix is used.

Figure 2-3. General Registers in 64-Bit Mode

For most instructions running in 64-bit mode, access to the extended GPRs requires a REX instruction prefix (page 14).

Figure 2-4 shows the segment registers which, like the instruction pointer, are used by all instructions. In legacy and compatibility modes, all segments are accessible. In 64-bit mode, which uses the flat (non-segmented) memory model, only the CS, FS, and GS segments are recognized, whereas the contents of the DS, ES, and SS segment registers are ignored (the base for each of these segments is assumed to be zero, and neither their segment limit nor attributes are checked). For details, see “Segmented Virtual Memory” in Volume 2.

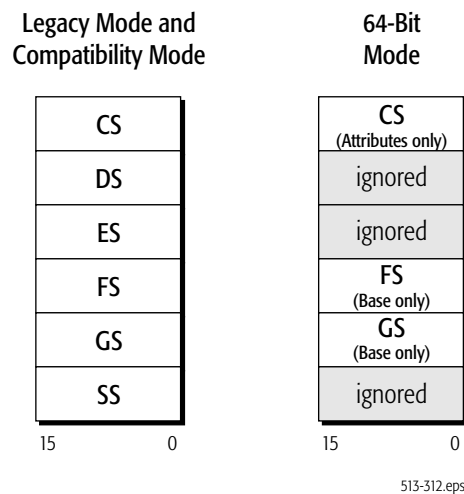

Figure 2-4. Segment Registers

Data Types. Figure 2-5 on page 33 shows the general-purpose data types. They are all scalar, integer data types. The 64-bit (quadword) data types are only available in 64-bit mode, and for most instructions they require a REX instruction prefix.

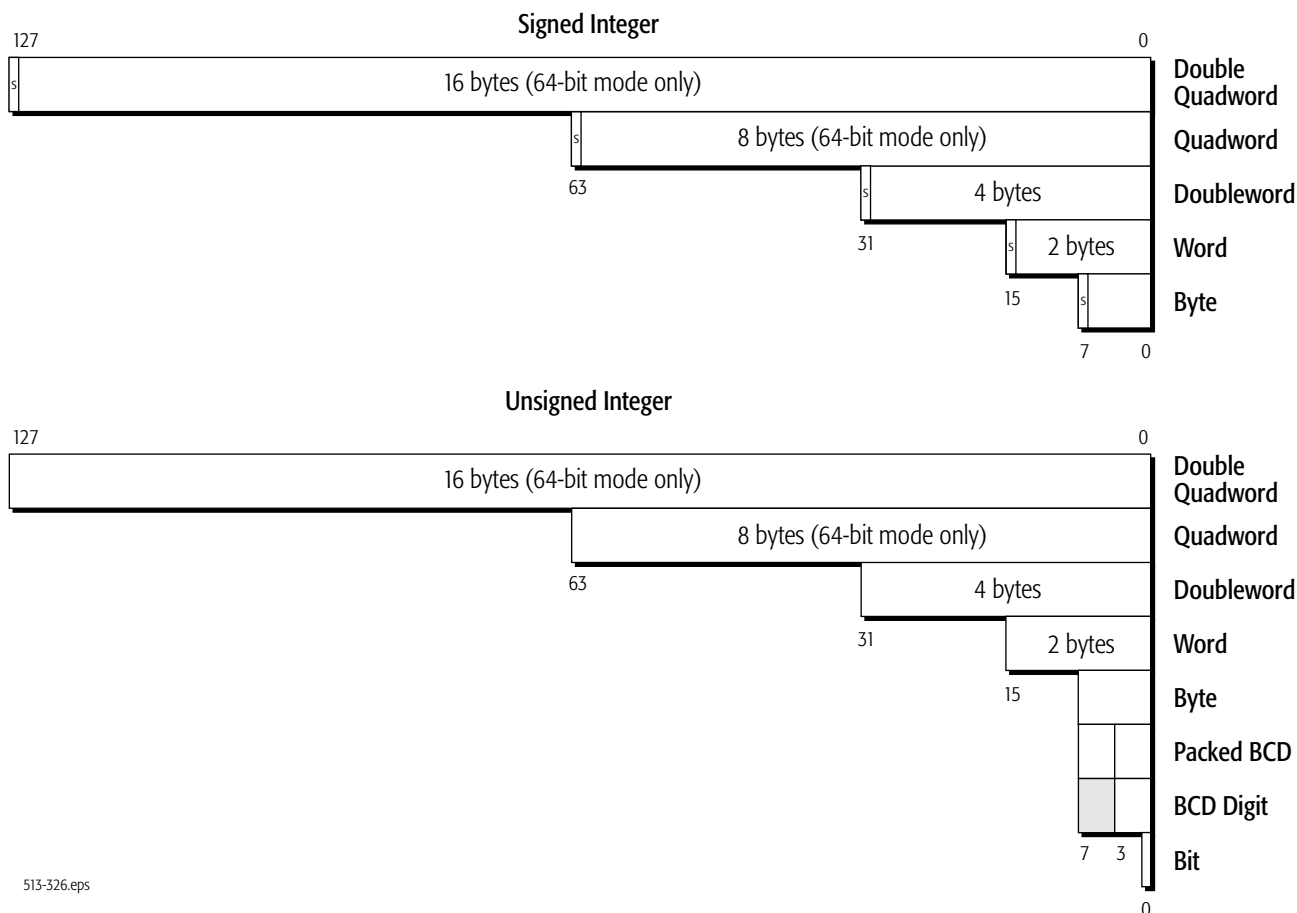
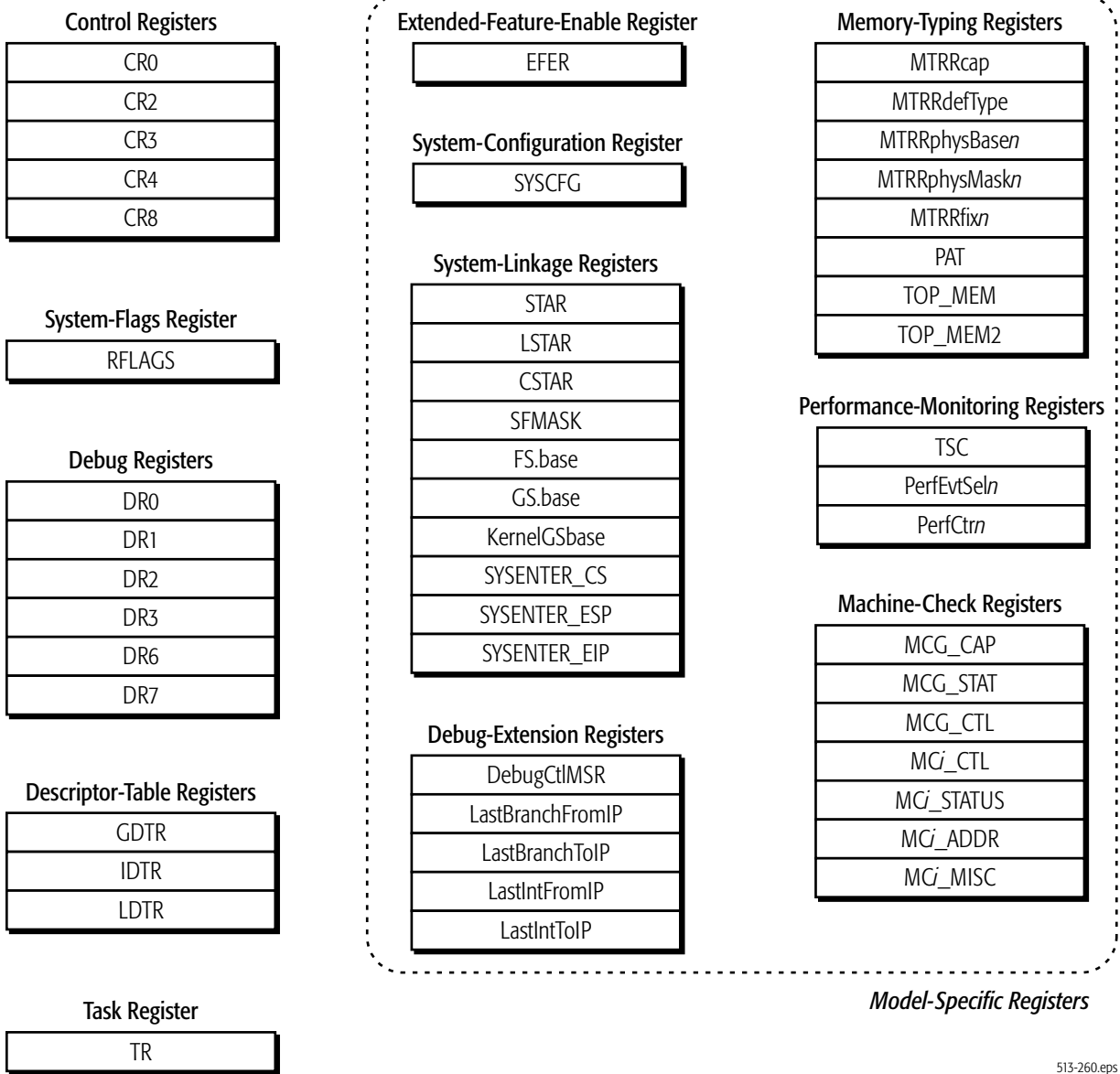

Figure 2-5. General-Purpose Data Types

2.3.2 System Instructions

Registers. The system instructions use several specialized registers shown in Figure 2-6 on page 34. System software uses these registers to, among other things, manage the processor's operating environment, define system resource characteristics, and monitor software execution. With the exception of the RFLAGS register, system registers can be read and written only from privileged software.

All system registers are 64 bits wide, except for the descriptor-table registers and the task register, which include 64-bit base-address fields and other fields.



513-260.eps

Figure 2-6. System Registers

Data Structures. Figure 2-7 on page 35 shows the system data structures. These are created and maintained by system software for use in protected mode. A processor running in protected mode uses these data structures to manage memory and protection, and to store program-state information when an interrupt or task switch occurs.

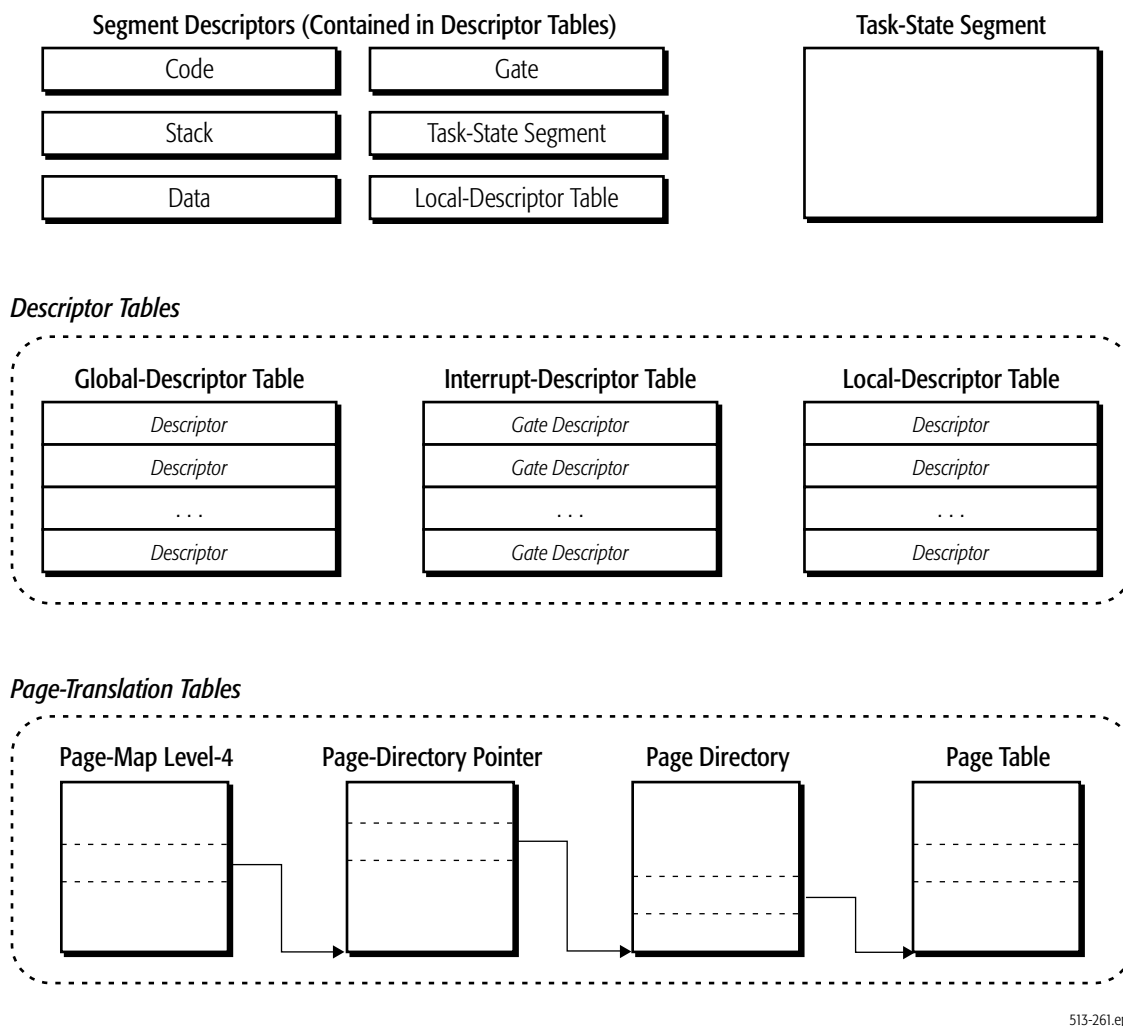

Figure 2-7. System Data Structures

2.3.3 128-Bit Media Instructions

Registers. The 128-bit media instructions use the 128-bit XMM registers. The number of available XMM data registers depends on the operating mode, as shown in Figure 2-8 on page 36. In legacy and compatibility modes, the eight legacy XMM data registers (XMM0–XMM7) are available. In 64-bit mode, eight additional XMM data registers (XMM8–XMM15) are available when a REX instruction prefix is used.

The MXCSR register contains floating-point and other control and status flags used by the 128-bit media instructions. Some 128-bit media instructions also use the GPR (Figure 2-2 and

Figure 2-3) and the MMX registers (Figure 2-10 on page 38) or set or clear flags in the rFLAGS register (see Figure 2-2 and Figure 2-3).

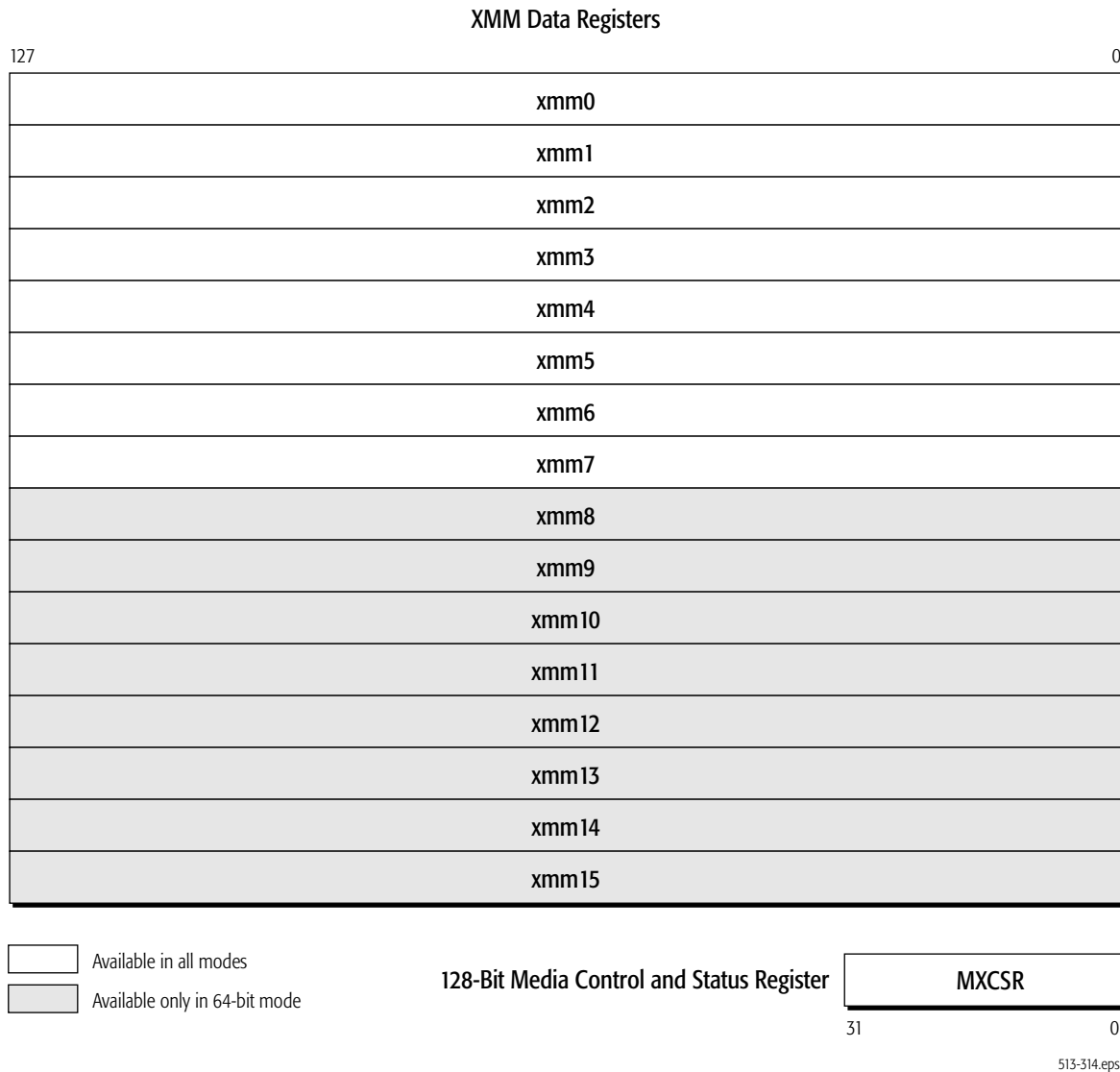

Figure 2-8. 128-Bit Media Registers

Data Types. Figure 2-9 on page 37 shows the 128-bit media data types. They include floating-point and integer vectors and floating-point scalars. The floating-point data types include IEEE-754 single precision and double precision types.

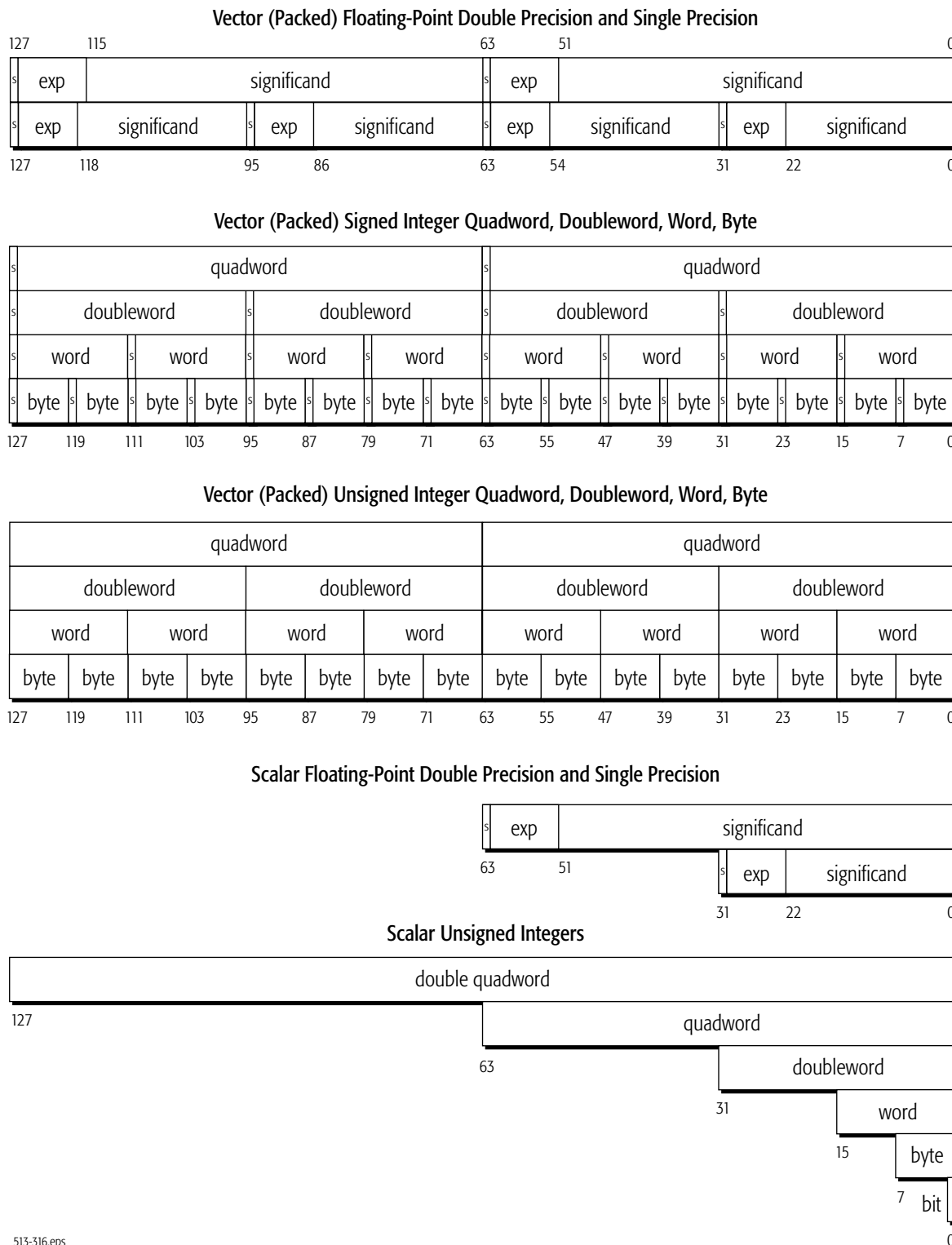
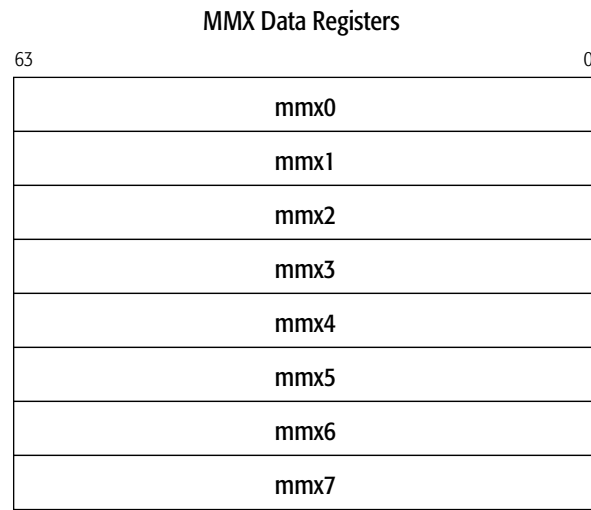

Figure 2-9. 128-Bit Media Data Types

2.3.4 64-Bit Media Instructions

Registers. The 64-bit media instructions use the eight 64-bit MMX registers, as shown in Figure 2-10. These registers are mapped onto the x87 floating-point registers, and 64-bit media instructions write the x87 tag word in a way that prevents an x87 instruction from using MMX data.

Some 64-bit media instructions also use the GPR (Figure 2-2 and Figure 2-3) and the XMM registers (Figure 2-8).



513-327.eps

Figure 2-10. 64-Bit Media Registers

Data Types. Figure 2-11 on page 39 shows the 64-bit media data types. They include floating-point and integer vectors and integer scalars. The floating-point data type, used by 3DNow! instructions, consists of a packed vector or two IEEE-754 32-bit single-precision data types. Unlike other kinds of floating-point instructions, however, the 3DNow!™ instructions do not generate floating-point exceptions. For this reason, there is no register for reporting or controlling the status of exceptions in the 64-bit-media instruction subset.

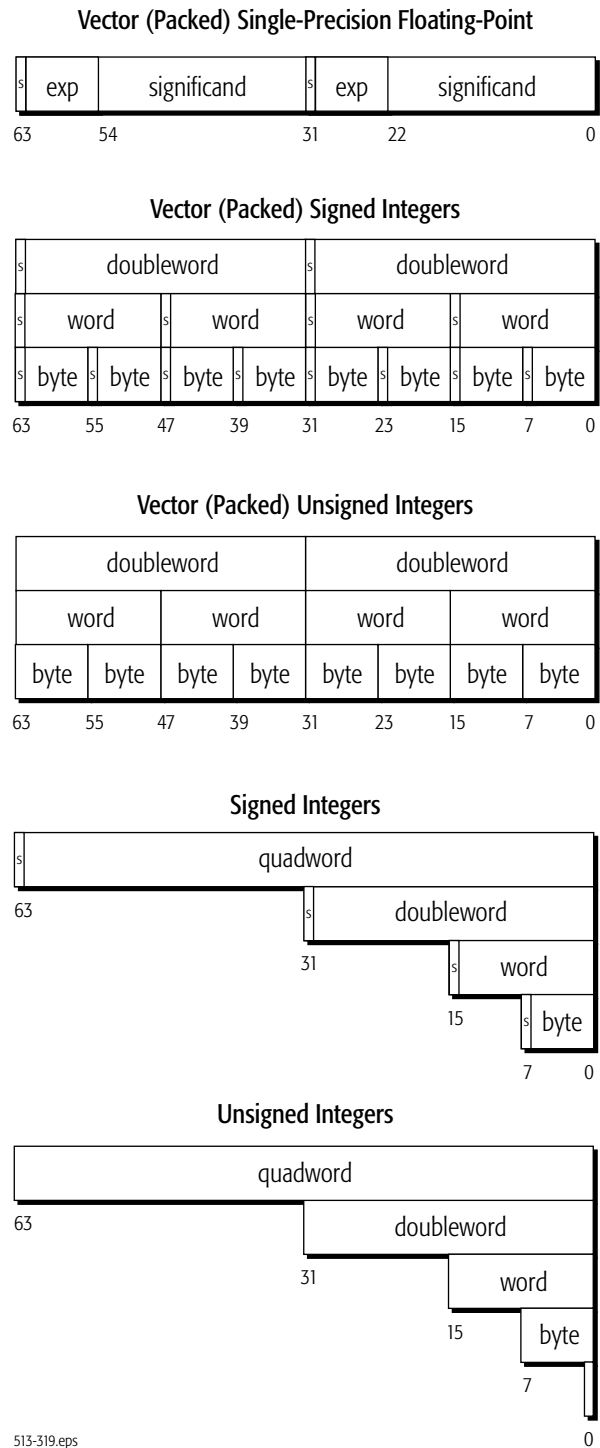
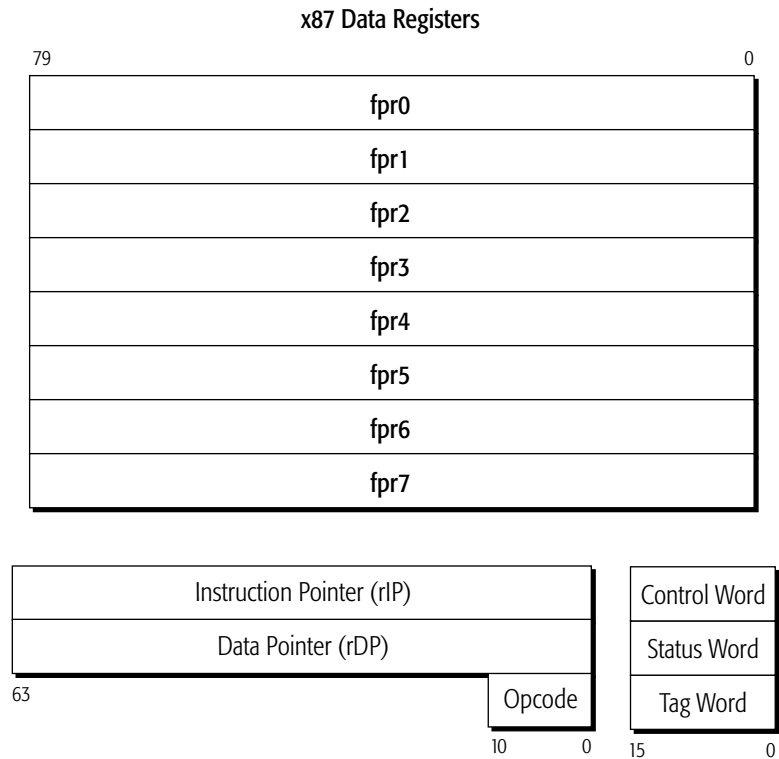

Figure 2-11. 64-Bit Media Data Types

2.3.5 x87 Floating-Point Instructions

Registers. The x87 floating-point instructions use the x87 registers shown in Figure 2-12. There are eight 80-bit data registers, three 16-bit registers that hold the x87 control word, status word, and tag word, and three registers (last instruction pointer, last opcode, last data pointer) that hold information about the last x87 operation.

The physical data registers are named FPR0–FPR7, although x87 software references these registers as a stack of registers, named ST(0)–ST(7). The x87 instructions store operands only in their own 80-bit floating-point registers or in memory. They do not access the GPR or XMM registers.



513-321.eps

Figure 2-12. x87 Registers

Data Types. Figure 2-13 on page 41 shows all x87 data types. They include three floating-point formats (80-bit double-extended precision, 64-bit double precision, and 32-bit single precision), three signed-integer formats (quadword, doubleword, and

word), and an 80-bit packed binary-coded decimal (BCD) format.

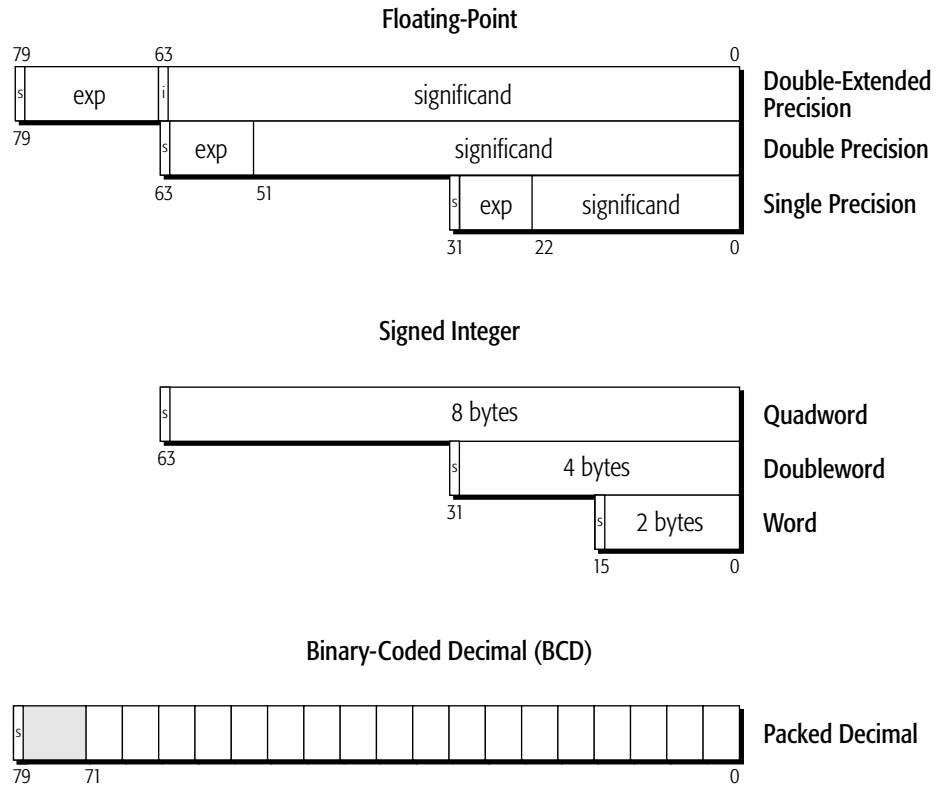

513-317.eps

Figure 2-13. x87 Data Types

2.4 Summary of Exceptions

Table 2-1 on page 42 lists all possible exceptions. The table shows the interrupt-vector numbers, names, mnemonics, source, and possible causes. Exceptions that apply to specific instructions are documented with each instruction in the instruction-detail pages that follow.

Table 2-1. Interrupt-Vector Source and Cause

Vector	Interrupt (Exception)	Mnemonic	Source	Cause
0	Divide-By-Zero-Error	#DE	Software	DIV, IDIV, AAM instructions
1	Debug	#DB	Internal	Instruction accesses and data accesses
2	Non-Maskable-Interrupt	#NMI	External	External NMI signal
3	Breakpoint	#BP	Software	INT3 instruction
4	Overflow	#OF	Software	INTO instruction
5	Bound-Range	#BR	Software	BOUND instruction
6	Invalid-Opcode	#UD	Internal	Invalid instructions
7	Device-Not-Available	#NM	Internal	x87 instructions
8	Double-Fault	#DF	Internal	Interrupt during an interrupt
9	Coprocessor-Segment-Overrun	–	External	Unsupported (reserved)
10	Invalid-TSS	#TS	Internal	Task-state segment access and task switch
11	Segment-Not-Present	#NP	Internal	Segment access through a descriptor
12	Stack	#SS	Internal	SS register loads and stack references
13	General-Protection	#GP	Internal	Memory accesses and protection checks
14	Page-Fault	#PF	Internal	Memory accesses when paging enabled
15	Reserved	–		
16	Floating-Point Exception-Pending	#MF	Software	x87 floating-point and 64-bit media floating-point instructions
17	Alignment-Check	#AC	Internal	Memory accesses
18	Machine-Check	#MC	Internal External	Model specific
19	SIMD Floating-Point	#XF	Internal	128-bit media floating-point instructions
20–31	Reserved (Internal and External)	–		
0–255	External Interrupts (Maskable)	#INTR	External	External interrupt signal
0–255	Software Interrupts	–	Software	INT n instruction

2.5 Notation

2.5.1 Mnemonic Syntax

Each instruction has a syntax that includes the mnemonic and any operands that the instruction can take. Figure 2-14 shows an example of a syntax in which the instruction takes two operands. In most instructions that take two operands, the first (left-most) operand is both a source operand (the first source operand) and the destination operand. The second (right-most) operand serves only as a source, not a destination.

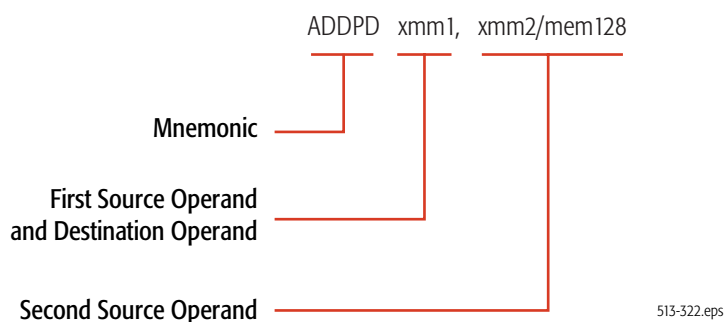

Figure 2-14. Syntax for Typical Two-Operand Instruction

The following notation is used to denote the size and type of source and destination operands:

- *cReg*—Control register.
- *dReg*—Debug register.
- *imm8*—Byte (8-bit) immediate.
- *imm16*—Word (16-bit) immediate.
- *imm16/32*—Word (16-bit) or doubleword (32-bit) immediate.
- *imm32*—Doubleword (32-bit) immediate.
- *imm32/64*—Doubleword (32-bit) or quadword (64-bit) immediate.
- *imm64*—Quadword (64-bit) immediate.
- *mem*—An operand of unspecified size in memory.
- *mem8*—Byte (8-bit) operand in memory.
- *mem16*—Word (16-bit) operand in memory.
- *mem16/32*—Word (16-bit) or doubleword (32-bit) operand in memory.
- *mem32*—Doubleword (32-bit) operand in memory.

- *mem32/48*—Doubleword (32-bit) or 48-bit operand in memory.
- *mem48*—48-bit operand in memory.
- *mem64*—Quadword (64-bit) operand in memory.
- *mem128*—Double quadword (128-bit) operand in memory.
- *mem16:16*—Two sequential word (16-bit) operands in memory.
- *mem16:32*—A doubleword (32-bit) operand followed by a word (16-bit) operand in memory.
- *mem32real*—Single-precision (32-bit) floating-point operand in memory.
- *mem32int*—Doubleword (32-bit) integer operand in memory.
- *mem64real*—Double-precision (64-bit) floating-point operand in memory.
- *mem64int*—Quadword (64-bit) integer operand in memory.
- *mem80real*—Double-extended-precision (80-bit) floating-point operand in memory.
- *mem80dec*—80-bit packed BCD operand in memory, containing 18 4-bit BCD digits.
- *mem2env*—16-bit x87 control word or x87 status word.
- *mem14/28env*—14-byte or 28-byte x87 environment. The x87 environment consists of the x87 control word, x87 status word, x87 tag word, last non-control instruction pointer, last data pointer, and opcode of the last non-control instruction completed.
- *mem94/108env*—94-byte or 108-byte x87 environment and register stack.
- *mem512env*—512-byte environment for 128-bit media, 64-bit media, and x87 instructions.
- *mmx*—Quadword (64-bit) operand in an MMX register.
- *mmx1*—Quadword (64-bit) operand in an MMX register, specified as the left-most (first) operand in the instruction syntax.
- *mmx2*—Quadword (64-bit) operand in an MMX register, specified as the right-most (second) operand in the instruction syntax.
- *mmx/mem32*—Doubleword (32-bit) operand in an MMX register or memory.

- *mmx/mem64*—Quadword (64-bit) operand in an MMX register or memory.
- *mmx1/mem64*—Quadword (64-bit) operand in an MMX register or memory, specified as the left-most (first) operand in the instruction syntax.
- *mmx2/mem64*—Quadword (64-bit) operand in an MMX register or memory, specified as the right-most (second) operand in the instruction syntax.
- *moffset*—Direct memory offset that specifies an operand in memory.
- *moffset8*—Direct memory offset that specifies a byte (8-bit) operand in memory.
- *moffset16*—Direct memory offset that specifies a word (16-bit) operand in memory.
- *moffset32*—Direct memory offset that specifies a doubleword (32-bit) operand in memory.
- *moffset64*—Direct memory offset that specifies a quadword (64-bit) operand in memory.
- *pntr16:16*—Far pointer with 16-bit selector and 16-bit offset.
- *pntr16:32*—Far pointer with 16-bit selector and 32-bit offset.
- *reg*—Operand of unspecified size in a GPR register.
- *reg8*—Byte (8-bit) operand in a GPR register.
- *reg16*—Word (16-bit) operand in a GPR register.
- *reg16/32*—Word (16-bit) or doubleword (32-bit) operand in a GPR register.
- *reg32*—Doubleword (32-bit) operand in a GPR register.
- *reg64*—Quadword (64-bit) operand in a GPR register.
- *reg/mem8*—Byte (8-bit) operand in a GPR register or memory.
- *reg/mem16*—Word (16-bit) operand in a GPR register or memory.
- *reg/mem32*—Doubleword (32-bit) operand in a GPR register or memory.
- *reg/mem64*—Quadword (64-bit) operand in a GPR register or memory.
- *rel8off*—Signed 8-bit offset relative to the instruction pointer.

- *rel16off*—Signed 16-bit offset relative to the instruction pointer.
- *rel32off*—Signed 32-bit offset relative to the instruction pointer.
- *segReg* or *sReg*—Word (16-bit) operand in a segment register.
- *ST(0)*—x87 stack register 0.
- *ST(i)*—x87 stack register *i*, where *i* is between 0 and 7.
- *xmm*—Double quadword (128-bit) operand in an XMM register.
- *xmm1*—Double quadword (128-bit) operand in an XMM register, specified as the left-most (first) operand in the instruction syntax.
- *xmm2*—Double quadword (128-bit) operand in an XMM register, specified as the right-most (second) operand in the instruction syntax.
- *xmm/mem64*—Quadword (64-bit) operand in a 128-bit XMM register or memory.
- *xmm/mem128*—Double quadword (128-bit) operand in an XMM register or memory.
- *xmm1/mem128*—Double quadword (128-bit) operand in an XMM register or memory, specified as the left-most (first) operand in the instruction syntax.
- *xmm2/mem128*—Double quadword (128-bit) operand in an XMM register or memory, specified as the right-most (second) operand in the instruction syntax.

2.5.2 Opcode Syntax

In addition to the notation shown above in “Mnemonic Syntax” on page 43, the following notation indicates the size and type of operands in the syntax of an instruction opcode:

- */digit*—Indicates that the ModRM byte specifies only one register or memory (*r/m*) operand. The digit is specified by the ModRM reg field and is used as an instruction-opcode extension. Valid digit values range from 0 to 7.
- */r*—Indicates that the ModRM byte specifies both a register operand and a reg/mem (register or memory) operand.
- *cb, cw, cd, cp*—Specifies a code-offset value and possibly a new code-segment register value. The value following the opcode is either one byte (*cb*), two bytes (*cw*), four bytes (*cd*), or six bytes (*cp*).

- *ib, iw, id*—Specifies an immediate-operand value. The opcode determines whether the value is signed or unsigned. The value following the opcode, ModRM, or SIB byte is either one byte (*ib*), two bytes (*iw*), or four bytes (*id*). Word and doubleword values start with the low-order byte.
- *+rb, +rw, +rd, +rq*—Specifies a register value that is added to the hexadecimal byte on the left, forming a one-byte opcode. The result is an instruction that operates on the register specified by the register code. Valid register-code values are shown in Table 2-2.
- *m64*—Specifies a quadword (64-bit) operand in memory.
- *+i*—Specifies an x87 floating-point stack operand, *ST(i)*. The value is used only with x87 floating-point instructions. It is added to the hexadecimal byte on the left, forming a one-byte opcode. Valid values range from 0 to 7.

Table 2-2. +rb, +rw, +rd, and +rq Register Value

REX.B Bit ¹	Value	Specified Register			
		+rb	+rw	+rd	+rq
0 or no REX Prefix	0	AL	AX	EAX	RAX
	1	CL	CX	ECX	RCX
	2	DL	DX	EDX	RDX
	3	BL	BX	EBX	RBX
	4	AH, SPL ¹	SP	ESP	RSP
	5	CH, BPL ¹	BP	EBP	RBP
	6	DH, SIL ¹	SI	ESI	RSI
	7	BH, DIL ¹	DI	EDI	RDI

1. See "REX Prefixes" on page 14.

Table 2-2. +rb, +rw, +rd, and +rq Register Value (continued)

REX.B Bit ¹	Value	Specified Register			
		+rb	+rw	+rd	+rq
1	0	R8B	R8W	R8D	R8
	1	R9B	R9W	R9D	R9
	2	R10B	R10W	R10D	R10
	3	R11B	R11W	R11D	R11
	4	R12B	R12W	R12D	R12
	5	R13B	R13W	R13D	R13
	6	R14B	R14W	R14D	R14
	7	R15B	R15W	R15D	R15

1. See "REX Prefixes" on page 14.

2.5.3 Pseudocode Definitions

Pseudocode examples are given for the actions of several complex instructions (for example, see “CALL (Near)” on page 87). The following definitions apply to all such pseudocode examples:

```

////////////////////////////////////////////////////////////////////////////////////////////////////////////////////////////////
// Basic Definitions
////////////////////////////////////////////////////////////////////////////////////////////////////////////////////////////////

// All comments start with these double slashes.

REAL_MODE      = (cr0.pe=0)
PROTECTED_MODE = ((cr0.pe=1) && (rflags.vm=0))
VIRTUAL_MODE   = ((cr0.pe=1) && (rflags.vm=1))
LEGACY_MODE    = (efer.lma=0)
LONG_MODE     = (efer.lma=1)
64BIT_MODE    = ((efer.lma=1) && (cs.L=1) && (cs.d=0))
COMPATIBILITY_MODE = (efer.lma=1) && (cs.L=0)
PAGING_ENABLED = (cr0.pg=1)
ALIGNMENT_CHECK_ENABLED = ((cr0.am=1) && (eflags.ac=1) && (cpl=3))
CPL           = the current privilege level (0-3)
OPERAND_SIZE  = 16, 32, or 64 (depending on current code and 66h/rex prefixes)
ADDRESS_SIZE  = 16, 32, or 64 (depending on current code and 67h prefixes)
STACK_SIZE   = 16, 32, or 64 (depending on current code and SS.attr.B)

old_RIP      = RIP at the start of current instruction
old_RSP      = RSP at the start of current instruction
old_RFLAGS   = RFLAGS at the start of the instruction
old_CS       = CS selector at the start of current instruction
old_DS       = DS selector at the start of current instruction
old_ES       = ES selector at the start of current instruction
old_FS       = FS selector at the start of current instruction
old_GS       = GS selector at the start of current instruction
old_SS       = SS selector at the start of current instruction

RIP          = the current RIP register
RSP          = the current RSP register
RBP          = the current RBP register
RFLAGS       = the current RFLAGS register
next_RIP     = RIP at start of next instruction

CS           = the current CS descriptor, including the subfields:
              sel base limit attr
SS           = the current SS descriptor, including the subfields:
              sel base limit attr

SRC          = the instruction's Source operand
DEST        = the instruction's Destination operand

temp_*      // 64-bit temporary register

```

```

temp*_desc      // temporary descriptor, with subfields:
                //     if it points to a block of memory: sel base limit attr
                //     if it's a gate descriptor: sel offset segment attr

NULL = 0x0000   // null selector is all zeros

// V,Z,A,S are integer variables, assigned a value when an instruction begins
// executing (they can be assigned a different value in the middle of an
// instruction, if needed)

V = 2 if OPERAND_SIZE=16
  4 if OPERAND_SIZE=32
  8 if OPERAND_SIZE=64

Z = 2 if OPERAND_SIZE=16
  4 if OPERAND_SIZE=32
  4 if OPERAND_SIZE=64

A = 2 if ADDRESS_SIZE=16
  4 if ADDRESS_SIZE=32
  8 if ADDRESS_SIZE=64

S = 2 if STACK_SIZE=16
  4 if STACK_SIZE=32
  8 if STACK_SIZE=64

////////////////////////////////////////////////////////////////
// Bit Range Inside a Register
////////////////////////////////////////////////////////////////

temp_data.[X:Y] // Bit X through Y in temp_data, with the other bits
                // in the register masked off.

////////////////////////////////////////////////////////////////
// Moving Data From One Register To Another
////////////////////////////////////////////////////////////////

temp_dest.b = temp_src // 1-byte move (copies lower 8 bits of temp_src to
                        // temp_dest, preserving the upper 56 bits of temp_dest)
temp_dest.w = temp_src // 2-byte move (copies lower 16 bits of temp_src to
                        // temp_dest, preserving the upper 48 bits of temp_dest)
temp_dest.d = temp_src // 4-byte move (copies lower 32 bits of temp_src to
                        // temp_dest, and zeros out the upper 32 bits of temp_dest)
temp_dest.q = temp_src // 8-byte move (copies all 64 bits of temp_src to
                        // temp_dest)

temp_dest.v = temp_src // 2-byte move if V=2,
                        // 4-byte move if V=4,

```



```

// 8-byte move if V=8
temp_dest.z = temp_src // 2-byte move if Z=2,
// 4-byte move if Z=4

temp_dest.a = temp_src // 2-byte move if A=2,
// 4-byte move if A=4,
// 8-byte move if A=8

temp_dest.s = temp_src // 2-byte move if S=2,
// 4-byte move if S=4,
// 8-byte move if S=8

/////////////////////////////////////////////////////////////////
// Bitwise Operations
/////////////////////////////////////////////////////////////////

temp = a AND b
temp = a OR b
temp = a XOR b
temp = NOT a
temp = a SHL b
temp = a SHR b

/////////////////////////////////////////////////////////////////
// Logical Operations
/////////////////////////////////////////////////////////////////

IF (FOO && BAR)
IF (FOO || BAR)
IF (FOO = BAR)
IF (FOO != BAR)
IF (FOO > BAR)
IF (FOO < BAR)
IF (FOO >= BAR)
IF (FOO <= BAR)

/////////////////////////////////////////////////////////////////
// IF-THEN-ELSE
/////////////////////////////////////////////////////////////////

IF (FOO)
...

IF (FOO)
...
ELSIF (BAR)
...
```

```

ELSE
    ...

IF ((FOO && BAR) || (CONE && HEAD))
    ...

////////////////////////////////////////////////////////////////
// Exceptions
////////////////////////////////////////////////////////////////

EXCEPTION [#GP(0)]          // error code in parenthesis
EXCEPTION [#UD]            // if no error code

possible exception types:

#DE      // Divide-By-Zero-Error Exception (Vector 0)
#DB      // Debug Exception (Vector 1)
#BP      // INT3 Breakpoint Exception (Vector 3)
#OF      // INTO Overflow Exception (Vector 4)
#BR      // Bound-Range Exception (Vector 5)
#UD      // Invalid-Opcode Exception (Vector 6)
#NM      // Device-Not-Available Exception (Vector 7)
#DF      // Double-Fault Exception (Vector 8)
#TS      // Invalid-TSS Exception (Vector 10)
#NP      // Segment-Not-Present Exception (Vector 11)
#SS      // Stack Exception (Vector 12)
#GP      // General-Protection Exception (Vector 13)
#PF      // Page-Fault Exception (Vector 14)
#MF      // x87 Floating-Point Exception-Pending (Vector 16)
#AC      // Alignment-Check Exception (Vector 17)
#MC      // Machine-Check Exception (Vector 18)
#XF      // SIMD Floating-Point Exception (Vector 19)

////////////////////////////////////////////////////////////////
// READ_MEM
// General memory read. This zero-extends the data to 64 bits and returns it.
////////////////////////////////////////////////////////////////

usage:
    temp = READ_MEM.x [seg:offset] // where x is one of {v, z, b, w, d, q}
                                   // and denotes the size of the memory read

definition:

    IF ((seg AND 0xFFFFC) = NULL) // GP fault for using a null segment to
                                   // reference memory
        EXCEPTION [#GP(0)]

    IF ((seg=CS) || (seg=DS) || (seg=ES) || (seg=FS) || (seg=GS))

```

```

        // CS,DS,ES,FS,GS check for segment limit or canonical
    IF ((!64BIT_MODE) && (offset is outside seg's limit))
        EXCEPTION [#GP(0)]
        // #GP fault for segment limit violation in non-64-bit mode
    IF ((64BIT_MODE) && (offset is non-canonical))
        EXCEPTION [#GP(0)]
        // #GP fault for non-canonical address in 64-bit mode
    ELSIF (seg=SS) // SS checks for segment limit or canonical
    IF ((!64BIT_MODE) && (offset is outside seg's limit))
        EXCEPTION [#SS(0)]
        // stack fault for segment limit violation in non-64-bit mode
    IF ((64BIT_MODE) && (offset is non-canonical))
        EXCEPTION [#SS(0)]
        // stack fault for non-canonical address in 64-bit mode
    ELSE // ((seg=GDT) || (seg=LDT) || (seg=IDT) || (seg=TSS))
        // GDT,LDT,IDT,TSS check for segment limit and canonical
    IF (offset > seg.limit)
        EXCEPTION [#GP(0)] // #GP fault for segment limit violation
        // in all modes
    IF ((LONG_MODE) && (offset is non-canonical))
        EXCEPTION [#GP(0)] // #GP fault for non-canonical address in long mode

    IF ((ALIGNMENT_CHECK_ENABLED) && (offset misaligned, considering its
        size and alignment))
        EXCEPTION [#AC(0)]

    IF ((64_bit_mode) && ((seg=CS) || (seg=DS) || (seg=ES) || (seg=SS))
        temp_linear = offset
    ELSE
        temp_linear = seg.base + offset

    IF ((PAGING_ENABLED) && (virtual-to-physical translation for temp_linear
        results in a page-protection violation))
        EXCEPTION [#PF(error_code)] // page fault for page-protection violation
        // (U/S violation, Reserved bit violation)

    IF ((PAGING_ENABLED) && (temp_linear is on a not-present page))
        EXCEPTION [#PF(error_code)] // page fault for not-present page

    temp_data = memory [temp_linear].x // zero-extends the data to 64
        // bits, and saves it in temp_data

    RETURN (temp_data) // return the zero-extended data

////////////////////////////////////
// WRITE_MEM // General memory write
////////////////////////////////////

usage:
    WRITE_MEM.x [seg:offset] = temp.x // where <X> is one of these:

```

```

// {V, Z, B, W, D, Q} and denotes the
// size of the memory write

```

definition:

```

IF ((seg & 0xFFFFC)= NULL) // GP fault for using a null segment
    EXCEPTION [#GP(0)] // to reference memory

IF (seg isn't writable) // GP fault for writing to a read-only segment
    EXCEPTION [#GP(0)]

IF ((seg=CS) || (seg=DS) || (seg=ES) || (seg=FS) || (seg=GS))
    // CS,DS,ES,FS,GS check for segment limit or canonical
    IF ((!64BIT_MODE) && (offset is outside seg's limit))
        EXCEPTION [#GP(0)]
        // #GP fault for segment limit violation in non-64-bit mode
    IF ((64BIT_MODE) && (offset is non-canonical))
        EXCEPTION [#GP(0)]
        // #GP fault for non-canonical address in 64-bit mode
ELIF (seg=SS) // SS checks for segment limit or canonical
    IF ((!64BIT_MODE) && (offset is outside seg's limit))
        EXCEPTION [#SS(0)]
        // stack fault for segment limit violation in non-64-bit mode
    IF ((64BIT_MODE) && (offset is non-canonical))
        EXCEPTION [#SS(0)]
        // stack fault for non-canonical address in 64-bit mode
ELSE // ((seg=GDT) || (seg=LDT) || (seg=IDT) || (seg=TSS))
    // GDT,LDT,IDT,TSS check for segment limit and canonical
    IF (offset > seg.limit)
        EXCEPTION [#GP(0)]
        // #GP fault for segment limit violation in all modes
    IF ((LONG_MODE) && (offset is non-canonical))
        EXCEPTION [#GP(0)]
        // #GP fault for non-canonical address in long mode

IF ((ALIGNMENT_CHECK_ENABLED) && (offset is misaligned, considering
    its size and alignment))
    EXCEPTION [#AC(0)]

IF ((64_bit_mode) && ((seg=CS) || (seg=DS) || (seg=ES) || (seg=SS))
    temp_linear = offset
ELSE
    temp_linear = seg.base + offset

IF ((PAGING_ENABLED) && (the virtual-to-physical translation for
    temp_linear results in a page-protection violation))
{
    EXCEPTION [#PF(error_code)]
        // page fault for page-protection violation
        // (U/S violation, Reserved bit violation)
}

```

```

}

IF ((PAGING_ENABLED) && (temp_linear is on a not-present page))
    EXCEPTION [#PF(error_code)]    // page fault for not-present page

memory [temp_linear].x = temp.x    // write the bytes to memory

////////////////////////////////////
// PUSH // Write data to the stack
////////////////////////////////////

usage:
    PUSH.x temp                    // where x is one of these: {v, z, b, w, d, q} and
                                  // denotes the size of the push

definition:

    WRITE_MEM.x [SS:RSP.s - X] = temp.x    // write to the stack
    RSP.s = RSP - X                        // point rsp to the data just written

////////////////////////////////////
// POP // Read data from the stack, zero-extend it to 64 bits
////////////////////////////////////

usage:
    POP.x temp                     // where x is one of these: {v, z, b, w, d, q} and
                                  // denotes the size of the pop

definition:

    temp = READ_MEM.x [SS:RSP.s]          // read from the stack
    RSP.s = RSP + X                       // point rsp above the data just written

////////////////////////////////////
// READ_DESCRIPTOR // Read 8-byte descriptor from GDT/LDT, return the descriptor
////////////////////////////////////

usage:
    temp_descriptor = READ_DESCRIPTOR (selector, chktype)
    // chktype field is one of the following:
    // cs_chk      used for far call and far jump
    // clg_chk     used when reading CS for far call or far jump through call gate
    // ss_chk      used when reading SS
    // iret_chk    used when reading CS for IRET or RETF
    // intcs_chk   used when reading the CS for interrupts and exceptions

definition:

```

```

temp_offset = selector AND 0xfff8 // upper 13 bits give an offset
                                // in the descriptor table

IF (selector.TI = 0)             // read 8 bytes from the gdt, split it into
                                // (base,limit,attr) if the type bits
    temp_desc = READ_MEM.q [gdt:temp_offset]
                                // indicate a block of memory, or split
                                // it into (segment,offset,attr)
                                // if the type bits indicate
                                // a gate, and save the result in temp_desc
ELSE
    temp_desc = READ_MEM.q [ldt:temp_offset]
                                // read 8 bytes from the ldt, split it into
                                // (base,limit,attr) if the type bits
                                // indicate a block of memory, or split
                                // it into (segment,offset,attr) if the type
                                // bits indicate a gate, and save the result
                                // in temp_desc

IF (selector.rpl or temp_desc.attr.dpl is illegal for the current mode/cpl)
    EXCEPTION [#GP(selector)]

IF (temp_desc.attr.type is illegal for the current mode/chktype)
    EXCEPTION [#GP(selector)]

IF (temp_desc.attr.p=0)
    EXCEPTION [#NP(selector)]

RETURN (temp_desc)

////////////////////////////////////////////////////////////////////////////////////////////////////////////////////////////////
// READ_IDT // Read an 8-byte descriptor from the IDT, return the descriptor
////////////////////////////////////////////////////////////////////////////////////////////////////////////////////////////////

usage:
    temp_idt_desc = READ_IDT (vector)
                                // "vector" is the interrupt vector number

definition:

IF (LONG_MODE)                 // long-mode idt descriptors are 16 bytes long
    temp_offset = vector*16
ELSE // (LEGACY_MODE) legacy-protected-mode idt descriptors are 8 bytes long
    temp_offset = vector*8

temp_desc = READ_MEM.q [idt:temp_offset]
                                // read 8 bytes from the idt, split it into
                                // (segment,offset,attr), and save it in temp_desc

IF (temp_desc.attr.dpl is illegal for the current mode/cpl)

```

```

        // exception, with error code that indicates this idt gate
    EXCEPTION [#GP(vector*8+2)]

    IF (temp_desc.attr.type is illegal for the current mode)
        // exception, with error code that indicates this idt gate
    EXCEPTION [#GP(vector*8+2)]

    IF (temp_desc.attr.p=0)
    EXCEPTION [#NP(vector*8+2)]
        // segment-not-present exception, with an error code that
        // indicates this idt gate

    RETURN (temp_desc)

////////////////////////////////////
// READ_INNER_LEVEL_STACK_POINTER
// Read a new stack pointer (rsp or ss:esp) from the tss
////////////////////////////////////

usage:
    temp_SS_desc:temp_RSP = READ_INNER_LEVEL_STACK_POINTER (new_cp1, ist_index)

definition:

    IF (LONG_MODE)
    {
        IF (ist_index>0)
            // if IST is selected, read an ISTn stack pointer from the tss
            temp_RSP = READ_MEM.q [tss:ist_index*8+28]
        ELSE // (ist_index=0)
            // otherwise read an RSPn stack pointer from the tss
            temp_RSP = READ_MEM.q [tss:new_cp1*8+4]

        temp_SS_desc.sel = NULL + new_cp1
            // in long mode, changing to lower cp1 sets SS.sel to
            // NULL+new_cp1
    }
    ELSE // (LEGACY_MODE)
    {
        temp_RSP = READ_MEM.d [tss:new_cp1*8+4] // read ESPn from the tss
        temp_sel = READ_MEM.d [tss:new_cp1*8+8] // read SSn from the tss
        temp_SS_desc = READ_DESCRIPTOR (temp_sel, ss_chk)
    }

    return (temp_RSP:temp_SS_desc)

////////////////////////////////////
// READ_BIT_ARRAY // Read 1 bit from a bit array in memory
////////////////////////////////////

```

usage:

```
temp_value = READ_BIT_ARRAY ([mem], bit_number)
```

definition:

```
temp_BYTE = READ_MEM.b [mem + (bit_number SHR 3)]  
           // read the byte containing the bit  
  
temp_BIT = temp_BYTE SHR (bit_number & 7)  
          // shift the requested bit position into bit 0  
  
return (temp_BIT & 0x01) // return '0' or '1'
```

3 General-Purpose Instruction Reference

This chapter describes the function, mnemonic syntax, opcodes, affected flags, and possible exceptions generated by the general-purpose instructions. General-purpose instructions are used in basic software execution. Most of these instructions load, store, or operate on data located in the general-purpose registers (GPRs), in memory, or in both. The remaining instructions are used to alter the sequential flow of the program by branching to other locations within the program, or to entirely different programs. With the exception of the MOVD, MOVMSKPD and MOVMSKPS instructions, which operate on MMX/XMM registers, the instructions within the category of general-purpose instructions do not operate on any other register set.

Most general-purpose instructions are supported in all hardware implementations of the AMD64 architecture. The following general-purpose instructions are implemented only if their associated CPUID function bit is set:

- CMPXCHG8B, indicated by bit 8 of CPUID standard function 1 and extended function 8000_0001h.
- CMOV_{cc} (conditional moves), indicated by bit 15 of CPUID standard function 1 and extended function 8000_0001h.
- CLFLUSH, indicated by bit 19 of CPUID standard function 1.
- PREFETCH, indicated by bit 31 of CPUID extended function 8000_0001h.
- MOVD, indicated by bits 25 (MMX™) and 26 (XMM) of CPUID standard function 1.
- MOVNTI, indicated by bit 26 of CPUID standard function 1.
- SFENCE, indicated by bit 25 of CPUID standard function 1.
- MFENCE, LFENCE, indicated by bit 26 of CPUID standard function 1.
- Long Mode instructions, indicated by bit 29 of CPUID extended function 8000_0001h.

The general-purpose instructions can be used in legacy mode or 64-bit long mode. Compilation of general-purpose programs for execution in 64-bit long mode offers three primary advantages: access to the eight extended, 64-bit general-purpose registers

(for a register set consisting of GPR0–GPR15), access to the 64-bit virtual address space, and access to the RIP-relative addressing mode.

For further information about the general-purpose instructions and register resources, see:

- “General-Purpose Programming” in Volume 1.
- “Summary of Registers and Data Types” on page 30.
- “Notation” on page 43.
- “Instruction Prefixes” on page 3.
- Appendix B, “General-Purpose Instructions in 64-Bit Mode.” In particular, see “General Rules for 64-Bit Mode” on page 405.

AAA ASCII Adjust After Addition

Adjusts the value in the AL register to an unpacked BCD value. Use the AAA instruction after using the ADD instruction to add two unpacked BCD numbers.

If the value in the lower nibble of AL is greater than 9 or the AF flag is set to 1, the instruction increments the AH register, adds 6 to the AL register, and sets the CF and AF flags to 1. Otherwise, it does not change the AH register and clears the CF and AF flags to 0. In either case, AAA clears bits 7–4 of the AL register, leaving the correct decimal digit in bits 3–0.

This instruction also makes it possible to add ASCII numbers without having to mask off the upper nibble ‘3’.

Using this instruction in 64-bit mode generates an invalid-opcode exception.

Mnemonic	Opcode	Description
AAA	37	Create an unpacked BCD number. (Invalid in 64-bit mode.)

Related Instructions

AAD, AAM, AAS

rFLAGS Affected

ID	VIP	VIF	AC	VM	RF	NT	IOPL	OF	DF	IF	TF	SF	ZF	AF	PF	CF
								U				U	U	M	U	M
21	20	19	18	17	16	14	13–12	11	10	9	8	7	6	4	2	0

Note: Bits 31–22, 15, 5, 3, and 1 are reserved. A flag set to 1 or cleared to 0 is M (modified). Unaffected flags are blank. Undefined flags are U.

Exceptions

Exception	Real	Virtual 8086	Protected	Cause of Exception
Invalid opcode, #UD			X	This instruction was executed in 64-bit mode.

AAD**ASCII Adjust Before Division**

Converts two unpacked BCD digits in the AL (least significant) and AH (most significant) registers to a single binary value in the AL register using the following formula:

$$AL = ((10d * AH) + (AL))$$

After the conversion, AH is cleared to 00h.

In most modern assemblers, the AAD instruction adjusts from base-10 values. However, by coding the instruction directly in binary, it can adjust from any base specified by the immediate byte value (*ib*) suffixed onto the D5h opcode. For example, code D508h for octal, D50Ah for decimal, and D50Ch for duodecimal (base 12).

Using this instruction in 64-bit mode generates an invalid-opcode exception.

Mnemonic	Opcode	Description
AAD	D5 0A	Adjust two BCD digits in AL and AH. (Invalid in 64-bit mode.)
(None)	D5 <i>ib</i>	Adjust two BCD digits to the immediate byte base. (Invalid in 64-bit mode.)

Related Instructions

AAA, AAM, AAS

rFLAGS Affected

ID	VIP	VIF	AC	VM	RF	NT	IOPL	OF	DF	IF	TF	SF	ZF	AF	PF	CF
								U				M	M	U	M	U
21	20	19	18	17	16	14	13–12	11	10	9	8	7	6	4	2	0

Note: Bits 31–22, 15, 5, 3, and 1 are reserved. A flag set to 1 or cleared to 0 is M (modified). Unaffected flags are blank. Undefined flags are U.

Exceptions

Exception	Real	Virtual 8086	Protected	Cause of Exception
Invalid opcode, #UD			X	This instruction was executed in 64-bit mode.

AAM**ASCII Adjust After Multiply**

Converts the value in the AL register from binary to two unpacked BCD digits in the AH (most significant) and AL (least significant) registers using the following formula:

$$\begin{aligned} \text{AH} &= (\text{AL}/10\text{d}) \\ \text{AL} &= (\text{AL} \bmod 10\text{d}). \end{aligned}$$

In most modern assemblers, the AAM instruction adjusts to base-10 values. However, by coding the instruction directly in binary, it can adjust to any base specified by the immediate byte value (*ib*) suffixed onto the D4h opcode. For example, code D408h for octal, D40Ah for decimal, and D40Ch for duodecimal (base 12).

Using this instruction in 64-bit mode generates an invalid-opcode exception.

Mnemonic	Opcode	Description
AAM	D4 0A	Create a pair of unpacked BCD values in AH and AL. (Invalid in 64-bit mode.)
(None)	D4 <i>ib</i>	Create a pair of unpacked values to the immediate byte base. (Invalid in 64-bit mode.)

Related Instructions

AAA, AAD, AAS

rFLAGS Affected

ID	VIP	VIF	AC	VM	RF	NT	IOPL	OF	DF	IF	TF	SF	ZF	AF	PF	CF
								U				M	M	U	M	U
21	20	19	18	17	16	14	13–12	11	10	9	8	7	6	4	2	0

Note: Bits 31–22, 15, 5, 3, and 1 are reserved. A flag set to 1 or cleared to 0 is M. Unaffected flags are blank. Undefined flags are U.

Exceptions

Exception	Real	Virtual 8086	Protected	Cause of Exception
Divide by zero, #DE	X	X	X	8-bit immediate value was 0.
Invalid opcode, #UD			X	This instruction was executed in 64-bit mode.

AAS ASCII Adjust After Subtraction

Adjusts the value in the AL register to an unpacked BCD value. Use the AAS instruction after using the SUB instruction to subtract two unpacked BCD numbers.

If the value in AL is greater than 9 or the AF flag is set to 1, the instruction decrements the value in AH, subtracts 6 from the AL register, and sets the CF and AF flags to 1. Otherwise, it clears the CF and AF flags and the AH register is unchanged. In either case, the instruction clears bits 7–4 of the AL register, leaving the correct decimal digit in bits 3–0.

Using this instruction in 64-bit mode generates an invalid-opcode exception.

Mnemonic	Opcode	Description
AAS	3F	Create an unpacked BCD number from the contents of the AL register. (Invalid in 64-bit mode.)

Related Instructions

AAA, AAD, AAM

rFLAGS Affected

ID	VIP	VIF	AC	VM	RF	NT	IOPL	OF	DF	IF	TF	SF	ZF	AF	PF	CF
								U				U	U	M	U	M
21	20	19	18	17	16	14	13–12	11	10	9	8	7	6	4	2	0

Note: Bits 31–22, 15, 5, 3, and 1 are reserved. A flag set to 1 or cleared to 0 is M (modified). Unaffected flags are blank. Undefined flags are U.

Exceptions

Exception	Real	Virtual 8086	Protected	Cause of Exception
Invalid opcode, #UD			X	This instruction was executed in 64-bit mode.

ADC Add with Carry

Adds the carry flag (CF), the value in a register or memory location (first operand), and an immediate value or the value in a register or memory location (second operand), and stores the result in the first operand location. The instruction cannot add two memory operands. The CF flag indicates a pending carry from a previous addition operation. The instruction sign-extends an immediate value to the length of the destination register or memory location.

This instruction evaluates the result for both signed and unsigned data types and sets the OF and CF flags to indicate a carry in a signed or unsigned result, respectively. It sets the SF flag to indicate the sign of a signed result.

Use the ADC instruction after an ADD instruction as part of a multibyte or multiword addition.

The forms of the ADC instruction that write to memory support the LOCK prefix. For details about the LOCK prefix, see “Lock Prefix” on page 10.

Mnemonic	Opcode	Description
ADC AL, <i>imm8</i>	14 <i>ib</i>	Add <i>imm8</i> to AL + CF.
ADC AX, <i>imm16</i>	15 <i>iw</i>	Add <i>imm16</i> to AX + CF.
ADC EAX, <i>imm32</i>	15 <i>id</i>	Add <i>imm32</i> to EAX + CF.
ADC RAX, <i>imm32</i>	15 <i>id</i>	Add sign-extended <i>imm32</i> to RAX + CF.
ADC <i>reg/mem8</i> , <i>imm8</i>	80 /2 <i>ib</i>	Add <i>imm8</i> to <i>reg/mem8</i> + CF.
ADC <i>reg/mem16</i> , <i>imm16</i>	81 /2 <i>iw</i>	Add <i>imm16</i> to <i>reg/mem16</i> + CF.
ADC <i>reg/mem32</i> , <i>imm32</i>	81 /2 <i>id</i>	Add <i>imm32</i> to <i>reg/mem32</i> + CF.
ADC <i>reg/mem64</i> , <i>imm32</i>	81 /2 <i>id</i>	Add sign-extended <i>imm32</i> to <i>reg/mem64</i> + CF.
ADC <i>reg/mem16</i> , <i>imm8</i>	83 /2 <i>ib</i>	Add sign-extended <i>imm8</i> to <i>reg/mem16</i> + CF.
ADC <i>reg/mem32</i> , <i>imm8</i>	83 /2 <i>ib</i>	Add sign-extended <i>imm8</i> to <i>reg/mem32</i> + CF.
ADC <i>reg/mem64</i> , <i>imm8</i>	83 /2 <i>ib</i>	Add sign-extended <i>imm8</i> to <i>reg/mem64</i> + CF.
ADC <i>reg/mem8</i> , <i>reg8</i>	10 / <i>r</i>	Add <i>reg8</i> to <i>reg/mem8</i> + CF
ADC <i>reg/mem16</i> , <i>reg16</i>	11 / <i>r</i>	Add <i>reg16</i> to <i>reg/mem16</i> + CF.
ADC <i>reg/mem32</i> , <i>reg32</i>	11 / <i>r</i>	Add <i>reg32</i> to <i>reg/mem32</i> + CF.

Mnemonic	Opcode	Description
ADC <i>reg/mem64, reg64</i>	11 /r	Add <i>reg64</i> to <i>reg/mem64</i> + CF.
ADC <i>reg8, reg/mem8</i>	12 /r	Add <i>reg/mem8</i> to <i>reg8</i> + CF.
ADC <i>reg16, reg/mem16</i>	13 /r	Add <i>reg/mem16</i> to <i>reg16</i> + CF.
ADC <i>reg32, reg/mem32</i>	13 /r	Add <i>reg/mem32</i> to <i>reg32</i> + CF.
ADC <i>reg64, reg/mem64</i>	13 /r	Add <i>reg/mem64</i> to <i>reg64</i> + CF.

Related Instructions

ADD, SBB, SUB

rFLAGS Affected

ID	VIP	VIF	AC	VM	RF	NT	IOPL	OF	DF	IF	TF	SF	ZF	AF	PF	CF
								M				M	M	M	M	M
21	20	19	18	17	16	14	13–12	11	10	9	8	7	6	4	2	0

Note: Bits 31–22, 15, 5, 3, and 1 are reserved. A flag set to 1 or cleared to 0 is M (modified). Unaffected flags are blank. Undefined flags are U.

Exceptions

Exception	Real	Virtual 8086	Protected	Cause of Exception
Stack, #SS	X	X	X	A memory address exceeded the stack segment limit or was non-canonical.
General protection, #GP	X	X	X	A memory address exceeded a data segment limit or was non-canonical.
			X	The destination operand was in a non-writable segment.
			X	A null data segment was used to reference memory.
Page fault, #PF		X	X	A page fault resulted from the execution of the instruction.
Alignment check, #AC		X	X	An unaligned memory reference was performed while alignment checking was enabled.

ADD Signed or Unsigned Add

Adds the value in a register or memory location (first operand) and an immediate value or the value in a register a memory location (second operand), and stores the result in the first operand location. The instruction cannot add two memory operands. The instruction sign-extends an immediate value to the length of the destination register or memory operand.

This instruction evaluates the result for both signed and unsigned data types and sets the OF and CF flags to indicate a carry in a signed or unsigned result, respectively. It sets the SF flag to indicate the sign of a signed result.

The forms of the ADD instruction that write to memory support the LOCK prefix. For details about the LOCK prefix, see “Lock Prefix” on page 10.

Mnemonic	Opcode	Description
ADD AL, <i>imm8</i>	04 <i>ib</i>	Add <i>imm8</i> to AL.
ADD AX, <i>imm16</i>	05 <i>iw</i>	Add <i>imm16</i> to AX.
ADD EAX, <i>imm32</i>	05 <i>id</i>	Add <i>imm32</i> to EAX.
ADD RAX, <i>imm32</i>	05 <i>id</i>	Add sign-extended <i>imm32</i> to RAX.
ADD <i>reg/mem8</i> , <i>imm8</i>	80 /0 <i>ib</i>	Add <i>imm8</i> to <i>reg/mem8</i> .
ADD <i>reg/mem16</i> , <i>imm16</i>	81 /0 <i>iw</i>	Add <i>imm16</i> to <i>reg/mem16</i> .
ADD <i>reg/mem32</i> , <i>imm32</i>	81 /0 <i>id</i>	Add <i>imm32</i> to <i>reg/mem32</i> .
ADD <i>reg/mem64</i> , <i>imm32</i>	81 /0 <i>id</i>	Add sign-extended <i>imm32</i> to <i>reg/mem64</i> .
ADD <i>reg/mem16</i> , <i>imm8</i>	83 /0 <i>ib</i>	Add sign-extended <i>imm8</i> to <i>reg/mem16</i> .
ADD <i>reg/mem32</i> , <i>imm8</i>	83 /0 <i>ib</i>	Add sign-extended <i>imm8</i> to <i>reg/mem32</i> .
ADD <i>reg/mem64</i> , <i>imm8</i>	83 /0 <i>ib</i>	Add sign-extended <i>imm8</i> to <i>reg/mem64</i> .
ADD <i>reg/mem8</i> , <i>reg8</i>	00 /r	Add <i>reg8</i> to <i>reg/mem8</i> .
ADD <i>reg/mem16</i> , <i>reg16</i>	01 /r	Add <i>reg16</i> to <i>reg/mem16</i> .
ADD <i>reg/mem32</i> , <i>reg32</i>	01 /r	Add <i>reg32</i> to <i>reg/mem32</i> .
ADD <i>reg/mem64</i> , <i>reg64</i>	01 /r	Add <i>reg64</i> to <i>reg/mem64</i> .
ADD <i>reg8</i> , <i>reg/mem8</i>	02 /r	Add <i>reg/mem8</i> to <i>reg8</i> .

Mnemonic	Opcode	Description
ADD reg16, reg/mem16	03 /r	Add reg/mem16 to reg16.
ADD reg32, reg/mem32	03 /r	Add reg/mem32 to reg32.
ADD reg64, reg/mem64	03 /r	Add reg/mem64 to reg64.

Related Instructions

ADC, SBB, SUB

rFLAGS Affected

ID	VIP	VIF	AC	VM	RF	NT	IOPL	OF	DF	IF	TF	SF	ZF	AF	PF	CF
								M				M	M	M	M	M
21	20	19	18	17	16	14	13–12	11	10	9	8	7	6	4	2	0

Note: Bits 31–22, 15, 5, 3, and 1 are reserved. A flag set to 1 or cleared to 0 is M (modified). Unaffected flags are blank. Undefined flags are U.

Exceptions

Exception	Real	Virtual 8086	Protected	Cause of Exception
Stack, #SS	X	X	X	A memory address exceeded the stack segment limit or was non-canonical.
General protection, #GP	X	X	X	A memory address exceeded a data segment limit or was non-canonical.
			X	The destination operand was in a non-writable segment.
			X	A null data segment was used to reference memory.
Page fault, #PF		X	X	A page fault resulted from the execution of the instruction.
Alignment check, #AC		X	X	An unaligned memory reference was performed while alignment checking was enabled.

AND Logical AND

Performs a bitwise AND operation on the value in a register or memory location (first operand) and an immediate value or the value in a register or memory location (second operand), and stores the result in the first operand location. The instruction cannot AND two memory operands.

The instruction sets each bit of the result to 1 if the corresponding bit of both operands is set; otherwise, it clears the bit to 0. The following table shows the truth table for the AND operation:

X	Y	X AND Y
0	0	0
0	1	0
1	0	0
1	1	1

The forms of the AND instruction that write to memory support the LOCK prefix. For details about the LOCK prefix, see “Lock Prefix” on page 10.

Mnemonic	Opcode	Description
AND AL, <i>imm8</i>	24 <i>ib</i>	AND the contents of AL with an immediate 8-bit value and store the result in AL.
AND AX, <i>imm16</i>	25 <i>iv</i>	AND the contents of AX with an immediate 16-bit value and store the result in AX.
AND EAX, <i>imm32</i>	25 <i>id</i>	AND the contents of EAX with an immediate 32-bit value and store the result in EAX.
AND RAX, <i>imm32</i>	25 <i>id</i>	AND the contents of RAX with a sign-extended immediate 32-bit value and store the result in RAX.
AND <i>reg/mem8</i> , <i>imm8</i>	80 /4 <i>ib</i>	AND the contents of <i>reg/mem8</i> with <i>imm8</i> .
AND <i>reg/mem16</i> , <i>imm16</i>	81 /4 <i>iv</i>	AND the contents of <i>reg/mem16</i> with <i>imm16</i> .
AND <i>reg/mem32</i> , <i>imm32</i>	81 /4 <i>id</i>	AND the contents of <i>reg/mem32</i> with <i>imm32</i> .
AND <i>reg/mem64</i> , <i>imm32</i>	81 /4 <i>id</i>	AND the contents of <i>reg/mem64</i> with sign-extended <i>imm32</i> .

Mnemonic	Opcode	Description
AND <i>reg/mem16, imm8</i>	83 /4 <i>ib</i>	AND the contents of <i>reg/mem16</i> with a sign-extended 8-bit value.
AND <i>reg/mem32, imm8</i>	83 /4 <i>ib</i>	AND the contents of <i>reg/mem32</i> with a sign-extended 8-bit value.
AND <i>reg/mem64, imm8</i>	83 /4 <i>ib</i>	AND the contents of <i>reg/mem64</i> with a sign-extended 8-bit value.
AND <i>reg/mem8, reg8</i>	20 / <i>r</i>	AND the contents of an 8-bit register or memory location with the contents of an 8-bit register.
AND <i>reg/mem16, reg16</i>	21 / <i>r</i>	AND the contents of a 16-bit register or memory location with the contents of a 16-bit register.
AND <i>reg/mem32, reg32</i>	21 / <i>r</i>	AND the contents of a 32-bit register or memory location with the contents of a 32-bit register.
AND <i>reg/mem64, reg64</i>	21 / <i>r</i>	AND the contents of a 64-bit register or memory location with the contents of a 64-bit register.
AND <i>reg8, reg/mem8</i>	22 / <i>r</i>	AND the contents of an 8-bit register with the contents of an 8-bit memory location or register.
AND <i>reg16, reg/mem16</i>	23 / <i>r</i>	AND the contents of a 16-bit register with the contents of a 16-bit memory location or register.
AND <i>reg32, reg/mem32</i>	23 / <i>r</i>	AND the contents of a 32-bit register with the contents of a 32-bit memory location or register.
AND <i>reg64, reg/mem64</i>	23 / <i>r</i>	AND the contents of a 64-bit register with the contents of a 64-bit memory location or register.

Related Instructions

TEST, OR, NOT, NEG, XOR

rFLAGS Affected

ID	VIP	VIF	AC	VM	RF	NT	IOPL	OF	DF	IF	TF	SF	ZF	AF	PF	CF
								0				M	M	U	M	0
21	20	19	18	17	16	14	13–12	11	10	9	8	7	6	4	2	0

Note: Bits 31–22, 15, 5, 3, and 1 are reserved. A flag set to 1 or cleared to 0 is M (modified). Unaffected flags are blank. Undefined flags are U.

Exceptions

Exception	Real	Virtual 8086	Protected	Cause of Exception
Stack, #SS	X	X	X	A memory address exceeded the stack segment limit or was non-canonical.
General protection, #GP	X	X	X	A memory address exceeded a data segment limit or was non-canonical.
			X	The destination operand was in a non-writable segment.
			X	A null data segment was used to reference memory.
Page fault, #PF		X	X	A page fault resulted from the execution of the instruction.
Alignment check, #AC		X	X	An unaligned memory reference was performed while alignment checking was enabled.

BOUND Check Array Bounds

Checks whether an array index (first operand) is within the bounds of an array (second operand). The array index is a signed integer in the specified register. If the operand-size attribute is 16, the array operand is a memory location containing a pair of signed word-integers; if the operand-size attribute is 32, the array operand is a pair of signed doubleword-integers. The first word or doubleword specifies the lower bound of the array and the second word or doubleword specifies the upper bound.

The array index must be greater than or equal to the lower bound and less than or equal to the upper bound. If the index is not within the specified bounds, the processor generates a BOUND range-exceeded exception (#BR).

The bounds of an array, consisting of two words or doublewords containing the lower and upper limits of the array, usually reside in a data structure just before the array itself, making the limits addressable through a constant offset from the beginning of the array. With the address of the array in a register, this practice reduces the number of bus cycles required to determine the effective address of the array bounds.

Using this instruction in 64-bit mode generates an invalid-opcode exception.

Mnemonic	Opcode	Description
BOUND <i>reg16, mem16&mem16</i>	62/r	Test whether a 16-bit array index is within the bounds specified by the two 16-bit values in <i>mem16&mem16</i> . (Invalid in 64-bit mode.)
BOUND <i>reg32, mem32&mem32</i>	62/r	Test whether a 32-bit array index is within the bounds specified by the two 32-bit values in <i>mem32&mem32</i> . (Invalid in 64-bit mode.)

Related Instructions

INT, INT3, INTO

rFLAGS Affected

None

Exceptions

Exception	Real	Virtual 8086	Protected	Cause of Exception
Bound range, #BR	X	X	X	The bound range was exceeded.
Invalid opcode, #UD	X	X	X	The source operand was a register.
			X	Instruction was executed in 64-bit mode.
Stack, #SS	X	X	X	A memory address exceeded the stack segment limit
General protection, #GP	X	X	X	A memory address exceeded a data segment limit.
			X	A null data segment was used to reference memory.
Page fault, #PF		X	X	A page fault resulted from the execution of the instruction.
Alignment check, #AC		X	X	An unaligned memory reference was performed while alignment checking was enabled.

BSF Bit Scan Forward

Searches the value in a register or a memory location (second operand) for the least-significant set bit. If a set bit is found, the instruction clears the zero flag (ZF) and stores the index of the least-significant set bit in a destination register (first operand). If the second operand contains 0, the instruction sets ZF to 1 and does not change the contents of the destination register. The bit index is an unsigned offset from bit 0 of the searched value.

Mnemonic	Opcode	Description
BSF <i>reg16, reg/mem16</i>	OF BC /r	Bit scan forward on the contents of <i>reg/mem16</i> .
BSF <i>reg32, reg/mem32</i>	OF BC /r	Bit scan forward on the contents of <i>reg/mem32</i> .
BSF <i>reg64, reg/mem64</i>	OF BC /r	Bit scan forward on the contents of <i>reg/mem64</i> .

Related Instructions

BSR

rFLAGS Affected

ID	VIP	VIF	AC	VM	RF	NT	IOPL	OF	DF	IF	TF	SF	ZF	AF	PF	CF
								U				U	M	U	U	U
21	20	19	18	17	16	14	13–12	11	10	9	8	7	6	4	2	0

Note: Bits 31–22, 15, 5, 3, and 1 are reserved. A flag set to 1 or cleared to 0 is M (modified). Unaffected flags are blank. Undefined flags are U.

Exceptions

Exception	Real	Virtual 8086	Protected	Cause of Exception
Stack, #SS	X	X	X	A memory address exceeded the stack segment limit or was non-canonical.
General protection, #GP	X	X	X	A memory address exceeded a data segment limit or was non-canonical.
			X	A null data segment was used to reference memory.

Exception	Real	Virtual 8086	Protected	Cause of Exception
Page fault, #PF		X	X	A page fault resulted from the execution of the instruction.
Alignment check, #AC		X	X	An unaligned memory reference was performed while alignment checking was enabled.

BSR Bit Scan Reverse

Searches the value in a register or a memory location (second operand) for the most-significant set bit. If a set bit is found, the instruction clears the zero flag (ZF) and stores the index of the most-significant set bit in a destination register (first operand). If the second operand contains 0, the instruction sets ZF to 1 and does not change the contents of the destination register. The bit index is an unsigned offset from bit 0 of the searched value.

Mnemonic	Opcode	Description
BSR <i>reg16, reg/mem16</i>	OF BD /r	Bit scan reverse on the contents of <i>reg/mem16</i> .
BSR <i>reg32, reg/mem32</i>	OF BD /r	Bit scan reverse on the contents of <i>reg/mem32</i> .
BSR <i>reg64, reg/mem64</i>	OF BD /r	Bit scan reverse on the contents of <i>reg/mem64</i> .

Related Instructions

BSF

rFLAGS Affected

ID	VIP	VIF	AC	VM	RF	NT	IOPL	OF	DF	IF	TF	SF	ZF	AF	PF	CF
								U				U	M	U	U	U
21	20	19	18	17	16	14	13–12	11	10	9	8	7	6	4	2	0

Note: Bits 31–22, 15, 5, 3, and 1 are reserved. A flag set to 1 or cleared to 0 is M (modified). Unaffected flags are blank. Undefined flags are U.

Exceptions

Exception	Real	Virtual 8086	Protected	Cause of Exception
Stack, #SS	X	X	X	A memory address exceeded the stack segment limit or was non-canonical.
General protection, #GP	X	X	X	A memory address exceeded the data segment limit or was non-canonical.
			X	A null data segment was used to reference memory.

Exception	Real	Virtual 8086	Protected	Cause of Exception
Page fault, #PF		X	X	A page fault resulted from the execution of the instruction.
Alignment check, #AC		X	X	An unaligned memory reference was performed while alignment checking was enabled.

BSWAP Byte Swap

Reverses the byte order of the specified register. This action converts the contents of the register from little endian to big endian or vice versa. In a doubleword, bits 7–0 are exchanged with bits 31–24, and bits 15–8 are exchanged with bits 23–16. In a quadword, bits 7–0 are exchanged with bits 63–56, bits 15–8 with bits 55–48, bits 23–16 with bits 47–40, and bits 31–24 with bits 39–32. A subsequent use of the BSWAP instruction with the same operand restores the original value of the operand.

The result of applying the BSWAP instruction to a 16-bit register is undefined. To swap the bytes of a 16-bit register, use the XCHG instruction and specify the respective byte halves of the 16-bit register as the two operands. For example, to swap the bytes of AX, use XCHG AL, AH.

Mnemonic	Opcode	Description
BSWAP <i>reg32</i>	0F C8 <i>rd</i>	Reverse the byte order of <i>reg32</i> .
BSWAP <i>reg64</i>	0F C8 <i>rd</i>	Reverse the byte order of <i>reg64</i> .

Related Instructions

XCHG

rFLAGS Affected

None

Exceptions

None

BT Bit Test

Copies a bit, specified by a bit index in a register or 8-bit immediate value (second operand), from a bit string (first operand), also called the bit base, to the carry flag (CF) of the rFLAGS register.

If the bit base operand is a register, the instruction uses the modulo 16, 32, or 64 (depending on the operand size) of the bit index to select a bit in the register.

If the bit base operand is a memory location, bit 0 of the byte at the specified address is the bit base of the bit string. If the bit index is in a register, the instruction selects a bit position relative to the bit base in the range -2^{63} to $+2^{63} - 1$ if the operand size is 64, -2^{31} to $+2^{31} - 1$, if the operand size is 32, and -2^{15} to $+2^{15} - 1$ if the operand size is 16. If the bit index is in an immediate value, the bit selected is that value modulo 16, 32, or 64, depending on operand size.

When the instruction attempts to copy a bit from memory, it accesses 2, 4, or 8 bytes starting from the specified memory address for 16-bit, 32-bit, or 64-bit operand sizes, respectively, using the following formula:

$$\text{Effective Address} + (\text{NumBytes}_i * (\text{BitOffset DIV NumBits}_i * 8))$$

When using this bit addressing mechanism, avoid referencing areas of memory close to address space holes, such as references to memory-mapped I/O registers. Instead, use a MOV instruction to load a register from such an address and use a register form of the BT instruction to manipulate the data.

Mnemonic	Opcode	Description
BT <i>reg/mem16, reg16</i>	0F A3 /r	Copy the value of the selected bit to the carry flag.
BT <i>reg/mem32, reg32</i>	0F A3 /r	Copy the value of the selected bit to the carry flag.
BT <i>reg/mem64, reg64</i>	0F A3 /r	Copy the value of the selected bit to the carry flag.
BT <i>reg/mem16, imm8</i>	0F BA /4 <i>ib</i>	Copy the value of the selected bit to the carry flag.
BT <i>reg/mem32, imm8</i>	0F BA /4 <i>ib</i>	Copy the value of the selected bit to the carry flag.
BT <i>reg/mem64, imm8</i>	0F BA /4 <i>ib</i>	Copy the value of the selected bit to the carry flag.

Related Instructions

BTC, BTR, BTS

rFLAGS Affected

ID	VIP	VIF	AC	VM	RF	NT	IOPL	OF	DF	IF	TF	SF	ZF	AF	PF	CF
								U				U	U	U	U	M
21	20	19	18	17	16	14	13-12	11	10	9	8	7	6	4	2	0

Note: Bits 31-22, 15, 5, 3, and 1 are reserved. A flag set to 1 or cleared to 0 is M (modified). Unaffected flags are blank. Undefined flags are U.

Exceptions

Exception	Real	Virtual 8086	Protected	Cause of Exception
Stack, #SS	X	X	X	A memory address exceeded the stack segment limit or was non-canonical.
General protection, #GP	X	X	X	A memory address exceeded a data segment limit or was non-canonical.
				A null data segment was used to reference memory.
Page fault, #PF		X	X	A page fault resulted from the execution of the instruction.
Alignment check, #AC		X	X	An unaligned memory reference was performed while alignment checking was enabled.

BTC Bit Test and Complement

Copies a bit, specified by a bit index in a register or 8-bit immediate value (second operand), from a bit string (first operand), also called the bit base, to the carry flag (CF) of the rFLAGS register, and then complements (toggles) the bit in the bit string.

If the bit base operand is a register, the instruction uses the modulo 16, 32, or 64 (depending on the operand size) of the bit index to select a bit in the register.

If the bit base operand is a memory location, bit 0 of the byte at the specified address is the bit base of the bit string. If the bit index is in a register, the instruction selects a bit position relative to the bit base in the range -2^{63} to $+2^{63} - 1$ if the operand size is 64, -2^{31} to $+2^{31} - 1$, if the operand size is 32, and -2^{15} to $+2^{15} - 1$ if the operand size is 16. If the bit index is in an immediate value, the bit selected is that value modulo 16, 32, or 64, depending the operand size.

This instruction is useful for implementing semaphores in concurrent operating systems. Such an application should precede this instruction with the LOCK prefix. For details about the LOCK prefix, see “Lock Prefix” on page 10.

Mnemonic	Opcode	Description
BTC <i>reg/mem16, reg16</i>	0F BB /r	Copy the value of the selected bit to the carry flag, then complement the selected bit.
BTC <i>reg/mem32, reg32</i>	0F BB /r	Copy the value of the selected bit to the carry flag, then complement the selected bit.
BTC <i>reg/mem64, reg64</i>	0F BB /r	Copy the value of the selected bit to the carry flag, then complement the selected bit.
BTC <i>reg/mem16, imm8</i>	0F BA /7 <i>ib</i>	Copy the value of the selected bit to the carry flag, then complement the selected bit.
BTC <i>reg/mem32, imm8</i>	0F BA /7 <i>ib</i>	Copy the value of the selected bit to the carry flag, then complement the selected bit.
BTC <i>reg/mem64, imm8</i>	0F BA /7 <i>ib</i>	Copy the value of the selected bit to the carry flag, then complement the selected bit.

Related Instructions

BT, BTR, BTS

rFLAGS Affected

ID	VIP	VIF	AC	VM	RF	NT	IOPL	OF	DF	IF	TF	SF	ZF	AF	PF	CF
								U				U	U	U	U	M
21	20	19	18	17	16	14	13-12	11	10	9	8	7	6	4	2	0

Note: Bits 31-22, 15, 5, 3, and 1 are reserved. A flag set to 1 or cleared to 0 is M (modified). Unaffected flags are blank. Undefined flags are U.

Exceptions

Exception	Real	Virtual 8086	Protected	Cause of Exception
Stack, #SS	X	X	X	A memory address exceeded the stack segment limit or was non-canonical.
General protection, #GP	X	X	X	A memory address exceeded a data segment limit or was non-canonical.
			X	The destination operand was in a non-writable segment.
			X	A null data segment was used to reference memory.
Page fault, #PF		X	X	A page fault resulted from the execution of the instruction.
Alignment check, #AC		X	X	An unaligned memory reference was performed while alignment checking was enabled.

BTR Bit Test and Reset

Copies a bit, specified by a bit index in a register or 8-bit immediate value (second operand), from a bit string (first operand), also called the bit base, to the carry flag (CF) of the rFLAGS register, and then clears the bit in the bit string to 0.

If the bit base operand is a register, the instruction uses the modulo 16, 32, or 64 (depending on the operand size) of the bit index to select a bit in the register.

If the bit base operand is a memory location, bit 0 of the byte at the specified address is the bit base of the bit string. If the bit index is in a register, the instruction selects a bit position relative to the bit base in the range -2^{63} to $+2^{63} - 1$ if the operand size is 64, -2^{31} to $+2^{31} - 1$, if the operand size is 32, and -2^{15} to $+2^{15} - 1$ if the operand size is 16. If the bit index is in an immediate value, the bit selected is that value modulo 16, 32, or 64, depending on the operand size.

This instruction is useful for implementing semaphores in concurrent operating systems. Such applications should precede this instruction with the LOCK prefix. For details about the LOCK prefix, see “Lock Prefix” on page 10.

Mnemonic	Opcode	Description
BTR <i>reg/mem16, reg16</i>	0F B3 /r	Copy the value of the selected bit to the carry flag, then clear the selected bit.
BTR <i>reg/mem32, reg32</i>	0F B3 /r	Copy the value of the selected bit to the carry flag, then clear the selected bit.
BTR <i>reg/mem64, reg64</i>	0F B3 /r	Copy the value of the selected bit to the carry flag, then clear the selected bit.
BTR <i>reg/mem16, imm8</i>	0F BA /6 <i>ib</i>	Copy the value of the selected bit to the carry flag, then clear the selected bit.
BTR <i>reg/mem32, imm8</i>	0F BA /6 <i>ib</i>	Copy the value of the selected bit to the carry flag, then clear the selected bit.
BTR <i>reg/mem64, imm8</i>	0F BA /6 <i>ib</i>	Copy the value of the selected bit to the carry flag, then clear the selected bit.

Related Instructions

BT, BTC, BTS

rFLAGS Affected

ID	VIP	VIF	AC	VM	RF	NT	IOPL	OF	DF	IF	TF	SF	ZF	AF	PF	CF
								U				U	U	U	U	M
21	20	19	18	17	16	14	13-12	11	10	9	8	7	6	4	2	0

Note: Bits 31-22, 15, 5, 3, and 1 are reserved. A flag set to 1 or cleared to 0 is M (modified). Unaffected flags are blank. Undefined flags are U.

Exceptions

Exception	Real	Virtual 8086	Protected	Cause of Exception
Stack, #SS	X	X	X	A memory address exceeded the stack segment limit or was non-canonical.
General protection, #GP	X	X	X	A memory address exceeded a data segment limit or was non-canonical.
			X	The destination operand was in a non-writable segment.
			X	A null data segment was used to reference memory.
Page fault, #PF		X	X	A page fault resulted from the execution of the instruction.
Alignment check, #AC		X	X	An unaligned memory reference was performed while alignment checking was enabled.

BTS Bit Test and Set

Copies a bit, specified by bit index in a register or 8-bit immediate value (second operand), from a bit string (first operand), also called the bit base, to the carry flag (CF) of the rFLAGS register, and then sets the bit in the bit string to 1.

If the bit base operand is a register, the instruction uses the modulo 16, 32, or 64 (depending on the operand size) of the bit index to select a bit in the register.

If the bit base operand is a memory location, bit 0 of the byte at the specified address is the bit base of the bit string. If the bit index is in a register, the instruction selects a bit position relative to the bit base in the range -2^{63} to $+2^{63} - 1$ if the operand size is 64, -2^{31} to $+2^{31} - 1$, if the operand size is 32, and -2^{15} to $+2^{15} - 1$ if the operand size is 16. If the bit index is in an immediate value, the bit selected is that value modulo 16, 32, or 64, depending on the operand size.

This instruction is useful for implementing semaphores in concurrent operating systems. Such applications should precede this instruction with the LOCK prefix. For details about the LOCK prefix, see “Lock Prefix” on page 10.

Mnemonic	Opcode	Description
BTS <i>reg/mem16, reg16</i>	0F AB /r	Copy the value of the selected bit to the carry flag, then set the selected bit.
BTS <i>reg/mem32, reg32</i>	0F AB /r	Copy the value of the selected bit to the carry flag, then set the selected bit.
BTS <i>reg/mem64, reg64</i>	0F AB /r	Copy the value of the selected bit to the carry flag, then set the selected bit.
BTS <i>reg/mem16, imm8</i>	0F BA /5 <i>ib</i>	Copy the value of the selected bit to the carry flag, then set the selected bit.
BTS <i>reg/mem32, imm8</i>	0F BA /5 <i>ib</i>	Copy the value of the selected bit to the carry flag, then set the selected bit.
BTS <i>reg/mem64, imm8</i>	0F BA /5 <i>ib</i>	Copy the value of the selected bit to the carry flag, then set the selected bit.

Related Instructions

BT, BTC, BTR

rFLAGS Affected

ID	VIP	VIF	AC	VM	RF	NT	IOPL	OF	DF	IF	TF	SF	ZF	AF	PF	CF
								U				U	U	U	U	M
21	20	19	18	17	16	14	13-12	11	10	9	8	7	6	4	2	0

Note: Bits 31-22, 15, 5, 3, and 1 are reserved. A flag set to 1 or cleared to 0 is M (modified). Unaffected flags are blank. Undefined flags are U.

Exceptions

Exception	Real	Virtual 8086	Protected	Cause of Exception
Stack, #SS	X	X	X	A memory address exceeded the stack segment limit or was non-canonical.
General protection, #GP	X	X	X	A memory address exceeded a data segment limit or was non-canonical.
			X	The destination operand was in a non-writable segment.
			X	A null data segment was used to reference memory.
Page fault, #PF		X	X	A page fault resulted from the execution of the instruction.
Alignment check, #AC		X	X	An unaligned memory reference was performed while alignment checking was enabled.

CALL (Near) Near Procedure Call

Pushes the offset of the next instruction onto the stack and branches to the target address, which contains the first instruction of the called procedure. The target operand can specify a register, a memory location, or a label. A procedure accessed by a near CALL is located in the same code segment as the CALL instruction.

If the CALL target is specified by a register or memory location, then a 16-, 32-, or 64-bit rIP is read from the operand, depending on the operand size. A 16- or 32-bit rIP is zero-extended to 64 bits.

If the CALL target is specified by a displacement, the signed displacement is added to the rIP (of the following instruction), and the result is truncated to 16, 32, or 64 bits, depending on the operand size. The signed displacement is 16 or 32 bits, depending on the operand size.

In all cases, the rIP of the instruction after the CALL is pushed on the stack, and the size of the stack push (16, 32, or 64 bits) depends on the operand size of the CALL instruction.

For near calls in 64-bit mode, the operand size defaults to 64 bits. The E8 opcode results in $RIP = RIP + 32\text{-bit signed displacement}$ and the FF /2 opcode results in $RIP = 64\text{-bit offset from register or memory}$. No prefix is available to encode a 32-bit operand size in 64-bit mode.

At the end of the called procedure, RET is used to return control to the instruction following the original CALL. When RET is executed, the rIP is popped off the stack, which returns control to the instruction after the CALL.

See CALL (Far) for information on far calls—calls to procedures located outside of the current code segment. For details about control-flow instructions, see “Control Transfers” in Volume 1, and “Control-Transfer Privilege Checks” in Volume 2.

Mnemonic	Opcode	Description
CALL <i>rel16off</i>	E8 <i>iw</i>	Near call with the target specified by a 16-bit relative displacement.
CALL <i>rel32off</i>	E8 <i>id</i>	Near call with the target specified by a 32-bit relative displacement.
CALL <i>reg/mem16</i>	FF /2	Near call with the target specified by <i>reg/mem16</i> .

Mnemonic	Opcode	Description
CALL <i>reg/mem32</i>	FF /2	Near call with the target specified by <i>reg/mem32</i> . (There is no prefix for encoding this in 64-bit mode.)
CALL <i>reg/mem64</i>	FF /2	Near call with the target specified by <i>reg/mem64</i> .

For details about control-flow instructions, see “Control Transfers” in Volume 1, and “Control-Transfer Privilege Checks” in Volume 2.

Related Instructions

CALL(Far), RET(Near), RET(Far)

rFLAGS Affected

None.

Exceptions

Exception	Real	Virtual 8086	Protected	Cause of Exception
Stack, #SS	X	X	X	A memory address exceeded the stack segment limit or was non-canonical.
General protection, #GP	X	X	X	A memory address exceeded a data segment limit or was non-canonical.
	X	X	X	The target offset exceeded the code segment limit or was non-canonical.
			X	A null data segment was used to reference memory.
Alignment Check, #AC		X	X	An unaligned memory reference was performed while alignment checking was enabled.
Page Fault, #PF		X	X	A page fault resulted from the execution of the instruction.

CALL (Far) Far Procedure Call

Pushes procedure linking information onto the stack and branches to the target address, which contains the first instruction of the called procedure. The operand specifies a target selector and offset.

The instruction can specify the target directly, by including the far pointer in the CALL (Far) opcode itself, or indirectly, by referencing a far pointer in memory. In 64-bit mode, only indirect far calls are allowed, executing a direct far call (opcode 9A) generates an undefined opcode exception.

The target selector used by the instruction can be a code selector in all modes. Additionally, the target selector can reference a call gate in protected mode, or a task gate or TSS selector in legacy protected mode.

- *Target is a code selector*—The CS:rIP of the next instruction is pushed to the stack, using operand-size stack pushes. Then code is executed from the target CS:rIP. In this case, the target offset can only be a 16- or 32-bit value, depending on operand-size, and is zero-extended to 64 bits. No CPL change is allowed.
- *Target is a call gate*—The call gate specifies the actual target code segment and offset. Call gates allow calls to the same or more privileged code. If the target segment is at the same CPL as the current code segment, the CS:rIP of the next instruction is pushed to the stack.

If the CALL (Far) changes privilege level, then a stack-switch occurs, using an inner-level stack pointer from the TSS. The CS:rIP of the next instruction is pushed to the new stack. If the mode is legacy mode and the param-count field in the call gate is non-zero, then up to 31 operands are copied from the caller's stack to the new stack. Finally, the caller's SS:rSP is pushed to the new stack.

When calling through a call gate, the stack pushes are 16-, 32-, or 64-bits, depending on the size of the call gate. The size of the target rIP is also 16, 32, or 64 bits, depending on the size of the call gate. If the target rIP is less than 64 bits, it is zero-extended to 64 bits. Long mode only allows 64-bit call gates that must point to 64-bit code segments.

- *Target is a task gate or a TSS*—If the mode is legacy protected mode, then a task switch occurs. See “Hardware Task-Management in Legacy Mode” in volume 2 for details about task switches. Hardware task switches are not supported in long mode.

See CALL (Near) for information on near calls—calls to procedures located inside the current code segment. For details about control-flow instructions, see “Control Transfers” in Volume 1, and “Control-Transfer Privilege Checks” in Volume 2.

Mnemonic	Opcode	Description
CALL FAR <i>ptr16:16</i>	9A <i>cd</i>	Far call direct, with the target specified by a far pointer contained in the instruction. (Invalid in 64-bit mode.)
CALL FAR <i>ptr16:32</i>	9A <i>cp</i>	Far call direct, with the target specified by a far pointer contained in the instruction. (Invalid in 64-bit mode.)
CALL FAR <i>mem16:16</i>	FF /3	Far call indirect, with the target specified by a far pointer in memory.
CALL FAR <i>mem16:32</i>	FF /3	Far call indirect, with the target specified by a far pointer in memory.

Action

// See “Pseudocode Definitions” on page 49.

CALLF_START:

```
IF (REAL_MODE)
    CALLF_REAL_OR_VIRTUAL
ELIF (PROTECTED_MODE)
    CALLF_PROTECTED
ELSE // (VIRTUAL_MODE)
    CALLF_REAL_OR_VIRTUAL
```

CALLF_REAL_OR_VIRTUAL:

```
IF (OPCODE = callf [mem]) // CALLF Indirect
{
    temp_RIP = READ_MEM.z [mem]
    temp_CS = READ_MEM.w [mem+Z]
}
ELSE // (OPCODE = callf direct)
{
    temp_RIP = z-sized offset specified in the instruction
                zero-extended to 64 bits
    temp_CS = selector specified in the instruction
}

PUSH.v old_CS
PUSH.v next_RIP

IF (temp_RIP > CS.limit)
    EXCEPTION [#GP(0)]

CS.sel = temp_CS
CS.base = temp_CS SHL 4
RIP = temp_RIP
EXIT
```

CALLF_PROTECTED:

```

IF (OPCODE = callf [mem])      //CALLF Indirect
{
    temp_offset = READ_MEM.z [mem]
    temp_sel    = READ_MEM.w [mem+Z]
}
ELSE // (OPCODE = callf direct)
{
    IF (64BIT_MODE)
        EXCEPTION [#UD]          // 'CALLF direct' is illegal in 64-bit mode.
    temp_offset = z-sized offset specified in the instruction
                  zero-extended to 64 bits
    temp_sel    = selector specified in the instruction
}

temp_desc = READ_DESCRIPTOR (temp_sel, cs_chk)

IF (temp_desc.attr.type = 'available_tss')
    TASK_SWITCH    // Using temp_sel as the target TSS selector.
ELIF (temp_desc.attr.type = 'taskgate')
    TASK_SWITCH    // Using the TSS selector in the task gate
                  // as the target TSS.
ELIF (temp_desc.attr.type = 'code')
    // If the selector refers to a code descriptor, then
    // the offset we read is the target RIP.
{
    temp_RIP = temp_offset
    CS = temp_desc
    PUSH.v old_CS
    PUSH.v next_RIP
    IF ((!64BIT_MODE) && (temp_RIP > CS.limit))
        EXCEPTION [#GP(0)]      // temp_RIP can't be non-canonical because
                                // it's a 16- or 32-bit offset, zero-extended
                                // to 64 bits.

    RIP = temp_RIP
    EXIT
}
ELSE // (temp_desc.attr.type = 'callgate')
    // If the selector refers to a call gate, then
    // the target CS and RIP both come from the call gate.
{
    IF (LONG_MODE)
        // The size of the gate controls the size of the stack pushes.
        V=8-byte
        // Long mode only uses 64-bit call gates, force 8-byte opsize.
    ELIF (temp_desc.attr.type = 'callgate32')
        V=4-byte
        // Legacy mode, using a 32-bit call-gate, force 4-byte opsize.
}

```

```

ELSE // (temp_desc.attr.type = 'callgate16')
    V=2-byte // Legacy mode, using a 16-bit call-gate, force 2-byte opsize.

temp_RIP = temp_desc.offset

IF (LONG_MODE) // In long mode, we need to read the 2nd half of a
                // 16-byte call-gate from the GDT/LDT, to get the upper
                // 32 bits of the target RIP.
{
    temp_upper = READ_MEM.q [temp_sel+8]
    IF (temp_upper's extended attribute bits != 0)
        EXCEPTION [#GP(temp_sel)]
    temp_RIP = temp_RIP + (temp_upper SHL 32)
                // Concatenate both halves of RIP
}

CS = READ_DESCRIPTOR (temp_desc.segment, clg_chk)

IF (CS.attr.conforming=1)
    temp_CPL = CPL
ELSE
    temp_CPL = CS.attr.dpl

IF (CPL=temp_CPL)
{
    PUSH.v old_CS
    PUSH.v next_RIP

    IF ((64BIT_MODE) && (temp_RIP is non-canonical)
        || (!64BIT_MODE) && (temp_RIP > CS.limit))
    {
        EXCEPTION[#GP(0)]
    }

    RIP = temp_RIP
    EXIT
}
ELSE // (CPL != temp_CPL), Changing privilege level.
{
    CPL = temp_CPL
    temp_ist = 0 // Call-far doesn't use ist pointers.
    temp_SS_desc:temp_RSP = READ_INNER_LEVEL_STACK_POINTER (CPL, temp_ist)

    RSP.q = temp_RSP
    SS = temp_SS_desc
    PUSH.v old_SS // #SS on this and following pushes use
                  // SS.sel as error code.

    PUSH.v old_RSP
    IF (LEGACY_MODE) // Legacy-mode call gates have
                    // a param_count field.
{

```

```

        temp_PARAM_COUNT = temp_desc.attr.param_count

        FOR (I=temp_PARAM_COUNT; I>0; I--)
        {
            temp_DATA = READ_MEM.v [old_SS:(old_RSP+I*V)]
            PUSH.v temp_DATA
        }
    }
    PUSH.v old_CS
    PUSH.v next_RIP
    IF ((64BIT_MODE) && (temp_RIP is non-canonical)
        || (!64BIT_MODE) && (temp_RIP > CS.limit))
    {
        EXCEPTION [#GP(0)]
    }
    RIP = temp_RIP
    EXIT
}
}

```

Related Instructions

CALL (Near), RET (Near), RET (Far)

rFLAGS Affected

None, unless a task switch occurs, in which case all flags are modified.

Exceptions

Exception	Real	Virtual 8086	Protected	Cause of Exception
Invalid opcode, #UD	X	X	X	The far CALL indirect opcode (FF /3) had a register operand.
			X	The far CALL direct opcode (9A) was executed in 64-bit mode.
Invalid TSS, #TS (selector)			X	As part of a stack switch, the target stack segment selector or rSP in the TSS was beyond the TSS limit.
			X	As part of a stack switch, the target stack segment selector in the TSS was a null selector.
			X	As part of a stack switch, the target stack selector's TI bit was set, but LDT selector was a null selector.
			X	As part of a stack switch, the target stack segment selector in the TSS was beyond the limit of the GDT or LDT descriptor table.
			X	As part of a stack switch, the target stack segment selector in the TSS contained a RPL that was not equal to its DPL.
			X	As part of a stack switch, the target stack segment selector in the TSS contained a DPL that was not equal to the CPL of the code segment selector.
Segment not present, #NP (selector)			X	The accessed code segment, call gate, task gate, or TSS was not present.
			X	As part of a stack switch, the target stack segment selector in the TSS was not a writable segment.
Stack, #SS	X	X	X	A memory address exceeded the stack segment limit or was non-canonical, and no stack switch occurred.
Stack, #SS (selector)			X	After a stack switch, a memory access exceeded the stack segment limit or was non-canonical.
			X	As part of a stack switch, the SS register was loaded with a non-null segment selector and the segment was marked not present.
General protection, #GP	X	X	X	A memory address exceeded a data segment limit or was non-canonical.
			X	The target offset exceeded the code segment limit or was non-canonical.
			X	A null data segment was used to reference memory.

Exception	Real	Virtual 8086	Protected	Cause of Exception
General protection, #GP (selector)			X	The target code segment selector was a null selector.
			X	A code, call gate, task gate, or TSS descriptor exceeded the descriptor table limit.
			X	A segment selector's TI bit was set but the LDT selector was a null selector.
			X	The segment descriptor specified by the instruction was not a code segment, task gate, call gate or available TSS in legacy mode, or not a 64-bit code segment or a 64-bit call gate in long mode.
			X	The RPL of the non-conforming code segment selector specified by the instruction was greater than the CPL, or its DPL was not equal to the CPL.
			X	The DPL of the conforming code segment descriptor specified by the instruction was greater than the CPL.
			X	The DPL of the callgate, taskgate, or TSS descriptor specified by the instruction was less than the CPL, or less than its own RPL.
			X	The segment selector specified by the call gate or task gate was a null selector.
			X	The segment descriptor specified by the call gate was not a code segment in legacy mode, or not a 64-bit code segment in long mode.
			X	The DPL of the segment descriptor specified by the call gate was greater than the CPL.
			X	The 64-bit call gate's extended attribute bits were not zero.
			X	The TSS descriptor was found in the LDT.
Page fault, #PF		X	X	A page fault resulted from the execution of the instruction.
Alignment check, #AC		X	X	An unaligned memory reference was performed while alignment checking was enabled.

CBW Convert to Sign-extended

CWDE

CDQE

Copies the sign bit in the AL or eAX register to the upper bits of the rAX register. The effect of this instruction is to convert a signed byte, word, or doubleword in the AL or eAX register into a signed word, doubleword, or double quadword in the rAX register. This action helps avoid overflow problems in signed number arithmetic.

The CDQE mnemonic is meaningful only in 64-bit mode.

Mnemonic	Opcode	Description
CBW	98	Sign-extend AL into AX.
CWDE	98	Sign-extend AX into EAX.
CDQE	98	Sign-extend EAX into RAX.

Related Instructions

CWD, CDQ, CQO

rFLAGS Affected

None

Exceptions

None

CWD

Convert to Sign-extended

CDQ

CQO

Copies the sign bit in the rAX register to all bits of the rDX register. The effect of this instruction is to convert a signed word, doubleword, or quadword in the rAX register into a signed doubleword, quadword, or double-quadword in the rDX:rAX registers. This action helps avoid overflow problems in signed number arithmetic.

The CQO mnemonic is meaningful only in 64-bit mode.

Mnemonic	Opcode	Description
CWD	99	Sign-extend AX into DX:AX.
CDQ	99	Sign-extend EAX into EDX:EAX.
CQO	99	Sign-extend RAX into RDX:RAX.

Related Instructions

CBW, CWDE, CDQE

rFLAGS Affected

None

Exceptions

None

CLC Clear Carry Flag

Clears the carry flag (CF) in the rFLAGS register to zero.

Mnemonic	Opcode	Description
CLC	F8	Clear the carry flag (CF) to zero.

Related Instructions

STC, CMC

rFLAGS Affected

ID	VIP	VIF	AC	VM	RF	NT	IOPL	OF	DF	IF	TF	SF	ZF	AF	PF	CF
																0
21	20	19	18	17	16	14	13–12	11	10	9	8	7	6	4	2	0
<i>Note: Bits 31–22, 15, 5, 3, and 1 are reserved. A flag set to 1 or cleared to 0 is M (modified). Unaffected flags are blank. Undefined flags are U.</i>																

Exceptions

None

CLD Clear Direction Flag

Clears the direction flag (DF) in the rFLAGS register to zero. If the DF flag is 0, each iteration of a string instruction increments the data pointer (index registers rSI or rDI). If the DF flag is 1, the string instruction decrements the pointer. Use the CLD instruction before a string instruction to make the data pointer increment.

Mnemonic	Opcode	Description
CLD	FC	Clear the direction flag (DF) to zero.

Related Instructions

CMPSx, INSx, LODSx, MOVSx, OUTSx, SCASx, STD, STOSx

rFLAGS Affected

ID	VIP	VIF	AC	VM	RF	NT	IOPL	OF	DF	IF	TF	SF	ZF	AF	PF	CF
									0							
21	20	19	18	17	16	14	13–12	11	10	9	8	7	6	4	2	0
<i>Note: Bits 31–22, 15, 5, 3, and 1 are reserved. A flag set to 1 or cleared to 0 is M (modified). Unaffected flags are blank. Undefined flags are U.</i>																

Exceptions

None

CLFLUSH Cache Line Invalidate

Invalidates the cache line specified by the *mem8* linear-address. The instruction checks all levels of the cache hierarchy—internal caches and external caches—and invalidates the cache line in every cache in which it is found. If a cache contains a dirty copy of the cache line (that is, the cache line is in the *modified* or *owned* MOESI state), the line is written back to memory before it is invalidated. The instruction sets the cache-line MOESI state to *invalid*.

The instruction also checks the physical address corresponding to the linear-address operand against the processor's write-combining buffers. If the write-combining buffer holds data intended for that physical address, the instruction writes the entire contents of the buffer to memory. This occurs even though the data is not cached in the cache hierarchy. In a multiprocessor system, the instruction checks the write-combining buffers only on the processor that executed the CLFLUSH instruction.

The CLFLUSH instruction is weakly-ordered with respect to other instructions that operate on memory. Speculative loads initiated by the processor, or specified explicitly using cache-prefetch instructions, can be reordered around a CLFLUSH instruction. Such reordering can cause freshly-loaded cache lines to be flushed unintentionally. The only way to avoid this situation is to use the MFENCE instruction to force strong-ordering of the CLFLUSH instruction with respect to other memory operations. The LFENCE, SFENCE, and serializing instructions are *not* ordered with respect to CLFLUSH.

The CLFLUSH instruction behaves like a load instruction with respect to setting the page-table accessed and dirty bits. That is, it sets the page-table accessed bit to 1, but does not set the page-table dirty bit.

The CLFLUSH instruction is supported if CUID standard function 1 bit 19 is set. CUID function 1 returns the CLFLUSH size in EBX bits 23:16. This value reports the size of a line flushed by CLFLUSH in quadwords. See CUID for details.

The CLFLUSH instruction executes at any privilege level. CLFLUSH performs all the segmentation and paging checks that a 1-byte read would perform, except that it also allows references to execute-only segments.

Mnemonic	Opcode	Description
CLFLUSH <i>mem8</i>	OF AE /7	flush cache line containing <i>mem8</i> .

Related Instructions

INVD, WBINVD

rFLAGS Affected

None

Exceptions

Exception (vector)	Real	Virtual 8086	Protected	Cause of Exception
Invalid opcode, #UD	X	X	X	The CLFLUSH instruction is not supported, as indicated by bit 19 of CPUID standard function 1.
Stack, #SS	X	X	X	A memory address exceeded the stack segment limit or was non-canonical.
General protection, #GP	X	X	X	A memory address exceeded a data segment limit or was non-canonical.
				A null data segment was used to reference memory.
Page fault, #PF		X	X	A page fault resulted from the execution of the instruction.

CMC Complement Carry Flag

Complements (toggles) the carry flag (CF) bit of the rFLAGS register.

Mnemonic	Opcode	Description
CMC	F5	Complement the carry flag (CF).

Related Instructions

CLC, STC

rFLAGS Affected

ID	VIP	VIF	AC	VM	RF	NT	IOPL	OF	DF	IF	TF	SF	ZF	AF	PF	CF
																M
21	20	19	18	17	16	14	13–12	11	10	9	8	7	6	4	2	0
<i>Note: Bits 31–22, 15, 5, 3, and 1 are reserved. A flag set to 1 or cleared to 0 is M (modified). Unaffected flags are blank. Undefined flags are U.</i>																

Exceptions

None

CMOVcc Conditional Move

Conditionally moves a 16-bit, 32-bit, or 64-bit value in memory or a general-purpose register (second operand) into a register (first operand), depending upon the settings of condition flags in the rFLAGS register. If the condition is not satisfied, the instruction has no effect.

The mnemonics of CMOVcc instructions denote the condition that must be satisfied. Most assemblers provide instruction mnemonics with A (above) and B (below) tags to supply the semantics for manipulating unsigned integers. Those with G (greater than) and L (less than) tags deal with signed integers. Many opcodes may be represented by synonymous mnemonics. For example, the CMOVL instruction is synonymous with the CMOVNGE instruction and denote the instruction with the opcode 0F 4C.

Support for CMOVcc instructions depends on the processor implementation. To determine whether a processor can perform CMOVcc instructions, use the CPUID instruction to determine whether bit 15 of CPUID standard function 1 or extended function 8000_0001h is set to 1.

Mnemonic	Opcode	Description
CMOVO <i>reg16, reg/mem16</i> CMOVO <i>reg32, reg/mem32</i> CMOVO <i>reg64, reg/mem64</i>	0F 40 /r	Move if overflow (OF = 1).
CMOVNO <i>reg16, reg/mem16</i> CMOVNO <i>reg32, reg/mem32</i> CMOVNO <i>reg64, reg/mem64</i>	0F 41 /r	Move if not overflow (OF = 0).
CMOVB <i>reg16, reg/mem16</i> CMOVB <i>reg32, reg/mem32</i> CMOVB <i>reg64, reg/mem64</i>	0F 42 /r	Move if below (CF = 1).
CMOVC <i>reg16, reg/mem16</i> CMOVC <i>reg32, reg/mem32</i> CMOVC <i>reg64, reg/mem64</i>	0F 42 /r	Move if carry (CF = 1).
CMOVNAE <i>reg16, reg/mem16</i> CMOVNAE <i>reg32, reg/mem32</i> CMOVNAE <i>reg64, reg/mem64</i>	0F 42 /r	Move if not above or equal (CF = 1).
CMOVNB <i>reg16, reg/mem16</i> CMOVNB <i>reg32, reg/mem32</i> CMOVNB <i>reg64, reg/mem64</i>	0F 43 /r	Move if not below (CF = 0).

Mnemonic	Opcode	Description
CMOVNC <i>reg16,reg/mem16</i> CMOVNC <i>reg32,reg/mem32</i> CMOVNC <i>reg64,reg/mem64</i>	0F 43 /r	Move if not carry (CF = 0).
CMOVAE <i>reg16, reg/mem16</i> CMOVAE <i>reg32, reg/mem32</i> CMOVAE <i>reg64, reg/mem64</i>	0F 43 /r	Move if above or equal (CF = 0).
CMOVZ <i>reg16, reg/mem16</i> CMOVZ <i>reg32, reg/mem32</i> CMOVZ <i>reg64, reg/mem64</i>	0F 44 /r	Move if zero (ZF = 1).
CMOVE <i>reg16, reg/mem16</i> CMOVE <i>reg32, reg/mem32</i> CMOVE <i>reg64, reg/mem64</i>	0F 44 /r	Move if equal (ZF = 1).
CMOVNZ <i>reg16, reg/mem16</i> CMOVNZ <i>reg32, reg/mem32</i> CMOVNZ <i>reg64, reg/mem64</i>	0F 45 /r	Move if not zero (ZF = 0).
CMOVNE <i>reg16, reg/mem16</i> CMOVNE <i>reg32, reg/mem32</i> CMOVNE <i>reg64, reg/mem64</i>	0F 45 /r	Move if not equal (ZF = 0).
CMOVBE <i>reg16, reg/mem16</i> CMOVBE <i>reg32, reg/mem32</i> CMOVBE <i>reg64, reg/mem64</i>	0F 46 /r	Move if below or equal (CF = 1 or ZF = 1).
CMOVNA <i>reg16, reg/mem16</i> CMOVNA <i>reg32, reg/mem32</i> CMOVNA <i>reg64, reg/mem64</i>	0F 46 /r	Move if not above (CF = 1 or ZF = 1).
CMOVNBE <i>reg 16, reg/mem16</i> CMOVNBE <i>reg32,reg/mem32</i> CMOVNBE <i>reg64,reg/mem64</i>	0F 47 /r	Move if not below or equal (CF = 0 and ZF = 0).
CMOVA <i>reg16, reg/mem16</i> CMOVA <i>reg32, reg/mem32</i> CMOVA <i>reg64, reg/mem64</i>	0F 47 /r	Move if above (CF = 1 and ZF = 0).
CMOVS <i>reg16, reg/mem16</i> CMOVS <i>reg32, reg/mem32</i> CMOVS <i>reg64, reg/mem64</i>	0F 48 /r	Move if sign (SF = 1).
CMOVNS <i>reg16, reg/mem16</i> CMOVNS <i>reg32, reg/mem32</i> CMOVNS <i>reg64, reg/mem64</i>	0F 49 /r	Move if not sign (SF = 0).
CMOVP <i>reg16, reg/mem16</i> CMOVP <i>reg32, reg/mem32</i> CMOVP <i>reg64, reg/mem64</i>	0F 4A /r	Move if parity (PF = 1).

Mnemonic	Opcode	Description
CMOVPE <i>reg16, reg/mem16</i> CMOVPE <i>reg32, reg/mem32</i> CMOVPE <i>reg64, reg/mem64</i>	0F 4A /r	Move if parity even (PF = 1).
CMOVNP <i>reg16, reg/mem16</i> CMOVNP <i>reg32, reg/mem32</i> CMOVNP <i>reg64, reg/mem64</i>	0F 4B /r	Move if not parity (PF = 0).
CMOVPO <i>reg16, reg/mem16</i> CMOVPO <i>reg32, reg/mem32</i> CMOVPO <i>reg64, reg/mem64</i>	0F 4B /r	Move if parity odd (PF = 0).
CMOVL <i>reg16, reg/mem16</i> CMOVL <i>reg32, reg/mem32</i> CMOVL <i>reg64, reg/mem64</i>	0F 4C /r	Move if less (SF \diamond OF).
CMOVNGE <i>reg16, reg/mem16</i> CMOVNGE <i>reg32, reg/mem32</i> CMOVNGE <i>reg64, reg/mem64</i>	0F 4C /r	Move if not greater or equal (SF \diamond OF).
CMOVNL <i>reg16, reg/mem16</i> CMOVNL <i>reg32, reg/mem32</i> CMOVNL <i>reg64, reg/mem64</i>	0F 4D /r	Move if not less (SF = OF).
CMOVGE <i>reg16, reg/mem16</i> CMOVGE <i>reg32, reg/mem32</i> CMOVGE <i>reg64, reg/mem64</i>	0F 4D /r	Move if greater or equal (SF = OF).
CMOVLE <i>reg16, reg/mem16</i> CMOVLE <i>reg32, reg/mem32</i> CMOVLE <i>reg64, reg/mem64</i>	0F 4E /r	Move if less or equal (ZF = 1 or SF \diamond OF).
CMOVNG <i>reg16, reg/mem16</i> CMOVNG <i>reg32, reg/mem32</i> CMOVNG <i>reg64, reg/mem64</i>	0F 4E /r	Move if not greater (ZF = 1 or SF \diamond OF).
CMOVNLE <i>reg16, reg/mem16</i> CMOVNLE <i>reg32, reg/mem32</i> CMOVNLE <i>reg64, reg/mem64</i>	0F 4F /r	Move if not less or equal (ZF = 0 and SF = OF).
CMOVG <i>reg16, reg/mem16</i> CMOVG <i>reg32, reg/mem32</i> CMOVG <i>reg64, reg/mem64</i>	0F 4F /r	Move if greater (ZF = 0 and SF = OF).

Related Instructions

MOV

rFLAGS Affected

None

Exceptions

Exception	Real	Virtual 8086	Protected	Cause of Exception
Invalid opcode, #UD	X	X	X	The CMOVcc instruction is not supported, as indicated by bit 15 of CPUID standard function 1 or extended function 8000_0001h.
Stack, #SS	X	X	X	A memory address exceeded the stack segment limit or was non-canonical.
General protection, #GP	X	X	X	A memory address exceeded a data segment limit or was non-canonical.
			X	A null data segment was used to reference memory.
Page fault, #PF		X	X	A page fault resulted from the execution of the instruction.
Alignment check, #AC		X	X	An unaligned memory reference was performed while alignment checking was enabled.

CMP Compare

Compares the contents of a register or memory location (first operand) with an immediate value or the contents of a register or memory location (second operand), and sets or clears the status flags in the rFLAGS register to reflect the results. To perform the comparison, the instruction subtracts the second operand from the first operand and sets the status flags in the same manner as the SUB instruction, but does not alter the first operand. If the second operand is an immediate value, the instruction sign-extends the value to the length of the first operand.

Use the CMP instruction to set the condition codes for a subsequent conditional jump (Jcc), conditional move (CMOVcc), or conditional SETcc instruction. Appendix E, “Instruction Effects on RFLAGS,” shows how instructions affect the rFLAGS status flags.

Mnemonic	Opcode	Description
CMP AL, <i>imm8</i>	3C <i>ib</i>	Compare an 8-bit immediate value with the contents of the AL register.
CMP AX, <i>imm16</i>	3D <i>iw</i>	Compare a 16-bit immediate value with the contents of the AX register.
CMP EAX, <i>imm32</i>	3D <i>id</i>	Compare a 32-bit immediate value with the contents of the EAX register.
CMP RAX, <i>imm32</i>	3D <i>id</i>	Compare a 32-bit immediate value with the contents of the RAX register.
CMP <i>reg/mem8, imm8</i>	80 /7 <i>ib</i>	Compare an 8-bit immediate value with the contents of an 8-bit register or memory operand.
CMP <i>reg/mem16, imm16</i>	81 /7 <i>iw</i>	Compare a 16-bit immediate value with the contents of a 16-bit register or memory operand.
CMP <i>reg/mem32, imm32</i>	81 /7 <i>id</i>	Compare a 32-bit immediate value with the contents of a 32-bit register or memory operand.
CMP <i>reg/mem64, imm32</i>	81 /7 <i>id</i>	Compare a 32-bit signed immediate value with the contents of a 64-bit register or memory operand.
CMP <i>reg/mem16, imm8</i>	83 /7 <i>ib</i>	Compare an 8-bit signed immediate value with the contents of a 16-bit register or memory operand.
CMP <i>reg/mem32, imm8</i>	83 /7 <i>ib</i>	Compare an 8-bit signed immediate value with the contents of a 32-bit register or memory operand.

Mnemonic	Opcode	Description
<i>CMP reg/mem64, imm8</i>	<i>83 /7 ib</i>	Compare an 8-bit signed immediate value with the contents of a 64-bit register or memory operand.
<i>CMP reg/mem8, reg8</i>	<i>38 /r</i>	Compare the contents of an 8-bit register or memory operand with the contents of an 8-bit register.
<i>CMP reg/mem16, reg16</i>	<i>39 /r</i>	Compare the contents of a 16-bit register or memory operand with the contents of a 16-bit register.
<i>CMP reg/mem32, reg32</i>	<i>39 /r</i>	Compare the contents of a 32-bit register or memory operand with the contents of a 32-bit register.
<i>CMP reg/mem64, reg64</i>	<i>39 /r</i>	Compare the contents of a 64-bit register or memory operand with the contents of a 64-bit register.
<i>CMP reg8, reg/mem8</i>	<i>3A /r</i>	Compare the contents of an 8-bit register with the contents of an 8-bit register or memory operand.
<i>CMP reg16, reg/mem16</i>	<i>3B /r</i>	Compare the contents of a 16-bit register with the contents of a 16-bit register or memory operand.
<i>CMP reg32, reg/mem32</i>	<i>3B /r</i>	Compare the contents of a 32-bit register with the contents of a 32-bit register or memory operand.
<i>CMP reg64, reg/mem64</i>	<i>3B /r</i>	Compare the contents of a 64-bit register with the contents of a 64-bit register or memory operand.

When interpreting operands as unsigned, flag settings are as follows:

Operands	CF	ZF
<i>dest > source</i>	0	0
<i>dest = source</i>	0	1
<i>dest < source</i>	1	0

When interpreting operands as signed, flag settings are as follows:

Operands	OF	ZF
<i>dest > source</i>	SF	0
<i>dest = source</i>	0	1
<i>dest < source</i>	NOT SF	0

Related InstructionsSUB, CMPS_x, SCAS_x**rFLAGS Affected**

ID	VIP	VIF	AC	VM	RF	NT	IOPL	OF	DF	IF	TF	SF	ZF	AF	PF	CF
								M				M	M	M	M	M
21	20	19	18	17	16	14	13–12	11	10	9	8	7	6	4	2	0

Note: Bits 31–22, 15, 5, 3, and 1 are reserved. A flag set to 1 or cleared to 0 is M (modified). Unaffected flags are blank. Undefined flags are U.

Exceptions

Exception	Real	Virtual 8086	Protected	Cause of Exception
Stack, #SS	X	X	X	A memory address exceeded the stack segment limit or was non-canonical.
General protection, #GP	X	X	X	A memory address exceeded a data segment limit or was non-canonical.
			X	A null data segment was used to reference memory.
Page fault, #PF		X	X	A page fault resulted from the execution of the instruction.
Alignment check, #AC		X	X	An unaligned memory reference was performed while alignment checking was enabled.

CMPS **Compare Strings**

CMPSB

CMPSW

CMPSD

CMPSQ

Compares the bytes, words, doublewords, or quadwords pointed to by the rSI and rDI registers, sets or clears the status flags of the rFLAGS register to reflect the results, and then increments or decrements the rSI and rDI registers according to the state of the DF flag in the rFLAGS register. To perform the comparison, the instruction subtracts the second operand from the first operand and sets the status flags in the same manner as the SUB instruction, but does not alter the first operand. The two operands must be the same size.

If the DF flag is 0, the instruction increments rSI and rDI; otherwise, it decrements the pointers. It increments or decrements the pointers by 1, 2, 4, or 8, depending on the size of the operands.

The forms of the CMPSx instruction with explicit operands address the first operand at *seg*:[rSI]. The value of *seg* defaults to the DS segment, but may be overridden by a segment prefix. These instructions always address the second operand at ES:[rDI]. ES may not be overridden. The explicit operands serve only to specify the type (size) of the values being compared and the segment used by the first operand.

The no-operands forms of the instruction use the DS:[rSI] and ES:[rDI] registers to point to the values to be compared. The mnemonic determines the size of the operands.

Do not confuse this CMPSD instruction with the same-mnemonic CMPSD (compare scalar double-precision floating-point) instruction in the 128-bit media instruction set. Assemblers can distinguish the instructions by the number and type of operands.

For block comparisons, the CMPS instruction supports the REPE or REPZ prefixes (they are synonyms) and the REPNE or REPNZ prefixes (they are synonyms). For details about the REP prefixes, see “Repeat Prefixes” on page 10. If a conditional jump instruction like JL follows a CMPSx instruction, the jump occurs if the value of the *seg*:[rSI] operand is less than the ES:[rDI] operand. This action allows lexicographical comparisons of string or array elements. A CMPSx instruction can also operate inside a loop controlled by the LOOPcc instruction.

Mnemonic	Opcode	Description
CMPS <i>mem8, mem8</i>	A6	Compare the byte at DS:rSI with the byte at ES:rDI and then increment or decrement rSI and rDI.
CMPS <i>mem16, mem16</i>	A7	Compare the word at DS:rSI with the word at ES:rDI and then increment or decrement rSI and rDI.
CMPS <i>mem32, mem32</i>	A7	Compare the doubleword at DS:rSI with the doubleword at ES:rDI and then increment or decrement rSI and rDI.
CMPS <i>mem64, mem64</i>	A7	Compare the quadword at DS:rSI with the quadword at ES:rDI and then increment or decrement rSI and rDI.
CMPSB	A6	Compare the byte at DS:rSI with the byte at ES:rDI and then increment or decrement rSI and rDI.
CMPSW	A7	Compare the word at DS:rSI with the word at ES:rDI and then increment or decrement rSI and rDI.
CMPSD	A7	Compare the doubleword at DS:rSI with the doubleword at ES:rDI and then increment or decrement rSI and rDI.
CMPSQ	A7	Compare the quadword at DS:rSI with the quadword at ES:rDI and then increment or decrement rSI and rDI.

Related Instructions

CMP, SCAS_x

rFLAGS Affected

ID	VIP	VIF	AC	VM	RF	NT	IOPL	OF	DF	IF	TF	SF	ZF	AF	PF	CF
								M				M	M	M	M	M
21	20	19	18	17	16	14	13–12	11	10	9	8	7	6	4	2	0
<i>Note: Bits 31–22, 15, 5, 3, and 1 are reserved. A flag set to 1 or cleared to 0 is M (modified). Unaffected flags are blank. Undefined flags are U.</i>																

Exceptions

Exception	Real	Virtual 8086	Protected	Cause of Exception
Stack, #SS	X	X	X	A memory address exceeded the stack segment limit or was non-canonical.
General protection, #GP	X	X	X	A memory address exceeded a data segment limit or was non-canonical.
			X	A null data segment was used to reference memory.
Page fault, #PF		X	X	A page fault resulted from the execution of the instruction.
Alignment check, #AC		X	X	An unaligned memory reference was performed while alignment checking was enabled.

CMPXCHG Compare and Exchange

Compares the value in the AL, AX, EAX, or RAX register with the value in a register or a memory location (first operand). If the two values are equal, the instruction copies the value in the second operand to the first operand and sets the ZF flag in the rFLAGS register to 1. Otherwise, it copies the value in the first operand to the AL, AX, EAX, or RAX register and clears the ZF flag to 0.

The OF, SF, AF, PF, and CF flags are set to reflect the results of the compare.

The forms of the CMPXCHG instruction that write to memory support the LOCK prefix. For details about the LOCK prefix, see “Lock Prefix” on page 10.

Mnemonic	Opcode	Description
CMPXCHG <i>reg/mem8, reg8</i>	0F B0 /r	Compare AL register with an 8-bit register or memory location. If equal, copy the second operand to the first operand. Otherwise, copy the first operand to AL.
CMPXCHG <i>reg/mem16, reg16</i>	0F B1 /r	Compare AX register with a 16-bit register or memory location. If equal, copy the second operand to the first operand. Otherwise, copy the first operand to AX.
CMPXCHG <i>reg/mem32, reg32</i>	0F B1 /r	Compare EAX register with a 32-bit register or memory location. If equal, copy the second operand to the first operand. Otherwise, copy the first operand to EAX.
CMPXCHG <i>reg/mem64, reg64</i>	0F B1 /r	Compare RAX register with a 64-bit register or memory location. If equal, copy the second operand to the first operand. Otherwise, copy the first operand to RAX.

Related Instructions

CMPXCHG8B

rFLAGS Affected

ID	VIP	VIF	AC	VM	RF	NT	IOPL	OF	DF	IF	TF	SF	ZF	AF	PF	CF
								M				M	M	M	M	M
21	20	19	18	17	16	14	13–12	11	10	9	8	7	6	4	2	0
<i>Note: Bits 31–22, 15, 5, 3, and 1 are reserved. A flag set to 1 or cleared to 0 is M (modified). Unaffected flags are blank. Undefined flags are U.</i>																

Exceptions

Exception	Real	Virtual 8086	Protected	Cause of Exception
Stack, #SS	X	X	X	A memory address exceeded the stack segment limit or was non-canonical.
General protection, #GP	X	X	X	A memory address exceeded a data segment limit or was non-canonical.
			X	The destination operand was in a non-writable segment.
			X	A null data segment was used to reference memory.
Page fault, #PF		X	X	A page fault resulted from the execution of the instruction.
Alignment check, #AC		X	X	An unaligned memory reference was performed while alignment checking was enabled.

CMPXCHG8B Compare and Exchange Eight Bytes

Compares a 64-bit value in the EDX:EAX registers with a 64-bit value in the specified memory location. If the values are equal, the instruction copies the value in the ECX:EBX registers to the memory location and sets the zero flag (ZF) of the rFLAGS register to 1. Otherwise, it copies the value in memory to the EDX:EAX registers and clears ZF to 0.

The CMPXCHG8B instruction supports the LOCK prefix. For details about the LOCK prefix, see “Lock Prefix” on page 10.

Support for the CMPXCHG8B instruction depends on the processor implementation. To find out if a processor can execute the CMPXCHG8B instruction, use the CPUID instruction to determine whether bit 8 of CPUID standard function 1 or extended function 8000_0001h is set to 1.

If the effective operand size is 64-bit, this instruction raises an invalid opcode (#UD) exception.

Mnemonic	Opcode	Description
CMPXCHG8B <i>mem64</i>	0F C7 /1 <i>m64</i>	Compare EDX:EAX register to 64-bit memory location. If equal, set the zero flag (ZF) to 1 and copy the ECX:EBX register to the memory location. Otherwise, copy the memory location to EDX:EAX and clear the zero flag.

Related Instructions

CMPXCHG

rFLAGS Affected

ID	VIP	VIF	AC	VM	RF	NT	IOPL	OF	DF	IF	TF	SF	ZF	AF	PF	CF
													M			
21	20	19	18	17	16	14	13–12	11	10	9	8	7	6	4	2	0
<i>Note: Bits 31–22, 15, 5, 3, and 1 are reserved. A flag set to 1 or cleared to 0 is M (modified). Unaffected flags are blank. Undefined flags are U.</i>																

Exceptions

Exception	Real	Virtual 8086	Protected	Cause of Exception
Invalid opcode, #UD	X	X	X	The CMPXCH8B instruction is not supported, as indicated by bit 8 of CPUID standard function 1 or extended function 8000_0001h.
	X	X	X	The operand was a register.
			X	Effective operand size was 64-bit.
Stack, #SS	X	X	X	A memory address exceeded the stack segment limit or was non-canonical.
General protection, #GP	X	X	X	A memory address exceeded a data segment limit or was non-canonical.
			X	The destination operand was in a non-writable segment.
			X	A null data segment was used to reference memory.
Page fault, #PF		X	X	A page fault resulted from the execution of the instruction.
Alignment check, #AC		X	X	An unaligned memory reference was performed while alignment checking was enabled.

CPUID

Processor Identification

Provides information about the processor and its capabilities through a number of different functions. Software should load the number of the CPUID function to execute into the EAX register before executing the CPUID instruction. The processor returns information in the EAX, EBX, ECX, and EDX registers; the contents and format of these registers depend on the function.

The architecture supports CPUID information about *standard functions* and *extended functions*. The standard functions have numbers in the 0000_XXXXh series (for example, function 1). To determine the largest standard function number that a processor supports, execute CPUID function 0.

The extended functions have numbers in the 8000_XXXXh series (for example, function 8000_0001h). To determine the largest extended function number that a processor supports, execute CPUID function 8000_0000h. If the value returned in EAX is greater than 8000_0000h, the processor supports extended functions.

Software operating at any privilege level can execute the CPUID instruction to collect this information. In 64-bit mode, this instruction works the same as in legacy mode except that it zero-extends 32-bit register results to 64 bits.

CPUID is a serializing instruction.

Mnemonic	Opcode	Description
CPUID	OF A2	Executes the CPUID function whose number is in the EAX register.

Testing for the CPUID Instruction

To avoid an invalid-opcode exception (#UD) on those processor implementations that do not support the CPUID instruction, software must first test to determine if the CPUID instruction is supported. Support for the CPUID instruction is indicated by the ability to write the ID bit in the rFLAGS register. Normally, 32-bit software uses the PUSHFD and POPFD instructions in an attempt to write rFLAGS.ID. After reading the updated rFLAGS.ID bit, a comparison determines if the operation changed its value. If the value changed, the processor executing the code supports the CPUID instruction. If the value did not change, rFLAGS.ID is not writable, and the processor does not support the CPUID instruction.

The following code sample shows how to test for the presence of the CPUID instruction using 32-bit code.

```

pushfd                ; save EFLAGS
pop                   eax    ; store EFLAGS in EAX
mov                   ebx, eax ; save in EBX for later testing
xor                   eax, 00200000h ; toggle bit 21
push                 eax    ; push to stack
popfd                ; save changed EAX to EFLAGS
pushfd                ; push EFLAGS to TOS
pop                   eax    ; store EFLAGS in EAX
cmp                   eax, ebx ; see if bit 21 has changed
jz                    NO_CPUID ; if no change, no CPUID

```

Function 0: Processor Vendor and Largest Standard Function Number

All software using the CPUID instruction must execute function 0. This function returns the largest standard function number and the processor vendor.

0000_0000h EAX: Largest Standard Function Number. Function 0 loads EAX with the largest CPUID standard function number supported by the processor implementation.

0000_0000h EBX, EDX, and ECX: Processor Vendor. Function 0 loads a 12-character string into the EBX, EDX, and ECX registers identifying the processor vendor. For AMD processors, the string is AuthenticAMD. This string informs software that it should follow the AMD CPUID definition for subsequent CPUID function calls. If the function returns a another vendor's string, software must use that vendor's CPUID definition when interpreting the results of subsequent CPUID function calls. Table 3-1 shows the contents of the EBX, EDX, and ECX registers after executing function 0 on an AMD processor.

Table 3-1. Processor Vendor Return Values

Register	Return Value	ASCII Characters
EBX	6874_7541h	"h t u A"
EDX	6974_6E65h	"i t n e"
ECX	444D_4163h	"D M A c"

Function 1: Processor Signature and Standard Features

Function 1 returns the processor signature and standard-feature bits.

0000_0001h EAX: Processor Signature. Function 1 returns the processor signature in the EAX register; the signature provides information on the processor revision (stepping)

level and processor model, as well as the instruction family that the processor supports.

Figure 3-1 shows the format of the EAX register following execution of CPUID standard function 1.

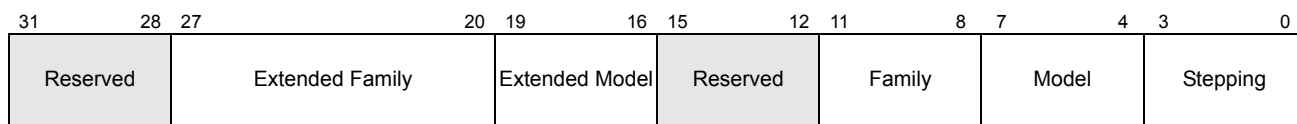

Bits	Mnemonic	Description
31–28	Reserved	
27–20		Extended Family
19–16		Extended Model
15–12	Reserved	
11–8		Family
7–4		Model
3–0		Stepping

Figure 3-1. Processor Signature (EAX Register)

The Extended Family and Extended Model fields extend the Family and Model fields, respectively, to accommodate larger family and model values. The method for computing the actual—or *effective*—family and model depends on the value of the Family field. The method for computing the effective family is shown in Table 3-2.

Table 3-2. Effective Family Computation

Family Field	How to Compute the Effective Family	Example																																								
Fh	Add the Extended Family field and the zero-extended Family field.	<div style="text-align: center;"> <p>Extended Family</p> <table style="margin: auto;"> <tr> <td style="border: 1px solid black; padding: 2px;">0</td><td style="border: 1px solid black; padding: 2px;">0</td><td style="border: 1px solid black; padding: 2px;">0</td><td style="border: 1px solid black; padding: 2px;">0</td><td style="border: 1px solid black; padding: 2px;">0</td><td style="border: 1px solid black; padding: 2px;">0</td><td style="border: 1px solid black; padding: 2px;">1</td><td style="border: 1px solid black; padding: 2px;">0</td> </tr> <tr> <td colspan="7" style="text-align: center;">7</td> <td style="text-align: right;">0</td> </tr> </table> <p style="margin: 5px 0;">+</p> <p>Family</p> <table style="margin: auto;"> <tr> <td style="border: 1px solid black; padding: 2px;">1</td><td style="border: 1px solid black; padding: 2px;">1</td><td style="border: 1px solid black; padding: 2px;">1</td><td style="border: 1px solid black; padding: 2px;">1</td> </tr> <tr> <td colspan="3" style="text-align: center;">3</td> <td style="text-align: right;">0</td> </tr> </table> <p style="margin: 5px 0;">Effective Family</p> <table style="margin: auto;"> <tr> <td style="border: 1px solid black; padding: 2px;">0</td><td style="border: 1px solid black; padding: 2px;">0</td><td style="border: 1px solid black; padding: 2px;">0</td><td style="border: 1px solid black; padding: 2px;">1</td><td style="border: 1px solid black; padding: 2px;">0</td><td style="border: 1px solid black; padding: 2px;">0</td><td style="border: 1px solid black; padding: 2px;">0</td><td style="border: 1px solid black; padding: 2px;">1</td> </tr> <tr> <td colspan="7" style="text-align: center;">7</td> <td style="text-align: right;">0</td> </tr> </table> <p style="text-align: right; font-size: small;">513-329.eps</p> </div>	0	0	0	0	0	0	1	0	7							0	1	1	1	1	3			0	0	0	0	1	0	0	0	1	7							0
0	0	0	0	0	0	1	0																																			
7							0																																			
1	1	1	1																																							
3			0																																							
0	0	0	1	0	0	0	1																																			
7							0																																			
Less than Fh	Use the Family field as the effective family.	<div style="text-align: center;"> <p>Family</p> <table style="margin: auto;"> <tr> <td style="border: 1px solid black; padding: 2px;">0</td><td style="border: 1px solid black; padding: 2px;">1</td><td style="border: 1px solid black; padding: 2px;">1</td><td style="border: 1px solid black; padding: 2px;">0</td> </tr> <tr> <td colspan="2" style="text-align: center;">3</td> <td colspan="2" style="text-align: right;">0</td> </tr> </table> <p style="margin: 5px 0;">↓</p> <p>Effective Family</p> <table style="margin: auto;"> <tr> <td style="border: 1px solid black; padding: 2px;">0</td><td style="border: 1px solid black; padding: 2px;">1</td><td style="border: 1px solid black; padding: 2px;">1</td><td style="border: 1px solid black; padding: 2px;">0</td> </tr> <tr> <td colspan="2" style="text-align: center;">3</td> <td colspan="2" style="text-align: right;">0</td> </tr> </table> <p style="text-align: right; font-size: small;">513-330.eps</p> </div>	0	1	1	0	3		0		0	1	1	0	3		0																									
0	1	1	0																																							
3		0																																								
0	1	1	0																																							
3		0																																								

The method for computing the effective model is shown in Table 3-3 on page 120.

Table 3-3. Effective Model Computation

Family Field	How to Compute the Effective Model	Example																																
Fh	Shift the Extended Model field four bits to the left and add it to the Model field.	<p>Extended Model</p> <table border="1" style="margin-left: 40px;"> <tr><td>0</td><td>1</td><td>0</td><td>0</td></tr> <tr><td style="text-align: center;">3</td><td></td><td></td><td style="text-align: center;">0</td></tr> </table> <p style="margin-left: 100px;">+</p> <p>Model</p> <table border="1" style="margin-left: 100px;"> <tr><td>0</td><td>0</td><td>1</td><td>0</td></tr> <tr><td style="text-align: center;">3</td><td></td><td></td><td style="text-align: center;">0</td></tr> </table> <p style="margin-left: 40px;">Effective Model</p> <table border="1" style="margin-left: 40px;"> <tr><td>0</td><td>1</td><td>0</td><td>0</td><td>0</td><td>0</td><td>1</td><td>0</td></tr> <tr><td style="text-align: center;">7</td><td></td><td></td><td></td><td></td><td></td><td></td><td style="text-align: center;">0</td></tr> </table> <p style="text-align: right; margin-right: 20px;"><small>513-331.eps</small></p>	0	1	0	0	3			0	0	0	1	0	3			0	0	1	0	0	0	0	1	0	7							0
0	1	0	0																															
3			0																															
0	0	1	0																															
3			0																															
0	1	0	0	0	0	1	0																											
7							0																											
Less than Fh	Use the Model field as the effective model.	<p>Model</p> <table border="1" style="margin-left: 40px;"> <tr><td>1</td><td>0</td><td>1</td><td>0</td></tr> <tr><td style="text-align: center;">3</td><td></td><td></td><td style="text-align: center;">0</td></tr> </table> <p style="text-align: center; margin-left: 40px;">↓</p> <p>Effective Model</p> <table border="1" style="margin-left: 40px;"> <tr><td>1</td><td>0</td><td>1</td><td>0</td></tr> <tr><td style="text-align: center;">3</td><td></td><td></td><td style="text-align: center;">0</td></tr> </table> <p style="text-align: right; margin-right: 20px;"><small>513-332.eps</small></p>	1	0	1	0	3			0	1	0	1	0	3			0																
1	0	1	0																															
3			0																															
1	0	1	0																															
3			0																															

0000_0001h EBX: Initial APIC ID, CLFLUSH Size, and Brand ID. Function 1 returns information on the initial value of the physical ID register associated with the advanced programmable interrupt controller (APIC), the size of the cache line flushed by the CLFLUSH instruction, and the processor brand.

Figure 3-2 shows the format of the EBX register following execution of CUID standard function 1.

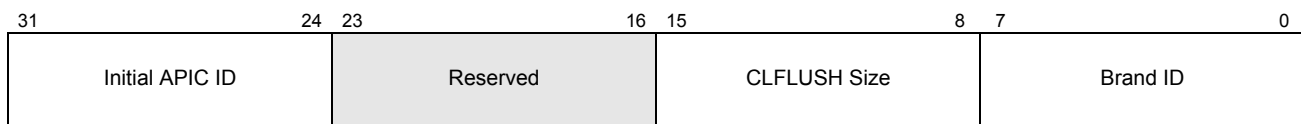

Bits	Mnemonic	Description
31-24		Initial APIC ID
23-16	Reserved	
15-8		CLFLUSH Size
7-0		Brand ID

Figure 3-2. Initial APIC ID, CLFLUSH Size, and Brand ID (EBX Register)

The Initial APIC ID field contains the initial value of the processor’s local APIC physical ID register. This value is composed of the Northbridge NodeID (bits 26-24)

and the CPU number within the node (bits 31–27). Subsequent writes by software to the local APIC physical ID register do not change the value of the Initial APIC ID field.

The CLFLUSH Size field gives the size (in quadwords) of the cache line that is flushed by the CLFLUSH instruction. This field is implemented only if the CLFLUSH instruction is supported. To determine if the CLFLUSH instruction is supported, test the CLFLUSH Instruction bit provided by function 1 feature flags.

The Brand ID field identifies a processor with a unique set of features as a specific brand. The BIOS uses the Brand ID field to program the processor name string that is returned by functions 8000_0002h–8000_0004h. If the Brand ID field is 0, the processor does not support the Brand ID feature.

0000_0001h ECX. For standard function 1, the ECX register is reserved.

0000_0001h EDX: Standard Feature Support. Function 1 returns standard-feature bits in the EDX register. The value of each bit indicates whether support for a specific feature is present on the processor implementation. If the value of a bit is 1, the feature is supported. If the value is 0, the feature is not supported.

Table 3-4 summarizes the standard-feature bits returned in the EDX register for function 1.

Table 3-4. CPUID Standard Feature Support (Standard Function 1)

EDX Bit	Feature (feature is supported if bit is set to 1)
0	On-Chip x87-Instruction Unit.
1	Virtual-Mode Extensions. See “Virtual Interrupts” in Volume 2.
2	Debugging Extensions. See “Software-Debug Resources” in Volume 2.
3	Page-Size Extensions (PSE). See “Page-Size Extensions (PSE) Bit” in Volume 2.
4	Time-Stamp Counter. See “Time-Stamp Counter” in Volume 2.
5	AMD K86 Model-Specific Registers (MSRs), with RDMSR and WRMSR Instructions. See “Model-Specific Registers (MSRs)” in Volume 2.
6	Physical-Address Extensions (PAE). See “Physical-Address Extensions (PAE) Bit” in Volume 2.
7	Machine Check Exception. See “Handling Machine Check Exceptions” in Volume 2.
8	CMPXCHG8B Instruction.

Table 3-4. CPUID Standard Feature Support (Standard Function 1) (continued)

EDX Bit	Feature (feature is supported if bit is set to 1)
9	Advanced Programmable Interrupt Controller (APIC). BIOS must enable the local APIC. See the documentation for particular implementations of the architecture.
10	Reserved.
11	SYSENTER and SYSEXIT Instructions. These instructions have different implementations than the SYSCALL and SYSRET instructions indicated by bit 11 of extended function 8000_0001h. See “SYSENTER and SYSEXIT (Legacy Mode Only)” in Volume 2.
12	Memory-Type Range Registers (MTRRs). See “Memory-Type Range Registers” in Volume 2.
13	Page Global Extension. See “Global Pages” in Volume 2.
14	Machine Check Architecture. See “Machine Check Mechanism” in Volume 2.
15	Conditional Move Instructions. Indicates support for conditional move (CMOVcc) general-purpose instructions, and—if the on-chip x87-instruction-unit bit (bit 0) is also set—for the x87 floating-point conditional move (FCMOVcc) instructions.
16	Page Attribute Table (PAT). See “Memory-Type Range Registers” in Volume 2.
17	Page-Size Extensions (PSE). See “Page-Size Extensions (PSE) Bit” in Volume 2.
18	Reserved.
19	CLFLUSH Instruction. Indicates support for the CLFLUSH (writeback, if modified, and invalidate) general-purpose instruction.
20–22	Reserved.
23	MMX™ Instructions. Indicates support for the integer (MMX) 64-bit media instructions. For details, see Appendix D, “Instruction Subsets and CPUID Feature Sets.”
24	FXSAVE and FXRSTOR Instructions. See “FXSAVE and FXRSTOR Instructions” in Volume 2.
25	SSE Instructions. Indicates support for the SSE instructions, except that the SSE instructions indicated for the AMD Extensions to MMX Instructions feature (bit 22 of extended function 8000_0001h; see Table 3-5 on page 124) are implemented if bit 25 is cleared and bit 22 of extended function 8000_0001h is set. For details, see Appendix D, “Instruction Subsets and CPUID Feature Sets.”
26	SSE2 Instruction Extensions. Indicates support for the SSE2 instructions. For details, see Appendix D, “Instruction Subsets and CPUID Feature Sets.”
27–31	Reserved.

Function 8000_0000h: Processor Vendor and Largest Extended Function Number

Function 8000_0000h mimics the behavior of function 0, except that function 8000_0000h returns the largest *extended* function number instead of the largest standard function number.

8000_0000h EAX: Largest Extended Function Number. Function 8000_0000h loads EAX with the largest CPUID extended function number supported by the processor implementation.

8000_0000h EBX, EDX, and ECX: Processor Vendor. Function 8000_0000h loads a 12-character string into the EBX, EDX, and ECX registers identifying the processor vendor. For AMD processors, the string is *AuthenticAMD*. This string informs software that it should follow the AMD CPUID definition for subsequent CPUID function calls. If the function returns a another vendor's string, software must use that vendor's CPUID definition when interpreting the results of subsequent CPUID function calls. Table 3-1 on page 118 shows the contents of the EBX, EDX, and ECX registers after executing function 8000_0000h on an AMD processor.

Function 8000_0001h: Processor Signature and AMD Features

Like function 1, function 8000_0001h returns the processor signature and feature bits. However, the feature bits returned by this function include a subset of the bits reported by standard function 1, along with additional bits for AMD features.

8000_0001h EAX: Processor Signature. Function 8000_0001h returns the processor signature in the EAX register; the signature provides information on the processor revision (stepping) level and processor model, as well as the instruction family that the processor supports.

Figure 3-1 on page 119 shows the format of the EAX register following execution of CPUID extended function 8000_0001h. (The value returned in the EAX register for function 8000_0001h is the same as the value returned by standard function 1.)

8000_0001h EBX and ECX. For function 8000_0001h, the EBX and ECX registers are reserved.

8000_0001h EDX: AMD Feature Support. Function 8000_0001h returns information about AMD features—those features that were originally implemented by AMD—in the EDX register. The value of each bit indicates whether support for a specific feature is present on the processor implementation. If the value of a bit is 1, the feature is supported. If the value is 0, the feature is not supported.

Function 8000_0001h also duplicates some of the standard-feature bits from function 1 in the EDX register, but this practice is outdated. Any new feature that is

first implemented by a given vendor is now reported only by a function assigned to that vendor.

Table 3-5 on page 124 summarizes the feature bits returned in the EDX register for function 8000_0001h. The right-most column of this table indicates whether a given bit has the same meaning in function 1. If the bit has the same meaning, use function 1 to test whether the feature is supported. For a list of the feature bits returned by standard function 1, see Table 3-4 on page 121.

Table 3-5. CPUID AMD Feature Support (Extended Function 8000_0001h)

EDX Bit	Feature (feature is supported if bit is set to 1)	Same as Function 1 (Table 3-4) ¹
0	On-Chip x87-Instruction Unit.	yes
1	Virtual-Mode Extensions. See "Virtual Interrupts" in Volume 2.	yes
2	Debugging Extensions. See "Software-Debug Resources" in Volume 2.	yes
3	Page-Size Extensions (PSE). See "Page-Size Extensions (PSE) Bit" in Volume 2.	yes
4	Time-Stamp Counter. See "Time-Stamp Counter" in Volume 2.	yes
5	AMD K86 Model-Specific Registers (MSRs), with RDMSR and WRMSR Instructions. See "Model-Specific Registers (MSRs)" in Volume 2.	yes
6	Physical-Address Extensions (PAE). See "Physical-Address Extensions (PAE) Bit" in Volume 2.	yes
7	Machine Check Exception. See "Handling Machine Check Exceptions" in Volume 2.	yes
8	CMPXCHG8B Instruction.	yes
9	Advanced Programmable Interrupt Controller (APIC). BIOS must enable the local APIC. See the documentation for particular implementations of the architecture.	yes
10	Reserved.	no
11	SYSCALL and SYSRET Instructions. These instructions have different implementations than the SYSENTER and SYSEXIT instructions indicated by bit 11 of standard function 1. For additional information, see "Fast System Call and Return" in Volume 2.	no
12	Memory-Type Range Registers (MTRRs). See "Memory-Type Range Registers" in Volume 2.	yes
13	Page Global Extension. See "Global Pages" in Volume 2.	yes

Note:

1. If a bit has the same meaning for function 1 as it does for function 8000_0001h, the processor sets or clears the bit identically for both functions.

Table 3-5. CPUID AMD Feature Support (Extended Function 8000_0001h) (continued)

EDX Bit	Feature (feature is supported if bit is set to 1)	Same as Function 1 (Table 3-4) ¹
14	Machine Check Architecture. See "Machine Check Mechanism" in Volume 2.	yes
15	Conditional Move Instructions. Indicates support for conditional move (CMOVcc) general-purpose instructions, and—if the on-chip x87-instruction-unit bit (bit 0) is also set—for the x87 floating-point conditional move (FCMOVcc) instructions.	yes
16	Page Attribute Table (PAT). See "Memory-Type Range Registers" in Volume 2.	yes
17	Page-Size Extensions (PSE). See "Page-Size Extensions (PSE) Bit" in Volume 2.	yes
18–19	Reserved.	no
20	No-Execute Page Protection. See "No Execute (NX) Bit" in Volume 2.	no
21	Reserved.	no
22	AMD Extensions to MMX™ Instructions. Indicates support for the AMD extensions to the integer (MMX) 64-bit media instructions, including support for certain SSE and SSE2 instructions. See Appendix D, "Instruction Subsets and CPUID Feature Sets," for details.	no
23	MMX™ Instructions. Indicates support for the integer (MMX) 64-bit media instructions. For details, see Appendix D, "Instruction Subsets and CPUID Feature Sets."	yes
24	FXSAVE and FXRSTOR Instructions. See "FXSAVE and FXRSTOR Instructions" in Volume 2.	yes
25	Fast FXSAVE/FXRSTOR. See "FXSAVE and FXRSTOR Instructions" in Volume 2.	no
26–28	Reserved.	no
29	Long Mode. See "Long Mode" in Volume 2.	no
30	AMD Extensions to 3DNow!™ Instructions. Indicates support for the AMD extensions to the floating-point (3DNow!) 64-bit media instructions. For details, see Appendix D, "Instruction Subsets and CPUID Feature Sets."	no
31	AMD 3DNow!™ Instructions. Indicates support for the floating-point (3DNow!) 64-bit media instructions. For details, see Appendix D, "Instruction Subsets and CPUID Feature Sets."	no

Note:

1. If a bit has the same meaning for function 1 as it does for function 8000_0001h, the processor sets or clears the bit identically for both functions.

Functions 8000_0002h–8000_0004h: Processor Name

Functions 8000_0002h, 8000_0003h, and 8000_0004h together return an ASCII string containing the name of the processor implementation. Software can simply call these three functions in numerical order to obtain a 48-character ASCII name string.

Although the name string can be up to 48 characters in length, shorter names have unused byte locations filled with the ASCII null character (00h).

Note: The BIOS must program the name string before these functions are executed; otherwise, these functions return the default processor name string (48 ASCII null characters).

The name string returned by these functions is in little-endian format. Function 8000_0002h returns the first 16 characters of the name and function 8000_0004h returns the last 16 characters. For each of the three groups of 16 characters, the functions return the name (in order of least-significant to most-significant byte) in the EAX, EBX, ECX, and EDX registers. The first character resides in the least-significant byte of EAX, and the last character resides in the most-significant byte of EDX.

Table 3-6 on page 126 gives an example of the return values and their equivalent ASCII characters for a processor with the following name string:

AMD Athlon(tm) processor

Table 3-6. Processor Name String Example

Function	Register	Return Value	ASCII Characters
8000_0002h	EAX	2044_4D41h	"space D M A"
	EBX	6C68_7441h	"l h t A"
	ECX	7428_6E6Fh	"t (n o"
	EDX	7020_296Dh	"p space) m"
8000_0003h	EAX	6563_6F72h	"e c o r"
	EBX	726F_7373h	"r o s s"
	ECX	0000_0000h	
	EDX	0000_0000h	
8000_0004h	EAX	0000_0000h	
	EBX	0000_0000h	
	ECX	0000_0000h	
	EDX	0000_0000h	

Functions 8000_0005h and 8000_0006h: Cache Information

The CPUID functions 8000_0005h and 8000_0006h provide cache and TLB information. These functions are useful to diagnostic software that displays

information about the system and the configuration of the processor implementation, including cache size and organization. For more information about the TLB and on-chip caches, see “Translation-Lookaside Buffer (TLB)” in Volume 2 and “Memory Caches” in Volume 2.

Function 8000_0005h returns information about the TLBs and L1 caches integrated on the processor. Tables 3-7, 3-8, 3-9, and 3-10, all on page 128, show the register formats for the information returned by function 8000_0005h.

In these tables, the associativity field is encoded as follows:

- 00h—Reserved.
- 01h—Direct mapped.
- 02h through FEh—The value represents the actual associativity. For example, a value of 04h indicates 4-way associativity.
- FFh—Fully associative.

Table 3-7. CPUID TLB Bits for 2-Mbyte and 4-Mbyte Pages

Register	Data TLB		Instruction TLB	
	Associativity	Number of Entries ¹	Associativity	Number of Entries ¹
EAX	Bits 31–24	Bits 23–16	Bits 15–8	Bits 7–0

Note:

- The number of entries returned is the number of entries available for the 2-Mbyte page size. The 4-Mbyte pages may require two 2-Mbyte entries, depending on the implementation, so the number of entries available for the 4-Mbyte page size would be one-half the returned value.

Table 3-8. CPUID TLB Bits for 4-Kbyte Pages

Register	Data TLB		Instruction TLB	
	Associativity	Number of Entries	Associativity	Number of Entries
EBX	Bits 31–24	Bits 23–16	Bits 15–8	Bits 7–0

Table 3-9. CPUID L1 Data Cache Bits

Register	L1 Data Cache			
	Size (Kbytes)	Associativity	Lines Per Tag	Line Size (Bytes)
ECX	Bits 31–24	Bits 23–16	Bits 15–8	Bits 7–0

Table 3-10. CPUID L1 Instruction Cache Bits

Register	L1 Instruction Cache			
	Size (Kbytes)	Associativity	Lines Per Tag	Line Size (Bytes)
EDX	Bits 31–24	Bits 23–16	Bits 15–8	Bits 7–0

Function 8000_0006h returns information about the L2 cache integrated on the processor. Tables 3-11, 3-12, and 3-13 on page 129 show the register-content formats for the information returned by function 8000_0006h.

In these tables, the associativity field is encoded as follows:

- 00h—The L2 cache is off (disabled).
- 01h—Direct mapped.
- 02h—2-way associative.
- 04h—4-way associative.
- 06h—8-way associative.
- 08h—16-way associative.
- 0Fh—Fully associative.
- All other encodings are reserved.

Table 3-11. CPUID L2 TLB Bits for 2-Mbyte and 4-Mbyte Pages

Register	L2 Data TLB		L2 Instruction or Unified L2 TLB ¹	
	Associativity	Number of Entries ²	Associativity	Number of Entries ²
EAX	Bits 31–28	Bits 27–16	Bits 15–12	Bits 11–0

Notes:

1. The presence of a unified L2 TLB is indicated by a value of 0000h in the upper 16 bits of the EAX register. The unified L2 TLB information is contained in the lower 16 bits of the EAX register.
2. The number of entries returned is the number of entries available for the 2-Mbyte page size. The 4-Mbyte pages may require two 2-Mbyte entries, depending on the implementation, so the number of entries available for the 4-Mbyte page size would be one-half the returned value.

Table 3-12. CPUID L2 TLB Bits for 4-Kbyte Pages

Register	L2 Data TLB		L2 Instruction or Unified L2 TLB ¹	
	Associativity	Number of Entries	Associativity	Number of Entries
EBX	Bits 31–28	Bits 27–16	Bits 15–12	Bits 11–0

Note:

- The presence of a unified L2 TLB is indicated by a value of 0000h in the upper 16 bits of the EBX register. The unified L2 TLB information is contained in the lower 16 bits of the EBX register.

Table 3-13. CPUID L2 Cache Bits

Register	L2 Cache			
	Size (Kbytes)	Associativity	Lines Per Tag	Line Size (Bytes)
ECX	Bits 31–16	Bits 15–12	Bits 11–8	Bits 7–0

8000_0006h EDX. For function 8000_0006h, the EDX register is reserved.

Function 8000_0007h: Advanced Power Management Features

Function 8000_0007h returns information about the advanced-power-management features supported by the processor.

8000_0007h EAX, EBX, and ECX. For function 8000_0007h, the EAX, EBX, and ECX registers are reserved.

8000_0007h EDX. Function 8000_0007h returns information about advanced-power-management features in the EDX register. Figure 3-3 shows the format of the EDX register following execution of CPUID extended function 8000_0007h. Each bit indicates whether support for a specific feature is present on the processor implementation. If the value of a power-management-feature bit is 1, the feature is supported. If the value is 0, the feature is not supported.

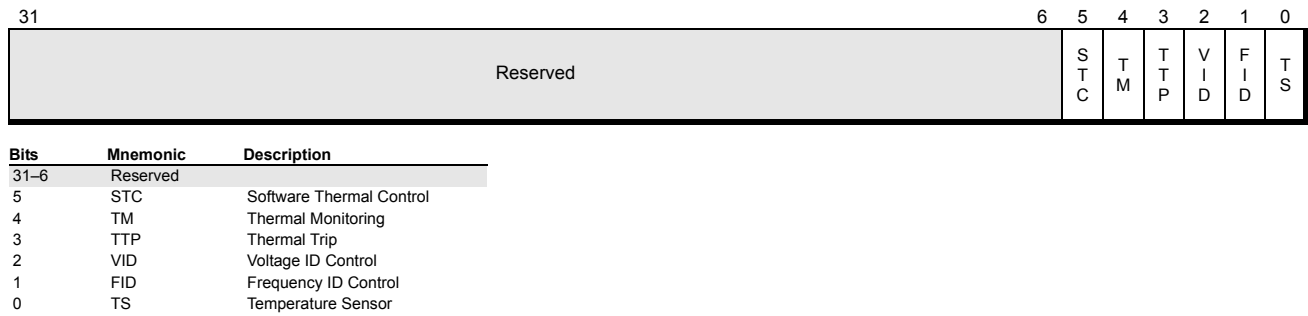

Figure 3-3. Advanced Power Management Features (EDX Register)

Function 8000_0008h: Address Sizes

Function 8000_0008h reports the maximum supported virtual-address and physical-address sizes.

8000_0008h EAX. Function 8000_0008h reports the address-size information in the EAX register. Table 3-14 on page 130 shows the format of the EAX register during execution of CPUID function 8000_0008h. The virtual-address and physical-address sizes that are returned indicate the address widths, in bits, supported by the processor implementation. The values returned by this function are not influenced by enabling or disabling either long mode or physical-address extensions (CR4.PAE).

Table 3-14. CPUID Long-Mode Address Sizes

Register	Long-Mode Address Sizes		
	Reserved	Virtual-Address Size	Physical-Address Size
EAX	Bits 31-16	Bits 15-8	Bits 7-0

8000_0008h EBX, ECX, and EDX. For function 8000_0008h, the EBX, ECX, and EDX registers are reserved.

Related Instructions

None

rFLAGS Affected

None

Exceptions

None

DAA Decimal Adjust after Addition

Adjusts the value in the AL register into a packed BCD result and sets the CF and AF flags in the rFLAGS register to indicate a decimal carry out of either nibble of AL.

Use this instruction to adjust the result of a byte ADD instruction that performed the binary addition of one 2-digit packed BCD values to another.

The instruction performs the adjustment by adding 06h to AL if the lower nibble is greater than 9 or if AF = 1. Then 60h is added to AL if the original AL was greater than 99h or if CF = 1.

If the lower nibble of AL was adjusted, the AF flag is set to 1. Otherwise AF is not modified. If the upper nibble of AL was adjusted, the CF flag is set to 1. Otherwise, CF is not modified. SF, ZF, and PF are set according to the final value of AL.

Using this instruction in 64-bit mode generates an invalid-opcode (#UD) exception.

Mnemonic	Opcode	Description
DAA	27	Decimal adjust AL. (Invalid in 64-bit mode.)

rFLAGS Affected

ID	VIP	VIF	AC	VM	RF	NT	IOPL	OF	DF	IF	TF	SF	ZF	AF	PF	CF
								U				M	M	M	M	M
21	20	19	18	17	16	14	13–12	11	10	9	8	7	6	4	2	0

Note: Bits 31–22, 15, 5, 3, and 1 are reserved. A flag set to 1 or cleared to 0 is M (modified). Unaffected flags are blank. Undefined flags are U.

Exceptions

Exception	Real	Virtual 8086	Protected	Cause of Exception
Invalid opcode, #UD			X	This instruction was executed in 64-bit mode.

DAS Decimal Adjust after Subtraction

Adjusts the value in the AL register into a packed BCD result and sets the CF and AF flags in the rFLAGS register to indicate a decimal borrow.

Use this instruction adjust the result of a byte SUB instruction that performed a binary subtraction of one 2-digit, packed BCD value from another.

This instruction performs the adjustment by subtracting 06h from AL if the lower nibble is greater than 9 or if AF = 1. Then 60h is subtracted from AL if the original AL was greater than 99h or if CF = 1.

If the adjustment changes the lower nibble of AL, the AF flag is set to 1; otherwise AF is not modified. If the adjustment results in a borrow for either nibble of AL, the CF flag is set to 1; otherwise CF is not modified. The SF, ZF, and PF flags are set according to the final value of AL.

Using this instruction in 64-bit mode generates an invalid-opcode (#UD) exception.

Mnemonic	Opcode	Description
DAS	2F	Decimal adjusts AL after subtraction. (Invalid in 64-bit mode.)

Related Instructions

DAA

rFLAGS Affected

ID	VIP	VIF	AC	VM	RF	NT	IOPL	OF	DF	IF	TF	SF	ZF	AF	PF	CF
								U				M	M	M	M	M
21	20	19	18	17	16	14	13-12	11	10	9	8	7	6	4	2	0

Note: Bits 31-22, 15, 5, 3, and 1 are reserved. A flag set to 1 or cleared to 0 is M (modified). Unaffected flags are blank. Undefined flags are U.

Exceptions

Exception	Real	Virtual 8086	Protected	Cause of Exception
Invalid opcode, #UD			X	This instruction was executed in 64-bit mode.

DEC Decrement by 1

Subtracts 1 from the specified register or memory location. The CF flag is not affected.

The one-byte forms of this instruction (opcodes 48 through 4F) are used as REX prefixes in 64-bit mode. See “REX Prefixes” on page 14.

The forms of the DEC instruction that write to memory support the LOCK prefix. For details about the LOCK prefix, see “Lock Prefix” on page 10.

To perform a decrement operation that updates the CF flag, use a SUB instruction with an immediate operand of 1.

Mnemonic	Opcode	Description
DEC <i>reg/mem8</i>	FE /1	Decrement the contents of an 8-bit register or memory location by 1.
DEC <i>reg/mem16</i>	FF /1	Decrement the contents of a 16-bit register or memory location by 1.
DEC <i>reg/mem32</i>	FF /1	Decrement the contents of a 32-bit register or memory location by 1.
DEC <i>reg/mem64</i>	FF /1	Decrement the contents of a 64-bit register or memory location by 1.
DEC <i>reg16</i>	48 + <i>rw</i>	Decrement the contents of a 16-bit register by 1. (See “REX Prefixes” on page 14.)
DEC <i>reg32</i>	48 + <i>rd</i>	Decrement the contents of a 32-bit register by 1. (See “REX Prefixes” on page 14.)

Related Instructions

INC, SUB

rFLAGS Affected

ID	VIP	VIF	AC	VM	RF	NT	IOPL	OF	DF	IF	TF	SF	ZF	AF	PF	CF
								M				M	M	M	M	
21	20	19	18	17	16	14	13–12	11	10	9	8	7	6	4	2	0

Note: Bits 31–22, 15, 5, 3, and 1 are reserved. A flag set to 1 or cleared to 0 is M (modified). Unaffected flags are blank. Undefined flags are U.

Exceptions

Exception	Real	Virtual 8086	Protected	Cause of Exception
Stack, #SS	X	X	X	A memory address exceeded the stack segment limit or was non-canonical.
General protection, #GP	X	X	X	A memory address exceed was data segment limit or was non-canonical.
			X	The destination operand was in a non-writable segment.
			X	A null data segment was used to reference memory.
Page fault, #PF		X	X	A page fault resulted from the execution of the instruction.
Alignment check, #AC		X	X	An unaligned memory reference was performed while alignment checking was enabled.

DIV Unsigned Divide

Divides the unsigned value in a register by the unsigned value in the specified register or memory location. The register to be divided depends on the size of the divisor.

When dividing a word, the dividend is in the AX register. The instruction stores the quotient in the AL register and the remainder in the AH register.

When dividing a doubleword, quadword, or double quadword, the most-significant word of the dividend is in the rDX register and the least-significant word is in the rAX register. After the division, the instruction stores the quotient in the rAX register and the remainder in the rDX register.

The following table summarizes the action of this instruction:

Division Size	Dividend	Divisor	Quotient	Remainder	Maximum Quotient
Word/byte	AX	reg/mem8	AL	AH	255
Doubleword/word	DX:AX	reg/mem16	AX	DX	65,535
Quadword/doubleword	EDX:EAX	reg/mem32	EAX	EDX	$2^{32} - 1$
Double quadword/quadword	RDX:RAX	reg/mem64	RAX	RDX	$2^{64} - 1$

The instruction truncates non-integral results towards 0 and the remainder is always less than the divisor. An overflow generates a #DE (divide error) exception, rather than setting the CF flag.

Division by zero generates a divide-by-zero exception.

Mnemonic	Opcode	Description
DIV <i>reg/mem8</i>	F6 /6	Perform unsigned division of AX by the contents of an 8-bit register or memory location and store the quotient in AL and the remainder in AH.
DIV <i>reg/mem16</i>	F7 /6	Perform unsigned division of DX:AX by the contents of a 16-bit register or memory operand store the quotient in AX and the remainder in DX.

Mnemonic	Opcode	Description
DIV <i>reg/mem32</i>	F7 /6	Perform unsigned division of EDX:EAX by the contents of a 32-bit register or memory location and store the quotient in EAX and the remainder in EDX.
DIV <i>reg/mem64</i>	F7 /6	Performs unsigned division of RDX:RAX by the contents of a 64-bit register or memory location and store the quotient in RAX and the remainder in RDX.

Related Instructions

MUL

rFLAGS Affected

ID	VIP	VIF	AC	VM	RF	NT	IOPL	OF	DF	IF	TF	SF	ZF	AF	PF	CF
								U				U	U	U	U	U
21	20	19	18	17	16	14	13–12	11	10	9	8	7	6	4	2	0
<i>Note: Bits 31–22, 15, 5, 3, and 1 are reserved. A flag set to 1 or cleared to 0 is M (modified). Unaffected flags are blank. Undefined flags are U.</i>																

Exceptions

Exception	Real	Virtual 8086	Protected	Cause of Exception
Divide by zero, #DE	X	X	X	The divisor operand was 0.
	X	X	X	The quotient was too large for the designated register.
Stack, #SS	X	X	X	A memory address exceeded the stack segment limit or was non-canonical.
General protection, #GP	X	X	X	A memory address exceeded a data segment limit or was non-canonical.
			X	A null data segment was used to reference memory.
Page fault, #PF		X	X	A page fault resulted from the execution of the instruction.
Alignment check, #AC		X	X	An unaligned memory reference was performed while alignment checking was enabled.

ENTER Create Procedure Stack Frame

Creates a stack frame for a procedure.

The first operand specifies the size of the stack frame allocated by the instruction.

The second operand specifies the nesting level (0 to 31—the value is automatically masked to 5 bits). For nesting levels of 1 or greater, the processor copies earlier stack frame pointers before adjusting the stack pointer. This action provides a called procedure with access points to other nested stack frames.

The 32-bit `enter N, 0` (a nesting level of 0) instruction is equivalent to the following 32-bit instruction sequence:

```

push  ebp          ; save current EBP
mov   ebp, esp     ; set stack frame pointer value
sub   esp, N       ; allocate space for local variables

```

The **ENTER** and **LEAVE** instructions provide support for block structured languages. The **LEAVE** instruction releases the stack frame on returning from a procedure.

In 64-bit mode, the operand size of **ENTER** defaults to 64 bits, and there is no prefix available for encoding a 32-bit operand size.

Mnemonic	Opcode	Description
<code>ENTER imm16, 0</code>	<code>C8 iw 00</code>	Create a procedure stack frame.
<code>ENTER imm16, 1</code>	<code>C8 iw 01</code>	Create a nested stack frame for a procedure.
<code>ENTER imm16, imm8</code>	<code>C8 iw ib</code>	Create a nested stack frame for a procedure.

Action

// See “Pseudocode Definitions” on page 49.

ENTER_START:

```

temp_ALLOC_SPACE = word-sized immediate specified in the instruction
                  (first operand), zero-extended to 64 bits
temp_LEVEL       = byte-sized immediate specified in the instruction
                  (second operand), zero-extended to 64 bits

```

```

temp_LEVEL = temp_LEVEL AND 0x1f
            // only keep 5 bits of level count

```

```

PUSH.v old_RBP

```



```

temp_RBP = RSP          // This value of RSP will eventually be loaded
                        // into RBP.
IF (temp_LEVEL>0)      // Push "temp_LEVEL" parameters to the stack.
{
  FOR (I=1; I<temp_LEVEL; I++)
                        // All but one of the parameters are copied
                        // from higher up on the stack.
  {
    temp_DATA = READ_MEM.v [SS:old_RBP-I*V]
    PUSH.v temp_DATA
  }
  PUSH.v temp_RBP      // The last parameter is the offset of the old
                        // value of RSP on the stack.
}
RSP.s = RSP - temp_ALLOC_SPACE // Leave "temp_ALLOC_SPACE" free bytes on
                                // the stack

WRITE_MEM.v [SS:RSP.s] = temp_unused // ENTER finishes with a memory write
                                        // check on the final stack pointer,
                                        // but no write actually occurs.

RBP.v = temp_RBP
EXIT

```

Related Instructions

LEAVE

rFLAGS Affected

None

Exceptions

Exception	Real	Virtual 8086	Protected	Cause of Exception
Stack, #SS	X	X	X	A memory address exceeded the stack-segment limit or was non-canonical.
Page fault, #PF		X	X	A page fault resulted from the execution of the instruction.
Alignment check, #AC		X	X	An unaligned memory reference was performed while alignment checking was enabled.

IDIV Signed Divide

Divides the signed value in a register by the signed value in the specified register or memory location. The register to be divided depends on the size of the divisor.

When dividing a word, the dividend is in the AX register. The instruction stores the quotient in the AL register and the remainder in the AH register.

When dividing a doubleword, quadword, or double quadword, the most-significant word of the dividend is in the rDX register and the least-significant word is in the rAX register. After the division, the instruction stores the quotient in the rAX register and the remainder in the rDX register.

The following table summarizes the action of this instruction:

Division Size	Dividend	Divisor	Quotient	Remainder	Quotient Range
Word/byte	AX	reg/mem8	AL	AH	-128 to +127
Doubleword/word	DX:AX	reg/mem16	AX	DX	-32,768 to +32,767
Quadword/doubleword	EDX:EAX	reg/mem32	EAX	EDX	-2^{31} to $2^{31}-1$
Double quadword/quadword	RDX:RAX	reg/mem64	RAX	RDX	-2^{63} to $2^{63}-1$

The instruction truncates non-integral results towards 0. The sign of the remainder is always the same as the sign of the dividend, and the absolute value of the remainder is less than the absolute value of the divisor. An overflow generates a #DE (divide error) exception, rather than setting the OF flag.

To avoid overflow problems, precede this instruction with a CBW, CWD, CDQ, or CQO instruction to sign-extend the dividend.

Mnemonic	Opcode	Description
IDIV <i>reg/mem8</i>	F6 /7	Perform signed division of AX by the contents of an 8-bit register or memory location and store the quotient in AL and the remainder in AH.
IDIV <i>reg/mem16</i>	F7 /7	Perform signed division of DX:AX by the contents of a 16-bit register or memory location and store the quotient in AX and the remainder in DX.

Mnemonic	Opcode	Description
IDIV <i>reg/mem32</i>	F7 /7	Perform signed division of EDX:EAX by the contents of a 32-bit register or memory location and store the quotient in EAX and the remainder in EDX.
IDIV <i>reg/mem64</i>	F7 /7	Perform signed division of RDX:RAX by the contents of a 64-bit register or memory location and store the quotient in RAX and the remainder in RDX.

Related Instructions

IMUL

rFLAGS Affected

ID	VIP	VIF	AC	VM	RF	NT	IOPL	OF	DF	IF	TF	SF	ZF	AF	PF	CF
								U				U	U	U	U	U
21	20	19	18	17	16	14	13–12	11	10	9	8	7	6	4	2	0

Note: Bits 31–22, 15, 5, 3, and 1 are reserved. A flag set to 1 or cleared to 0 is M (modified). Unaffected flags are blank. Undefined flags are U.

Exceptions

Exception	Real	Virtual 8086	Protected	Cause of Exception
Divide by zero, #DE	X	X	X	The divisor operand was 0.
	X	X	X	The quotient was too large for the designated register.
Stack, #SS	X	X	X	A memory address exceeded the stack segment limit or was non-canonical.
General protection, #GP	X	X	X	A memory address exceeded a data segment limit or was non-canonical.
			X	A null data segment was used to reference memory.
Page fault, #PF		X	X	A page fault resulted from the execution of the instruction.
Alignment check, #AC		X	X	An unaligned memory reference was performed while alignment checking was enabled.

IMUL Signed Multiply

Multiplies two signed operands. The number of operands determines the form of the instruction.

If a single operand is specified, the instruction multiplies the value in the specified general-purpose register or memory location by the value in the AL, AX, EAX, or RAX register (depending on the operand size) and stores the product in AX, DX:AX, EDX:EAX, or RDX:RAX, respectively.

If two operands are specified, the instruction multiplies the value in a general-purpose register (first operand) by an immediate value or the value in a general-purpose register or memory location (second operand) and stores the product in the first operand location.

If three operands are specified, the instruction multiplies the value in a general-purpose register or memory location (second operand), by an immediate value (third operand) and stores the product in a register (first operand).

The IMUL instruction sign-extends an immediate operand to the length of the other register/memory operand.

The CF and OF flags are set if, due to integer overflow, the double-width multiplication result cannot be represented in the half-width destination register. Otherwise the CF and OF flags are cleared.

Mnemonic	Opcode	Description
IMUL <i>reg/mem8</i>	F6 /5	Multiply the contents of AL by the contents of an 8-bit memory or register operand and put the signed result in AX.
IMUL <i>reg/mem16</i>	F7 /5	Multiply the contents of AX by the contents of a 16-bit memory or register operand and put the signed result in DX:AX.
IMUL <i>reg/mem32</i>	F7 /5	Multiply the contents of EAX by the contents of a 32-bit memory or register operand and put the signed result in EDX:EAX.
IMUL <i>reg/mem64</i>	F7 /5	Multiply the contents of RAX by the contents of a 64-bit memory or register operand and put the signed result in RDX:RAX.
IMUL <i>reg16, reg/mem16</i>	0F AF /r	Multiply the contents of a 16-bit destination register by the contents of a 16-bit register or memory operand and put the signed result in the 16-bit destination register.

Mnemonic	Opcode	Description
IMUL <i>reg32, reg/mem32</i>	0F AF /r	Multiply the contents of a 32-bit destination register by the contents of a 32-bit register or memory operand and put the signed result in the 32-bit destination register.
IMUL <i>reg64, reg/mem64</i>	0F AF /r	Multiply the contents of a 64-bit destination register by the contents of a 64-bit register or memory operand and put the signed result in the 64-bit destination register.
IMUL <i>reg16, reg/mem16, imm8</i>	6B /r <i>ib</i>	Multiply the contents of a 16-bit register or memory operand by a sign-extended immediate byte and put the signed result in the 16-bit destination register.
IMUL <i>reg32, reg/mem32, imm8</i>	6B /r <i>ib</i>	Multiply the contents of a 32-bit register or memory operand by a sign-extended immediate byte and put the signed result in the 32-bit destination register.
IMUL <i>reg64, reg/mem64, imm8</i>	6B /r <i>ib</i>	Multiply the contents of a 64-bit register or memory operand by a sign-extended immediate byte and put the signed result in the 64-bit destination register.
IMUL <i>reg16, reg/mem16, imm16</i>	69 /r <i>iw</i>	Multiply the contents of a 16-bit register or memory operand by a sign-extended immediate word and put the signed result in the 16-bit destination register.
IMUL <i>reg32, reg/mem32, imm32</i>	69 /r <i>id</i>	Multiply the contents of a 32-bit register or memory operand by a sign-extended immediate double and put the signed result in the 32-bit destination register.
IMUL <i>reg64, reg/mem64, imm32</i>	69 /r <i>id</i>	Multiply the contents of a 64-bit register or memory operand by a sign-extended immediate double and put the signed result in the 64-bit destination register.

Related Instructions

IDIV

rFLAGS Affected

ID	VIP	VIF	AC	VM	RF	NT	IOPL	OF	DF	IF	TF	SF	ZF	AF	PF	CF
								M				U	U	U	U	M
21	20	19	18	17	16	14	13–12	11	10	9	8	7	6	4	2	0
<p><i>Note: Bits 31–22, 15, 5, 3, and 1 are reserved. A flag set to 1 or cleared to 0 is M (modified). Unaffected flags are blank. Undefined flags are U.</i></p>																

Exceptions

Exception	Real	Virtual 8086	Protected	Cause of Exception
Stack, #SS	X	X	X	A memory address exceeded the stack segment limit or was non-canonical.
General protection, #GP	X	X	X	A memory address exceeded a data segment limit or was non-canonical.
			X	A null data segment was used to reference memory.
Page fault, #PF		X	X	A page fault resulted from the execution of the instruction.
Alignment check, #AC		X	X	An unaligned memory reference was performed while alignment checking was enabled.

IN Input from Port

Transfers a byte, word, or doubleword from an I/O port (second operand) to the AL, AX or EAX register (first operand). The port address can be an 8-bit immediate value (00h to FFh) or contained in the DX register (0000h to FFFFh).

The port is in the processor's I/O address space. For 8-bit I/O port accesses, the opcode determines the port size. For 16-bit and 32-bit accesses, the operand-size attribute determines the port size. If the operand size is 64-bits, IN reads only 32 bits from the I/O port.

If the CPL is higher than IOPL, or the mode is virtual mode, IN checks the I/O permission bitmap in the TSS before allowing access to the I/O port. (See Volume 2 for details on the TSS I/O permission bitmap.)

Mnemonic	Opcode	Description
IN AL, <i>imm8</i>	E4 <i>ib</i>	Input a byte from the port at the address specified by <i>imm8</i> and put it into the AL register.
IN AX, <i>imm8</i>	E5 <i>ib</i>	Input a word from the port at the address specified by <i>imm8</i> and put it into the AX register.
IN EAX, <i>imm8</i>	E5 <i>ib</i>	Input a doubleword from the port at the address specified by <i>imm8</i> and put it into the EAX register.
IN AL, DX	EC	Input a byte from the port at the address specified by the DX register and put it into the AL register.
IN AX, DX	ED	Input a word from the port at the address specified by the DX register and put it into the AX register.
IN EAX, DX	ED	Input a doubleword from the port at the address specified by the DX register and put it into the EAX register.

Related Instructions

INS_x, OUT, OUTS_x

rFLAGS Affected

None

Exceptions

Exception	Real	Virtual 8086	Protected	Cause of Exception
General protection, #GP		X		One or more I/O permission bits were set in the TSS for the accessed port.
			X	The CPL was greater than the IOPL and one or more I/O permission bits were set in the TSS for the accessed port.
Page fault, #PF		X	X	A page fault resulted from the execution of the instruction.

INC Increment by 1

Adds 1 to the specified register or memory location. The CF flag is not affected, even if the operand is incremented to 0000.

The one-byte forms of this instruction (opcodes 40 through 47) are used as REX prefixes in 64-bit mode. See “REX Prefixes” on page 14.

The forms of the INC instruction that write to memory support the LOCK prefix. For details about the LOCK prefix, see “Lock Prefix” on page 10.

To perform an increment operation that updates the CF flag, use an ADD instruction with an immediate operand of 1.

Mnemonic	Opcode	Description
INC <i>reg/mem8</i>	FE /0	Increment the contents of an 8-bit register or memory location by 1.
INC <i>reg/mem16</i>	FF /0	Increment the contents of a 16-bit register or memory location by 1.
INC <i>reg/mem32</i>	FF /0	Increment the contents of a 32-bit register or memory location by 1.
INC <i>reg/mem64</i>	FF /0	Increment the contents of a 64-bit register or memory location by 1.
INC <i>reg16</i>	40 + <i>rw</i>	Increment the contents of a 16-bit register by 1. (These opcodes are used as REX prefixes in 64-bit mode. See “REX Prefixes” on page 14.)
INC <i>reg32</i>	40 + <i>rd</i>	Increment the contents of a 32-bit register by 1. (These opcodes are used as REX prefixes in 64-bit mode. See “REX Prefixes” on page 14.)

Related Instructions

ADD, DEC

rFLAGS Affected

ID	VIP	VIF	AC	VM	RF	NT	IOPL	OF	DF	IF	TF	SF	ZF	AF	PF	CF
								M				M	M	M	M	
21	20	19	18	17	16	14	13–12	11	10	9	8	7	6	4	2	0

Note: Bits 31–22, 15, 5, 3, and 1 are reserved. A flag set to 1 or cleared to 0 is M (modified). Unaffected flags are blank. Undefined flags are U.

Exceptions

Exception	Real	Virtual 8086	Protected	Cause of Exception
Stack, #SS	X	X	X	A memory address exceeded the stack segment limit or was non-canonical.
General protection, #GP	X	X	X	A memory address exceeded a data segment limit or was non-canonical.
			X	The destination operand was in a non-writable segment.
			X	A null data segment was used to reference memory.
Page fault, #PF		X	X	A page fault resulted from the execution of the instruction.
Alignment check, #AC		X	X	An unaligned memory reference was performed while alignment checking was enabled.

INS **Input String**

INSB

INSW

INSD

Transfers data from the I/O port specified in the DX register to an input buffer specified in the rDI register and increments or decrements the rDI register according to the setting of the DF flag in the rFLAGS register.

If the DF flag is 0, the instruction increments rDI by 1, 2, or 4, depending on the number of bytes read. If the DF flag is 1, it decrements the pointer by 1, 2, or 4.

In 16-bit and 32-bit mode, the INS instruction always uses ES as the data segment. The ES segment cannot be overridden with a segment override prefix. In 64-bit mode, INS always uses the unsegmented memory space.

The INS instructions use the explicit memory operand (first operand) to determine the size of the I/O port, but always use ES:[rDI] for the location of the input buffer. The explicit register operand (second operand) specifies the I/O port address and must always be DX.

The INSB, INSW, and INSD instructions copy byte, word, and doubleword data, respectively, from the I/O port (0000h to FFFFh) specified in the DX register to the input buffer specified in the ES:rDI registers.

If the operand size is 64-bits, the instruction behaves as if the operand size were 32-bits.

If the CPL is higher than the IOPL or the mode is virtual mode, INSx checks the I/O permission bitmap in the TSS before allowing access to the I/O port. (See volume 2 for details on the TSS I/O permission bitmap.)

The INSx instructions support the REP prefix for block input of rCX bytes, words, or doublewords. For details about the REP prefix, see “Repeat Prefixes” on page 10.

Mnemonic	Opcode	Description
INS <i>mem8</i> , DX	6C	Input a byte from the port specified by DX, put it into the memory location specified in ES:rDI, and then increment or decrement rDI.
INS <i>mem16</i> , DX	6D	Input a word from the port specified by DX register, put it into the memory location specified in ES:rDI, and then increment or decrement rDI.
INS <i>mem32</i> , DX	6D	Input a doubleword from the port specified by DX, put it into the memory location specified in ES:rDI, and then increment or decrement rDI.
INSB	6C	Input a byte from the port specified by DX, put it into the memory location specified in ES:rDI, and then increment or decrement rDI.
INSW	6D	Input a word from the port specified by DX, put it into the memory location specified in ES:rDI, and then increment or decrement rDI.
INSD	6D	Input a doubleword from the port specified by DX, put it into the memory location specified in ES:rDI, and then increment or decrement rDI.

Related InstructionsIN, OUT, OUTS_x**rFLAGS Affected**

None

Exceptions

Exception	Real	Virtual 8086	Protected	Cause of Exception
General protection, #GP	X	X	X	A memory address exceeded a data segment limit or was non-canonical.
		X		One or more I/O permission bits were set in the TSS for the accessed port.
			X	The CPL was greater than the IOPL and one or more I/O permission bits were set in the TSS for the accessed port.
			X	A null data segment was used to reference memory.
		X	X	The destination operand was in a non-writable segment.
Page fault, #PF		X	X	A page fault resulted from the execution of the instruction.
Alignment check, #AC		X	X	An unaligned memory reference was performed while alignment checking was enabled.

INT Interrupt to Vector

Transfers execution to the interrupt handler specified by an 8-bit unsigned immediate value. This value is an interrupt vector number (00h to FFh), which the processor uses as an index into the interrupt-descriptor table (IDT).

For detailed descriptions of the steps performed by `INT n` instructions, see the following:

- *Legacy-Mode Interrupts*: “Legacy Protected-Mode Interrupt Control Transfers” in Volume 2.
- *Long-Mode Interrupts*: “Long-Mode Interrupt Control Transfers” in Volume 2.

See also the descriptions of the `INT3` instruction on page 300 and the `INTO` instruction on page 160.

Mnemonic	Opcode	Description
<code>INT imm8</code>	<code>CD ib</code>	Call interrupt service routine specified by interrupt vector <code>imm8</code> .

Action

// See “Pseudocode Definitions” on page 49.

```
INT_N_START:
```

```
IF (REAL_MODE)
    INT_N_REAL
ELIF (PROTECTED_MODE)
    INT_N_PROTECTED
ELSE // (VIRTUAL_MODE)
    INT_N_VIRTUAL
```

```
INT_N_REAL:
    temp_int_n_vector = byte-sized interrupt vector specified in the instruction,
                        zero-extended to 64 bits

    temp_RIP = READ_MEM.w [idt:temp_int_n_vector*4]
                // read target CS:RIP from the real-mode idt
    temp_CS = READ_MEM.w [idt:temp_int_n_vector*4+2]

    PUSH.w old_RFLAGS
    PUSH.w old_CS
    PUSH.w next_RIP
```

```

IF (temp_RIP>CS.limit)
    EXCEPTION [#GP]

CS.sel = temp_CS
CS.base = temp_CS SHL 4

RFLAGS.AC,TF,IF,RF cleared
RIP = temp_RIP
EXIT

```

INT_N_PROTECTED:

```

temp_int_n_vector = byte-sized interrupt vector specified in the instruction,
                    zero-extended to 64 bits
temp_idt_desc = READ_IDT (temp_int_n_vector)

IF (temp_idt_desc.attr.type = 'taskgate')
    TASK_SWITCH // using tss selector in the task gate as the target tss

IF (LONG_MODE) // The size of the gate controls the size of the
                // stack pushes.
    V=8-byte // Long mode only uses 64-bit gates.
ELIF ((temp_idt_desc.attr.type = 'intgate32')
      || (temp_idt_desc.attr.type = 'trapgate32'))
    V=4-byte // Legacy mode, using a 32-bit gate
ELSE // gate is intgate16 or trapgate16
    V=2-byte // Legacy mode, using a 16-bit gate

temp_RIP = temp_idt_desc.offset

IF (LONG_MODE)
    // In long mode, we need to read the 2nd half of a
    // 16-byte interrupt-gate from the IDT, to get the
    // upper 32 bits of the target RIP
    {
        temp_upper = READ_MEM.q [idt:temp_int_n_vector*16+8]
        temp_RIP = tempRIP + (temp_upper SHL 32) // concatenate both halves of RIP
    }

CS = READ_DESCRIPTOR (temp_idt_desc.segment, intcs_chk)

IF (CS.attr.conforming=1)
    temp_CPL = CPL
ELSE
    temp_CPL = CS.attr.dpl

IF (CPL=temp_CPL) // no privilege-level change
    {
        IF (LONG_MODE)

```

```

{
    IF (temp_idt_desc.ist!=0)
        // In long mode, if the IDT gate specifies an IST pointer,
        // a stack-switch is always done
        RSP = READ_MEM.q [tss:ist_index*8+28]

        RSP = RSP AND 0xFFFFFFFFFFFFFFF0
            // In long mode, interrupts/exceptions align RSP to a
            // 16-byte boundary

        PUSH.q old_SS    // In long mode, SS:RSP is always pushed to the stack
        PUSH.q old_RSP

    }

    PUSH.v old_RFLAGS
    PUSH.v old_CS
    PUSH.v next_RIP

    IF ((64BIT_MODE) && (temp_RIP is non-canonical)
        || (!64BIT_MODE) && (temp_RIP > CS.limit))
        EXCEPTION [#GP(0)]

    RFLAGS.VM,NT,TF,RF cleared
    RFLAGS.IF cleared if interrupt gate

    RIP = temp_RIP
    EXIT
}
ELSE // (CPL > temp_CPL), changing privilege level
{
    CPL = temp_CPL

    temp_SS_desc:temp_RSP = READ_INNER_LEVEL_STACK_POINTER
        (CPL, temp_idt_desc.ist)

    IF (LONG_MODE)
        temp_RSP = temp_RSP AND 0xFFFFFFFFFFFFFFF0
            // in long mode, interrupts/exceptions align rsp
            // to a 16-byte boundary

    RSP.q = temp_RSP
    SS = temp_SS_desc

    PUSH.v old_SS // #SS on the following pushes uses SS.sel as error code
    PUSH.v old_RSP
    PUSH.v old_RFLAGS
    PUSH.v old_CS
    PUSH.v next_RIP

    IF ((64BIT_MODE) && (temp_RIP is non-canonical)
        || (!64BIT_MODE) && (temp_RIP > CS.limit))

```



```

        EXCEPTION [#GP(0)]

        RFLAGS.VM,NT,TF,RF cleared
        RFLAGS.IF cleared if interrupt gate
        RIP = temp_RIP
        EXIT
    }

```

INT_N_VIRTUAL:

```

temp_int_n_vector = byte-sized interrupt vector specified in the instruction,
                    zero-extended to 64 bits

IF (CR4.VME=0) // vme isn't enabled
{
    IF (RFLAGS.IOPL=3)
        INT_N_VIRTUAL_TO_PROTECTED
    ELSE
        EXCEPTION [#GP(0)]
}

temp_IRB_BASE = READ_MEM.w [tss:102] - 32
                // check the vme Int-n Redirection Bitmap (IRB), to see
                // if we should redirect this interrupt to a virtual-mode
                // handler
temp_VME_REDIRECTION_BIT = READ_BIT_ARRAY ([tss:temp_IRB_BASE],
                                           temp_int_n_vector)

IF (temp_VME_REDIRECTION_BIT=1)
{
    // the virtual-mode int-n bitmap bit is set, so don't
    // redirect this interrupt
    IF (RFLAGS.IOPL=3)
        INT_N_VIRTUAL_TO_PROTECTED
    ELSE
        EXCEPTION [#GP(0)]
}
ELSE // redirect interrupt through virtual-mode idt
{
    temp_RIP = READ_MEM.w [0:temp_int_n_vector*4]
                // read target CS:RIP from the virtual-mode idt at
                // linear address 0
    temp_CS = READ_MEM.w [0:temp_int_n_vector*4+2]

    IF (RFLAGS.IOPL < 3)
        old_RFLAGS = old_RFLAGS with VIF bit shifted into IF bit, and IOPL = 3

    PUSH.w old_RFLAGS
    PUSH.w old_CS
    PUSH.w next_RIP
}

```

```

    CS.sel = temp_CS
    CS.base = temp_CS SHL 4

    RFLAGS.TF,RF cleared
    RIP = temp_RIP          // RFLAGS.IF cleared if IOPL = 3
                          // RFLAGS.VIF cleared if IOPL < 3
    EXIT
}

```

INT_N_VIRTUAL_TO_PROTECTED:

```

temp_idt_desc = READ_IDT (temp_int_n_vector)
IF (temp_idt_desc.attr.type = 'taskgate')
    TASK_SWITCH // using tss selector in the task gate as the target tss

IF ((temp_idt_desc.attr.type = 'intgate32')
    || (temp_idt_desc.attr.type = 'trapgate32'))
    // the size of the gate controls the size of the stack pushes
    V=4-byte // legacy mode, using a 32-bit gate
ELSE // gate is intgate16 or trapgate16
    V=2-byte // legacy mode, using a 16-bit gate

temp_RIP = temp_idt_desc.offset
CS = READ_DESCRIPTOR (temp_idt_desc.segment, intcs_chk)

IF (CS.attr.dpl!=0) // Handler must run at CPL 0.
    EXCEPTION [#GP(CS.sel)]

CPL = 0

temp_ist = 0 // Legacy mode doesn't use ist pointers
temp_SS_desc:temp_RSP = READ_INNER_LEVEL_STACK_POINTER (CPL, temp_ist)

RSP.q = temp_RSP
SS = temp_SS_desc

PUSH.v old_GS // #SS on the following pushes use SS.sel as error code.
PUSH.v old_FS
PUSH.v old_DS
PUSH.v old_ES
PUSH.v old_SS
PUSH.v old_RSP
PUSH.v old_RFLAGS // Pushed with RF clear.
PUSH.v old_CS
PUSH.v next_RIP

IF (temp_RIP > CS.limit)
    EXCEPTION [#GP(0)]

DS = NULL // can't use virtual-mode selectors in protected mode

```

```

ES = NULL    // can't use virtual-mode selectors in protected mode
FS = NULL    // can't use virtual-mode selectors in protected mode
GS = NULL    // can't use virtual-mode selectors in protected mode

```

```

RFLAGS.VM,NT,TF,RF cleared
RFLAGS.IF cleared if interrupt gate

```

```

RIP = temp_RIP
EXIT

```

Related Instructions

INT 3, INTO, BOUND

rFLAGS Affected

If a task switch occurs, all flags are modified. Otherwise settings are as follows:

ID	VIP	VIF	AC	VM	RF	NT	IOPL	OF	DF	IF	TF	SF	ZF	AF	PF	CF
		M	M	M	0	M				M	0					
21	20	19	18	17	16	14	13-12	11	10	9	8	7	6	4	2	0

Note: Bits 31-22, 15, 5, 3, and 1 are reserved. A flag set to 1 or cleared to 0 is M (modified). Unaffected flags are blank. Undefined flags are U.

Exceptions

Exception	Real	Virtual 8086	Protected	Cause of Exception
Invalid TSS, #TS (selector)		X	X	As part of a stack switch, the target stack segment selector or rSP in the TSS was beyond the TSS limit.
		X	X	As part of a stack switch, the target stack segment selector in the TSS was a null selector.
		X	X	As part of a stack switch, the target stack segment selector's TI bit was set, but the LDT selector was a null selector.
		X	X	As part of a stack switch, the target stack segment selector in the TSS was beyond the limit of the GDT or LDT descriptor table.
		X	X	As part of a stack switch, the target stack segment selector in the TSS contained a RPL that was not equal to its DPL.
		X	X	As part of a stack switch, the target stack segment selector in the TSS contained a DPL that was not equal to the CPL of the code segment selector.
Segment not present, #NP (selector)		X	X	As part of a stack switch, the target stack segment selector in the TSS was not a writable segment.
		X	X	The accessed code segment, interrupt gate, trap gate, task gate, or TSS was not present.
Stack, #SS	X	X	X	A memory address exceeded the stack segment limit or was non-canonical, and no stack switch occurred.
Stack, #SS (selector)		X	X	After a stack switch, a memory address exceeded the stack segment limit or was non-canonical.
		X	X	As part of a stack switch, the SS register was loaded with a non-null segment selector and the segment was marked not present.
General protection, #GP	X	X	X	A memory address exceeded a data segment limit or was non-canonical.
	X	X	X	The target offset exceeded the code segment limit or was non-canonical.
		X		The IOPL was less than 3 and CR4.VME was 0.
		X		IOPL was less than 3, CR4.VME was 1, and the corresponding bit in the VME interrupt redirection bitmap was 1.

Exception	Real	Virtual 8086	Protected	Cause of Exception
General protection, #GP (selector)	X	X	X	The interrupt vector was beyond the limit of IDT.
		X	X	The descriptor in the IDT was not an interrupt, trap, or task gate in legacy mode or not a 64-bit interrupt or trap gate in long mode.
		X	X	The DPL of the interrupt, trap, or task gate descriptor was less than the CPL.
		X	X	The segment selector specified by the interrupt or trap gate had its TI bit set, but the LDT selector was a null selector.
		X	X	The segment descriptor specified by the interrupt or trap gate exceeded the descriptor table limit or was a null selector.
		X	X	The segment descriptor specified by the interrupt or trap gate was not a code segment in legacy mode, or not a 64-bit code segment in long mode.
		X	X	The DPL of the segment specified by the interrupt or trap gate was greater than the CPL.
		X	X	The DPL of the segment specified by the interrupt or trap gate pointed was not 0 or it was a conforming segment.
Page fault, #PF		X	X	A page fault resulted from the execution of the instruction.
Alignment check, #AC		X	X	An unaligned memory reference was performed while alignment checking was enabled.

INTO Interrupt to Overflow Vector

Checks the overflow flag (OF) in the rFLAGS register and calls the overflow exception (#OF) handler if the OF flag is set to 1. This instruction has no effect if the OF flag is cleared to 0. The INTO instruction detects overflow in signed number addition. See *AMD64 Architecture Programmer's Manual Volume 1: Application Programming* for more information on the OF flag.

Using this instruction in 64-bit mode generates an invalid-opcode exception.

For detailed descriptions of the steps performed by INT instructions, see the following:

- *Legacy-Mode Interrupts*: “Legacy Protected-Mode Interrupt Control Transfers” in Volume 2.
- *Long-Mode Interrupts*: “Long-Mode Interrupt Control Transfers” in Volume 2.

Mnemonic	Opcode	Description
INTO	CE	Call overflow exception if the overflow flag is set. (Invalid in 64-bit mode.)

Action

```
IF (64BIT_MODE)
    EXCEPTION[#UD]
IF (RFLAGS.OF = 1) // #OF is a trap, and pushes the rIP of the instruction
    EXCEPTION [#OF] // following INTO.
EXIT
```

Related Instructions

INT, INT 3, BOUND

rFLAGS Affected

None.

Exceptions

Exception	Real	Virtual 8086	Protected	Cause of Exception
Overflow, #OF	X	X	X	The INTO instruction was executed with OF set to 1.
Invalid opcode, #UD			X	Instruction was executed in 64-bit mode.

Jcc Jump on Condition

Checks the status flags in the rFLAGS register and, if the flags meet the condition specified by the condition code in the mnemonic (*cc*), jumps to the target instruction located at the specified relative offset. Otherwise, execution continues with the instruction following the Jcc instruction.

Unlike the unconditional jump (JMP), conditional jump instructions have only two forms—*short and near conditional jumps*. Different opcodes correspond to different forms of one instruction. For example, the JO instruction (jump if overflow) has opcode 0Fh 80h for its near form and 70h for its short form, but the mnemonic is the same for both forms. The only difference is that the near form has a 16- or 32-bit relative displacement, while the short form always has an 8-bit relative displacement.

Mnemonics are provided to deal with the programming semantics of both signed and unsigned numbers. Instructions tagged A (above) and B (below) are intended for use in unsigned integer code; those tagged G (greater) and L (less) are intended for use in signed integer code.

If the jump is taken, the signed displacement is added to the rIP (of the following instruction) and the result is truncated to 16, 32, or 64 bits, depending on operand size.

In 64-bit mode, the operand size defaults to 64 bits. The processor sign-extends the 8-bit or 32-bit displacement value to 64 bits before adding it to the RIP.

These instructions cannot perform far jumps (to other code segments). To create a far-conditional-jump code sequence corresponding to a high-level language statement like:

```
IF A = B THEN GOTO FarLabel
```

where *FarLabel* is located in another code segment, use the opposite condition in a conditional short jump before an unconditional far jump. Such a code sequence might look like:

```
cmp    A,B           ; compare operands
jne    NextInstr     ; continue program if not equal
jmp    far FarLabel  ; far jump if operands are equal
```

```
NextInstr:           ; continue program
```

For details about control-flow instructions, see “Control Transfers” in Volume 1, and “Control-Transfer Privilege Checks” in Volume 2.

Mnemonic	Opcode	Description
<i>JO rel8off</i>	<i>70 cb</i>	Jump if overflow (OF = 1).
<i>JO rel16off</i>	<i>0F 80 cw</i>	
<i>JO rel32off</i>	<i>0F 80 cd</i>	
<i>JNO rel8off</i>	<i>71 cb</i>	Jump if not overflow (OF = 0).
<i>JNO rel16off</i>	<i>0F 81 cw</i>	
<i>JNO rel32off</i>	<i>0F 81 cd</i>	
<i>JB rel8off</i>	<i>72 cb</i>	Jump if below (CF = 1).
<i>JB rel16off</i>	<i>0F 82 cw</i>	
<i>JB rel32off</i>	<i>0F 82 cd</i>	
<i>JC rel8off</i>	<i>72 cb</i>	Jump if carry (CF = 1).
<i>JC rel16off</i>	<i>0F 82 cw</i>	
<i>JC rel32off</i>	<i>0F 82 cd</i>	
<i>JNAE rel8off</i>	<i>72 cb</i>	Jump if not above or equal (CF = 1).
<i>JNAE rel16off</i>	<i>0F 82 cw</i>	
<i>JNAE rel32off</i>	<i>0F 82 cd</i>	
<i>JNB rel8off</i>	<i>73 cb</i>	Jump if not below (CF = 0).
<i>JNB rel16off</i>	<i>0F 83 cw</i>	
<i>JNB rel32off</i>	<i>0F 83 cd</i>	
<i>JNC rel8off</i>	<i>73 cb</i>	Jump if not carry (CF = 0).
<i>JNC rel16off</i>	<i>0F 83 cw</i>	
<i>JNC rel32off</i>	<i>0F 83 cd</i>	
<i>JAE rel8off</i>	<i>73 cb</i>	Jump if above or equal (CF = 0).
<i>JAE rel16off</i>	<i>0F 83 cw</i>	
<i>JAE rel32off</i>	<i>0F 83 cd</i>	
<i>JZ rel8off</i>	<i>74 cb</i>	Jump if zero (ZF = 1).
<i>JZ rel16off</i>	<i>0F 84 cw</i>	
<i>JZ rel32off</i>	<i>0F 84 cd</i>	
<i>JE rel8off</i>	<i>74 cb</i>	Jump if equal (ZF = 1).
<i>JE rel16off</i>	<i>0F 84 cw</i>	
<i>JE rel32off</i>	<i>0F 84 cd</i>	
<i>JNZ rel8off</i>	<i>75 cb</i>	Jump if not zero (ZF = 0).
<i>JNZ rel16off</i>	<i>0F 85 cw</i>	
<i>JNZ rel32off</i>	<i>0F 85 cd</i>	
<i>JNE rel8off</i>	<i>75 cb</i>	Jump if not equal (ZF = 0).
<i>JNE rel16off</i>	<i>0F 85 cw</i>	
<i>JNE rel32off</i>	<i>0F 85 cd</i>	

Mnemonic	Opcode	Description
JBE <i>rel8off</i>	76 <i>cb</i>	Jump if below or equal (CF = 1 or ZF = 1).
JBE <i>rel16off</i>	0F 86 <i>cw</i>	
JBE <i>rel32off</i>	0F 86 <i>cd</i>	
JNA <i>rel8off</i>	76 <i>cb</i>	Jump if not above (CF = 1 or ZF = 1).
JNA <i>rel16off</i>	0F 86 <i>cw</i>	
JNA <i>rel32off</i>	0F 86 <i>cd</i>	
JNBE <i>rel8off</i>	77 <i>cb</i>	Jump if not below or equal (CF = 0 and ZF = 0).
JNBE <i>rel16off</i>	0F 87 <i>cw</i>	
JNBE <i>rel32off</i>	0F 87 <i>cd</i>	
JA <i>rel8off</i>	77 <i>cb</i>	Jump if above (CF = 0 and ZF = 0).
JA <i>rel16off</i>	0F 87 <i>cw</i>	
JA <i>rel32off</i>	0F 87 <i>cd</i>	
JS <i>rel8off</i>	78 <i>cb</i>	Jump if sign (SF = 1).
JS <i>rel16off</i>	0F 88 <i>cw</i>	
JS <i>rel32off</i>	0F 88 <i>cd</i>	
JNS <i>rel8off</i>	79 <i>cb</i>	Jump if not sign (SF = 0).
JNS <i>rel16off</i>	0F 89 <i>cw</i>	
JNS <i>rel32off</i>	0F 89 <i>cd</i>	
JP <i>rel8off</i>	7A <i>cb</i>	Jump if parity (PF = 1).
JP <i>rel16off</i>	0F 8A <i>cw</i>	
JP <i>rel32off</i>	0F 8A <i>cd</i>	
JPE <i>rel8off</i>	7A <i>cb</i>	Jump if parity even (PF = 1).
JPE <i>rel16off</i>	0F 8A <i>cw</i>	
JPE <i>rel32off</i>	0F 8A <i>cd</i>	
JNP <i>rel8off</i>	7B <i>cb</i>	Jump if not parity (PF = 0).
JNP <i>rel16off</i>	0F 8B <i>cw</i>	
JNP <i>rel32off</i>	0F 8B <i>cd</i>	
JPO <i>rel8off</i>	7B <i>cb</i>	Jump if parity odd (PF = 0).
JPO <i>rel16off</i>	0F 8B <i>cw</i>	
JPO <i>rel32off</i>	0F 8B <i>cd</i>	
JL <i>rel8off</i>	7C <i>cb</i>	Jump if less (SF \diamond OF).
JL <i>rel16off</i>	0F 8C <i>cw</i>	
JL <i>rel32off</i>	0F 8C <i>cd</i>	
JNGE <i>rel8off</i>	7C <i>cb</i>	Jump if not greater or equal (SF \diamond OF).
JNGE <i>rel16off</i>	0F 8C <i>cw</i>	
JNGE <i>rel32off</i>	0F 8C <i>cd</i>	
JNL <i>rel8off</i>	7D <i>cb</i>	Jump if not less (SF = OF).
JNL <i>rel16off</i>	0F 8D <i>cw</i>	
JNL <i>rel32off</i>	0F 8D <i>cd</i>	

Mnemonic	Opcode	Description
JGE <i>rel8off</i>	7D <i>cb</i>	Jump if greater or equal (SF = OF).
JGE <i>rel16off</i>	0F 8D <i>cw</i>	
JGE <i>rel32off</i>	0F 8D <i>cd</i>	
JLE <i>rel8off</i>	7E <i>cb</i>	Jump if less or equal (ZF = 1 or SF \diamond OF).
JLE <i>rel16off</i>	0F 8E <i>cw</i>	
JLE <i>rel32off</i>	0F 8E <i>cd</i>	
JNG <i>rel8off</i>	7E <i>cb</i>	Jump if not greater (ZF = 1 or SF \diamond OF).
JNG <i>rel16off</i>	0F 8E <i>cw</i>	
JNG <i>rel32off</i>	0F 8E <i>cd</i>	
JNLE <i>rel8off</i>	7F <i>cb</i>	Jump if not less or equal (ZF = 0 and SF = OF).
JNLE <i>rel16off</i>	0F 8F <i>cw</i>	
JNLE <i>rel32off</i>	0F 8F <i>cd</i>	
JG <i>rel8off</i>	7F <i>cb</i>	Jump if greater (ZF = 0 and SF = OF).
JG <i>rel16off</i>	0F 8F <i>cw</i>	
JG <i>rel32off</i>	0F 8F <i>cd</i>	

Related Instructions

JMP (Near), JMP (Far), JrCXZ

rFLAGS Affected

None

Exceptions

Exception	Real	Virtual 8086	Protected	Cause of Exception
General protection, #GP	X	X	X	The target offset exceeded the code segment limit or was non-canonical.

JCZX

JECZX

JRCZX

Jump if rCX Zero

Checks the contents of the count register (rCX) and, if 0, jumps to the target instruction located at the specified 8-bit relative offset. Otherwise, execution continues with the instruction following the JrCXZ instruction.

The size of the count register (CX, ECX, or RCX) depends on the address-size attribute of the JrCXZ instruction. Therefore, JRCZX can only be executed in 64-bit mode and JCZX cannot be executed in 64-bit mode.

If the jump is taken, the signed displacement is added to the rIP (of the following instruction) and the result is truncated to 16, 32, or 64 bits, depending on operand size.

In 64-bit mode, the operand size defaults to 64 bits. The processor sign-extends the 8-bit displacement value to 64 bits before adding it to the RIP.

For details about control-flow instructions, see “Control Transfers” in Volume 1, and “Control-Transfer Privilege Checks” in Volume 2.

Mnemonic	Opcode	Description
<i>JCZX rel8off</i>	<i>E3 cb</i>	Jump short if the 16-bit count register (CX) is zero.
<i>JECZX rel8off</i>	<i>E3 cb</i>	Jump short if the 32-bit count register (ECX) is zero.
<i>JRCZX rel8off</i>	<i>E3 cb</i>	Jump short if the 64-bit count register (RCX) is zero.

Related Instructions

Jcc, JMP (Near), JMP (Far)

rFLAGS Affected

None

Exceptions

Exception	Real	Virtual 8086	Protected	Cause of Exception
General protection, #GP	X	X	X	The target offset exceeded the code segment limit or was non-canonical

JMP (Near) Near Jump

Unconditionally transfers control to a new address without saving the current rIP value. This form of the instruction jumps to an address in the current code segment and is called a *near jump*. The target operand can specify a register, a memory location, or a label.

If the JMP target is specified in a register or memory location, then a 16-, 32-, or 64-bit rIP is read from the operand, depending on operand size. This rIP is zero-extended to 64 bits.

If the JMP target is specified by a displacement in the instruction, the signed displacement is added to the rIP (of the following instruction), and the result is truncated to 16, 32, or 64 bits depending on operand size. The signed displacement can be 8 bits, 16 bits, or 32 bits, depending on the opcode and the operand size.

For near jumps in 64-bit mode, the operand size defaults to 64 bits. The E9 opcode results in $RIP = RIP + 32\text{-bit signed displacement}$, and the FF /4 opcode results in $RIP = 64\text{-bit offset from register or memory}$. No prefix is available to encode a 32-bit operand size in 64-bit mode.

See JMP (Far) for information on far jumps—jumps to procedures located outside of the current code segment. For details about control-flow instructions, see “Control Transfers” in Volume 1, and “Control-Transfer Privilege Checks” in Volume 2.

Mnemonic	Opcode	Description
JMP <i>rel8off</i>	EB <i>cb</i>	Short jump with the target specified by an 8-bit signed displacement.
JMP <i>rel16off</i>	E9 <i>cw</i>	Near jump with the target specified by a 16-bit signed displacement.
JMP <i>rel32off</i>	E9 <i>cd</i>	Near jump with the target specified by a 32-bit signed displacement.
JMP <i>reg/mem16</i>	FF /4	Near jump with the target specified <i>reg/mem16</i> .
JMP <i>reg/mem32</i>	FF /4	Near jump with the target specified <i>reg/mem32</i> . (No prefix for encoding in 64-bit mode.)
JMP <i>reg/mem64</i>	FF /4	Near jump with the target specified <i>reg/mem64</i> .

Related Instructions

JMP (Far), Jcc, JrCX

rFLAGS Affected

None.

Exceptions

Exception	Real	Virtual 8086	Protected	Cause of Exception
Stack, #SS	X	X	X	A memory address exceeded the stack segment limit or was non-canonical.
General protection, #GP	X	X	X	A memory address exceeded a data segment limit or was non-canonical.
	X	X	X	The target offset exceeded the code segment limit or was non-canonical.
			X	A null data segment was used to reference memory.
Page fault, #PF		X	X	A page fault resulted from the execution of the instruction.
Alignment check, #AC		X	X	An unaligned memory reference was performed while alignment checking was enabled.

JMP (Far) Far Jump

Unconditionally transfers control to a new address without saving the current CS:rIP values. This form of the instruction jumps to an address outside the current code segment and is called a *far jump*. The operand specifies a target selector and offset.

The target operand can be specified by the instruction directly, by containing the far pointer in the `jmp far` opcode itself, or indirectly, by referencing a far pointer in memory. In 64-bit mode, only indirect far jumps are allowed, executing a direct far `jmp` (opcode `EA`) will generate an undefined opcode exception.

In all modes, the target selector used by the instruction can be a code selector. Additionally, the target selector can also be a call gate in protected mode, or a task gate or TSS selector in legacy protected mode.

- *Target is a code segment*—Control is transferred to the target CS:rIP. In this case, the target offset can only be a 16 or 32 bit value, depending on operand-size, and is zero-extended to 64 bits. No CPL change is allowed.
- *Target is a call gate*—The call gate specifies the actual target code segment and offset, and control is transferred to the target CS:rIP. When jumping through a call gate, the size of the target rIP is 16, 32, or 64 bits, depending on the size of the call gate. If the target rIP is less than 64 bits, it's zero-extended to 64 bits. In long mode, only 64-bit call gates are allowed, and they must point to 64-bit code segments. No CPL change is allowed.
- *Target is a task gate or a TSS*—If the mode is legacy protected mode, then a task switch occurs. See “Hardware Task-Management in Legacy Mode” in volume 2 for details about task switches. Hardware task switches are not supported in long mode.

See `JMP (Near)` for information on near jumps—jumps to procedures located inside the current code segment. For details about control-flow instructions, see “Control Transfers” in Volume 1, and “Control-Transfer Privilege Checks” in Volume 2.

Mnemonic	Opcode	Description
<code>JMP FAR <i>pntr</i>16:16</code>	<code>EA <i>cd</i></code>	Far jump direct, with the target specified by a far pointer contained in the instruction. (Invalid in 64-bit mode.)
<code>JMP FAR <i>pntr</i>16:32</code>	<code>EA <i>cp</i></code>	Far jump direct, with the target specified by a far pointer contained in the instruction. (Invalid in 64-bit mode.)

Mnemonic	Opcode	Description
JMP FAR <i>mem16:16</i>	FF/5	Far jump indirect, with the target specified by a far pointer in memory.
JMP FAR <i>mem16:32</i>	FF/5	Far jump indirect, with the target specified by a far pointer in memory.

Action

// Far jumps (JMPF)
 // See "Pseudocode Definitions" on page 49.

JMPF_START:

```
IF (REAL_MODE)
    JMPF_REAL_OR_VIRTUAL
ELIF (PROTECTED_MODE)
    JMPF_PROTECTED
ELSE // (VIRTUAL_MODE)
    JMPF_REAL_OR_VIRTUAL
```

JMPF_REAL_OR_VIRTUAL:

```
IF (OPCODE = jmpf [mem]) //JMPF Indirect
{
    temp_RIP = READ_MEM.z [mem]
    temp_CS = READ_MEM.w [mem+Z]
}
ELSE // (OPCODE = jmpf direct)
{
    temp_RIP = z-sized offset specified in the instruction,
                zero-extended to 64 bits
    temp_CS = selector specified in the instruction
}

IF (temp_RIP>CS.limit)
    EXCEPTION [#GP(0)]

CS.sel = temp_CS
CS.base = temp_CS SHL 4
RIP = temp_RIP
EXIT
```

JMPF_PROTECTED:

```
IF (OPCODE = jmpf [mem]) // JMPF Indirect
{
    temp_offset = READ_MEM.z [mem]
    temp_sel = READ_MEM.w [mem+Z]
```



```

}
ELSE // (OPCODE = jmpf direct)
{
    IF (64BIT_MODE)
        EXCEPTION [#UD]           // 'jmpf direct' is illegal in 64-bit mode

    temp_offset = z-sized offset specified in the instruction,
                zero-extended to 64 bits
    temp_sel     = selector specified in the instruction
}

temp_desc = READ_DESCRIPTOR (temp_sel, cs_chk)
           // read descriptor, perform protection and type checks

IF (temp_desc.attr.type = 'available_tss')
    TASK_SWITCH // using temp_sel as the target tss selector
ELIF (temp_desc.attr.type = 'taskgate')
    TASK_SWITCH // using the tss selector in the task gate as the
              // target tss
ELIF (temp_desc.attr.type = 'code')
    // if the selector refers to a code descriptor, then
    // the offset we read is the target RIP
{
    temp_RIP = temp_offset
    CS = temp_desc
    IF ((!64BIT_MODE) && (temp_RIP > CS.limit))
        // temp_RIP can't be non-canonical because
        // it's a 16- or 32-bit offset, zero-extended to 64 bits
    {
        EXCEPTION [#GP(0)]
    }
    RIP = temp_RIP
    EXIT
}
ELSE
{
    // (temp_desc.attr.type = 'callgate')
    // if the selector refers to a call gate, then
    // the target CS and RIP both come from the call gate
    temp_RIP = temp_desc.offset

    IF (LONG_MODE)
    {
        // in long mode, we need to read the 2nd half of a 16-byte call-gate
        // from the gdt/ldt to get the upper 32 bits of the target RIP
        temp_upper = READ_MEM.q [temp_sel+8]
        IF (temp_upper's extended attribute bits != 0)
            EXCEPTION [#GP(temp_sel)] // Make sure the extended
                                      // attribute bits are all zero.

        temp_RIP = tempRIP + (temp_upper SHL 32)
    }
}

```

```

        // concatenate both halves of RIP
    }
    CS = READ_DESCRIPTOR (temp_desc.segment, clg_chk)
        // set up new CS base, attr, limits
    IF ((64BIT_MODE) && (temp_RIP is non-canonical)
        || (!64BIT_MODE) && (temp_RIP > CS.limit))
        EXCEPTION [#GP(0)]
    RIP = temp_RIP
    EXIT
}

```

Related Instructions

JMP (Near), Jcc, JrCX

rFLAGS Affected

None, unless a task switch occurs, in which case all flags are modified.

Exceptions

Exception	Real	Virtual 8086	Protected	Cause of Exception
Invalid opcode, #UD	X	X	X	The far JUMP indirect opcode (FF /5) had a register operand.
			X	The far JUMP direct opcode (EA) was executed in 64-bit mode.
Segment not present, #NP (selector)			X	The accessed code segment, call gate, task gate, or TSS was not present.
Stack, #SS	X	X	X	A memory address exceeded the stack segment limit or was non-canonical.
General protection, #GP	X	X	X	A memory address exceeded a data segment limit or was non-canonical.
			X	The target offset exceeded the code segment limit or was non-canonical.
			X	A null data segment was used to reference memory.

Exception	Real	Virtual 8086	Protected	Cause of Exception
General protection, #GP (selector)			X	The target code segment selector was a null selector.
			X	A code, call gate, task gate, or TSS descriptor exceeded the descriptor table limit.
			X	A segment selector's TI bit was set, but the LDT selector was a null selector.
			X	The segment descriptor specified by the instruction was not a code segment, task gate, call gate or available TSS in legacy mode, or not a 64-bit code segment or a 64-bit call gate in long mode.
			X	The RPL of the non-conforming code segment selector specified by the instruction was greater than the CPL, or its DPL was not equal to the CPL.
			X	The DPL of the conforming code segment descriptor specified by the instruction was greater than the CPL.
			X	The DPL of the callgate, taskgate, or TSS descriptor specified by the instruction was less than the CPL or less than its own RPL.
			X	The segment selector specified by the call gate or task gate was a null selector.
			X	The segment descriptor specified by the call gate was not a code segment in legacy mode or not a 64-bit code segment in long mode.
			X	The DPL of the segment descriptor specified the call gate was greater than the CPL and it is a conforming segment.
			X	The DPL of the segment descriptor specified by the callgate was not equal to the CPL and it is a non-conforming segment.
			X	The 64-bit call gate's extended attribute bits were not zero.
		X	The TSS descriptor was found in the LDT.	
Page fault, #PF		X	X	A page fault resulted from the execution of the instruction.
Alignment check, #AC		X	X	An unaligned memory reference was performed while alignment checking was enabled.

LAHF Load Status Flags into AH Register

Loads the lower 8 bits of the rFLAGS register, including sign flag (SF), zero flag (ZF), auxiliary carry flag (AF), parity flag (PF), and carry flag (CF), into the AH register.

The instruction sets the reserved bits 1, 3, and 5 of the rFLAGS register to 1, 0, and 0, respectively, in the AH register.

Mnemonic	Opcode	Description
LAHF	9F	Load the SF, ZF, AF, PF, and CF flags into the AH register.

Related Instructions

SAHF

rFLAGS Affected

Exceptions

None

LDS

LES

LFS

LGS

LSS

Load Far Pointer

Loads a far pointer from a memory location (second operand) into a segment register (mnemonic) and general-purpose register (first operand). The instruction stores the 16-bit segment selector of the pointer into the segment register and the 16-bit or 32-bit offset portion into the general-purpose register. The operand-size attribute determines whether the pointer is 32-bit or 48-bit.

These instructions load associated segment-descriptor information into the hidden portion of the specified segment register.

Using LDS or LES in 64-bit mode generates an invalid-opcode exception.

Executing LFS, LGS, or LSS with a 64-bit operand size only loads a 32-bit general purpose register and the specified segment register.

Mnemonic	Opcode	Description
LDS <i>reg16, mem16:16</i>	C5 /r	Load DS:reg16 with a far pointer from memory. (Invalid in 64-bit mode.)
LDS <i>reg32, mem16:32</i>	C5 /r	Load DS:reg32 with a far pointer from memory. (Invalid in 64-bit mode.)
LES <i>reg16, mem16:16</i>	C4 /r	Load ES:reg16 with a far pointer from memory. (Invalid in 64-bit mode.)
LES <i>reg32, mem16:32</i>	C4 /r	Load ES:reg32 with a far pointer from memory. (Invalid in 64-bit mode.)
LFS <i>reg16, mem16:16</i>	0F B4 /r	Load FS:reg16 with a far pointer from memory.
LFS <i>reg32, mem16:32</i>	0F B4 /r	Load FS:reg32 with a far pointer from memory.
LGS <i>reg16, mem16:16</i>	0F B5 /r	Load GS:reg16 with a far pointer from memory.
LGS <i>reg32, mem16:32</i>	0F B5 /r	Load GS:reg32 with a far pointer from memory.
LSS <i>reg16, mem16:16</i>	0F B2 /r	Load SS:reg16 with a far pointer from memory.
LSS <i>reg32, mem16:32</i>	0F B2 /r	Load SS:reg32 with a far pointer from memory.

Related Instructions

None

rFLAGS Affected

None

Exceptions

Exception	Real	Virtual 8086	Protected	Cause of Exception
Invalid opcode, #UD	X	X	X	The source operand was a register.
			X	LDS or LES was executed in 64-bit mode.
Segment not present, #NP (selector)			X	The DS, ES, FS, or GS register was loaded with a non-null segment selector and the segment was marked not present.
Stack, #SS	X	X	X	A memory address exceeded the stack segment limit or was non-canonical.
Stack, #SS (selector)			X	The SS register was loaded with a non-null segment selector and the segment was marked not present.
General protection, #GP	X	X	X	A memory address exceeded a data segment limit or was non-canonical.
			X	A null data segment was used to reference memory.
General protection, #GP (selector)			X	A segment register was loaded, but the segment descriptor exceeded the descriptor table limit.
			X	A segment register was loaded and the segment selector's TI bit was set, but the LDT selector was a null selector.
			X	The SS register was loaded with a null segment selector in non-64-bit mode or while CPL = 3.
			X	The SS register was loaded and the segment selector RPL and the segment descriptor DPL were not equal to the CPL.
			X	The SS register was loaded and the segment pointed to was not a writable data segment.
			X	The DS, ES, FS, or GS register was loaded and the segment pointed to was a data or non-conforming code segment, but the RPL or CPL was greater than the DPL.
			X	The DS, ES, FS, or GS register was loaded and the segment pointed to was not a data segment or readable code segment.

Exception	Real	Virtual 8086	Protected	Cause of Exception
Page fault, #PF		X	X	A page fault resulted from the execution of the instruction.
Alignment check, #AC		X	X	An unaligned memory reference was performed while alignment checking was enabled.

LEA Load Effective Address

Computes the effective address of a memory location (second operand) and stores it in a general-purpose register (first operand).

The address size of the memory location and the size of the register determine the specific action taken by the instruction, as follows:

- If the address size and the register size are the same, the instruction stores the effective address as computed.
- If the address size is longer than the register size, the instruction truncates the effective address to the size of the register.
- If the address size is shorter than the register size, the instruction zero-extends the effective address to the size of the register.

If the second operand is a register, an undefined-opcode exception occurs.

The LEA instruction is related to the MOV instruction, which copies data from a memory location to a register, but LEA takes the address of the source operand, whereas MOV takes the contents of the memory location specified by the source operand. In the simplest cases, LEA can be replaced with MOV. For example:

```
lea eax, [ebx]
```

has the same effect as:

```
mov eax, ebx
```

However, LEA allows software to use any valid ModRM and SIB addressing mode for the source operand. For example:

```
lea eax, [ebx+edi]
```

loads the sum of the EBX and EDI registers into the EAX register. This could not be accomplished by a single MOV instruction.

The LEA instruction has a limited capability to perform multiplication of operands in general-purpose registers using scaled-index addressing. For example:

```
lea eax, [ebx+ebx*8]
```

loads the value of the EBX register, multiplied by 9, into the EAX register. Possible values of multipliers are 2, 4, 8, 3, 5, and 9.

The LEA instruction is widely used in string-processing and array-processing to initialize an index register (rSI or rDI) before performing string instructions such as

MOVSx. It is also used to initialize the rBX register before performing the XLAT instruction in programs that perform character translations. In data structures, the LEA instruction can calculate addresses of operands stored in memory, and in particular, addresses of array or string elements.

Mnemonic	Opcode	Description
LEA <i>reg16, mem</i>	8D /r	Store effective address in a 16-bit register.
LEA <i>reg32, mem</i>	8D /r	Store effective address in a 32-bit register.
LEA <i>reg64, mem</i>	8D /r	Store effective address in a 64-bit register.

Related Instructions

MOV

rFLAGS Affected

None

Exceptions

Exception	Real	Virtual 8086	Protected	Cause of Exception
Invalid opcode, #UD	X	X	X	The source operand was a register.

LEAVE**Delete Procedure Stack Frame**

Releases a stack frame created by a previous ENTER instruction. To release the frame, it copies the frame pointer (in the rBP register) to the stack pointer register (rSP), and then pops the old frame pointer from the stack into the rBP register, thus restoring the stack frame of the calling procedure.

The 32-bit LEAVE instruction is equivalent to the following 32-bit operation:

```
MOV ESP,EBP
POP EBP
```

To return program control to the calling procedure, execute a RET instruction after the LEAVE instruction.

In 64-bit mode, the LEAVE operand size defaults to 64 bits, and there is no prefix available for encoding a 32-bit operand size.

Mnemonic	Opcode	Description
LEAVE	C9	Set the stack pointer register SP to the value in the BP register and pop BP.
LEAVE	C9	Set the stack pointer register ESP to the value in the EBP register and pop EBP. (No prefix for encoding this in 64-bit mode.)
LEAVE	C9	Set the stack pointer register RSP to the value in the RBP register and pop RBP.

Related Instructions

ENTER

rFLAGS Affected

None

Exceptions

Exception	Real	Virtual 8086	Protected	Cause of Exception
Stack, #SS	X	X	X	A memory address exceeded the stack segment limit or was non-canonical.
Page fault, #PF		X	X	A page fault resulted from the execution of the instruction.
Alignment check, #AC		X	X	An unaligned memory reference was performed while alignment checking was enabled.

LFENCE Load Fence

Acts as a barrier to force strong memory ordering (serialization) between load instructions preceding the LFENCE and load instructions that follow the LFENCE. A weakly-ordered memory system allows hardware to reorder reads and writes between the processor and memory. The LFENCE instruction guarantees that the system completes all previous loads before executing subsequent loads.

The LFENCE instruction is weakly-ordered with respect to store instructions, data and instruction prefetches, and the SFENCE instruction. Speculative loads initiated by the processor, or specified explicitly using cache-prefetch instructions, can be reordered around an LFENCE.

In addition to load instructions, the LFENCE instruction is strongly ordered with respect to other LFENCE instructions, MFENCE instructions, and serializing instructions.

Support for the LFENCE instruction is indicated when the SSE2 bit (bit 26) is set to 1 in EDX after executing CPUID standard function 1.

Mnemonic	Opcode	Description
LFENCE	OF AE E8	Force strong ordering of (serialize) load operations.

Related Instructions

MFENCE, SFENCE

rFLAGS Affected

None

Exceptions

Exception	Real	Virtual 8086	Protected	Cause of Exception
Invalid opcode, #UD	X	X	X	The LFENCE instruction is not supported as indicated by bit 26 of CPUID standard function 1.

LODS Load String

LODSB

LODSW

LODSD

LODSQ

Copies the byte, word, doubleword, or quadword in the memory location pointed to by the DS:rSI registers to the AL, AX, EAX, or RAX register, depending on the size of the operand, and then increments or decrements the rSI register according to the state of the DF flag in the rFLAGS register.

If the DF flag is 0, the instruction increments rSI; otherwise, it decrements rSI. It increments or decrements rSI by 1, 2, 4, or 8, depending on the number of bytes being loaded.

The forms of the LODS instruction with an explicit operand address the operand at *seg*:rSI]. The value of *seg* defaults to the DS segment, but may be overridden by a segment prefix. The explicit operand serves only to specify the type (size) of the value being copied and the specific registers used.

The no-operands forms of the instruction always use the DS:[rSI] registers to point to the value to be copied (they do not allow a segment prefix). The mnemonic determines the size of the operand and the specific registers used.

The LODSx instructions support the REP prefixes. For details about the REP prefixes, see “Repeat Prefixes” on page 10. More often, software uses the LODSx instruction inside a loop controlled by a LOOPcc instruction as a more efficient replacement for instructions like:

```
mov eax, dword ptr ds:[esi]
add esi, 4
```

The LODSQ instruction can only be used in 64-bit mode.

Mnemonic	Opcode	Description
LODS <i>mem8</i>	AC	Load byte at DS:rSI into AL and then increment or decrement rSI.
LODS <i>mem16</i>	AD	Load word at DS:rSI into AX and then increment or decrement rSI.
LODS <i>mem32</i>	AD	Load doubleword at DS:rSI into EAX and then increment or decrement rSI.

Mnemonic	Opcode	Description
LODS <i>mem64</i>	AD	Load quadword at DS:rSI into RAX and then increment or decrement rSI.
LODSB	AC	Load byte at DS:rSI into AL and then increment or decrement rSI.
LODSW	AD	Load the word at DS:rSI into AX and then increment or decrement rSI.
LODSD	AD	Load doubleword at DS:rSI into EAX and then increment or decrement rSI.
LODSQ	AD	Load quadword at DS:rSI into RAX and then increment or decrement rSI.

Related Instructions

MOV s x, STOS s x

rFLAGS Affected

None

Exceptions

Exception	Real	Virtual 8086	Protected	Cause of Exception
Stack, #SS	X	X	X	A memory address exceeded the stack segment limit or was non-canonical.
General protection, #GP	X	X	X	A memory address exceeded a data segment limit or was non-canonical.
			X	A null data segment was used to reference memory.
Page fault, #PF		X	X	A page fault resulted from the execution of the instruction.
Alignment check, #AC		X	X	An unaligned memory reference was performed while alignment checking was enabled.

LOOP **Loop**

LOOPE

LOOPNE

LOOPNZ

LOOPZ

Decrements the count register (rCX) by 1, then, if rCX is not 0 and the ZF flag meets the condition specified by the mnemonic, it jumps to the target instruction specified by the signed 8-bit relative offset. Otherwise, it continues with the next instruction after the LOOPcc instruction.

The size of the count register used (CX, ECX, or RCX) depends on the address-size attribute of the LOOPcc instruction.

The LOOP instruction ignores the state of the ZF flag.

The LOOPE and LOOPZ instructions jump if rCX is not 0 and the ZF flag is set to 1. In other words, the instruction exits the loop (falls through to the next instruction) if rCX becomes 0 or ZF = 0.

The LOOPNE and LOOPNZ instructions jump if rCX is not 0 and ZF flag is cleared to 0. In other words, the instruction exits the loop if rCX becomes 0 or ZF = 1.

The LOOPcc instruction does not change the state of the ZF flag. Typically, the loop contains a compare instruction to set or clear the ZF flag.

If the jump is taken, the signed displacement is added to the rIP (of the following instruction) and the result is truncated to 16, 32, or 64 bits, depending on operand size.

In 64-bit mode, the operand size defaults to 64 bits without the need for a REX prefix, and the processor sign-extends the 8-bit offset before adding it to the RIP.

Mnemonic	Opcode	Description
LOOP <i>rel8off</i>	E2 <i>cb</i>	Decrement rCX, then jump short if rCX is not 0.
LOOPE <i>rel8off</i>	E1 <i>cb</i>	Decrement rCX, then jump short if rCX is not 0 and ZF is 1.
LOOPNE <i>rel8off</i>	E0 <i>cb</i>	Decrement rCX, then Jump short if rCX is not 0 and ZF is 0.

Mnemonic	Opcode	Description
LOOPNZ <i>rel8off</i>	E0 <i>cb</i>	Decrement rCX, then Jump short if rCX is not 0 and ZF is 0.
LOOPZ <i>rel8off</i>	E1 <i>cb</i>	Decrement rCX, then Jump short if rCX is not 0 and ZF is 1.

Related Instructions

None

rFLAGS Affected

None

Exceptions

Exception	Real	Virtual 8086	Protected	Cause of Exception
General protection, #GP	X	X	X	The target offset exceeded the code segment limit or was non-canonical.

MFENCE Memory Fence

Acts as a barrier to force strong memory ordering (serialization) between load and store instructions preceding the MFENCE, and load and store instructions that follow the MFENCE. A weakly-ordered memory system allows the hardware to reorder reads and writes between the processor and memory. The MFENCE instruction guarantees that the system completes all previous memory accesses before executing subsequent accesses.

The MFENCE instruction is weakly-ordered with respect to data and instruction prefetches. Speculative loads initiated by the processor, or specified explicitly using cache-prefetch instructions, can be reordered around an MFENCE.

In addition to load and store instructions, the MFENCE instruction is strongly ordered with respect to other MFENCE instructions, LFENCE instructions, SFENCE instructions, serializing instructions, and CLFLUSH instructions.

Support for the MFENCE instruction is indicated when the SSE2 bit (bit 26) is set to 1 in EDX after executing CPUID with standard function 1.

Mnemonic	Opcode	Description
MFENCE	0F AE F0	Force strong ordering of (serialized) load and store operations.

Related Instructions

LFENCE, SFENCE

rFLAGS Affected

None

Exceptions

Exception	Real	Virtual 8086	Protected	Cause of Exception
Invalid opcode, #UD	X	X	X	The MFENCE instruction is not supported as indicated by bit 26 of CPUID standard function 1.

MOV

Move

Copies an immediate value or the value in a general-purpose register, segment register, or memory location (second operand) to a general-purpose register, segment register, or memory location. The source and destination must be the same size (byte, word, doubleword, or quadword) and cannot both be memory locations.

In opcodes A0 through A3, the memory offsets (called *moffsets*) are address sized. In 64-bit mode, memory offsets default to 64 bits. Opcodes A0–A3, in 64-bit mode, are the only cases that support a 64-bit offset value. (In all other cases, offsets and displacements are a maximum of 32 bits.) The B8 through BF (B8 +*rq*) opcodes, in 64-bit mode, are the only cases that support a 64-bit immediate value (in all other cases, immediate values are a maximum of 32 bits).

When reading segment-registers with a 32-bit operand size, the processor zero-extends the 16-bit selector results to 32 bits. When reading segment-registers with a 64-bit operand size, the processor zero-extends the 16-bit selector to 64 bits. If the destination operand specifies a segment register (DS, ES, FS, GS, or SS), the source operand must be a valid segment selector.

It is possible to move a null segment selector value (0000–0003h) into the DS, ES, FS, or GS register. This action does not cause a general protection fault, but a subsequent reference to such a segment *does* cause a #GP exception. For more information about segment selectors, see “Segment Selectors and Registers” on page 84.

When the MOV instruction is used to load the SS register, the processor blocks external interrupts until after the execution of the following instruction. This action allows the following instruction to be a MOV instruction to load a stack pointer into the ESP register (MOV ESP, val) before an interrupt occurs. However, the LSS instruction provides a more efficient method of loading SS and ESP.

Attempting to use the MOV instruction to load the CS register generates an invalid opcode exception (#UD). Use the far JMP, CALL, or RET instructions to load the CS register.

To initialize a register to 0, rather than using a MOV instruction, it may be more efficient to use the XOR instruction with identical destination and source operands.

Mnemonic	Opcode	Description
MOV <i>reg/mem8, reg8</i>	88 /r	Move the contents of an 8-bit register to an 8-bit destination register or memory operand.
MOV <i>reg/mem16, reg16</i>	89 /r	Move the contents of a 16-bit register to a 16-bit destination register or memory operand.
MOV <i>reg/mem32, reg32</i>	89 /r	Move the contents of a 32-bit register to a 32-bit destination register or memory operand.
MOV <i>reg/mem64, reg64</i>	89 /r	Move the contents of a 64-bit register to a 64-bit destination register or memory operand.
MOV <i>reg8, reg/mem8</i>	8A /r	Move the contents of an 8-bit register or memory operand to an 8-bit destination register.
MOV <i>reg16, reg/mem16</i>	8B /r	Move the contents of a 16-bit register or memory operand to a 16-bit destination register.
MOV <i>reg32, reg/mem32</i>	8B /r	Move the contents of a 32-bit register or memory operand to a 32-bit destination register.
MOV <i>reg64, reg/mem64</i>	8B /r	Move the contents of a 64-bit register or memory operand to a 64-bit destination register.
MOV <i>reg16/32/64/mem16, segReg</i>	8C /r	Move the contents of a segment register to a 16-bit, 32-bit, or 64-bit destination register or to a 16-bit memory operand.
MOV <i>segReg, reg/mem16</i>	8E /r	Move the contents of a 16-bit register or memory operand to a segment register.
MOV AL, <i>moffset8</i>	A0	Move 8-bit data at a specified memory offset to the AL register.
MOV AX, <i>moffset16</i>	A1	Move 16-bit data at a specified memory offset to the AX register.
MOV EAX, <i>moffset32</i>	A1	Move 32-bit data at a specified memory offset to the EAX register.
MOV RAX, <i>moffset64</i>	A1	Move 64-bit data at a specified memory offset to the RAX register.
MOV <i>moffset8, AL</i>	A2	Move the contents of the AL register to an 8-bit memory offset.
MOV <i>moffset16, AX</i>	A3	Move the contents of the AX register to a 16-bit memory offset.
MOV <i>moffset32, EAX</i>	A3	Move the contents of the EAX register to a 32-bit memory offset.
MOV <i>moffset64, RAX</i>	A3	Move the contents of the RAX register to a 64-bit memory offset.
MOV <i>reg8, imm8</i>	B0 +rb	Move an 8-bit immediate value into an 8-bit register.
MOV <i>reg16, imm16</i>	B8 +rw	Move a 16-bit immediate value into a 16-bit register.
MOV <i>reg32, imm32</i>	B8 +rd	Move an 32-bit immediate value into a 32-bit register.

Mnemonic	Opcode	Description
MOV <i>reg64, imm64</i>	B8 + <i>rq</i>	Move an 64-bit immediate value into a 64-bit register.
MOV <i>reg/mem8, imm8</i>	C6 /0	Move an 8-bit immediate value to an 8-bit register or memory operand.
MOV <i>reg/mem16, imm16</i>	C7 /0	Move a 16-bit immediate value to a 16-bit register or memory operand.
MOV <i>reg/mem32, imm32</i>	C7 /0	Move a 32-bit immediate value to a 32-bit register or memory operand.
MOV <i>reg/mem64, imm32</i>	C7 /0	Move a 32-bit signed immediate value to a 64-bit register or memory operand.

Related Instructions

MOV(*CR_n*), MOV(*DR_n*), MOVD, MOVSX, MOVZX, MOVXSD, MOV_{Sx}

rFLAGS Affected

None

Exceptions

Exception	Real	Virtual 8086	Protected	Cause of Exception
Invalid opcode, #UD	X	X	X	An attempt was made to load the CS register.
Segment not present, #NP (selector)			X	The DS, ES, FS, or GS register was loaded with a non-null segment selector and the segment was marked not present.
Stack, #SS	X	X	X	A memory address exceeded the stack segment limit or was non-canonical.
Stack, #SS (selector)			X	The SS register was loaded with a non-null segment selector, and the segment was marked not present.
General protection, #GP	X	X	X	A memory address exceeded a data segment limit or was non-canonical.
			X	The destination operand was in a non-writable segment.
			X	A null data segment was used to reference memory.

Exception	Real	Virtual 8086	Protected	Cause of Exception
General protection, #GP (selector)			X	A segment register was loaded, but the segment descriptor exceeded the descriptor table limit.
			X	A segment register was loaded and the segment selector's TI bit was set, but the LDT selector was a null selector.
			X	The SS register was loaded with a null segment selector in non-64-bit mode or while CPL = 3.
			X	The SS register was loaded and the segment selector RPL and the segment descriptor DPL were not equal to the CPL.
			X	The SS register was loaded and the segment pointed to was not a writable data segment.
			X	The DS, ES, FS, or GS register was loaded and the segment pointed to was a data or non-conforming code segment, but the RPL or CPL was greater than the DPL.
		X	X	The DS, ES, FS, or GS register was loaded and the segment pointed to was not a data segment or readable code segment.
Page fault, #PF		X	X	A page fault resulted from the execution of the instruction.
Alignment check, #AC		X	X	An unaligned memory reference was performed while alignment checking was enabled.

MOVD**Move Doubleword or Quadword**

Moves a 32-bit or 64-bit value in one of the following ways:

- from a 32-bit or 64-bit general-purpose register or memory location to the low-order 32 or 64 bits of an XMM register, with zero-extension to 128 bits
- from the low-order 32 or 64 bits of an XMM to a 32-bit or 64-bit general-purpose register or memory location
- from a 32-bit or 64-bit general-purpose register or memory location to the low-order 32 bits (with zero-extension to 64 bits) or the full 64 bits of an MMX register
- from the low-order 32 or the full 64 bits of an MMX register to a 32-bit or 64-bit general-purpose register or memory location

Mnemonic	Opcode	Description
<code>MOVD <i>xmm</i>, <i>reg/mem32</i></code>	66 0F 6E/r	Move 32-bit value from a general-purpose register or 32-bit memory location to an XMM register.
<code>MOVD <i>xmm</i>, <i>reg/mem64</i></code>	66 0F 6E/r	Move 64-bit value from a general-purpose register or 64-bit memory location to an XMM register.
<code>MOVD <i>reg/mem32</i>, <i>xmm</i></code>	66 0F 7E/r	Move 32-bit value from an XMM register to a 32-bit general-purpose register or memory location.
<code>MOVD <i>reg/mem64</i>, <i>xmm</i></code>	66 0F 7E/r	Move 64-bit value from an XMM register to a 64-bit general-purpose register or memory location.
<code>MOVD <i>mmx</i>, <i>reg/mem32</i></code>	0F 6E/r	Move 32-bit value from a general-purpose register or 32-bit memory location to an MMX register.
<code>MOVD <i>mmx</i>, <i>reg/mem64</i></code>	0F 6E/r	Move 64-bit value from a general-purpose register or 64-bit memory location to an MMX register.
<code>MOVD <i>reg/mem32</i>, <i>mmx</i></code>	0F 7E/r	Move 32-bit value from an MMX register to a 32-bit general-purpose register or memory location.
<code>MOVD <i>reg/mem64</i>, <i>mmx</i></code>	0F 7E/r	Move 64-bit value from an MMX register to a 64-bit general-purpose register or memory location.

The diagrams in Figure 3-4 on page 193 illustrate the operation of the MOVD instruction.

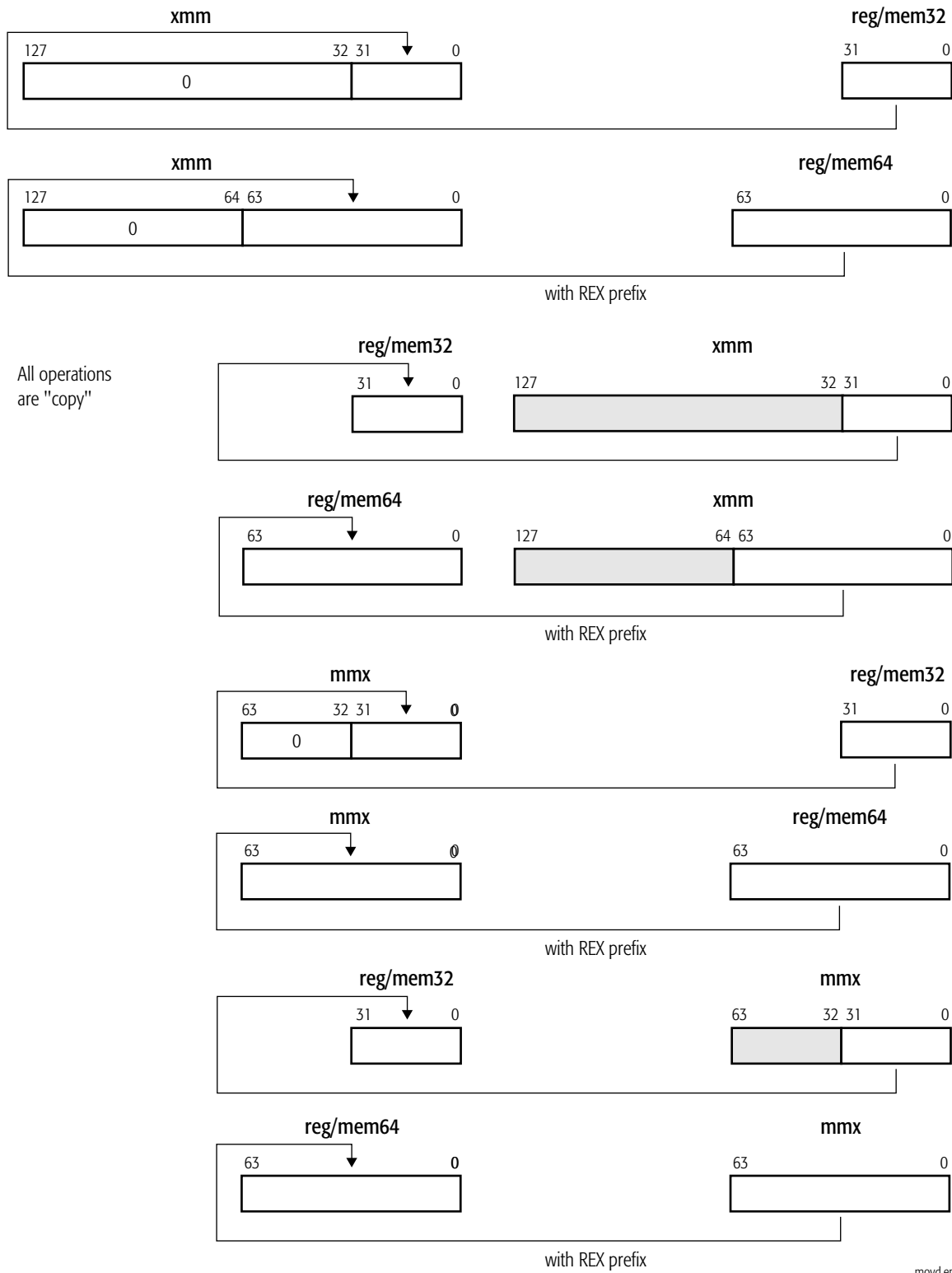

Figure 3-4. MOVQ Instruction Operation

Related Instructions

MOVDQA, MOVDQU, MOVDQ2Q, MOVQ, MOVQ2DQ

rFLAGS Affected

None

MXCSR Flags Affected

None

Exceptions (All Modes)

Exception	Real	Virtual 8086	Protected	Description
Invalid opcode, #UD	X	X	X	The MMX instructions are not supported, as indicated by bit 23 of CPUID standard function 1.
	X	X	X	The SSE2 instructions are not supported, as indicated by bit 26 of CPUID standard function 1.
	X	X	X	The emulate bit (EM) of CR0 was set to 1.
	X	X	X	The instruction used XMM registers while CR4.OSFXSR=0.
Device not available, #NM	X	X	X	The task-switch bit (TS) of CR0 was set to 1.
Stack, #SS	X	X	X	A memory address exceeded the stack segment limit or was non-canonical.
General protection, #GP	X	X	X	A memory address exceeded a data segment limit or was non-canonical.
Page fault, #PF		X	X	A page fault resulted from the execution of the instruction.
x87 floating-point exception pending, #MF	X	X	X	An x87 floating-point exception was pending and the instruction referenced an MMX register.
Alignment check, #AC		X	X	An unaligned memory reference was performed while alignment checking was enabled.

MOVMSKPD Extract Packed Double-Precision Floating-Point Sign Mask

Moves the sign bits of two packed double-precision floating-point values in an XMM register (second operand) to the two low-order bits of a general-purpose register (first operand) with zero-extension.

Mnemonic	Opcode	Description
MOVMSKPD <i>reg32, xmm</i>	66 0F 50 /r	Move sign bits 127 and 63 in an XMM register to a 32-bit general-purpose register.

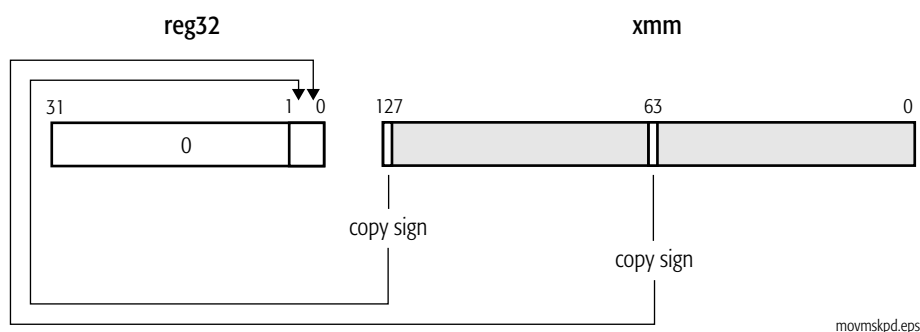

Related Instructions

MOVMSKPS, PMOVMSKB

rFLAGS Affected

None

MXCSR Flags Affected

None

Exceptions

Exception (vector)	Real	Virtual 8086	Protected	Cause of Exception
Invalid opcode, #UD	X	X	X	The SSE2 instructions are not supported, as indicated by bit 26 of CPUID standard function 1.
	X	X	X	The operating-system FXSAVE/FXRSTOR support bit (OSFXSR) of CR4 was cleared to 0.
	X	X	X	The emulate bit (EM) of CR0 was set to 1.
Device not available, #NM	X	X	X	The task-switch bit (TS) of CR0 was set to 1.

MOVMSKPS Extract Packed Single-Precision Floating-Point Sign Mask

Moves the sign bits of four packed single-precision floating-point values in an XMM register (second operand) to the four low-order bits of a general-purpose register (first operand) with zero-extension.

Mnemonic	Opcode	Description
MOVMSKPS <i>reg32, xmm</i>	0F 50 /r	Move sign bits 127, 95, 63, 31 in an XMM register to a 32-bit general-purpose register.

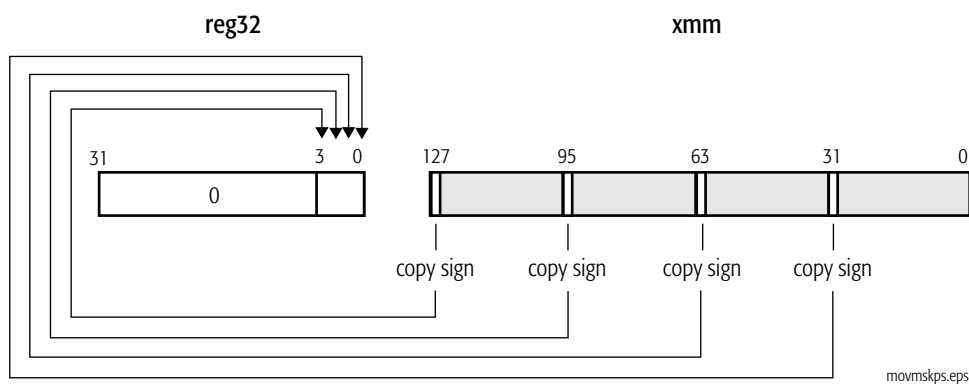

Related Instructions

MOVMSKPD, PMOVMSKB

rFLAGS Affected

None

MXCSR Flags Affected

None

Exceptions

Exception	Real	Virtual 8086	Protected	Cause of Exception
Invalid opcode, #UD	X	X	X	The SSE2 instructions are not supported, as indicated by bit 26 of CPUID extended function 1.
	X	X	X	The operating-system FXSAVE/FXRSTOR support bit (OSFXSR) of CR4 was cleared to 0.
	X	X	X	The emulate bit (EM) of CR0 was set to 1.
Device not available, #NM	X	X	X	The task-switch bit (TS) of CR0 was set to 1.

MOVNTI Move Non-Temporal Doubleword or Quadword

Stores a value in a 32-bit or 64-bit general-purpose register (second operand) in a memory location (first operand). This instruction indicates to the processor that the data is non-temporal and is unlikely to be used again soon. The processor treats the store as a write-combining (WC) memory write, which minimizes cache pollution. The exact method by which cache pollution is minimized depends on the hardware implementation of the instruction. For further information, see “Memory Optimization” in Volume 1.

The MOVNTI instruction is weakly-ordered with respect to other instructions that operate on memory. Software should use an SFENCE instruction to force strong memory ordering of MOVNTI with respect to other stores.

Support for the MOVNTI instruction is indicated when the SSE2 bit (bit 26) is set to 1 in EDX after executing CPUID standard function 1.

Mnemonic	Opcode	Description
MOVNTI <i>mem32, reg32</i>	0F C3 /r	Stores a 32-bit general-purpose register value into a 32-bit memory location, minimizing cache pollution.
MOVNTI <i>mem64, reg64</i>	0F C3 /r	Stores a 64-bit general-purpose register value into a 64-bit memory location, minimizing cache pollution.

Related Instructions

MOVNTDQ, MOVNTPD, MOVNTPS, MOVNTQ

rFLAGS Affected

None

Exceptions

Exception (vector)	Real	Virtual 8086	Protected	Cause of Exception
Invalid opcode, #UD	X	X	X	The SSE2 instructions are not supported, as indicated by bit 26 of CPUID standard function 1.
Stack, #SS	X	X	X	A memory address exceeded the stack segment limit or was non-canonical.

Exception (vector)	Real	Virtual 8086	Protected	Cause of Exception
General protection, #GP	X	X	X	A memory address exceeded a data segment limit or was non-canonical.
			X	A null data segment was used to reference memory.
			X	The destination operand was in a non-writable segment.
Page fault, #PF		X	X	A page fault resulted from the execution of the instruction.
Alignment check, #AC		X	X	An unaligned memory reference was performed while alignment checking was enabled.

MOVS Move String

MOVSB

MOVSW

MOVSD

MOVSQ

Moves a byte, word, doubleword, or quadword from the memory location pointed to by DS:rSI to the memory location pointed to by ES:rDI, and then increments or decrements the rSI and rDI registers according to the state of the DF flag in the rFLAGS register.

If the DF flag is 0, the instruction increments both pointers; otherwise, it decrements them. It increments or decrements the pointers by 1, 2, 4, or 8, depending on the size of the operands.

The forms of the MOV S_x instruction with explicit operands address the first operand at *seg*:rSI]. The value of *seg* defaults to the DS segment, but can be overridden by a segment prefix. These instructions always address the second operand at ES:[rDI] (ES may not be overridden). The explicit operands serve only to specify the type (size) of the value being moved.

The no-operands forms of the instruction use the DS:[rSI] and ES:[rDI] registers to point to the value to be moved (they do not allow a segment prefix). The mnemonic determines the size of the operands.

Do not confuse this MOVSD instruction with the same-mnemonic MOVSD (move scalar double-precision floating-point) instruction in the 128-bit media instruction set. Assemblers can distinguish the instructions by the number and type of operands.

The MOV S_x instructions support the REP prefixes. For details about the REP prefixes, see “Repeat Prefixes” on page 10.

Mnemonic	Opcode	Description
MOVS <i>mem8, mem8</i>	A4	Move byte at DS:rSI to ES:rDI, and then increment or decrement rSI and rDI.
MOVS <i>mem16, mem16</i>	A5	Move word at DS:rSI to ES:rDI, and then increment or decrement rSI and rDI.
MOVS <i>mem32, mem32</i>	A5	Move doubleword at DS:rSI to ES:rDI, and then increment or decrement rSI and rDI.

Mnemonic	Opcode	Description
MOVS <i>mem64, mem64</i>	A5	Move quadword at DS:rSI to ES:rDI, and then increment or decrement rSI and rDI.
MOVSB	A4	Move byte at DS:rSI to ES:rDI, and then increment or decrement rSI and rDI.
MOVSW	A5	Move word at DS:rSI to ES:rDI, and then increment or decrement rSI and rDI.
MOVSD	A5	Move doubleword at DS:rSI to ES:rDI, and then increment or decrement rSI and rDI.
MOVSQ	A5	Move quadword at DS:rSI to ES:rDI, and then increment or decrement rSI and rDI.

Related Instructions

MOV, LODS_x, STOS_x

rFLAGS Affected

None

Exceptions

Exception	Real	Virtual 8086	Protected	Cause of Exception
Stack, #SS	X	X	X	A memory address exceeded the stack segment limit or was non-canonical.
General protection, #GP	X	X	X	A memory address exceeded a data segment limit or was non-canonical.
			X	The destination operand was in a non-writable segment.
			X	A null data segment was used to reference memory.
Page fault, #PF		X	X	A page fault resulted from the execution of the instruction.
Alignment check, #AC		X	X	An unaligned memory reference was performed while alignment checking was enabled.

MOVSX Move with Sign-Extension

Copies the value in a register or memory location (second operand) into a register (first operand), extending the most significant bit of an 8-bit or 16-bit value into all higher bits in a 16-bit, 32-bit, or 64-bit register.

Mnemonic	Opcode	Description
MOVSX <i>reg16, reg/mem8</i>	0F BE /r	Move the contents of an 8-bit register or memory location to a 16-bit register with sign extension.
MOVSX <i>reg32, reg/mem8</i>	0F BE /r	Move the contents of an 8-bit register or memory location to a 32-bit register with sign extension.
MOVSX <i>reg64, reg/mem8</i>	0F BE /r	Move the contents of an 8-bit register or memory location to a 64-bit register with sign extension.
MOVSX <i>reg32, reg/mem16</i>	0F BF /r	Move the contents of an 16-bit register or memory location to a 32-bit register with sign extension.
MOVSX <i>reg64, reg/mem16</i>	0F BF /r	Move the contents of an 16-bit register or memory location to a 64-bit register with sign extension.

Related Instructions

MOVSXD, MOVZX

rFLAGS Affected

None

Exceptions

Exception	Real	Virtual 8086	Protected	Cause of Exception
Stack, #SS	X	X	X	A memory address exceeded the stack segment limit or was non-canonical.
General protection, #GP	X	X	X	A memory address exceeded a data segment limit or was non-canonical.
			X	A null data segment was used to reference memory.
Page fault, #PF		X	X	A page fault resulted from the execution of the instruction.
Alignment check, #AC		X	X	An unaligned memory reference was performed while alignment checking was enabled.

MOVSXD Move with Sign-Extend Doubleword

Copies the 32-bit value in a register or memory location (second operand) into a 64-bit register (first operand), extending the most significant bit of the 32-bit value into all higher bits of the 64-bit register.

This instruction requires the REX prefix 64-bit operand size bit (REX.W) to be set to 1 to sign-extend a 32-bit source operand to a 64-bit result. Without the REX operand-size prefix, the operand size will be 32 bits, the default for 64-bit mode, and the source is zero-extended into a 64-bit register. With a 16-bit operand size, only 16 bits are copied, without modifying the upper 48 bits in the destination.

This instruction is available only in 64-bit mode. In legacy or compatibility mode this opcode is interpreted as ARPL.

Mnemonic	Opcode	Description
MOVSXD <i>reg64, reg/mem32</i>	63 /r	Move the contents of a 32-bit register or memory operand to a 64-bit register with sign extension.

Related Instructions

MOVSX, MOVZX

rFLAGS Affected

None

Exceptions

Exception	Real	Virtual 8086	Protected	Cause of Exception
Stack, #SS			X	A memory address was non-canonical.
General protection, #GP			X	A memory address was non-canonical.
Page fault, #PF			X	A page fault resulted from the execution of the instruction.
Alignment check, #AC			X	An unaligned memory reference was performed while alignment checking was enabled.

MOVZX Move with Zero-Extension

Copies the value in a register or memory location (second operand) into a register (first operand), zero-extending the value to fit in the destination register. The operand-size attribute determines the size of the zero-extended value.

Mnemonic	Opcode	Description
MOVZX <i>reg16, reg/mem8</i>	0F B6 /r	Move the contents of an 8-bit register or memory operand to a 16-bit register with zero-extension.
MOVZX <i>reg32, reg/mem8</i>	0F B6 /r	Move the contents of an 8-bit register or memory operand to a 32-bit register with zero-extension.
MOVZX <i>reg64, reg/mem8</i>	0F B6 /r	Move the contents of an 8-bit register or memory operand to a 64-bit register with zero-extension.
MOVZX <i>reg32, reg/mem16</i>	0F B7 /r	Move the contents of a 16-bit register or memory operand to a 32-bit register with zero-extension.
MOVZX <i>reg64, reg/mem16</i>	0F B7 /r	Move the contents of a 16-bit register or memory operand to a 64-bit register with zero-extension.

Related Instructions

MOVSXD, MOVSX

rFLAGS Affected

None

Exceptions

Exception	Real	Virtual 8086	Protected	Cause of Exception
Stack, #SS	X	X	X	A memory address exceeded the stack segment limit or was non-canonical.
General protection, #GP	X	X	X	A memory address exceeded a data segment limit or was non-canonical.
			X	A null data segment was used to reference memory.
Page fault, #PF		X	X	A page fault resulted from the execution of the instruction.
Alignment check, #AC		X	X	An unaligned memory reference was performed while alignment checking was enabled.

MUL Unsigned Multiply

Multiplies the unsigned byte, word, doubleword, or quadword value in the specified register or memory location by the value in AL, AX, EAX, or RAX and stores the result in AX, DX:AX, EDX:EAX, or RDX:RAX (depending on the operand size). It puts the high-order bits of the product in AH, DX, EDX, or RDX.

If the upper half of the product is non-zero, the instruction sets the carry flag (CF) and overflow flag (OF) both to 1. Otherwise, it clears CF and OF to 0. The other arithmetic flags (SF, ZF, AF, PF) are undefined.

Mnemonic	Opcode	Description
MUL <i>reg/mem8</i>	F6 /4	Multiplies an 8-bit register or memory operand by the contents of the AL register and stores the result in the AX register.
MUL <i>reg/mem16</i>	F7 /4	Multiplies a 16-bit register or memory operand by the contents of the AX register and stores the result in the DX:AX register.
MUL <i>reg/mem32</i>	F7 /4	Multiplies a 32-bit register or memory operand by the contents of the EAX register and stores the result in the EDX:EAX register.
MUL <i>reg/mem64</i>	F7 /4	Multiplies a 64-bit register or memory operand by the contents of the RAX register and stores the result in the RDX:RAX register.

Related Instructions

DIV

rFLAGS Affected

ID	VIP	VIF	AC	VM	RF	NT	IOPL	OF	DF	IF	TF	SF	ZF	AF	PF	CF
								M				U	U	U	U	M
21	20	19	18	17	16	14	13–12	11	10	9	8	7	6	4	2	0

Note: Bits 31–22, 15, 5, 3, and 1 are reserved. A flag set to 1 or cleared to 0 is M (modified). Unaffected flags are blank. Undefined flags are U.

Exceptions

Exception	Real	Virtual 8086	Protected	Cause of Exception
Stack, #SS	X	X	X	A memory address exceeded the stack segment limit or was non-canonical.
General protection, #GP	X	X	X	A memory address exceeded a data segment limit or was non-canonical.
			X	A null data segment was used to reference memory.
Page fault, #PF		X	X	A page fault resulted from the execution of the instruction.
Alignment check, #AC		X	X	An unaligned memory reference is performed while alignment checking was enabled.

NEG Two's Complement Negation

Performs the two's complement negation of the value in the specified register or memory location by subtracting the value from 0. Use this instruction only on signed integer numbers.

If the value is 0, the instruction clears the CF flag to 0; otherwise, it sets CF to 1. The OF, SF, ZF, AF, and PF flag settings depend on the result of the operation.

The forms of the NEG instruction that write to memory support the LOCK prefix. For details about the LOCK prefix, see "Lock Prefix" on page 10.

Mnemonic	Opcode	Description
NEG <i>reg/mem8</i>	F6 /3	Performs a two's complement negation on an 8-bit register or memory operand.
NEG <i>reg/mem16</i>	F7 /3	Performs a two's complement negation on a 16-bit register or memory operand.
NEG <i>reg/mem32</i>	F7 /3	Performs a two's complement negation on a 32-bit register or memory operand.
NEG <i>reg/mem64</i>	F7 /3	Performs a two's complement negation on a 64-bit register or memory operand.

Related Instructions

AND, NOT, OR, XOR

rFLAGS Affected

ID	VIP	VIF	AC	VM	RF	NT	IOPL	OF	DF	IF	TF	SF	ZF	AF	PF	CF
								M				M	M	M	M	M
21	20	19	18	17	16	14	13–12	11	10	9	8	7	6	4	2	0

Note: Bits 31–22, 15, 5, 3, and 1 are reserved. A flag set to 1 or cleared to 0 is M (modified). Unaffected flags are blank. Undefined flags are U.

Exceptions

Exception	Real	Virtual 8086	Protected	Cause of Exception
Stack, #SS	X	X	X	A memory address exceeded the stack segment limit or was non-canonical.
General protection, #GP	X	X	X	A memory address exceeded a data segment limit or was non-canonical.
			X	The destination operand is in a non-writable segment.
			X	A null data segment was used to reference memory.
Page fault, #PF		X	X	A page fault resulted from the execution of the instruction.
Alignment check, #AC		X	X	An unaligned memory reference was performed while alignment checking was enabled.

NOP No Operation

Does nothing. This one-byte instruction increments the rIP to point to next instruction in the instruction stream, but does not affect the machine state in any other way.

The NOP instruction is an alias for `XCHG rAX, rAX`.

Mnemonic	Opcode	Description
NOP	90	Performs no operation.

Related Instructions

None

rFLAGS Affected

None

Exceptions

None

NOT One's Complement Negation

Performs the one's complement negation of the value in the specified register or memory location by inverting each bit of the value.

The memory-operand forms of the NOT instruction support the LOCK prefix. For details about the LOCK prefix, see "Lock Prefix" on page 10.

Mnemonic	Opcode	Description
NOT <i>reg/mem8</i>	F6 /2	Complements the bits in an 8-bit register or memory operand.
NOT <i>reg/mem16</i>	F7 /2	Complements the bits in a 16-bit register or memory operand.
NOT <i>reg/mem32</i>	F7 /2	Complements the bits in a 32-bit register or memory operand.
NOT <i>reg/mem64</i>	F7 /2	Complements the bits in a 64-bit register or memory operand.

Related Instructions

AND, NEG, OR, XOR

rFLAGS Affected

None

Exceptions

Exception	Real	Virtual 8086	Protected	Cause of Exception
Stack, #SS	X	X	X	A memory address exceeded the stack segment limit or was non-canonical.
General protection, #GP	X	X	X	The destination operand was in a non-writable segment.
			X	A null data segment was used to reference memory.
Page fault, #PF		X	X	A page fault resulted from the execution of the instruction.
Alignment check, #AC		X	X	An unaligned memory reference is performed while alignment checking was enabled.

OR Logical OR

Performs a logical OR on the bits in a register, memory location, or immediate value (second operand) and a register or memory location (first operand) and stores the result in the first operand location. The two operands cannot both be memory locations.

If both corresponding bits are 0, the corresponding bit of the result is 0; otherwise, the corresponding result bit is 1.

The forms of the OR instruction that write to memory support the LOCK prefix. For details about the LOCK prefix, see “Lock Prefix” on page 10.

Mnemonic	Opcode	Description
OR AL, <i>imm8</i>	0C <i>ib</i>	OR the contents of AL with an immediate 8-bit value.
OR AX, <i>imm16</i>	0D <i>iw</i>	OR the contents of AX with an immediate 16-bit value.
OR EAX, <i>imm32</i>	0D <i>id</i>	OR the contents of EAX with an immediate 32-bit value.
OR RAX, <i>imm32</i>	0D <i>id</i>	OR the contents of RAX with a sign-extended immediate 32-bit value.
OR <i>reg/mem8</i> , <i>imm8</i>	80 /1 <i>ib</i>	OR the contents of an 8-bit register or memory operand and an immediate 8-bit value.
OR <i>reg/mem16</i> , <i>imm16</i>	81 /1 <i>iw</i>	OR the contents of a 16-bit register or memory operand and an immediate 16-bit value.
OR <i>reg/mem32</i> , <i>imm32</i>	81 /1 <i>id</i>	OR the contents of a 32-bit register or memory operand and an immediate 32-bit value.
OR <i>reg/mem64</i> , <i>imm32</i>	81 /1 <i>id</i>	OR the contents of a 64-bit register or memory operand and sign-extended immediate 32-bit value.
OR <i>reg/mem16</i> , <i>imm8</i>	83 /1 <i>ib</i>	OR the contents of a 16-bit register or memory operand and a sign-extended immediate 8-bit value.
OR <i>reg/mem32</i> , <i>imm8</i>	83 /1 <i>ib</i>	OR the contents of a 32-bit register or memory operand and a sign-extended immediate 8-bit value.
OR <i>reg/mem64</i> , <i>imm8</i>	83 /1 <i>ib</i>	OR the contents of a 64-bit register or memory operand and a sign-extended immediate 8-bit value.
OR <i>reg/mem8</i> , <i>reg8</i>	08 / <i>r</i>	OR the contents of an 8-bit register or memory operand with the contents of an 8-bit register.

Mnemonic	Opcode	Description
OR <i>reg/mem16, reg16</i>	09/r	OR the contents of a 16-bit register or memory operand with the contents of a 16-bit register.
OR <i>reg/mem32, reg32</i>	09/r	OR the contents of a 32-bit register or memory operand with the contents of a 32-bit register.
OR <i>reg/mem64, reg64</i>	09/r	OR the contents of a 64-bit register or memory operand with the contents of a 64-bit register.
OR <i>reg8, reg/mem8</i>	0A/r	OR the contents of an 8-bit register with the contents of an 8-bit register or memory operand.
OR <i>reg16, reg/mem16</i>	0B/r	OR the contents of a 16-bit register with the contents of a 16-bit register or memory operand.
OR <i>reg32, reg/mem32</i>	0B/r	OR the contents of a 32-bit register with the contents of a 32-bit register or memory operand.
OR <i>reg64, reg/mem64</i>	0B/r	OR the contents of a 64-bit register with the contents of a 64-bit register or memory operand.

The following chart summarizes the effect of this instruction:

X	Y	X OR Y
0	0	0
0	1	1
1	0	1
1	1	1

Related Instructions

AND, NEG, NOT, XOR

rFLAGS Affected

ID	VIP	VIF	AC	VM	RF	NT	IOPL	OF	DF	IF	TF	SF	ZF	AF	PF	CF
								0				M	M	U	M	0
21	20	19	18	17	16	14	13–12	11	10	9	8	7	6	4	2	0

Note: Bits 31–22, 15, 5, 3, and 1 are reserved. A flag set to 1 or cleared to 0 is M (modified). Unaffected flags are blank. Undefined flags are U.

Exceptions

Exception	Real	Virtual 8086	Protected	Cause of Exception
Stack, #SS	X	X	X	A memory address exceeded the stack segment limit or was non-canonical.
General protection, #GP	X	X	X	A memory address exceeded a data segment limit or was non-canonical.
			X	The destination operand was in a non-writable segment.
			X	A null data segment was used to reference memory.
Page fault, #PF		X	X	A page fault resulted from the execution of the instruction.
Alignment check, #AC		X	X	An unaligned memory reference was performed while alignment checking was enabled.

OUT Output to Port

Copies the value from the AL, AX, or EAX register (second operand) to an I/O port (first operand). The port address can be a byte-immediate value (00h to FFh) or the value in the DX register (0000h to FFFFh). The source register used determines the size of the port (8, 16, or 32 bits).

If the operand size is 64 bits, OUT only writes to a 32-bit I/O port.

If the CPL is higher than the IOPL or the mode is virtual mode, OUT checks the I/O permission bitmap in the TSS before allowing access to the I/O port. See Volume 2 for details on the TSS I/O permission bitmap.

Mnemonic	Opcode	Description
OUT <i>imm8</i> , AL	E6 <i>ib</i>	Output the byte in the AL register to the port specified by an 8-bit immediate value.
OUT <i>imm8</i> , AX	E7 <i>ib</i>	Output the word in the AX register to the port specified by an 8-bit immediate value.
OUT <i>imm8</i> , EAX	E7 <i>ib</i>	Output the doubleword in the EAX register to the port specified by an 8-bit immediate value.
OUT DX, AL	EE	Output byte in AL to the output port specified in DX.
OUT DX, AX	EF	Output byte in AX to the output port specified in DX.
OUT DX, EAX	EF	Output byte in EAX to the output port specified in DX.

Related Instructions

IN, INS_x, OUTS_x

rFLAGS Affected

None

Exceptions

Exception	Real	Virtual 8086	Protected	Cause of Exception
General protection, #GP		X		One or more I/O permission bits were set in the TSS for the accessed port.
			X	The CPL was greater than the IOPL and one or more I/O permission bits were set in the TSS for the accessed port.
Page fault (#PF)		X	X	A page fault resulted from the execution of the instruction.

OUTS Output String

OUTSB

OUTSW

OUTSD

Copies data from the memory location pointed to by DS:rSI to the I/O port address (0000h to FFFFh) specified in the DX register, and then increments or decrements the rSI register according to the setting of the DF flag in the rFLAGS register.

If the DF flag is 0, the instruction increments rSI; otherwise, it decrements rSI. It increments or decrements the pointer by 1, 2, or 4, depending on the size of the value being copied.

The OUTS x instruction uses an explicit memory operand (second operand) to determine the type (size) of the value being copied, but always uses DS:rSI for the location of the value to copy. The explicit register operand specifies the I/O port address and must always be DX.

The no-operands forms of the instruction use the DS:[rSI] register pair to point to the data to be copied and the DX register as the destination. The mnemonic specifies the size of the I/O port and the type (size) of the value being copied.

The OUTS x instruction supports the REP prefix. For details about the REP prefix, see “Repeat Prefixes” on page 10.

If the operand size is 64-bits, OUTS only writes to a 32-bit I/O port.

If the CPL is higher than the IOPL or the mode is virtual mode, OUTS x checks the I/O permission bitmap in the TSS before allowing access to the I/O port. See Volume 2 for details on the TSS I/O permission bitmap.

Mnemonic	Opcode	Description
OUTS DX, <i>mem8</i>	6E	Output the byte in DS:rSI to the port specified in DX, then increment or decrement rSI.
OUTS DX, <i>mem16</i>	6F	Output the word in DS:rSI to the port specified in DX, then increment or decrement rSI.
OUTS DX, <i>mem32</i>	6F	Output the doubleword in DS:rSI to the port specified in DX, then increment or decrement rSI.

Mnemonic	Opcode	Description
OUTSB	6E	Output the byte in DS:rSI to the port specified in DX, then increment or decrement rSI.
OUTSW	6F	Output the word in DS:rSI to the port specified in DX, then increment or decrement rSI.
OUTSD	6F	Output the doubleword in DS:rSI to the port specified in DX, then increment or decrement rSI.

Related Instructions

IN, INSx, OUT

rFLAGS Affected

None

Exceptions

Exception	Real	Virtual 8086	Protected	Cause of Exception
Stack, #SS	X	X	X	A memory address exceeded the stack segment limit or was non-canonical.
General protection, #GP	X	X	X	A memory address exceeded a data segment limit or was non-canonical.
			X	A null data segment was used to reference memory.
			X	One or more I/O permission bits were set in the TSS for the accessed port.
Page fault, #PF		X	X	The CPL was greater than the IOPL and one or more I/O permission bits were set in the TSS for the accessed port.
Alignment check, #AC		X	X	A page fault resulted from the execution of the instruction.
		X	X	An unaligned memory reference is performed while alignment checking was enabled.

POP**Pop Stack**

Copies the value pointed to by the stack pointer (SS:rSP) to the specified register or memory location and then increments the rSP by 2 for a 16-bit pop, 4 for a 32-bit pop, or 8 for a 64-bit pop.

The operand-size attribute determines the amount by which the stack pointer is incremented (2,4 or 8 bytes). The stack-size attribute determines whether SP, ESP, or RSP is incremented.

For forms of the instruction that load a segment register (POP DS, POP ES, POP FS, POP GS, POP SS), the source operand must be a valid segment selector. When a segment selector is popped into a segment register, the processor also loads all associated descriptor information into the hidden part of the register and validates it.

It is possible to pop a null segment selector value (0000–0003h) into the DS, ES, FS, or GS register. This action does not cause a general protection fault, but a subsequent reference to such a segment *does* cause a #GP exception. For more information about segment selectors, see “Segment Selectors and Registers” on page 84.

In 64-bit mode, the POP operand size defaults to 64 bits and there is no prefix available to encode a 32-bit operand size. Using POP DS, POP ES, or POP SS instruction in 64-bit mode generates an invalid-opcode exception.

This instruction cannot pop a value into the CS register. The RET (Far) instruction performs this function.

Mnemonic	Opcode	Description
POP <i>reg/mem16</i>	8F /0	Pop the top of the stack into a 16-bit register or memory location.
POP <i>reg/mem32</i>	8F /0	Pop the top of the stack into a 32-bit register or memory location. (No prefix for encoding this in 64-bit mode.)
POP <i>reg/mem64</i>	8F /0	Pop the top of the stack into a 64-bit register or memory location.
POP <i>reg16</i>	58 + <i>rw</i>	Pop the top of the stack into a 16-bit register.
POP <i>reg32</i>	58 + <i>rd</i>	Pop the top of the stack into a 32-bit register. (No prefix for encoding this in 64-bit mode.)
POP <i>reg64</i>	58 + <i>rq</i>	Pop the top of the stack into a 64-bit register.
POP DS	1F	Pop the top of the stack into the DS register. (Invalid in 64-bit mode.)

Mnemonic	Opcode	Description
POP ES	07	Pop the top of the stack into the ES register. (Invalid in 64-bit mode.)
POP SS	17	Pop the top of the stack into the SS register. (Invalid in 64-bit mode.)
POP FS	0F A1	Pop the top of the stack into the FS register.
POP GS	0F A9	Pop the top of the stack into the GS register.

Related Instructions

PUSH

rFLAGS Affected

None

Exceptions

Exception	Real	Virtual 8086	Protected	Cause of Exception
Invalid opcode, #UD			X	POP DS, POP ES, or POP SS was executed in 64-bit mode.
Segment not present, #NP (selector)			X	The DS, ES, FS, or GS register was loaded with a non-null segment selector and the segment was marked not present.
Stack, #SS	X	X	X	A memory address exceeded the stack segment limit or was non-canonical.
Stack, #SS (selector)			X	The SS register was loaded with a non-null segment selector and the segment was marked not present.
General protection, #GP	X	X	X	A memory address exceeded a data segment limit or was non-canonical.
			X	The destination operand was in a non-writable segment.
			X	A null data segment was used to reference memory.

Exception	Real	Virtual 8086	Protected	Cause of Exception
General protection, #GP (selector)			X	A segment register was loaded and the segment descriptor exceeded the descriptor table limit.
			X	A segment register was loaded and the segment selector's TI bit was set, but the LDT selector was a null selector.
			X	The SS register was loaded with a null segment selector in non-64-bit mode or while CPL = 3.
			X	The SS register was loaded and the segment selector RPL and the segment descriptor DPL were not equal to the CPL.
			X	The SS register was loaded and the segment pointed to was a not a writable data segment.
			X	The DS, ES, FS, or GS register was loaded and the segment pointed to was a data or non-conforming code segment, but the RPL or the CPL was greater than the DPL.
			X	The DS, ES, FS, or GS register was loaded and the segment pointed to was not a data segment or readable code segment.
Page fault, #PF		X	X	A page fault resulted from the execution of the instruction.
Alignment check, #AC		X	X	An unaligned memory reference was performed while alignment checking was enabled.

POPA POPAD

POP All GPRs

Pops words or doublewords from the stack into the general-purpose registers in the following order: eDI, eSI, eBP, eSP (image is popped and discarded), eBX, eDX, eCX, and eAX. The instruction increments the stack pointer by 16 or 32, depending on the operand size.

Using the POPA or POPAD instructions in 64-bit mode generates an invalid-opcode exception.

Mnemonic	Opcode	Description
POPA	61	Pop the DI, SI, BP, SP, BX, DX, CX, and AX registers. (Invalid in 64-bit mode.)
POPAD	61	Pop the EDI, ESI, EBP, ESP, EBX, EDX, ECX, and EAX registers. (Invalid in 64-bit mode.)

Related Instructions

PUSHA, PUSHAD

rFLAGS Affected

None

Exceptions

Exception	Real	Virtual 8086	Protected	Cause of Exception
Invalid opcode (#UD)			X	This instruction was executed in 64-bit mode.
Stack, #SS	X	X	X	A memory address exceeded the stack segment limit.
Page fault, #PF		X	X	A page fault resulted from the execution of the instruction.
Alignment check, #AC		X	X	An unaligned memory reference was performed while alignment checking was enabled.

POPF

POPF to rFLAGS

POPFD

POPFQ

Pops a word, doubleword, or quadword from the stack into the rFLAGS register and then increments the stack pointer by 2, 4, or 8, depending on the operand size.

In protected or real mode, all the non-reserved flags in the rFLAGS register can be modified, except the VIP, VIF, and VM flags, which are unchanged. In protected mode, at a privilege level greater than 0 the IOPL is also unchanged. The instruction alters the interrupt flag (IF) only when the CPL is less than or equal to the IOPL.

In virtual-8086 mode, if IOPL field is less than 3, attempting to execute a POPF*x* or PUSHF*x* instruction while VME is not enabled, or the operand size is not 16-bit, generates a #GP exception.

In 64-bit mode, this instruction defaults to a 64-bit operand size; there is no prefix available to encode of a 32-bit operand size.

Mnemonic	Opcode	Description
POPF	9D	Pop a word from the stack into the FLAGS register.
POPFD	9D	Pop a double word from the stack into the EFLAGS register. (No prefix for encoding this in 64-bit mode.)
POPFQ	9D	Pop a quadword from the stack to the RFLAGS register.

Action

// See "Pseudocode Definitions" on page 49.

POPF_START:

```
IF (REAL_MODE)
    POPF_REAL
ELIF (PROTECTED_MODE)
    POPF_PROTECTED
ELSE // (VIRTUAL_MODE)
    POPF_VIRTUAL
```

POPF_REAL:

```
POP.v temp_RFLAGS
```

```

RFLAGS.v = temp_RFLAGS          // VIF,VIP,VM unchanged
                                // RF cleared
EXIT

```

POPF_PROTECTED:

```

POP.v temp_RFLAGS
RFLAGS.v = temp_RFLAGS          // VIF,VIP,VM unchanged
                                // IOPL changed only if (CPL=0)
                                // IF changed only if (CPL<=old_RFLAGS.IOPL)
                                // RF cleared
EXIT

```

POPF_VIRTUAL:

```

IF (RFLAGS.IOPL=3)
{
    POP.v temp_RFLAGS
    RFLAGS.v = temp_RFLAGS      // VIF,VIP,VM,IOPL unchanged
                                // RF cleared
    EXIT
}
ELIF ((CR4.VME=1) && (OPERAND_SIZE=16))
{
    POP.w temp_RFLAGS
    IF (((temp_RFLAGS.IF=1) && (RFLAGS.VIP=1)) || (temp_RFLAGS.TF=1))
        EXCEPTION [#GP(0)]
                                // notify the virtual-mode-manager to deliver
                                // the task's pending interrupts
    RFLAGS.w = temp_RFLAGS      // IF,IOPL unchanged
                                // RFLAGS.VIF=temp_RFLAGS.IF
                                // RF cleared
    EXIT
}
ELSE // ((RFLAGS.IOPL<3) && ((CR4.VME=0) || (OPERAND_SIZE!=16)))
    EXCEPTION [#GP(0)]

```

Related Instructions

PUSHF, PUSHFD, PUSHFQ

ID	VIP	VIF	AC	VM	RF	NT	IOPL	OF	DF	IF	TF	SF	ZF	AF	PF	CF
M		M	M		0	M	M	M	M	M	M	M	M	M	M	M
21	20	19	18	17	16	14	13-12	11	10	9	8	7	6	4	2	0
<i>Note: Bits 31-22, 15, 5, 3, and 1 are reserved. A flag set to 1 or cleared to 0 is M (modified). Unaffected flags are blank. Undefined flags are U.</i>																

Exceptions

Exception	Real	Virtual 8086	Protected	Cause of Exception
Stack, #SS	X	X	X	A memory address exceeded the stack segment limit or was non-canonical.
General protection, #GP		X		The I/O privilege level was less than 3 and one of the following conditions was true: <ul style="list-style-type: none"> • CR4.VME was 0. • The effective operand size was 32-bit. • Both the original EFLAGS.VIP and the new EFLAGS.IF bits were set. • The new EFLAGS.TF bit was set.
Page fault, #PF		X	X	A page fault resulted from the execution of the instruction.
Alignment check, #AC		X	X	An unaligned memory reference was performed while alignment checking was enabled.

PREFETCH Prefetch L1 Data-Cache Line PREFETCHW

PREFETCH and PREFETCHW are 3DNow!™ instructions. They load a cache line into the L1 data cache from the specified memory address. The PREFETCH instruction loads a cache line even if the *mem8* address is not aligned with the start of the line. If a cache hit occurs, or if a memory fault is detected, no bus cycle is initiated, and the instruction is treated as a NOP.

The PREFETCHW instruction loads the prefetched line and sets the cache-line state to Modified, in anticipation of subsequent data writes to the line. The PREFETCH instruction, by contrast, typically (depending on hardware implementation) sets the cache-line state to Exclusive.

The opcodes for the instructions include the ModRM byte, and only the memory form of ModRM is valid. The register form of ModRM causes an invalid-opcode exception. Because there is no destination register, the three destination register field bits of the ModRM byte define the type of prefetch to be performed. The bit patterns 000b and 001b define the PREFETCH and PREFETCHW instructions, respectively. All other bit patterns are reserved for future use.

The *reserved* PREFETCH types do not result in an invalid-opcode exception if executed. Instead, for forward compatibility with future processors that may implement additional forms of the PREFETCH instruction, all reserved PREFETCH types are implemented as synonyms of the basic PREFETCH type (the PREFETCH instruction with type 000b).

The operation of these instructions is implementation-dependent. The processor implementation can ignore or change these instructions. The size of the cache line also depends on the implementation, with a minimum size of 32 bytes. For details on the use of this instruction, see the data sheet or other software-optimization documentation relating to particular hardware implementations.

Mnemonic	Opcode	Description
PREFETCH <i>mem8</i>	0F 0D /0	Prefetch processor cache line into L1 data cache.
PREFETCHW <i>mem8</i>	0F 0D /1	Prefetch processor cache line into L1 data cache and mark it modified.

Related Instructions

PREFETCHlevel

rFLAGS Affected

None

Exceptions

Exception (vector)	Real	Virtual 8086	Protected	Cause of Exception
Invalid opcode, #UD	X	X	X	The AMD 3DNow!™ instructions are not supported, as indicated by bit 31 of CPUID extended function 8000_0001h; and Long Mode is not supported, as indicated by bit 29 of CPUID extended function 8000_0001h.
	X	X	X	The operand was a register.

PREFETCH/level/**Prefetch Data to Cache Level /level/**

Loads a cache line from the specified memory address into the data-cache level specified by the locality reference bits 5–3 of the ModRM byte. Table 3-15 on page 229 lists the locality reference options for the instruction.

This instruction loads a cache line even if the *mem8* address is not aligned with the start of the line. If the cache line is already contained in a cache level that is lower than the specified locality reference, or if a memory fault is detected, a bus cycle is not initiated and the instruction is treated as a NOP.

The operation of this instruction is implementation-dependent. The processor implementation can ignore or change this instruction. The size of the cache line also depends on the implementation, with a minimum size of 32 bytes. AMD processors alias PREFETCH1 and PREFETCH2 to PREFETCH0. For details on the use of this instruction, see the software-optimization documentation relating to particular hardware implementations.

Mnemonic	Opcode	Description
PREFETCHNTA <i>mem8</i>	0F 18 /0	Move data closer to the processor using the NTA reference.
PREFETCHT0 <i>mem8</i>	0F 18 /1	Move data closer to the processor using the T0 reference.
PREFETCHT1 <i>mem8</i>	0F 18 /2	Move data closer to the processor using the T1 reference.
PREFETCHT2 <i>mem8</i>	0F 18 /3	Move data closer to the processor using the T2 reference.

Table 3-15. Locality References for the Prefetch Instructions

Locality Reference	Description
NTA	Non-Temporal Access—Move the specified data into the processor with minimum cache pollution. This is intended for data that will be used only once, rather than repeatedly. The specific technique for minimizing cache pollution is implementation-dependent and may include such techniques as allocating space in a software-invisible buffer, allocating a cache line in only a single way, etc. For details, see the software-optimization documentation for a particular hardware implementation.
T0	All Cache Levels—Move the specified data into all cache levels.
T1	Level 2 and Higher—Move the specified data into all cache levels except 0th level (L1) cache.
T2	Level 3 and Higher—Move the specified data into all cache levels except 0th level (L1) and 1st level (L2) caches.

Related Instructions

PREFETCH, PREFETCHW

rFLAGS Affected

None

Exceptions

None

PUSH Push onto Stack

Decrements the stack pointer and then copies the specified immediate value or the value in the specified register or memory location to the top of the stack (the memory location pointed to by SS:rSP).

The operand-size attribute determines the number of bytes pushed to the stack. The stack-size attribute determines whether SP, ESP, or RSP is the stack pointer. The address-size attribute is used only to locate the memory operand when pushing a memory operand to the stack.

If the instruction pushes the stack pointer (rSP), the resulting value on the stack is that of rSP before execution of the instruction.

There is a PUSH CS instruction but no corresponding POP CS. The RET (Far) instruction pops a value from the top of stack into the CS register as part of its operation.

In 64-bit mode, the operand size of all PUSH instructions defaults to 64 bits, and there is no prefix available to encode a 32-bit operand size. Using the PUSH CS, PUSH DS, PUSH ES, or PUSH SS instructions in 64-bit mode generates an invalid-opcode exception.

Pushing an odd number of 16-bit operands when the stack address-size attribute is 32 results in a misaligned stack pointer.

Mnemonic	Opcode	Description
PUSH <i>reg/mem16</i>	FF /6	Push the contents of a 16-bit register or memory operand onto the stack.
PUSH <i>reg/mem32</i>	FF /6	Push the contents of a 32-bit register or memory operand onto the stack. (No prefix for encoding this in 64-bit mode.)
PUSH <i>reg/mem64</i>	FF /6	Push the contents of a 64-bit register or memory operand onto the stack.
PUSH <i>reg16</i>	50 + <i>rw</i>	Push the contents of a 16-bit register onto the stack.
PUSH <i>reg32</i>	50 + <i>rd</i>	Push the contents of a 32-bit register onto the stack. (No prefix for encoding this in 64-bit mode.)
PUSH <i>reg64</i>	50 + <i>rq</i>	Push the contents of a 64-bit register onto the stack.
PUSH <i>imm8</i>	6A	Push an 8-bit immediate value (sign-extended to 16, 32, or 64 bits) onto the stack.

Mnemonic	Opcode	Description
PUSH <i>imm16</i>	68	Push a 16-bit immediate value onto the stack.
PUSH <i>imm32</i>	68	Push a 32-bit immediate value onto the stack. (No prefix for encoding this in 64-bit mode.)
PUSH <i>imm64</i>	68	Push a sign-extended 32-bit immediate value onto the stack.
PUSH CS	0E	Push the CS selector onto the stack. (Invalid in 64-bit mode.)
PUSH SS	16	Push the SS selector onto the stack. (Invalid in 64-bit mode.)
PUSH DS	1E	Push the DS selector onto the stack. (Invalid in 64-bit mode.)
PUSH ES	06	Push the ES selector onto the stack. (Invalid in 64-bit mode.)
PUSH FS	0F A0	Push the FS selector onto the stack.
PUSH GS	0F A8	Push the GS selector onto the stack.

Related Instructions

POP

rFLAGS Affected

None

Exceptions

Exception	Real	Virtual 8086	Protected	Cause of Exception
Invalid opcode, #UD			X	PUSH CS, PUSH DS, PUSH ES, or PUSH SS was executed in 64-bit mode.
Stack, #SS	X	X	X	A memory address exceeded the stack segment limit or was non-canonical.
General protection, #GP	X	X	X	A memory address exceeded a data segment limit or was non-canonical.
			X	A null data segment was used to reference memory.
Page fault, #PF		X	X	A page fault resulted from the execution of the instruction.
Alignment check, #AC		X	X	An unaligned memory reference was performed while alignment checking was enabled.

PUSHA **Push All GPRs onto Stack** **PUSHAD**

Pushes the contents of the eAX, eCX, eDX, eBX, eSP (original value), eBP, eSI, and eDI general-purpose registers onto the stack in that order. This instruction decrements the stack pointer by 16 or 32 depending on operand size.

Using the PUSHA or PUSHAD instruction in 64-bit mode generates an invalid-opcode exception.

Mnemonic	Opcode	Description
PUSHA	60	Push the contents of the AX, CX, DX, BX, original SP, BP, SI, and DI registers onto the stack. (Invalid in 64-bit mode.)
PUSHAD	60	Push the contents of the EAX, ECX, EDX, EBX, original ESP, EBP, ESI, and EDI registers onto the stack. (Invalid in 64-bit mode.)

Related Instructions

POPA, POPAD

rFLAGS Affected

None

Exceptions

Exception	Real	Virtual 8086	Protected	Cause of Exception
Invalid opcode, #UD			X	This instruction was executed in 64-bit mode.
Stack, #SS	X	X	X	A memory address exceeded the stack segment limit.
Page fault, #PF		X	X	A page fault resulted from the execution of the instruction.
Alignment check, #AC		X	X	An unaligned memory reference was performed while alignment checking was enabled.

PUSHF Push rFLAGS onto Stack

PUSHFD

PUSHFQ

Decrements the rSP register and copies the rFLAGS register (except for the VM and RF flags) onto the stack. The instruction clears the VM and RF flags in the rFLAGS image before putting it on the stack.

The instruction pushes 2, 4, or 8 bytes, depending on the operand size.

In 64-bit mode, this instruction defaults to a 64-bit operand size and there is no prefix available to encode a 32-bit operand size.

In virtual-8086 mode, if system software has set the IOPL field to a value less than 3, a general-protection exception occurs if application software attempts to execute PUSHF_x or POPF_x while VME is not enabled or the operand size is not 16-bit.

Mnemonic	Opcode	Description
PUSHF	9C	Push the FLAGS word onto the stack.
PUSHFD	9C	Push the EFLAGS doubleword onto stack. (No prefix encoding this in 64-bit mode.)
PUSHFQ	9C	Push the RFLAGS quadword onto stack.

Action

// See "Pseudocode Definitions" on page 49.

```

PUSHF_START:
IF (REAL_MODE)
    PUSHF_REAL
ELSIF (PROTECTED_MODE)
    PUSHF_PROTECTED
ELSE // (VIRTUAL_MODE)
    PUSHF_VIRTUAL

PUSHF_REAL:
    PUSH.v old_RFLAGS // Pushed with RF and VM cleared.
    EXIT

PUSHF_PROTECTED:
    PUSH.v old_RFLAGS // Pushed with RF cleared.
    EXIT

```

```

PUSHF_VIRTUAL:
  IF (RFLAGS.IOPL=3)
  {
    PUSH.v old_RFLAGS // Pushed with RF,VM cleared.
    EXIT
  }
  ELIF ((CR4.VME=1) && (OPERAND_SIZE=16))
  {
    PUSH.v old_RFLAGS // Pushed with VIF in the IF position.
                        // Pushed with IOPL=3.
    EXIT
  }
  ELSE // ((RFLAGS.IOPL<3) && ((CR4.VME=0) || (OPERAND_SIZE!=16)))
    EXCEPTION [#GP(0)]

```

Related Instructions

POPF, POPFD, POPFQ

rFLAGS Affected

None

Exceptions

Exception	Real	Virtual 8086	Protected	Cause of Exception
Stack, #SS	X	X	X	A memory address exceeded the stack segment limit or was non-canonical.
General protection, #GP		X		The I/O privilege level was less than 3 and either VME was not enabled or the operand size was not 16-bit.
Page fault, #PF		X	X	A page fault resulted from the execution of the instruction.
Alignment check, #AC		X	X	An unaligned memory reference was performed while alignment checking was enabled.

RCL Rotate Through Carry Left

Rotates the bits of a register or memory location (first operand) to the left (more significant bit positions) and through the carry flag by the number of bit positions in an unsigned immediate value or the CL register (second operand). The bits rotated through the carry flag are rotated back in at the right end (lsb) of the first operand location.

The processor masks the upper three bits of the count operand, thus restricting the count to a number between 0 and 31. When the destination is 64 bits wide, the processor masks the upper two bits of the count, providing a count in the range of 0 to 63.

For 1-bit rotates, the instruction sets the OF flag to the exclusive OR of the CF bit (after the rotate) and the most significant bit of the result. When the rotate count is greater than 1, the OF flag is undefined. When the rotate count is 0, no flags are affected.

Mnemonic	Opcode	Description
RCL <i>reg/mem8</i> ,1	D0 /2	Rotate the 9 bits consisting of the carry flag and an 8-bit register or memory location left 1 bit.
RCL <i>reg/mem8</i> , CL	D2 /2	Rotate the 9 bits consisting of the carry flag and an 8-bit register or memory location left the number of bits specified in the CL register.
RCL <i>reg/mem8</i> , <i>imm8</i>	C0 /2 <i>ib</i>	Rotate the 9 bits consisting of the carry flag and an 8-bit register or memory location left the number of bits specified by an 8-bit immediate value.
RCL <i>reg/mem16</i> , 1	D1 /2	Rotate the 17 bits consisting of the carry flag and a 16-bit register or memory location left 1 bit.
RCL <i>reg/mem16</i> , CL	D3 /2	Rotate the 17 bits consisting of the carry flag and a 16-bit register or memory location left the number of bits specified in the CL register.
RCL <i>reg/mem16</i> , <i>imm8</i>	C1 /2 <i>ib</i>	Rotate the 17 bits consisting of the carry flag and a 16-bit register or memory location left the number of bits specified by an 8-bit immediate value.
RCL <i>reg/mem32</i> , 1	D1 /2	Rotate the 33 bits consisting of the carry flag and a 32-bit register or memory location left 1 bit.

Mnemonic	Opcode	Description
RCL <i>reg/mem32, CL</i>	D3 /2	Rotate 33 bits consisting of the carry flag and a 32-bit register or memory location left the number of bits specified in the CL register.
RCL <i>reg/mem32, imm8</i>	C1 /2 <i>ib</i>	Rotate the 33 bits consisting of the carry flag and a 32-bit register or memory location left the number of bits specified by an 8-bit immediate value.
RCL <i>reg/mem64, 1</i>	D1 /2	Rotate the 65 bits consisting of the carry flag and a 64-bit register or memory location left 1 bit.
RCL <i>reg/mem64, CL</i>	D3 /2	Rotate the 65 bits consisting of the carry flag and a 64-bit register or memory location left the number of bits specified in the CL register.
RCL <i>reg/mem64, imm8</i>	C1 /2 <i>ib</i>	Rotates the 65 bits consisting of the carry flag and a 64-bit register or memory location left the number of bits specified by an 8-bit immediate value.

Related Instructions

RCR, ROL, ROR

rFLAGS Affected

ID	VIP	VIF	AC	VM	RF	NT	IOPL	OF	DF	IF	TF	SF	ZF	AF	PF	CF
								M								M
21	20	19	18	17	16	14	13–12	11	10	9	8	7	6	4	2	0

Note: Bits 31–22, 15, 5, 3, and 1 are reserved. A flag set to 1 or cleared to 0 is M (modified). Unaffected flags are blank. Undefined flags are U.

Exceptions

Exception	Real	Virtual 8086	Protected	Cause of Exception
Stack, #SS	X	X	X	A memory address exceeded the stack segment limit or was non-canonical.
General protection, #GP	X	X	X	A memory address exceeded a data segment limit or was non-canonical.
			X	The destination operand was in a non-writable segment.
			X	A null data segment was used to reference memory.

Exception	Real	Virtual 8086	Protected	Cause of Exception
Page fault, #PF		X	X	A page fault resulted from the execution of the instruction.
Alignment check, #AC		X	X	An unaligned memory reference was performed while alignment checking was enabled.

RCR Rotate Through Carry Right

Rotates the bits of a register or memory location (first operand) to the right (toward the less significant bit positions) and through the carry flag by the number of bit positions in an unsigned immediate value or the CL register (second operand). The bits rotated through the carry flag are rotated back in at the left end (msb) of the first operand location.

The processor masks the upper three bits in the count operand, thus restricting the count to a number between 0 and 31. When the destination is 64 bits wide, the processor masks the upper two bits of the count, providing a count in the range of 0 to 63.

For 1-bit rotates, the instruction sets the OF flag to the exclusive OR of the CF flag (before the rotate) and the most significant bit of the original value. When the rotate count is greater than 1, the OF flag is undefined. When the rotate count is 0, no flags are affected.

Mnemonic	Opcode	Description
RCR <i>reg/mem8, 1</i>	D0 /3	Rotate the 9 bits consisting of the carry flag and an 8-bit register or memory location right 1 bit.
RCR <i>reg/mem8, CL</i>	D2 /3	Rotate the 9 bits consisting of the carry flag and an 8-bit register or memory location right the number of bits specified in the CL register.
RCR <i>reg/mem8, imm8</i>	C0 /3 <i>ib</i>	Rotate the 9 bits consisting of the carry flag and an 8-bit register or memory location right the number of bits specified by an 8-bit immediate value.
RCR <i>reg/mem16, 1</i>	D1 /3	Rotate the 17 bits consisting of the carry flag and a 16-bit register or memory location right 1 bit.
RCR <i>reg/mem16, CL</i>	D3 /3	Rotate the 17 bits consisting of the carry flag and a 16-bit register or memory location right the number of bits specified in the CL register.
RCR <i>reg/mem16, imm8</i>	C1 /3 <i>ib</i>	Rotate the 17 bits consisting of the carry flag and a 16-bit register or memory location right the number of bits specified by an 8-bit immediate value.
RCR <i>reg/mem32, 1</i>	D1 /3	Rotate the 33 bits consisting of the carry flag and a 32-bit register or memory location right 1 bit.

Mnemonic	Opcode	Description
RCR <i>reg/mem32,CL</i>	D3 /3	Rotate 33 bits consisting of the carry flag and a 32-bit register or memory location right the number of bits specified in the CL register.
RCR <i>reg/mem32,imm8</i>	C1 /3 <i>ib</i>	Rotate the 33 bits consisting of the carry flag and a 32-bit register or memory location right the number of bits specified by an 8-bit immediate value.
RCR <i>reg/mem64,1</i>	D1 /3	Rotate the 65 bits consisting of the carry flag and a 64-bit register or memory location right 1 bit.
RCR <i>reg/mem64,CL</i>	D3 /3	Rotate 65 bits consisting of the carry flag and a 64-bit register or memory location right the number of bits specified in the CL register.
RCR <i>reg/mem64,imm8</i>	C1 /3 <i>ib</i>	Rotate the 65 bits consisting of the carry flag and a 64-bit register or memory location right the number of bits specified by an 8-bit immediate value.

Related Instructions

RCL, ROR, ROL

rFLAGS Affected

ID	VIP	VIF	AC	VM	RF	NT	IOPL	OF	DF	IF	TF	SF	ZF	AF	PF	CF
								M								M
21	20	19	18	17	16	14	13–12	11	10	9	8	7	6	4	2	0

Note: Bits 31–22, 15, 5, 3, and 1 are reserved. A flag set to 1 or cleared to 0 is M (modified). Unaffected flags are blank. Undefined flags are U.

Exceptions

Exception	Real	Virtual 8086	Protected	Cause of Exception
Stack, #SS	X	X	X	A memory address exceeded the stack segment limit or was non-canonical.
General protection, #GP	X	X	X	A memory address exceeded a data segment limit or was non-canonical.
			X	The destination operand was in a non-writable segment.
			X	A null data segment was used to reference memory.

Exception	Real	Virtual 8086	Protected	Cause of Exception
Page fault, #PF		X	X	A page fault resulted from the execution of the instruction.
Alignment check, #AC		X	X	An unaligned memory reference was performed while alignment checking was enabled.

RET (Near) Near Return from Called Procedure

Returns from a procedure previously entered by a CALL near instruction. This form of the RET instruction returns to a calling procedure within the current code segment.

This instruction pops the rIP from the stack, with the size of the pop determined by the operand size. The new rIP is then zero-extended to 64 bits. The RET instruction can accept an immediate value operand that it adds to the rSP after it pops the target rIP. This action skips over any parameters previously passed back to the subroutine that are no longer needed.

In 64-bit mode, the operand size defaults to 64 bits (eight bytes) without the need for a REX prefix. No prefix is available to encode a 32-bit operand size in 64-bit mode.

See RET (Far) for information on far returns—returns to procedures located outside of the current code segment. For details about control-flow instructions, see “Control Transfers” in Volume 1, and “Control-Transfer Privilege Checks” in Volume 2.

Mnemonic	Opcode	Description
RET	C3	Near return to the calling procedure.
RET <i>imm16</i>	C2 <i>iw</i>	Near return to the calling procedure then pop of the specified number of bytes from the stack.

Related Instructions

CALL (Near), CALL (Far), RET (Far)

rFLAGS Affected

None

Exceptions

Exception	Real	Virtual 8086	Protected	Cause of Exception
Stack, #SS	X	X	X	A memory address exceeded the stack segment limit or was non-canonical.
General protection, #GP	X	X	X	The target offset exceeded the code segment limit or was non-canonical.

Exception	Real	Virtual 8086	Protected	Cause of Exception
Page fault, #PF		X	X	A page fault resulted from the execution of the instruction.
Alignment check, #AC		X	X	An unaligned memory reference was performed while alignment checking was enabled.

RET (Far) Far Return from Called Procedure

Returns from a procedure previously entered by a CALL Far instruction. This form of the RET instruction returns to a calling procedure in a different segment than the current code segment. It can return to the same CPL or to a less privileged CPL.

RET Far pops a target CS and rIP from the stack. If the new code segment is less privileged than the current code segment, the stack pointer is incremented by the number of bytes indicated by the immediate operand, if present; then a new SS and rSP are also popped from the stack.

The final value of rSP is incremented by the number of bytes indicated by the immediate operand, if present. This action skips over the parameters (previously passed to the subroutine) that are no longer needed.

All stack pops are determined by the operand size. If necessary, the target rIP is zero-extended to 64 bits before assuming program control.

If the CPL changes, the data segment selectors are set to NULL for any of the data segments (DS, ES, FS, GS) not accessible at the new CPL.

See RET (Near) for information on near returns—returns to procedures located inside the current code segment. For details about control-flow instructions, see “Control Transfers” in Volume 1, and “Control-Transfer Privilege Checks” in Volume 2.

Mnemonic	Opcode	Description
RETF	CB	Far return to the calling procedure.
RETF <i>imm16</i>	CA <i>iw</i>	Far return to the calling procedure, then pop of the specified number of bytes from the stack.

Action

```
// Far returns (RETF)
// See “Pseudocode Definitions” on page 49.
```

```
RETF_START:
```

```
IF (REAL_MODE)
    RETF_REAL_OR_VIRTUAL
ELSIF (PROTECTED_MODE)
    RETF_PROTECTED
ELSE // (VIRTUAL_MODE)
    RETF_REAL_OR_VIRTUAL
```

RETF_REAL_OR_VIRTUAL:

```
IF (OPCODE = retf imm16)
    temp_IMM = word-sized immediate specified in the instruction,
                zero-extended to 64 bits
ELSE // (OPCODE = retf)
    temp_IMM = 0

POP.v temp_RIP
POP.v temp_CS

IF (temp_RIP > CS.limit)
    EXCEPTION [#GP(0)]

CS.sel = temp_CS
CS.base = temp_CS SHL 4

RSP.s = RSP + temp_IMM
RIP = temp_RIP
EXIT
```

RETF_PROTECTED:

```
IF (OPCODE = retf imm16)
    temp_IMM = word-sized immediate specified in the instruction,
                zero-extended to 64 bits
ELSE // (OPCODE = retf)
    temp_IMM = 0

POP.v temp_RIP
POP.v temp_CS

temp_CPL = temp_CS.rpl

IF (CPL=temp_CPL)
{
    CS = READ_DESCRIPTOR (temp_CS, iret_chk)

    RSP.s = RSP + temp_IMM

    IF ((64BIT_MODE) && (temp_RIP is non-canonical)
        || (!64BIT_MODE) && (temp_RIP > CS.limit))
        EXCEPTION [#GP(0)]

    RIP = temp_RIP
    EXIT
}
ELSE // (CPL!=temp_CPL)
```

```

{
    RSP.s = RSP + temp_IMM

    POP.v temp_RSP
    POP.v temp_SS

    CS = READ_DESCRIPTOR (temp_CS, iret_chk)

    CPL = temp_CPL

    IF ((64BIT_MODE) && (temp_RIP is non-canonical)
        || (!64BIT_MODE) && (temp_RIP > CS.limit))
        EXCEPTION [#GP(0)]

    SS = READ_DESCRIPTOR (temp_SS, ss_chk)

    RSP.s = temp_RSP + temp_IMM

    IF (changing CPL)
    {
        FOR (seg = ES, DS, FS, GS)
            IF ((seg.attr.dpl < CPL) && ((seg.attr.type = 'data')
                || (seg.attr.type = 'non-conforming-code')))
            {
                seg = NULL // can't use lower dpl data segment at higher cpl
            }
    }

    RIP = temp_RIP
    EXIT
}

```

Related Instructions

CALL (Near), CALL (Far), RET (Near)

rFLAGS Affected

None

Exceptions

Exception	Real	Virtual 8086	Protected	Cause of Exception
Segment not present, #NP (selector)			X	The return code segment was marked not present.
Stack, #SS	X	X	X	A memory address exceeded the stack segment limit or was non-canonical.
Stack, #SS (selector)			X	The return stack segment was marked not present.

Exception	Real	Virtual 8086	Protected	Cause of Exception
General protection, #GP	X	X	X	The target offset exceeded the code segment limit or was non-canonical.
General protection, #GP (selector)			X	The return code selector was a null selector.
			X	The return stack selector was a null selector and the return mode was non-64-bit mode or CPL was 3.
			X	The return code or stack descriptor exceeded the descriptor table limit.
			X	The return code or stack selector's TI bit was set but the LDT selector was a null selector.
			X	The segment descriptor for the return code was not a code segment.
			X	The RPL of the return code segment selector was less than the CPL.
			X	The return code segment was non-conforming and the segment selector's DPL was not equal to the RPL of the code segment's segment selector.
			X	The return code segment was conforming and the segment selector's DPL was greater than the RPL of the code segment's segment selector.
			X	The segment descriptor for the return stack was not a writable data segment.
			X	The stack segment descriptor DPL was not equal to the RPL of the return code segment selector.
			X	The stack segment selector RPL was not equal to the RPL of the return code segment selector.
Page fault, #PF		X	X	A page fault resulted from the execution of the instruction.
Alignment check, #AC		X	X	An unaligned-memory reference was performed while alignment checking was enabled.

ROL Rotate Left

Rotates the bits of a register or memory location (first operand) to the left (toward the more significant bit positions) by the number of bit positions in an unsigned immediate value or the CL register (second operand). The bits rotated out left are rotated back in at the right end (lsb) of the first operand location.

The processor masks the upper three bits of the count operand, thus restricting the count to a number between 0 and 31. When the destination is 64 bits wide, it masks the upper two bits of the count, providing a count in the range of 0 to 63.

After completing the rotation, the instruction sets the CF flag to the last bit rotated out (the lsb of the result). For 1-bit rotates, the instruction sets the OF flag to the exclusive OR of the CF bit (after the rotate) and the most significant bit of the result. When the rotate count is greater than 1, the OF flag is undefined. When the rotate count is 0, no flags are affected.

Mnemonic	Opcode	Description
ROL <i>reg/mem8</i> , 1	D0 /0	Rotate an 8-bit register or memory operand left 1 bit.
ROL <i>reg/mem8</i> , CL	D2 /0	Rotate an 8-bit register or memory operand left the number of bits specified in the CL register.
ROL <i>reg/mem8</i> , <i>imm8</i>	C0 /0 <i>ib</i>	Rotate an 8-bit register or memory operand left the number of bits specified by an 8-bit immediate value.
ROL <i>reg/mem16</i> , 1	D1 /0	Rotate a 16-bit register or memory operand left 1 bit.
ROL <i>reg/mem16</i> , CL	D3 /0	Rotate a 16-bit register or memory operand left the number of bits specified in the CL register.
ROL <i>reg/mem16</i> , <i>imm8</i>	C1 /0 <i>ib</i>	Rotate a 16-bit register or memory operand left the number of bits specified by an 8-bit immediate value.
ROL <i>reg/mem32</i> , 1	D1 /0	Rotate a 32-bit register or memory operand left 1 bit.
ROL <i>reg/mem32</i> , CL	D3 /0	Rotate a 32-bit register or memory operand left the number of bits specified in the CL register.
ROL <i>reg/mem32</i> , <i>imm8</i>	C1 /0 <i>ib</i>	Rotate a 32-bit register or memory operand left the number of bits specified by an 8-bit immediate value.
ROL <i>reg/mem64</i> , 1	D1 /0	Rotate a 64-bit register or memory operand left 1 bit.

Mnemonic	Opcode	Description
ROL <i>reg/mem64, CL</i>	D3 /0	Rotate a 64-bit register or memory operand left the number of bits specified in the CL register.
ROL <i>reg/mem64, imm8</i>	C1 /0 <i>ib</i>	Rotate a 64-bit register or memory operand left the number of bits specified by an 8-bit immediate value.

Related Instructions

RCL, RCR, ROR

rFLAGS Affected

ID	VIP	VIF	AC	VM	RF	NT	IOPL	OF	DF	IF	TF	SF	ZF	AF	PF	CF
								M								M
21	20	19	18	17	16	14	13–12	11	10	9	8	7	6	4	2	0

Note: Bits 31–22, 15, 5, 3, and 1 are reserved. A flag set to 1 or cleared to 0 is M (modified). Unaffected flags are blank. Undefined flags are U.

Exceptions

Exception	Real	Virtual 8086	Protected	Cause of Exception
Stack, #SS	X	X	X	A memory address exceeded the stack segment limit or was non-canonical.
General protection, #GP	X	X	X	A memory address exceeded a data segment limit or was non-canonical.
			X	The destination operand was in a non-writable segment.
			X	A null data segment was used to reference memory.
Page fault, #PF		X	X	A page fault resulted from the execution of the instruction.
Alignment check, #AC		X	X	An unaligned memory reference was performed while alignment checking was enabled.

ROR Rotate Right

Rotates the bits of a register or memory location (first operand) to the right (toward the less significant bit positions) by the number of bit positions in an unsigned immediate value or the CL register (second operand). The bits rotated out right are rotated back in at the left end (the most significant bit) of the first operand location.

The processor masks the upper three bits of the count operand, thus restricting the count to a number between 0 and 31. When the destination is 64 bits wide, the processor masks the upper two bits of the count, providing a count in the range of 0 to 63.

After completing the rotation, the instruction sets the CF flag to the last bit rotated out (the most significant bit of the result). For 1-bit rotates, the instruction sets the OF flag to the exclusive OR of the two most significant bits of the result. When the rotate count is greater than 1, the OF flag is undefined. When the rotate count is 0, no flags are affected.

Mnemonic	Opcode	Description
ROR <i>reg/mem8</i> , 1	D0 /1	Rotate an 8-bit register or memory location right 1 bit.
ROR <i>reg/mem8</i> , CL	D2 /1	Rotate an 8-bit register or memory location right the number of bits specified in the CL register.
ROR <i>reg/mem8</i> , <i>imm8</i>	C0 /1 <i>ib</i>	Rotate an 8-bit register or memory location right the number of bits specified by an 8-bit immediate value.
ROR <i>reg/mem16</i> , 1	D1 /1	Rotate a 16-bit register or memory location right 1 bit.
ROR <i>reg/mem16</i> , CL	D3 /1	Rotate a 16-bit register or memory location right the number of bits specified in the CL register.
ROR <i>reg/mem16</i> , <i>imm8</i>	C1 /1 <i>ib</i>	Rotate a 16-bit register or memory location right the number of bits specified by an 8-bit immediate value.
ROR <i>reg/mem32</i> , 1	D1 /1	Rotate a 32-bit register or memory location right 1 bit.
ROR <i>reg/mem32</i> , CL	D3 /1	Rotate a 32-bit register or memory location right the number of bits specified in the CL register.
ROR <i>reg/mem32</i> , <i>imm8</i>	C1 /1 <i>ib</i>	Rotate a 32-bit register or memory location right the number of bits specified by an 8-bit immediate value.
ROR <i>reg/mem64</i> , 1	D1 /1	Rotate a 64-bit register or memory location right 1 bit.

Mnemonic	Opcode	Description
ROR <i>reg/mem64, CL</i>	D3 /1	Rotate a 64-bit register or memory operand right the number of bits specified in the CL register.
ROR <i>reg/mem64, imm8</i>	C1 /1 <i>ib</i>	Rotate a 64-bit register or memory operand right the number of bits specified by an 8-bit immediate value.

Related Instructions

RCL, RCR, ROL

rFLAGS Affected

ID	VIP	VIF	AC	VM	RF	NT	IOPL	OF	DF	IF	TF	SF	ZF	AF	PF	CF
								M								M
21	20	19	18	17	16	14	13–12	11	10	9	8	7	6	4	2	0

Note: Bits 31–22, 15, 5, 3, and 1 are reserved. A flag set to 1 or cleared to 0 is M (modified). Unaffected flags are blank. Undefined flags are U.

Exceptions

Exception	Real	Virtual 8086	Protected	Cause of Exception
Stack, #SS	X	X	X	A memory address exceeded the stack segment limit or was non-canonical.
General protection, #GP	X	X	X	A memory address exceeded a data segment limit or was non-canonical.
			X	The destination operand was in a non-writable segment.
			X	A null data segment was used to reference memory.
Page fault, #PF		X	X	A page fault resulted from the execution of the instruction.
Alignment check, #AC		X	X	An unaligned memory reference was performed while alignment checking was enabled.

SAHF Store AH into Flags

Loads the SF, ZF, AF, PF, and CF flags of the EFLAGS register with values from the corresponding bits in the AH register (bits 7, 6, 4, 2, and 0, respectively). The instruction ignores bits 1, 3, and 5 of register AH; it sets those bits in the EFLAGS register to 1, 0, and 0, respectively.

Mnemonic	Opcode	Description
SAHF	9E	Loads the sign flag, the zero flag, the auxiliary flag, the parity flag, and the carry flag from the AH register into the lower 8 bits of the EFLAGS register.

Related Instructions

LAHF

rFLAGS Affected

ID	VIP	VIF	AC	VM	RF	NT	IOPL	OF	DF	IF	TF	SF	ZF	AF	PF	CF
												M	M	M	M	M
21	20	19	18	17	16	14	13–12	11	10	9	8	7	6	4	2	0

Note: Bits 31–22, 15, 5, 3, and 1 are reserved. A flag set to 1 or cleared to 0 is M (modified). Unaffected flags are blank. Undefined flags are U.

Exceptions

None

SAL Shift Left

SHL

Shifts the bits of a register or memory location (first operand) to the left through the CF bit by the number of bit positions in an unsigned immediate value or the CL register (second operand). The instruction discards bits shifted out of the CF flag. For each bit shift, the SAL instruction clears the least-significant bit to 0. At the end of the shift operation, the CF flag contains the last bit shifted out of the first operand.

The processor masks the upper three bits of the count operand, thus restricting the count to a number between 0 and 31. When the destination is 64 bits wide, the processor masks the upper two bits of the count, providing a count in the range of 0 to 63.

The effect of this instruction is multiplication by powers of two.

For 1-bit shifts, the instruction sets the OF flag to the exclusive OR of the CF bit (after the shift) and the most significant bit of the result. When the shift count is greater than 1, the OF flag is undefined.

If the shift count is 0, no flags are modified.

SHL is an alias to the SAL instruction.

Mnemonic	Opcode	Description
SAL <i>reg/mem8</i> , 1	D0 /4	Shift an 8-bit register or memory location left 1 bit.
SAL <i>reg/mem8</i> , CL	D2 /4	Shift an 8-bit register or memory location left the number of bits specified in the CL register.
SAL <i>reg/mem8</i> , <i>imm8</i>	C0 /4 <i>ib</i>	Shift an 8-bit register or memory location left the number of bits specified by an 8-bit immediate value.
SAL <i>reg/mem16</i> , 1	D1 /4	Shift a 16-bit register or memory location left 1 bit.
SAL <i>reg/mem16</i> , CL	D3 /4	Shift a 16-bit register or memory location left the number of bits specified in the CL register.
SAL <i>reg/mem16</i> , <i>imm8</i>	C1 /4 <i>ib</i>	Shift a 16-bit register or memory location left the number of bits specified by an 8-bit immediate value.
SAL <i>reg/mem32</i> , 1	D1 /4	Shift a 32-bit register or memory location left 1 bit.
SAL <i>reg/mem32</i> , CL	D3 /4	Shift a 32-bit register or memory location left the number of bits specified in the CL register.

Mnemonic	Opcode	Description
<i>SAL reg/mem32, imm8</i>	<i>C1 /4 ib</i>	Shift a 32-bit register or memory location left the number of bits specified by an 8-bit immediate value.
<i>SAL reg/mem64, 1</i>	<i>D1 /4</i>	Shift a 64-bit register or memory location left 1 bit.
<i>SAL reg/mem64, CL</i>	<i>D3 /4</i>	Shift a 64-bit register or memory location left the number of bits specified in the CL register.
<i>SAL reg/mem64, imm8</i>	<i>C1 /4 ib</i>	Shift a 64-bit register or memory location left the number of bits specified by an 8-bit immediate value.
<i>SHL reg/mem8, 1</i>	<i>D0 /4</i>	Shift an 8-bit register or memory location by 1 bit.
<i>SHL reg/mem8, CL</i>	<i>D2 /4</i>	Shift an 8-bit register or memory location left the number of bits specified in the CL register.
<i>SHL reg/mem8, imm8</i>	<i>C0 /4 ib</i>	Shift an 8-bit register or memory location left the number of bits specified by an 8-bit immediate value.
<i>SHL reg/mem16, 1</i>	<i>D1 /4</i>	Shift a 16-bit register or memory location left 1 bit.
<i>SHL reg/mem16, CL</i>	<i>D3 /4</i>	Shift a 16-bit register or memory location left the number of bits specified in the CL register.
<i>SHL reg/mem16, imm8</i>	<i>C1 /4 ib</i>	Shift a 16-bit register or memory location left the number of bits specified by an 8-bit immediate value.
<i>SHL reg/mem32, 1</i>	<i>D1 /4</i>	Shift a 32-bit register or memory location left 1 bit.
<i>SHL reg/mem32, CL</i>	<i>D3 /4</i>	Shift a 32-bit register or memory location left the number of bits specified in the CL register.
<i>SHL reg/mem32, imm8</i>	<i>C1 /4 ib</i>	Shift a 32-bit register or memory location left the number of bits specified by an 8-bit immediate value.
<i>SHL reg/mem64, 1</i>	<i>D1 /4</i>	Shift a 64-bit register or memory location left 1 bit.
<i>SHL reg/mem64, CL</i>	<i>D3 /4</i>	Shift a 64-bit register or memory location left the number of bits specified in the CL register.
<i>SHL reg/mem64, imm8</i>	<i>C1 /4 ib</i>	Shift a 64-bit register or memory location left the number of bits specified by an 8-bit immediate value.

Related Instructions

SAR, SHR, SHLD, SHRD

rFLAGS Affected

ID	VIP	VIF	AC	VM	RF	NT	IOPL	OF	DF	IF	TF	SF	ZF	AF	PF	CF
								M				M	M	U	M	M
21	20	19	18	17	16	14	13–12	11	10	9	8	7	6	4	2	0

Note: Bits 31–22, 15, 5, 3, and 1 are reserved. A flag set to 1 or cleared to 0 is M (modified). Unaffected flags are blank. Undefined flags are U.

Exceptions

Exception	Real	Virtual 8086	Protected	Cause of Exception
Stack, #SS	X	X	X	A memory address exceeded the stack segment limit or was non-canonical.
General protection, #GP	X	X	X	A memory address exceeded a data segment limit or was non-canonical.
			X	The destination operand was in a non-writable segment.
			X	A null data segment was used to reference memory.
Page fault, #PF		X	X	A page fault resulted from the execution of the instruction.
Alignment check, #AC		X	X	An unaligned memory reference was performed while alignment checking was enabled.

SAR Shift Arithmetic Right

Shifts the bits of a register or memory location (first operand) to the right through the CF bit by the number of bit positions in an unsigned immediate value or the CL register (second operand). The instruction discards bits shifted out of the CF flag. At the end of the shift operation, the CF flag contains the last bit shifted out of the first operand.

The SAR instruction does not change the sign bit of the target operand. For each bit shift, it copies the sign bit to the next bit, preserving the sign of the result.

The processor masks the upper three bits of the count operand, thus restricting the count to a number between 0 and 31. When the destination is 64 bits wide, the processor masks the upper two bits of the count, providing a count in the range of 0 to 63.

For 1-bit shifts, the instruction clears the OF flag to 0. When the shift count is greater than 1, the OF flag is undefined.

If the shift count is 0, no flags are modified.

Although the SAR instruction effectively divides the operand by a power of 2, the behavior is different from the IDIV instruction. For example, shifting -11 (FFFFFFF5h) by two bits to the right (that is, divide -11 by 4), gives a result of FFFFFFFDh, or -3 , whereas the IDIV instruction for dividing -11 by 4 gives a result of -2 . This is because the IDIV instruction rounds off the quotient to zero, whereas the SAR instruction rounds off the remainder to zero for positive dividends and to negative infinity for negative dividends. So, for positive operands, SAR behaves like the corresponding IDIV instruction. For negative operands, it gives the same result if and only if all the shifted-out bits are zeroes; otherwise, the result is smaller by 1.

Mnemonic	Opcode	Description
SAR <i>reg/mem8</i> , 1	D0 /7	Shift a signed 8-bit register or memory operand right 1 bit.
SAR <i>reg/mem8</i> , CL	D2 /7	Shift a signed 8-bit register or memory operand right the number of bits specified in the CL register.
SAR <i>reg/mem8</i> , <i>imm8</i>	C0 /7 <i>ib</i>	Shift a signed 8-bit register or memory operand right the number of bits specified by an 8-bit immediate value.
SAR <i>reg/mem16</i> , 1	D1 /7	Shift a signed 16-bit register or memory operand right 1 bit.

Mnemonic	Opcode	Description
SAR <i>reg/mem16</i> , CL	D3 /7	Shift a signed 16-bit register or memory operand right the number of bits specified in the CL register.
SAR <i>reg/mem16</i> , <i>imm8</i>	C1 /7 <i>ib</i>	Shift a signed 16-bit register or memory operand right the number of bits specified by an 8-bit immediate value.
SAR <i>reg/mem32</i> , 1	D1 /7	Shift a signed 32-bit register or memory location 1 bit.
SAR <i>reg/mem32</i> , CL	D3 /7	Shift a signed 32-bit register or memory location right the number of bits specified in the CL register.
SAR <i>reg/mem32</i> , <i>imm8</i>	C1 /7 <i>ib</i>	Shift a signed 32-bit register or memory location right the number of bits specified by an 8-bit immediate value.
SAR <i>reg/mem64</i> , 1	D1 /7	Shift a signed 64-bit register or memory location right 1 bit.
SAR <i>reg/mem64</i> , CL	D3 /7	Shift a signed 64-bit register or memory location right the number of bits specified in the CL register.
SAR <i>reg/mem64</i> , <i>imm8</i>	C1 /7 <i>ib</i>	Shift a signed 64-bit register or memory location right the number of bits specified by an 8-bit immediate value.

Related Instructions

SAL, SHL, SHR, SHLD, SHRD

rFLAGS Affected

ID	VIP	VIF	AC	VM	RF	NT	IOPL	OF	DF	IF	TF	SF	ZF	AF	PF	CF
								M				M	M	U	M	M
21	20	19	18	17	16	14	13–12	11	10	9	8	7	6	4	2	0

Note: Bits 31–22, 15, 5, 3, and 1 are reserved. A flag set to 1 or cleared to 0 is M (modified). Unaffected flags are blank. Undefined flags are U.

Exceptions

Exception	Real	Virtual 8086	Protected	Cause of Exception
Stack, #SS	X	X	X	A memory address exceeded the stack segment limit or was non-canonical.
General protection, #GP	X	X	X	A memory address exceeded a data segment limit or was non-canonical.
			X	The destination operand was in a non-writable segment.
			X	A null data segment was used to reference memory.

Exception	Real	Virtual 8086	Protected	Cause of Exception
Page fault, #PF		X	X	A page fault resulted from the execution of the instruction.
Alignment check, #AC		X	X	An unaligned memory reference was performed while alignment checking was enabled.

SBB Subtract with Borrow

Subtracts an immediate value or the value in a register or a memory location (second operand) from a register or a memory location (first operand), and stores the result in the first operand location. If the carry flag (CF) is 1, the instruction subtracts 1 from the result. Otherwise, it operates like SUB.

The SBB instruction sign-extends immediate value operands to the length of the first operand size.

This instruction evaluates the result for both signed and unsigned data types and sets the OF and CF flags to indicate a borrow in a signed or unsigned result, respectively. It sets the SF flag to indicate the sign of a signed result.

This instruction is useful for multibyte (multiword) numbers because it takes into account the borrow from a previous SUB instruction.

The forms of the SBB instruction that write to memory support the LOCK prefix. For details about the LOCK prefix, see “Lock Prefix” on page 10.

Mnemonic	Opcode	Description
SBB AL, <i>imm8</i>	1C <i>ib</i>	Subtract an immediate 8-bit value from the AL register with borrow.
SBB AX, <i>imm16</i>	1D <i>iw</i>	Subtract an immediate 16-bit value from the AX register with borrow.
SBB EAX, <i>imm32</i>	1D <i>id</i>	Subtract an immediate 32-bit value from the EAX register with borrow.
SBB RAX, <i>imm32</i>	1D <i>id</i>	Subtract a sign-extended immediate 32-bit value from the RAX register with borrow.
SBB <i>reg/mem8</i> , <i>imm8</i>	80 /3 <i>ib</i>	Subtract an immediate 8-bit value from an 8-bit register or memory location with borrow.
SBB <i>reg/mem16</i> , <i>imm16</i>	81 /3 <i>iw</i>	Subtract an immediate 16-bit value from a 16-bit register or memory location with borrow.
SBB <i>reg/mem32</i> , <i>imm32</i>	81 /3 <i>id</i>	Subtract an immediate 32-bit value from a 32-bit register or memory location with borrow.
SBB <i>reg/mem64</i> , <i>imm32</i>	81 /3 <i>id</i>	Subtract a sign-extended immediate 32-bit value from a 64-bit register or memory location with borrow.

Mnemonic	Opcode	Description
SBB <i>reg/mem16, imm8</i>	83 /3 <i>ib</i>	Subtract a sign-extended 8-bit immediate value from a 16-bit register or memory location with borrow.
SBB <i>reg/mem32, imm8</i>	83 /3 <i>ib</i>	Subtract a sign-extended 8-bit immediate value from a 32-bit register or memory location with borrow.
SBB <i>reg/mem64, imm8</i>	83 /3 <i>ib</i>	Subtract a sign-extended 8-bit immediate value from a 64-bit register or memory location with borrow.
SBB <i>reg/mem8, reg8</i>	18 / <i>r</i>	Subtract the contents of an 8-bit register from an 8-bit register or memory location with borrow.
SBB <i>reg/mem16, reg16</i>	19 / <i>r</i>	Subtract the contents of a 16-bit register from a 16-bit register or memory location with borrow.
SBB <i>reg/mem32, reg32</i>	19 / <i>r</i>	Subtract the contents of a 32-bit register from a 32-bit register or memory location with borrow.
SBB <i>reg/mem64, reg64</i>	19 / <i>r</i>	Subtract the contents of a 64-bit register from a 64-bit register or memory location with borrow.
SBB <i>reg8, reg/mem8</i>	1A / <i>r</i>	Subtract the contents of an 8-bit register or memory location from the contents of an 8-bit register with borrow.
SBB <i>reg16, reg/mem16</i>	1B / <i>r</i>	Subtract the contents of a 16-bit register or memory location from the contents of a 16-bit register with borrow.
SBB <i>reg32, reg/mem32</i>	1B / <i>r</i>	Subtract the contents of a 32-bit register or memory location from the contents of a 32-bit register with borrow.
SBB <i>reg64, reg/mem64</i>	1B / <i>r</i>	Subtract the contents of a 64-bit register or memory location from the contents of a 64-bit register with borrow.

Related Instructions

SUB, ADD, ADC

rFLAGS Affected

ID	VIP	VIF	AC	VM	RF	NT	IOPL	OF	DF	IF	TF	SF	ZF	AF	PF	CF
								M				M	M	M	M	M
21	20	19	18	17	16	14	13–12	11	10	9	8	7	6	4	2	0

Note: Bits 31–22, 15, 5, 3, and 1 are reserved. A flag set to 1 or cleared to 0 is M (modified). Unaffected flags are blank. Undefined flags are U.

Exceptions

Exception	Real	Virtual 8086	Protected	Cause of Exception
Stack, #SS	X	X	X	A memory address exceeded the stack segment limit or was non-canonical.
General protection, #GP	X	X	X	A memory address exceeded a data segment limit or was non-canonical.
			X	The destination operand was in a non-writable segment.
			X	A null data segment was used to reference memory.
Page fault, #PF		X	X	A page fault resulted from the execution of the instruction.
Alignment check, #AC		X	X	An unaligned memory reference was performed while alignment checking was enabled.

SCAS Scan String

SCASB

SCASW

SCASD

SCASQ

Compares the AL, AX, EAX, or RAX register with the byte, word, doubleword, or quadword pointed to by ES:rDI, sets the status flags in the rFLAGS register according to the results, and then increments or decrements the rDI register according to the state of the DF flag in the rFLAGS register.

If the DF flag is 0, the instruction increments the rDI register; otherwise, it decrements it. The instruction increments or decrements the rDI register by 1, 2, 4, or 8, depending on the size of the operands.

The forms of the SCASx instruction with an explicit operand address the operand at ES:rDI. The explicit operand serves only to specify the size of the values being compared.

The no-operands forms of the instruction use the ES:rDI registers to point to the value to be compared. The mnemonic determines the size of the operands and the specific register containing the other comparison value.

For block comparisons, the SCASx instructions support the REPE or REPZ prefixes (they are synonyms) and the REPNE or REPNZ prefixes (they are synonyms). For details about the REP prefixes, see “Repeat Prefixes” on page 10. A SCASx instruction can also operate inside a loop controlled by the LOOPcc instruction.

Mnemonic	Opcode	Description
SCAS mem8	AE	Compare the contents of the AL register with the byte at ES:rDI, and then increment or decrement rDI.
SCAS mem16	AF	Compare the contents of the AX register with the word at ES:rDI, and then increment or decrement rDI.
SCAS mem32	AF	Compare the contents of the EAX register with the doubleword at ES:rDI, and then increment or decrement rDI.
SCAS mem64	AF	Compare the contents of the RAX register with the quadword at ES:rDI, and then increment or decrement rDI.

Mnemonic	Opcode	Description
SCASB	AE	Compare the contents of the AL register with the byte at ES:rDI, and then increment or decrement rDI.
SCASW	AF	Compare the contents of the AX register with the word at ES:rDI, and then increment or decrement rDI.
SCASD	AF	Compare the contents of the EAX register with the doubleword at ES:rDI, and then increment or decrement rDI.
SCASQ	AF	Compare the contents of the RAX register with the quadword at ES:rDI, and then increment or decrement rDI.

Related Instructions

CMP, CMPS_x

rFLAGS Affected

ID	VIP	VIF	AC	VM	RF	NT	IOPL	OF	DF	IF	TF	SF	ZF	AF	PF	CF
								M				M	M	M	M	M
21	20	19	18	17	16	14	13–12	11	10	9	8	7	6	4	2	0

Note: Bits 31–22, 15, 5, 3, and 1 are reserved. A flag set to 1 or cleared to 0 is M (modified). Unaffected flags are blank. Undefined flags are U.

Exceptions

Exception	Real	Virtual 8086	Protected	Cause of Exception
General protection, #GP			X	A null ES segment was used to reference memory.
	X	X	X	A memory address exceeded the ES segment limit or was non-canonical.
Page fault, #PF		X	X	A page fault resulted from the execution of the instruction.
Alignment check, #AC		X	X	An unaligned memory reference was performed while alignment checking was enabled.

SETcc Set Byte on Condition

Checks the status flags in the rFLAGS register and, if the flags meet the condition specified in the mnemonic (*cc*), sets the value in the specified 8-bit memory location or register to 1. If the flags do not meet the specified condition, SETcc clears the memory location or register to 0.

Mnemonics with the A (above) and B (below) tags are intended for use when performing unsigned integer comparisons; those with G (greater) and L (less) tags are intended for use with signed integer comparisons.

Software typically uses the SETcc instructions to set logical indicators. Like the CMOVcc instructions (page 103), the SETcc instructions can replace two instructions—a conditional jump and a move. Replacing conditional jumps with conditional sets can help avoid branch-prediction penalties that may result from conditional jumps.

If the logical value “true” (logical one) is represented in a high-level language as an integer with all bits set to 1, software can accomplish such representation by first executing the opposite SETcc instruction—for example, the opposite of SETZ is SETNZ—and then decrementing the result.

A ModR/M byte is used to identify the operand. The *reg* field in the ModR/M byte is unused.

Mnemonic	Opcode	Description
SETO <i>reg/mem8</i>	0F 90 /0	Set byte if overflow (OF = 1).
SETNO <i>reg/mem8</i>	0F 91 /0	Set byte if not overflow (OF = 0).
SETB <i>reg/mem8</i>	0F 92 /0	Set byte if below (CF = 1).
SETC <i>reg/mem8</i>		Set byte if carry (CF = 1).
SETNAE <i>reg/mem8</i>		Set byte if not above or equal (CF = 1).
SETNB <i>reg/mem8</i>	0F 93 /0	Set byte if not below (CF = 0).
SETNC <i>reg/mem8</i>		Set byte if not carry (CF = 0).
SETAE <i>reg/mem8</i>		Set byte if above or equal (CF = 0).
SETZ <i>reg/mem8</i>	0F 94 /0	Set byte if zero (ZF = 1).
SETE <i>reg/mem8</i>		Set byte if equal (ZF = 1).
SETNZ <i>reg/mem8</i>	0F 95 /0	Set byte if not zero (ZF = 0).
SETNE <i>reg/mem8</i>		Set byte if not equal (ZF = 0).

Mnemonic	Opcode	Description
SETBE <i>reg/mem8</i> SETNA <i>reg/mem8</i>	0F 96 /0	Set byte if below or equal (CF = 1 or ZF = 1). Set byte if not above (CF = 1 or ZF = 1).
SETNBE <i>reg/mem8</i> SETA <i>reg/mem8</i>	0F 97 /0	Set byte if not below or equal (CF = 0 and ZF = 0). Set byte if above (CF = 0 and ZF = 0).
SETS <i>reg/mem8</i>	0F 98 /0	Set byte if sign (SF = 1).
SETNS <i>reg/mem8</i>	0F 99 /0	Set byte if not sign (SF = 0).
SETP <i>reg/mem8</i> SETPE <i>reg/mem8</i>	0F 9A /0	Set byte if parity (PF = 1). Set byte if parity even (PF = 1).
SETNP <i>reg/mem8</i> SETPO <i>reg/mem8</i>	0F 9B /0	Set byte if not parity (PF = 0). Set byte if parity odd (PF = 0).
SETL <i>reg/mem8</i> SETNGE <i>reg/mem8</i>	0F 9C /0	Set byte if less (SF < OF). Set byte if not greater or equal (SF < OF).
SETNL <i>reg/mem8</i> SETGE <i>reg/mem8</i>	0F 9D /0	Set byte if not less (SF = OF). Set byte if greater or equal (SF = OF).
SETLE <i>reg/mem8</i> SETNG <i>reg/mem8</i>	0F 9E /0	Set byte if less or equal (ZF = 1 or SF < OF). Set byte if not greater (ZF = 1 or SF < OF).
SETNLE <i>reg/mem8</i> SETG <i>reg/mem8</i>	0F 9F /0	Set byte if not less or equal (ZF = 0 and SF = OF). Set byte if greater (ZF = 0 and SF = OF).

Related Instructions

None

rFLAGS Affected

None

Exceptions

Exception	Real	Virtual 8086	Protected	Cause of Exception
Stack, #SS	X	X	X	A memory address exceeded the stack segment limit or was non-canonical.

Exception	Real	Virtual 8086	Protected	Cause of Exception
General protection, #GP	X	X	X	A memory address exceeded a data segment limit or was non-canonical.
			X	The destination operand was in a non-writable segment.
			X	A null data segment was used to reference memory.
Page fault, #PF		X	X	A page fault resulted from the execution of the instruction.

SFENCE Store Fence

Acts as a barrier to force strong memory ordering (serialization) between store instructions preceding the SFENCE and store instructions that follow the SFENCE. A weakly-ordered memory system allows hardware to reorder reads and writes between the processor and memory. The SFENCE instruction guarantees that the system completes all previous stores before executing subsequent stores.

The SFENCE instruction is weakly-ordered with respect to load instructions, data and instruction prefetches, and the LFENCE instruction. Speculative loads initiated by the processor, or specified explicitly using cache-prefetch instructions, can be reordered around an SFENCE.

In addition to store instructions, SFENCE is strongly ordered with respect to other SFENCE instructions, MFENCE instructions, and serializing instructions.

Support for the SFENCE instruction is indicated when the SSE bit (bit 25) is set to 1 in EDX after executing CPUID standard function 1.

Mnemonic	Opcode	Description
SFENCE	0F AE F8	Force strong ordering of (serialized) store operations.

Related Instructions

LFENCE, MFENCE

rFLAGS Affected

None

Exceptions

Exception	Real	Virtual 8086	Protected	Cause of Exception
Invalid Opcode, #UD	X	X	X	The SSE instructions are not supported, as indicated by bit 25 in CPUID standard function 1; and the AMD extensions to MMX are not supported, as indicated by bit 22 of CPUID extended function 8000_0001h.

SHL **Shift Left**

This instruction is synonymous with the SAL instruction. For information, see “SAL SHL” on page 252.

SHLD Shift Left Double

Shifts the bits of a register or memory location (first operand) to the left by the number of bit positions in an unsigned immediate value or the CL register (third operand), and shifts in a bit pattern (second operand) from the right. At the end of the shift operation, the CF flag contains the last bit shifted out of the first operand.

The processor masks the upper three bits of the count operand, thus restricting the count to a number between 0 and 31. When the destination is 64 bits wide, the processor masks the upper two bits of the count, providing a count in the range of 0 to 63. If the masked count is greater than the operand size, the result in the destination register is undefined.

If the shift count is 0, no flags are modified.

If the count is 1 and the sign of the operand being shifted changes, the instruction sets the OF flag to 1. If the count is greater than 1, OF is undefined.

Mnemonic	Opcode	Description
SHLD <i>reg/mem16, reg16, imm8</i>	0F A4 /r <i>ib</i>	Shift bits of a 16-bit destination register or memory operand to the left the number of bits specified in an 8-bit immediate value, while shifting in bits from the second operand.
SHLD <i>reg/mem16, reg16, CL</i>	0F A5 /r	Shift bits of a 16-bit destination register or memory operand to the left the number of bits specified in the CL register, while shifting in bits from the second operand.
SHLD <i>reg/mem32, reg32, imm8</i>	0F A4 /r <i>ib</i>	Shift bits of a 32-bit destination register or memory operand to the left the number of bits specified in an 8-bit immediate value, while shifting in bits from the second operand.
SHLD <i>reg/mem32, reg32, CL</i>	0F A5 /r	Shift bits of a 32-bit destination register or memory operand to the left the number of bits specified in the CL register, while shifting in bits from the second operand.
SHLD <i>reg/mem64, reg64, imm8</i>	0F A4 /r <i>ib</i>	Shift bits of a 64-bit destination register or memory operand to the left the number of bits specified in an 8-bit immediate value, while shifting in bits from the second operand.
SHLD <i>reg/mem64, reg64, CL</i>	0F A5 /r	Shift bits of a 64-bit destination register or memory operand to the left the number of bits specified in the CL register, while shifting in bits from the second operand.

Related Instructions

SHRD, SAL, SAR, SHR, SHL

rFLAGS Affected

ID	VIP	VIF	AC	VM	RF	NT	IOPL	OF	DF	IF	TF	SF	ZF	AF	PF	CF
								M				M	M	U	M	M
21	20	19	18	17	16	14	13–12	11	10	9	8	7	6	4	2	0

Note: Bits 31–22, 15, 5, 3, and 1 are reserved. A flag set to 1 or cleared to 0 is M (modified). Unaffected flags are blank. Undefined flags are U.

Exceptions

Exception	Real	Virtual 8086	Protected	Cause of Exception
Stack, #SS	X	X	X	A memory address exceeded the stack segment limit or was non-canonical.
General protection, #GP	X	X	X	A memory address exceeded a data segment limit or was non-canonical.
			X	The destination operand was in a non-writable segment.
			X	A null data segment was used to reference memory.
Page fault, #PF		X	X	A page fault resulted from the execution of the instruction.
Alignment check, #AC		X	X	An unaligned memory reference was performed while alignment checking was enabled.

SHR Shift Right

Shifts the bits of a register or memory location (first operand) to the right through the CF bit by the number of bit positions in an unsigned immediate value or the CL register (second operand). The instruction discards bits shifted out of the CF flag. At the end of the shift operation, the CF flag contains the last bit shifted out of the first operand.

For each bit shift, the instruction clears the most-significant bit to 0.

The effect of this instruction is unsigned division by powers of two.

The processor masks the upper three bits of the count operand, thus restricting the count to a number between 0 and 31. When the destination is 64 bits wide, the processor masks the upper two bits of the count, providing a count in the range of 0 to 63.

For 1-bit shifts, the instruction sets the OF flag to the most-significant bit of the original value. If the count is greater than 1, the OF flag is undefined.

If the shift count is 0, no flags are modified.

Mnemonic	Opcode	Description
SHR <i>reg/mem8</i> , 1	D0 /5	Shift an 8-bit register or memory operand right 1 bit.
SHR <i>reg/mem8</i> , CL	D2 /5	Shift an 8-bit register or memory operand right the number of bits specified in the CL register.
SHR <i>reg/mem8</i> , <i>imm8</i>	C0 /5 <i>ib</i>	Shift an 8-bit register or memory operand right the number of bits specified by an 8-bit immediate value.
SHR <i>reg/mem16</i> , 1	D1 /5	Shift a 16-bit register or memory operand right 1 bit.
SHR <i>reg/mem16</i> , CL	D3 /5	Shift a 16-bit register or memory operand right the number of bits specified in the CL register.
SHR <i>reg/mem16</i> , <i>imm8</i>	C1 /5 <i>ib</i>	Shift a 16-bit register or memory operand right the number of bits specified by an 8-bit immediate value.
SHR <i>reg/mem32</i> , 1	D1 /5	Shift a 32-bit register or memory operand right 1 bit.
SHR <i>reg/mem32</i> , CL	D3 /5	Shift a 32-bit register or memory operand right the number of bits specified in the CL register.
SHR <i>reg/mem32</i> , <i>imm8</i>	C1 /5 <i>ib</i>	Shift a 32-bit register or memory operand right the number of bits specified by an 8-bit immediate value.

SHR <i>reg/mem64</i> , 1	D1 /5	Shift a 64-bit register or memory operand right 1 bit.
SHR <i>reg/mem64</i> , CL	D3 /5	Shift a 64-bit register or memory operand right the number of bits specified in the CL register.
SHR <i>reg/mem64</i> , <i>imm8</i>	C1 /5 <i>ib</i>	Shift a 64-bit register or memory operand right the number of bits specified by an 8-bit immediate value.

Related Instructions

SHL, SAL, SAR, SHLD, SHRD

rFLAGS Affected

ID	VIP	VIF	AC	VM	RF	NT	IOPL	OF	DF	IF	TF	SF	ZF	AF	PF	CF
								M				M	M	U	M	M
21	20	19	18	17	16	14	13–12	11	10	9	8	7	6	4	2	0

Note: Bits 31–22, 15, 5, 3, and 1 are reserved. A flag set to 1 or cleared to 0 is M (modified). Unaffected flags are blank. Undefined flags are U.

Exceptions

Exception	Real	Virtual 8086	Protected	Cause of Exception
Stack, #SS	X	X	X	A memory address exceeded the stack segment limit or was non-canonical.
General protection, #GP	X	X	X	The destination operand was in a non-writable segment.
			X	A null data segment was used to reference memory.
Page fault, #PF		X	X	A page fault resulted from the execution of the instruction.
Alignment check, #AC		X	X	An unaligned memory reference was performed while alignment checking was enabled.

SHRD Shift Right Double

Shifts the bits of a register or memory location (first operand) to the right by the number of bit positions in an unsigned immediate value or the CL register (third operand), and shifts in a bit pattern (second operand) from the left. At the end of the shift operation, the CF flag contains the last bit shifted out of the first operand.

The processor masks the upper three bits of the count operand, thus restricting the count to a number between 0 and 31. When the destination is 64 bits wide, the processor masks the upper two bits of the count, providing a count in the range of 0 to 63. If the masked count is greater than the operand size, the result in the destination register is undefined.

If the shift count is 0, no flags are modified.

If the count is 1 and the sign of the value being shifted changes, the instruction sets the OF flag to 1. If the count is greater than 1, the OF flag is undefined.

Mnemonic	Opcode	Description
SHRD <i>reg/mem16, reg16, imm8</i>	OF AC /r ib	Shift bits of a 16-bit destination register or memory operand to the right the number of bits specified in an 8-bit immediate value, while shifting in bits from the second operand.
SHRD <i>reg/mem16, reg16, CL</i>	OF AD /r	Shift bits of a 16-bit destination register or memory operand to the right the number of bits specified in the CL register, while shifting in bits from the second operand.
SHRD <i>reg/mem32, reg32, imm8</i>	OF AC /r ib	Shift bits of a 32-bit destination register or memory operand to the right the number of bits specified in an 8-bit immediate value, while shifting in bits from the second operand.
SHRD <i>reg/mem32, reg32, CL</i>	OF AD /r	Shift bits of a 32-bit destination register or memory operand to the right the number of bits specified in the CL register, while shifting in bits from the second operand.
SHRD <i>reg/mem64, reg64, imm8</i>	OF AC /r ib	Shift bits of a 64-bit destination register or memory operand to the right the number of bits specified in an 8-bit immediate value, while shifting in bits from the second operand.
SHRD <i>reg/mem64, reg64, CL</i>	OF AD /r	Shift bits of a 64-bit destination register or memory operand to the right the number of bits specified in the CL register, while shifting in bits from the second operand.

Related Instructions

SHLD, SHR, SHL, SAR, SAL

rFLAGS Affected

ID	VIP	VIF	AC	VM	RF	NT	IOPL	OF	DF	IF	TF	SF	ZF	AF	PF	CF
								M				M	M	U	M	M
21	20	19	18	17	16	14	13–12	11	10	9	8	7	6	4	2	0

Note: Bits 31–22, 15, 5, 3, and 1 are reserved. A flag set to 1 or cleared to 0 is M (modified). Unaffected flags are blank. Undefined flags are U.

Exceptions

Exception	Real	Virtual 8086	Protected	Cause of Exception
Stack, #SS	X	X	X	A memory address exceeded the stack segment limit or was non-canonical.
General protection, #GP	X	X	X	A memory address exceeded a data segment limit or was non-canonical.
			X	The destination operand was in a non-writable segment.
			X	A null data segment was used to reference memory.
Page fault, #PF		X	X	A page fault resulted from the execution of the instruction.
Alignment check, #AC		X	X	An unaligned memory reference was performed while alignment checking was enabled.

STC Set Carry Flag

Sets the carry flag (CF) in the rFLAGS register to one.

Mnemonic	Opcode	Description
STC	F9	Set the carry flag (CF) to one.

Related Instructions

CLC, CMC

rFLAGS Affected

ID	VIP	VIF	AC	VM	RF	NT	IOPL	OF	DF	IF	TF	SF	ZF	AF	PF	CF
																1
21	20	19	18	17	16	14	13–12	11	10	9	8	7	6	4	2	0
<i>Note: Bits 31–22, 15, 5, 3, and 1 are reserved. A flag set to 1 or cleared to 0 is M (modified). Unaffected flags are blank. Undefined flags are U.</i>																

Exceptions

None

STD Set Direction Flag

Set the direction flag (DF) in the rFLAGS register to 1. If the DF flag is 0, each iteration of a string instruction increments the data pointer (index registers rSI or rDI). If the DF flag is 1, the string instruction decrements the pointer. Use the CLD instruction before a string instruction to make the data pointer increment.

Mnemonic	Opcode	Description
STD	FD	Set the direction flag (DF) to one.

Related Instructions

CLD, INSt, LODSt, MOVSt, OUTSt, SCASx, STOSx, CMPSx

rFLAGS Affected

ID	VIP	VIF	AC	VM	RF	NT	IOPL	OF	DF	IF	TF	SF	ZF	AF	PF	CF
									1							
21	20	19	18	17	16	14	13–12	11	10	9	8	7	6	4	2	0
<i>Note: Bits 31–22, 15, 5, 3, and 1 are reserved. A flag set to 1 or cleared to 0 is M (modified). Unaffected flags are blank. Undefined flags are U.</i>																

Exceptions

None

STOS **Store String**

STOSB

STOSW

STOSD

STOSQ

Copies a byte, word, doubleword, or quadword from the AL, AX, EAX, or RAX registers to the memory location pointed to by ES:rDI and increments or decrements the rDI register according to the state of the DF flag in the rFLAGS register.

If the DF flag is 0, the instruction increments the pointer; otherwise, it decrements the pointer. It increments or decrements the pointer by 1, 2, 4, or 8, depending on the size of the value being copied.

The forms of the STOSx instruction with an explicit operand use the operand only to specify the type (size) of the value being copied.

The no-operands forms specify the type (size) of the value being copied with the mnemonic.

The STOSx instructions support the REP prefixes. For details about the REP prefixes, see “Repeat Prefixes” on page 10. The STOSx instructions can also operate inside a LOOPcc instruction.

Mnemonic	Opcode	Description
STOS <i>mem8</i>	AA	Store the contents of the AL register to ES:rDI, and then increment or decrement rDI.
STOS <i>mem16</i>	AB	Store the contents of the AX register to ES:rDI, and then increment or decrement rDI.
STOS <i>mem32</i>	AB	Store the contents of the EAX register to ES:rDI, and then increment or decrement rDI.
STOS <i>mem64</i>	AB	Store the contents of the RAX register to ES:rDI, and then increment or decrement rDI.
STOSB	AA	Store the contents of the AL register to ES:rDI, and then increment or decrement rDI.
STOSW	AB	Store the contents of the AX register to ES:rDI, and then increment or decrement rDI.

STOSD	AB	Store the contents of the EAX register to ES:rDI, and then increment or decrement rDI.
STOSQ	AB	Store the contents of the RAX register to ES:rDI, and then increment or decrement rDI.

Related Instructions

LODSx, MOVsx

rFLAGS Affected

None

Exceptions

Exception	Real	Virtual 8086	Protected	Cause of Exception
General protection, #GP	X	X	X	A memory address exceeded the ES segment limit or was non-canonical.
			X	The ES segment was a non-writable segment.
			X	A null ES segment was used to reference memory.
Page fault, #PF		X	X	A page fault resulted from the execution of the instruction.
Alignment check, #AC		X	X	An unaligned memory reference was performed while alignment checking was enabled.

SUB Subtract

Subtracts an immediate value or the value in a register or memory location (second operand) from a register or a memory location (first operand) and stores the result in the first operand location. An immediate value is sign-extended to the length of the first operand.

This instruction evaluates the result for both signed and unsigned data types and sets the OF and CF flags to indicate a borrow in a signed or unsigned result, respectively. It sets the SF flag to indicate the sign of a signed result.

The forms of the SUB instruction that write to memory support the LOCK prefix. For details about the LOCK prefix, see “Lock Prefix” on page 10.

Mnemonic	Opcode	Description
SUB AL, <i>imm8</i>	2C <i>ib</i>	Subtract an immediate 8-bit value from the AL register and store the result in AL.
SUB AX, <i>imm16</i>	2D <i>iw</i>	Subtract an immediate 16-bit value from the AX register and store the result in AX.
SUB EAX, <i>imm32</i>	2D <i>id</i>	Subtract an immediate 32-bit value from the EAX register and store the result in EAX.
SUB RAX, <i>imm32</i>	2D <i>id</i>	Subtract a sign-extended immediate 32-bit value from the RAX register and store the result in RAX.
SUB <i>reg/mem8</i> , <i>imm8</i>	80 /5 <i>ib</i>	Subtract an immediate 8-bit value from an 8-bit destination register or memory location.
SUB <i>reg/mem16</i> , <i>imm16</i>	81 /5 <i>iw</i>	Subtract an immediate 16-bit value from a 16-bit destination register or memory location.
SUB <i>reg/mem32</i> , <i>imm32</i>	81 /5 <i>id</i>	Subtract an immediate 32-bit value from a 32-bit destination register or memory location.
SUB <i>reg/mem64</i> , <i>imm32</i>	81 /5 <i>id</i>	Subtract a sign-extended immediate 32-bit value from a 64-bit destination register or memory location.
SUB <i>reg/mem16</i> , <i>imm8</i>	83 /5 <i>ib</i>	Subtract a sign-extended immediate 8-bit value from a 16-bit register or memory location.
SUB <i>reg/mem32</i> , <i>imm8</i>	83 /5 <i>ib</i>	Subtract a sign-extended immediate 8-bit value from a 32-bit register or memory location.
SUB <i>reg/mem64</i> , <i>imm8</i>	83 /5 <i>ib</i>	Subtract a sign-extended immediate 8-bit value from a 64-bit register or memory location.

Mnemonic	Opcode	Description
SUB <i>reg/mem8, reg8</i>	28/r	Subtract the contents of an 8-bit register from an 8-bit destination register or memory location.
SUB <i>reg/mem16, reg16</i>	29/r	Subtract the contents of a 16-bit register from a 16-bit destination register or memory location.
SUB <i>reg/mem32, reg32</i>	29/r	Subtract the contents of a 32-bit register from a 32-bit destination register or memory location.
SUB <i>reg/mem64, reg64</i>	29/r	Subtract the contents of a 64-bit register from a 64-bit destination register or memory location.
SUB <i>reg8, reg/mem8</i>	2A/r	Subtract the contents of an 8-bit register or memory operand from an 8-bit destination register.
SUB <i>reg16, reg/mem16</i>	2B/r	Subtract the contents of a 16-bit register or memory operand from a 16-bit destination register.
SUB <i>reg32, reg/mem32</i>	2B/r	Subtract the contents of a 32-bit register or memory operand from a 32-bit destination register.
SUB <i>reg64, reg/mem64</i>	2B/r	Subtract the contents of a 64-bit register or memory operand from a 64-bit destination register.

Related Instructions

ADC, ADD, SBB

rFLAGS Affected

ID	VIP	VIF	AC	VM	RF	NT	IOPL	OF	DF	IF	TF	SF	ZF	AF	PF	CF
								M				M	M	M	M	M
21	20	19	18	17	16	14	13–12	11	10	9	8	7	6	4	2	0
<p>Note: Bits 31–22, 15, 5, 3, and 1 are reserved. A flag set to 1 or cleared to 0 is M (modified). Unaffected flags are blank. Undefined flags are U.</p>																

Exceptions

Exception	Real	Virtual 8086	Protected	Cause of Exception
Stack, #SS	X	X	X	A memory address exceeded the stack segment limit or was non-canonical.
General protection, #GP	X	X	X	A memory address exceeded a data segment limit or was non-canonical.
			X	The destination operand was in a non-writable segment.
			X	A null data segment was used to reference memory.
Page fault, #PF		X	X	A page fault resulted from the execution of the instruction.
Alignment check, #AC		X	X	An unaligned memory reference was performed while alignment checking was enabled.

TEST**Test Bits**

Performs a bit-wise logical AND on the value in a register or memory location (first operand) with an immediate value or the value in a register (second operand) and sets the flags in the rFLAGS register based on the result. While the AND instruction changes the contents of the destination and the flag bits, the TEST instruction changes only the flag bits.

Mnemonic	Opcode	Description
TEST AL, <i>imm8</i>	A8 <i>ib</i>	AND an immediate 8-bit value with the contents of the AL register and set rFLAGS to reflect the result.
TEST AX, <i>imm16</i>	A9 <i>iw</i>	AND an immediate 16-bit value with the contents of the AX register and set rFLAGS to reflect the result.
TEST EAX, <i>imm32</i>	A9 <i>id</i>	AND an immediate 32-bit value with the contents of the EAX register and set rFLAGS to reflect the result.
TEST RAX, <i>imm32</i>	A9 <i>id</i>	AND a sign-extended immediate 32-bit value with the contents of the RAX register and set rFLAGS to reflect the result.
TEST <i>reg/mem8</i> , <i>imm8</i>	F6 /0 <i>ib</i>	AND an immediate 8-bit value with the contents of an 8-bit register or memory operand and set rFLAGS to reflect the result.
TEST <i>reg/mem16</i> , <i>imm16</i>	F7 /0 <i>iw</i>	AND an immediate 16-bit value with the contents of a 16-bit register or memory operand and set rFLAGS to reflect the result.
TEST <i>reg/mem32</i> , <i>imm32</i>	F7 /0 <i>id</i>	AND an immediate 32-bit value with the contents of a 32-bit register or memory operand and set rFLAGS to reflect the result.
TEST <i>reg/mem64</i> , <i>imm32</i>	F7 /0 <i>id</i>	AND a sign-extended immediate 32-bit value with the contents of a 64-bit register or memory operand and set rFLAGS to reflect the result.
TEST <i>reg/mem8</i> , <i>reg8</i>	84 / <i>r</i>	AND the contents of an 8-bit register with the contents of an 8-bit register or memory operand and set rFLAGS to reflect the result.
TEST <i>reg/mem16</i> , <i>reg16</i>	85 / <i>r</i>	AND the contents of a 16-bit register with the contents of a 16-bit register or memory operand and set rFLAGS to reflect the result.
TEST <i>reg/mem32</i> , <i>reg32</i>	85 / <i>r</i>	AND the contents of a 32-bit register with the contents of a 32-bit register or memory operand and set rFLAGS to reflect the result.
TEST <i>reg/mem64</i> , <i>reg64</i>	85 / <i>r</i>	AND the contents of a 64-bit register with the contents of a 64-bit register or memory operand and set rFLAGS to reflect the result.

Related Instructions

AND, CMP

rFLAGS Affected

ID	VIP	VIF	AC	VM	RF	NT	IOPL	OF	DF	IF	TF	SF	ZF	AF	PF	CF
								0				M	M	U	M	0
21	20	19	18	17	16	14	13–12	11	10	9	8	7	6	4	2	0

Note: Bits 31–22, 15, 5, 3, and 1 are reserved. A flag set to 1 or cleared to 0 is M (modified). Unaffected flags are blank. Undefined flags are U.

Exceptions

Exception	Real	Virtual 8086	Protected	Cause of Exception
Stack, #SS	X	X	X	A memory address exceeded the stack segment limit or was non-canonical.
General protection, #GP	X	X	X	The destination operand was in a non-writable segment.
			X	A null data segment was used to reference memory.
Page fault, #PF		X	X	A page fault resulted from the execution of the instruction.
Alignment check, #AC		X	X	An unaligned memory reference was performed while alignment checking was enabled.

XADD Exchange and Add

Exchanges the contents of a register (second operand) with the contents of a register or memory location (first operand), computes the sum of the two values, and stores the result in the first operand location.

The forms of the XADD instruction that write to memory support the LOCK prefix. For details about the LOCK prefix, see “Lock Prefix” on page 10.

Mnemonic	Opcode	Description
XADD <i>reg/mem8, reg8</i>	0F C0 /r	Exchange the contents of an 8-bit register with the contents of an 8-bit destination register or memory operand and load their sum into the destination.
XADD <i>reg/mem16, reg16</i>	0F C1 /r	Exchange the contents of a 16-bit register with the contents of a 16-bit destination register or memory operand and load their sum into the destination.
XADD <i>reg/mem32, reg32</i>	0F C1 /r	Exchange the contents of a 32-bit register with the contents of a 32-bit destination register or memory operand and load their sum into the destination.
XADD <i>reg/mem64, reg64</i>	0F C1 /r	Exchange the contents of a 64-bit register with the contents of a 64-bit destination register or memory operand and load their sum into the destination.

Related Instructions

None

rFLAGS Affected

ID	VIP	VIF	AC	VM	RF	NT	IOPL	OF	DF	IF	TF	SF	ZF	AF	PF	CF
								M				M	M	M	M	M
21	20	19	18	17	16	14	13–12	11	10	9	8	7	6	4	2	0

Note: Bits 31–22, 15, 5, 3, and 1 are reserved. A flag set to 1 or cleared to 0 is M (modified). Unaffected flags are blank. Undefined flags are U.

Exceptions

Exception	Real	Virtual 8086	Protected	Cause of Exception
Stack, #SS	X	X	X	A memory address exceeded the stack segment limit or was non-canonical.
General protection, #GP	X	X	X	A memory address exceeded a data segment limit or was non-canonical.
			X	The destination operand was in a non-writable segment.
			X	A null data segment was used to reference memory.
Page fault, #PF		X	X	A page fault resulted from the execution of the instruction.
Alignment check, #AC		X	X	An unaligned memory reference was performed while alignment checking was enabled.

XCHG Exchange

Exchanges the contents of the two operands. The operands can be two general-purpose registers or a register and a memory location. If either operand references memory, the processor locks automatically, whether or not the LOCK prefix is used and independently of the value of IOPL. For details about the LOCK prefix, see “Lock Prefix” on page 10.

The x86 architecture commonly uses the XCHG EAX, EAX instruction (opcode 90h) as a one-byte NOP. In 64-bit mode, the processor treats opcode 90h as a true NOP only if it would exchange rAX with itself. Without this special handling, the instruction would zero-extend the upper 32 bits of RAX, and thus it would not be a true no-operation. Opcode 90h can still be used to exchange rAX and r8 if the appropriate REX prefix is used.

This special handling does not apply to the two-byte ModRM form of the XCHG instruction.

Mnemonic	Opcode	Description
XCHG AX, <i>reg16</i>	90 <i>+rw</i>	Exchange the contents of the AX register with the contents of a 16-bit register.
XCHG <i>reg16</i> , AX	90 <i>+rw</i>	Exchange the contents of a 16-bit register with the contents of the AX register.
XCHG EAX, <i>reg32</i>	90 <i>+rd</i>	Exchange the contents of the EAX register with the contents of a 32-bit register.
XCHG <i>reg32</i> , EAX	90 <i>+rd</i>	Exchange the contents of a 32-bit register with the contents of the EAX register.
XCHG RAX, <i>reg64</i>	90 <i>+rq</i>	Exchange the contents of the RAX register with the contents of a 64-bit register.
XCHG <i>reg64</i> , RAX	90 <i>+rq</i>	Exchange the contents of a 64-bit register with the contents of the RAX register.
XCHG <i>reg/mem8</i> , <i>reg8</i>	86 <i>/r</i>	Exchange the contents of an 8-bit register with the contents of an 8-bit register or memory operand.
XCHG <i>reg8</i> , <i>reg/mem8</i>	86 <i>/r</i>	Exchange the contents of an 8-bit register or memory operand with the contents of an 8-bit register.
XCHG <i>reg/mem16</i> , <i>reg16</i>	87 <i>/r</i>	Exchange the contents of a 16-bit register with the contents of a 16-bit register or memory operand.

Mnemonic	Opcode	Description
XCHG <i>reg16, reg/mem16</i>	87 /r	Exchange the contents of a 16-bit register or memory operand with the contents of a 16-bit register.
XCHG <i>reg/mem32, reg32</i>	87 /r	Exchange the contents of a 32-bit register with the contents of a 32-bit register or memory operand.
XCHG <i>reg32, reg/mem32</i>	87 /r	Exchange the contents of a 32-bit register or memory operand with the contents of a 32-bit register.
XCHG <i>reg/mem64, reg64</i>	87 /r	Exchange the contents of a 64-bit register with the contents of a 64-bit register or memory operand.
XCHG <i>reg64, reg/mem64</i>	87 /r	Exchange the contents of a 64-bit register or memory operand with the contents of a 64-bit register.

Related Instructions

BSWAP, XADD

rFLAGS Affected

None

Exceptions

Exception	Real	Virtual 8086	Protected	Cause of Exception
Stack, #SS	X	X	X	A memory address exceeded the stack segment limit or was non-canonical.
General protection, #GP	X	X	X	The source or destination operand was in a non-writable segment.
			X	A null data segment was used to reference memory.
Page fault, #PF		X	X	A page fault resulted from the execution of the instruction.
Alignment check, #AC		X	X	An unaligned memory reference was performed while alignment checking was enabled.

XLAT XLATB

Translate Table Index

Uses the unsigned integer in the AL register as an offset into a table and copies the contents of the table entry at that location to the AL register.

The instruction uses *seg:[rBX]* as the base address of the table. The value of *seg* defaults to the DS segment, but may be overridden by a segment prefix.

This instruction writes AL without changing RAX[63:8]. This instruction ignores operand size.

The single-operand form of the XLAT instruction uses the operand to document the segment and address size attribute, but it uses the base address specified by the rBX register.

This instruction is often used to translate data from one format (such as ASCII) to another (such as EBCDIC).

Mnemonic	Opcode	Description
XLAT <i>mem8</i>	D7	Set AL to the contents of DS:[rBX + unsigned AL].
XLATB	D7	Set AL to the contents of DS:[rBX + unsigned AL].

Related Instructions

None

rFLAGS Affected

None

Exceptions

Exception	Real	Virtual 8086	Protected	Cause of Exception
Stack, #SS	X	X	X	A memory address exceeded the stack segment limit or was non-canonical.

Exception	Real	Virtual 8086	Protected	Cause of Exception
General protection, #GP	X	X	X	A memory address exceeded a data segment limit or was non-canonical.
			X	A null data segment was used to reference memory.
Page fault, #PF		X	X	A page fault resulted from the execution of the instruction.

XOR Logical Exclusive OR

Performs a bitwise exclusive OR operation on both operands and stores the result in the first operand location. The first operand can be a register or memory location. The second operand can be an immediate value, a register, or a memory location. XOR-ing a register with itself clears the register.

The forms of the XOR instruction that write to memory support the LOCK prefix. For details about the LOCK prefix, see “Lock Prefix” on page 10.

The instruction performs the following operation for each bit:

X	Y	X XOR Y
0	0	0
0	1	1
1	0	1
1	1	0

Mnemonic	Opcode	Description
XOR AL, <i>imm8</i>	34 <i>ib</i>	XOR the contents of AL with an immediate 8-bit operand and store the result in AL.
XOR AX, <i>imm16</i>	35 <i>iw</i>	XOR the contents of AX with an immediate 16-bit operand and store the result in AX.
XOR EAX, <i>imm32</i>	35 <i>id</i>	XOR the contents of EAX with an immediate 32-bit operand and store the result in EAX.
XOR RAX, <i>imm32</i>	35 <i>id</i>	XOR the contents of RAX with a sign-extended immediate 32-bit operand and store the result in RAX.
XOR <i>reg/mem8</i> , <i>imm8</i>	80 /6 <i>ib</i>	XOR the contents of an 8-bit destination register or memory operand with an 8-bit immediate value and store the result in the destination.
XOR <i>reg/mem16</i> , <i>imm16</i>	81 /6 <i>iw</i>	XOR the contents of a 16-bit destination register or memory operand with a 16-bit immediate value and store the result in the destination.

Mnemonic	Opcode	Description
XOR <i>reg/mem32, imm32</i>	81 /6 <i>id</i>	XOR the contents of a 32-bit destination register or memory operand with a 32-bit immediate value and store the result in the destination.
XOR <i>reg/mem64, imm32</i>	81 /6 <i>id</i>	XOR the contents of a 64-bit destination register or memory operand with a sign-extended 32-bit immediate value and store the result in the destination.
XOR <i>reg/mem16, imm8</i>	83 /6 <i>ib</i>	XOR the contents of a 16-bit destination register or memory operand with a sign-extended 8-bit immediate value and store the result in the destination.
XOR <i>reg/mem32, imm8</i>	83 /6 <i>ib</i>	XOR the contents of a 32-bit destination register or memory operand with a sign-extended 8-bit immediate value and store the result in the destination.
XOR <i>reg/mem64, imm8</i>	83 /6 <i>ib</i>	XOR the contents of a 64-bit destination register or memory operand with a sign-extended 8-bit immediate value and store the result in the destination.
XOR <i>reg/mem8, reg8</i>	30 / <i>r</i>	XOR the contents of an 8-bit destination register or memory operand with the contents of an 8-bit register and store the result in the destination.
XOR <i>reg/mem16, reg16</i>	31 / <i>r</i>	XOR the contents of a 16-bit destination register or memory operand with the contents of a 16-bit register and store the result in the destination.
XOR <i>reg/mem32, reg32</i>	31 / <i>r</i>	XOR the contents of a 32-bit destination register or memory operand with the contents of a 32-bit register and store the result in the destination.
XOR <i>reg/mem64, reg64</i>	31 / <i>r</i>	XOR the contents of a 64-bit destination register or memory operand with the contents of a 64-bit register and store the result in the destination.
XOR <i>reg8, reg/mem8</i>	32 / <i>r</i>	XOR the contents of an 8-bit destination register with the contents of an 8-bit register or memory operand and store the results in the destination.
XOR <i>reg16, reg/mem16</i>	33 / <i>r</i>	XOR the contents of a 16-bit destination register with the contents of a 16-bit register or memory operand and store the results in the destination.
XOR <i>reg32, reg/mem32</i>	33 / <i>r</i>	XOR the contents of a 32-bit destination register with the contents of a 32-bit register or memory operand and store the results in the destination.
XOR <i>reg64, reg/mem64</i>	33 / <i>r</i>	XOR the contents of a 64-bit destination register with the contents of a 64-bit register or memory operand and store the results in the destination.

Related Instructions

OR, AND, NOT, NEG

rFLAGS Affected

ID	VIP	VIF	AC	VM	RF	NT	IOPL	OF	DF	IF	TF	SF	ZF	AF	PF	CF
								0				M	M	U	M	0
21	20	19	18	17	16	14	13–12	11	10	9	8	7	6	4	2	0

Note: Bits 31–22, 15, 5, 3, and 1 are reserved. A flag set to 1 or cleared to 0 is M (modified). Unaffected flags are blank. Undefined flags are U.

Exceptions

Exception	Real	Virtual 8086	Protected	Cause of Exception
Stack, #SS	X	X	X	A memory address exceeded the stack segment limit or was non-canonical.
General protection, #GP	X	X	X	A memory address exceeded a data segment limit or was non-canonical.
			X	The destination operand was in a non-writable segment.
			X	A null data segment was used to reference memory.
Page fault, #PF		X	X	A page fault resulted from the execution of the instruction.
Alignment check, #AC		X	X	An unaligned memory reference was performed while alignment checking was enabled.

4 System Instruction Reference

This chapter describes the function, mnemonic syntax, opcodes, affected flags, and possible exceptions generated by the system instructions. The system instructions are used to establish the operating mode, access processor resources, handle program and system errors, and manage memory. Many of these instructions can only be executed by privileged software, such as the operating system kernel and interrupt handlers, that run at the highest privilege level. Only system instructions can access certain processor resources, such as the control registers, model-specific registers, and debug registers.

System instructions are supported in all hardware implementations of the AMD64 architecture, except that the following system instructions are implemented only if their associated CPUID function bits are set:

- RDMSR and WRMSR, indicated by bit 5 of CPUID standard function 1 or extended function 8000_0001h.
- SYSENTER and SYSEXIT, indicated by bit 11 of CPUID standard function 1.
- SYSCALL and SYSRET, indicated by bit 11 of CPUID extended function 8000_0001h.
- Long Mode instructions, indicated by bit 29 of CPUID extended function 8000_0001h.

There are also several other CPUID function bits that control the use of system resources and functions, such as paging functions, virtual-mode extensions, machine-check exceptions, advanced programmable interrupt control (APIC), memory-type range registers (MTRRs), etc. For details, see “Processor Feature Identification” in Volume 2.

For further information about the system instructions and register resources, see:

- “System-Management Instructions” in Volume 2.
- “Summary of Registers and Data Types” on page 30.
- “Notation” on page 43.
- “Instruction Prefixes” on page 3.

ARPL Adjust Requestor Privilege Level

Compares the requestor privilege level (RPL) fields of two segment selectors in the source and destination operands of the instruction. If the RPL field of the destination operand is less than the RPL field of the segment selector in the source register, then the zero flag is set and the RPL field of the destination operand is increased to match that of the source operand. Otherwise, the destination operand remains unchanged and the zero flag is cleared.

The destination operand can be either a 16-bit register or memory location; the source operand must be a 16-bit register.

The ARPL instruction is intended for use by operating-system procedures to adjust the RPL of a segment selector that has been passed to the operating system by an application program to match the privilege level of the application program. The segment selector passed to the operating system is placed in the destination operand and the segment selector for the code segment of the application program is placed in the source operand. The RPL field in the source operand represents the privilege level of the application program. The ARPL instruction then insures that the RPL of the segment selector received by the operating system is no lower than the privilege level of the application program.

See “Adjusting Access Rights” in Volume 2, for more information on access rights.

In 64-bit mode, this opcode (63H) is used for the MOVSSXD instruction.

Mnemonic	Opcode	Description
ARPL <i>reg/mem16, reg16</i>	63/r	Adjust the RPL of a destination segment selector to a level not less than the RPL of the segment selector specified in the 16-bit source register. (Invalid in 64-bit mode.)

Related Instructions

LAR, LSL, VERR, VERW

rFLAGS Affected

ID	VIP	VIF	AC	VM	RF	NT	IOPL	OF	DF	IF	TF	SF	ZF	AF	PF	CF
													M			
21	20	19	18	17	16	14	13–12	11	10	9	8	7	6	4	2	0

Note: Bits 31–22, 15, 5, 3, and 1 are reserved. A flag set to one or cleared to zero is M (modified). Unaffected flags are blank. Undefined flags are U.

Exceptions

Exception	Real	Virtual 8086	Protected	Cause of Exception
Invalid opcode, #UD	X	X		This instruction is only recognized in protected legacy and compatibility mode.
Stack, #SS			X	A memory address exceeded the stack segment limit.
General protection, #GP			X	A memory address exceeded a data segment limit.
			X	The destination operand was in a non-writable segment.
			X	A null segment selector was used to reference memory.
Page fault, #PF			X	A page fault resulted from the execution of the instruction.
Alignment check, #AC			X	An unaligned memory reference was performed while alignment checking was enabled.

CLI Clear Interrupt Flag

Clears the interrupt flag (IF) in the rFLAGS register to zero, thereby masking external interrupts received on the INTR input. Interrupts received on the non-maskable interrupt (NMI) input are not affected by this instruction.

In real mode, this instruction clears IF to 0.

In protected mode and virtual-8086-mode, this instruction is IOPL-sensitive. If the CPL is less than or equal to the rFLAGS.IOPL field, the instruction clears IF to 0.

In protected mode, if $IOPL < 3$, $CPL = 3$, and protected mode virtual interrupts are enabled ($CR4.PVI = 1$), then the instruction instead clears rFLAGS.VIF to 0. If none of these conditions apply, the processor raises a general-purpose exception (#GP). For more information, see “Protected Mode Virtual Interrupts” in Volume 2.

In virtual-8086 mode, if $IOPL < 3$ and the virtual-8086-mode extensions are enabled ($CR4.VME = 1$), the CLI instruction clears the virtual interrupt flag (rFLAGS.VIF) to 0 instead.

See “Virtual-8086 Mode Extensions” in Volume 2 for more information about IOPL-sensitive instructions.

Mnemonic	Opcode	Description
CLI	FA	Clear the interrupt flag (IF) to zero.

Action

```
IF (CPL <= IOPL)
    RFLAGS.IF = 0

ELSEIF (((VIRTUAL_MODE) && (CR4.VME = 1))
        || ((PROTECTED_MODE) && (CR4.PVI = 1) && (CPL == 3)))
    RFLAGS.VIF = 0;

ELSE
    EXCEPTION[#GP(0)]
```

Related Instructions

STI

rFLAGS Affected

ID	VIP	VIF	AC	VM	RF	NT	IOPL	OF	DF	IF	TF	SF	ZF	AF	PF	CF
		M								M						
21	20	19	18	17	16	14	13–12	11	10	9	8	7	6	4	2	0

Note: Bits 31–22, 15, 5, 3, and 1 are reserved. A flag set to one or cleared to zero is M (modified). Unaffected flags are blank. Undefined flags are U.

Exceptions

Exception	Real	Virtual 8086	Protected	Cause of Exception
General protection, #GP		X		The CPL was greater than the IOPL and virtual mode extensions are not enabled (CR4.VME = 0).
			X	The CPL was greater than the IOPL and either the CPL was not 3 or protected mode virtual interrupts were not enabled (CR4.PVI = 0).

CLTS**Clear Task-Switched Flag in CR0**

Clears the task-switched (TS) flag in the CR0 register to 0. The processor sets the TS flag on each task switch. The CLTS instruction is intended to facilitate the synchronization of FPU context saves during multitasking operations.

This instruction can only be used if the current privilege level is 0.

See “System-Control Registers” in Volume 2 for more information on FPU synchronization and the TS flag.

Mnemonic	Opcode	Description
CLTS	OF 06	Clear the task-switched (TS) flag in CR0 to 0.

Related Instructions

LMSW, MOV (CR n)

rFLAGS Affected

None

Exceptions

Exception	Real	Virtual 8086	Protected	Cause of Exception
General protection, #GP		X	X	CPL was not 0.

HLT**Halt**

Causes the microprocessor to halt instruction execution and enter the HALT state. Entering the HALT state puts the processor in low-power mode. Execution resumes when an unmasked hardware interrupt (INTR), non-maskable interrupt (NMI), system management interrupt (SMI), RESET, or INIT occurs.

If an INTR, NMI, or SMI is used to resume execution after a HLT instruction, the saved instruction pointer points to the instruction following the HLT instruction.

Before executing a HLT instruction, hardware interrupts should be enabled. If rFLAGS.IF = 0, the system will remain in a HALT state until an NMI, SMI, RESET, or INIT occurs.

If an SMI brings the processor out of the HALT state, the SMI handler can decide whether to return to the HALT state or not. See Volume 2, *System Programming*, for information on SMIs.

Current privilege level must be 0 to execute this instruction.

Mnemonic	Opcode	Description
HLT	F4	Halt instruction execution.

Related Instructions

STI, CLI

rFLAGS Affected

None

Exceptions

Exception	Real	Virtual 8086	Protected	Cause of Exception
General protection, #GP		X	X	CPL was not 0.

INT 3 Interrupt to Debug Vector

Calls the debug exception handler. This instruction maps to a 1-byte opcode (CC) that raises a #BP exception. The INT 3 instruction is normally used by debug software to set instruction breakpoints by replacing the first byte of the instruction opcode bytes with the INT 3 opcode.

This one-byte INT 3 instruction behaves differently from the two-byte INT 3 instruction (opcode CD 03) (see “INT” in Chapter 3 “General Purpose Instructions” for further information) in two ways:

- The #BP exception is handled without any IOPL checking in virtual x86 mode. (IOPL mismatches will not trigger an exception.)
- In VME mode, the #BP exception is not redirected via the interrupt redirection table. (Instead, it is handled by a protected mode handler.)

Mnemonic	Opcode	Description
INT 3	CC	Trap to debugger at Interrupt 3.

For complete descriptions of the steps performed by INT instructions, see the following:

- *Legacy-Mode Interrupts*: “Legacy Protected-Mode Interrupt Control Transfers” in Volume 2.
- *Long-Mode Interrupts*: “Long-Mode Interrupt Control Transfers” in Volume 2.

Action

```
// Refer to INT instruction's Action section for the details on INT_N_REAL,
// INT_N_PROTECTED, and INT_N_VIRTUAL_TO_PROTECTED.
INT3_START:
```

```
If (REAL_MODE)
    INT_N_REAL //N = 3

ELSEIF (PROTECTED_MODE)
    INT_N_PROTECTED //N = 3

ELSE // VIRTUAL_MODE
    INT_N_VIRTUAL_TO_PROTECTED //N = 3
```

Related Instructions

INT, INTO, IRET

rFLAGS Affected

If a task switch occurs, all flags are modified; otherwise, settings are as follows:

ID	VIP	VIF	AC	VM	RF	NT	IOPL	OF	DF	IF	TF	SF	ZF	AF	PF	CF
			M	0	0	M				M	0					
21	20	19	18	17	16	14	13–12	11	10	9	8	7	6	4	2	0

Note: Bits 31–22, 15, 5, 3, and 1 are reserved. A flag set to one or cleared to zero is M (modified). Unaffected flags are blank. Undefined flags are U.

Exceptions

Exception	Real	Virtual 8086	Protected	Cause of Exception
Breakpoint, #BP	X	X	X	INT 3 instruction was executed.
Invalid TSS, #TS (selector)		X	X	As part of a stack switch, the target stack segment selector or rSP in the TSS was that was beyond the TSS limit.
		X	X	As part of a stack switch, the target stack segment selector in the TSS was beyond the limit of the GDT or LDT descriptor table.
		X	X	As part of a stack switch, the target stack segment selector in the TSS was a null selector.
		X	X	As part of a stack switch, the target stack segment selector's TI bit was set, but the LDT selector was a null selector.
		X	X	As part of a stack switch, the target stack segment selector in the TSS contained a RPL that was not equal to its DPL.
		X	X	As part of a stack switch, the target stack segment selector in the TSS contained a DPL that was not equal to the CPL of the code segment selector.
Segment not present, #NP (selector)		X	X	The accessed code segment, interrupt gate, trap gate, task gate, or TSS was not present.
Stack, #SS	X	X	X	A memory address exceeded the stack segment limit or was non-canonical.

Exception	Real	Virtual 8086	Protected	Cause of Exception
Stack, #SS (selector)		X	X	After a stack switch, a memory address exceeded the stack segment limit or was non-canonical and a stack switch occurred.
		X	X	As part of a stack switch, the SS register was loaded with a non-null segment selector and the segment was marked not present.
General protection, #GP	X	X	X	A memory address exceeded the data segment limit or was non-canonical.
	X	X	X	The target offset exceeded the code segment limit or was non-canonical.
General protection, #GP (selector)	X	X	X	The interrupt vector was beyond the limit of IDT.
		X	X	The descriptor in the IDT was not an interrupt, trap, or task gate in legacy mode or not a 64-bit interrupt or trap gate in long mode.
		X	X	The DPL of the interrupt, trap, or task gate descriptor was less than the CPL.
		X	X	The segment selector specified by the interrupt or trap gate had its TI bit set, but the LDT selector was a null selector.
		X	X	The segment descriptor specified by the interrupt or trap gate exceeded the descriptor table limit or was a null selector.
		X	X	The segment descriptor specified by the interrupt or trap gate was not a code segment in legacy mode, or not a 64-bit code segment in long mode.
		X	X	The DPL of the segment specified by the interrupt or trap gate was greater than the CPL.
	X	X	The DPL of the segment specified by the interrupt or trap gate pointed was not 0 or it was a conforming segment.	
Page fault, #PF		X	X	A page fault resulted from the execution of the instruction.
Alignment check, #AC		X	X	An unaligned memory reference was performed while alignment checking was enabled.

INVD Invalidate Caches

Invalidates internal caches (data cache, instruction cache, and on-chip L2 cache) and triggers a bus cycle that causes external caches to invalidate themselves as well.

No data is written back to main memory from invalidating internal caches. After invalidating internal caches, the processor proceeds immediately with the execution of the next instruction without waiting for external hardware to invalidate its caches.

This is a privileged instruction. The current privilege level (CPL) of a procedure invalidating the processor's internal caches must be 0.

To insure that data is written back to memory prior to invalidating caches, use the WBINVD instruction.

This instruction does not invalidate TLB caches.

INVD is a serializing instruction.

Mnemonic	Opcode	Description
INVD	0F 08	Flush internal caches and trigger external cache flushes.

Related Instructions

WBINVD, CLFLUSH

rFLAGS Affected

None

Exceptions

Exception	Real	Virtual 8086	Protected	Cause of Exception
General protection, #GP		X	X	CPL was not 0.

INVLPG Invalidate TLB Entry

Invalidates the TLB entry that would be used for the 1-byte memory operand.

This instruction invalidates the TLB entry, regardless of the G (Global) bit setting in the associated PDE or PTE entry and regardless of the page size (4 Kbytes, 2 Mbytes, or 4 Mbytes). It may invalidate any number of additional TLB entries, in addition to the targeted entry.

INVLPG is a serializing instruction and a privileged instruction. The current privilege level must be 0 to execute this instruction.

See “Page Translation and Protection” in Volume 2 for more information on page translation.

Mnemonic	Opcode	Description
INVLPG <i>mem8</i>	0F 01 /7	Invalidate the TLB entry for the page containing a specified memory location.

Related Instructions

MOV CR_n (CR3 and CR4)

rFLAGS Affected

None

Exceptions

Exception	Real	Virtual 8086	Protected	Cause of Exception
General protection, #GP		X	X	CPL was not 0.

IRET

IRETD

IRETQ

Return from Interrupt

Returns program control from an exception or interrupt handler to a program or procedure previously interrupted by an exception, an external interrupt, or a software-generated interrupt. These instructions also perform a return from a nested task. All flags, CS, and RIP are restored to the values they had before the interrupt so that execution may continue at the next instruction following the interrupt or exception. In 64-bit mode or if the CPL changes, SS and RSP are also restored.

IRET, IRETD, and IRETQ are synonyms mapping to the same opcode. They are intended to provide semantically distinct forms for various opcode sizes. The IRET instruction is used for 16-bit operand size; IRETD is used for 32-bit operand sizes; IRETQ is used for 64-bit operands. The latter form is only meaningful in 64-bit mode.

IRET, IRETD, or IRETQ must be used to terminate the exception or interrupt handler associated with the exception, external interrupt, or software-generated interrupt.

IRETx is a serializing instruction.

For detailed descriptions of the steps performed by IRETx instructions, see the following:

- *Legacy-Mode Interrupts*: “Legacy Protected-Mode Interrupt Control Transfers” in Volume 2.
- *Long-Mode Interrupts*: “Long-Mode Interrupt Control Transfers” in Volume 2.

Mnemonic	Opcode	Description
IRET	CF	Return from interrupt (16-bit operand size).
IRETD	CF	Return from interrupt (32-bit operand size).
IRETQ	CF	Return from interrupt (64-bit operand size).

Action

IRET_START:

```
IF (REAL_MODE)
    IRET_REAL
ELSIF (PROTECTED_MODE)
```

```

    IRET_PROTECTED
ELSE // (VIRTUAL_MODE)
    IRET_VIRTUAL

```

```
IRET_REAL:
```

```

    POP.v temp_RIP
    POP.v temp_CS
    POP.v temp_RFLAGS

    IF (temp_RIP > CS.limit)
        EXCEPTION [#GP(0)]

    CS.sel = temp_CS
    CS.base = temp_CS SHL 4

    RFLAGS.v = temp_RFLAGS // VIF,VIP,VM unchanged
    RIP = temp_RIP
    EXIT

```

```
IRET_PROTECTED:
```

```

    IF (RFLAGS.NT=1) // iret does a task-switch to a previous task
        IF (LEGACY_MODE)
            TASK_SWITCH // using the 'back link' field in the tss
        ELSE // (LONG_MODE)
            EXCEPTION [#GP(0)] // task switches aren't supported in long mode

    POP.v temp_RIP
    POP.v temp_CS
    POP.v temp_RFLAGS

    IF ((temp_RFLAGS.VM=1) && (CPL=0) && (LEGACY_MODE))
        IRET_FROM_PROTECTED_TO_VIRTUAL

    temp_CPL = temp_CS.rpl

    IF ((64BIT_MODE) || (temp_CPL!=CPL))
    {
        POP.v temp_RSP // in 64-bit mode, iret always pops ss:rsp
        POP.v temp_SS
    }

    CS = READ_DESCRIPTOR (temp_CS, iret_chk)

    IF ((64BIT_MODE) && (temp_RIP is non-canonical)
        || (!64BIT_MODE) && (temp_RIP > CS.limit))
    {
        EXCEPTION [#GP(0)]
    }

```



```

}

CPL = temp_CPL

IF ((started in 64-bit mode) || (changing CPL))
    // ss:rsp were popped, so load them into the registers
{
    SS = READ_DESCRIPTOR (temp_SS, ss_chk)
    RSP.s = temp_RSP
}

IF (changing CPL)
{
    FOR (seg = ES, DS, FS, GS)
        IF ((seg.attr.dpl < CPL) && ((seg.attr.type = 'data')
            || (seg.attr.type = 'non-conforming-code')))
        {
            seg = NULL // can't use lower dpl data segment at higher cpl
        }
}
RFLAGS.v = temp_RFLAGS // VIF,VIP,IOPL only changed if (old_CPL=0)
// IF only changed if (old_CPL<=old_RFLAGS.IOPL)
// VM unchanged
// RF cleared

RIP = temp_RIP
EXIT

```

IRET_VIRTUAL:

```

IF ((RFLAGS.IOPL<3) && (CR4.VME=0))
    EXCEPTION [#GP(0)]

POP.v temp_RIP
POP.v temp_CS
POP.v temp_RFLAGS

IF (temp_RIP > CS.limit)
    EXCEPTION [#GP(0)]

IF (RFLAGS.IOPL=3)
{
    RFLAGS.v = temp_RFLAGS // VIF,VIP,VM,IOPL unchanged
                          // RF cleared

    CS.sel = temp_CS
    CS.base = temp_CS SHL 4

    RIP = temp_RIP
    EXIT
}

```

```

// now ((IOPL<3) && (CR4.VME=1)

ELSIF ((OPERAND_SIZE=16)
      && !((temp_RFLAGS.IF=1) && (RFLAGS.VIP=1))
      && (temp_RFLAGS.TF=0))
{
    RFLAGS.w = temp_RFLAGS // RFLAGS.VIF=temp_RFLAGS.IF
                          // IF,IOPL unchanged
                          // RF cleared

    CS.sel = temp_CS
    CS.base = temp_CS SHL 4

    RIP = temp_RIP
    EXIT
}
ELSE // ((RFLAGS.IOPL<3) && (CR4.VME=1) && ((OPERAND_SIZE=32) ||
      // ((temp_RFLAGS.IF=1) && (RFLAGS.VIP=1)) || (temp_RFLAGS.TF=1)))
      EXCEPTION [#GP(0)]

```

IRET_FROM_PROTECTED_TO_VIRTUAL:

```

// temp_RIP already popped
// temp_CS already popped
// temp_RFLAGS already popped, temp_RFLAGS.VM=1

POP.d temp_RSP
POP.d temp_SS
POP.d temp_ES
POP.d temp_DS
POP.d temp_FS
POP.d temp_GS

CS.sel = temp_CS // force the segments to have virtual-mode values
CS.base = temp_CS SHL 4
CS.limit= 0x0000FFFF
CS.attr = 16-bit dp13 code

SS.sel = temp_SS
SS.base = temp_SS SHL 4
SS.limit= 0x0000FFFF
SS.attr = 16-bit dp13 stack

DS.sel = temp_DS
DS.base = temp_DS SHL 4
DS.limit= 0x0000FFFF
DS.attr = 16-bit dp13 data

ES.sel = temp_ES
ES.base = temp_ES SHL 4
ES.limit= 0x0000FFFF

```

ES.attr = 16-bit dpl3 data

FS.sel = temp_FS
 FS.base = temp_FS SHL 4
 FS.limit= 0x0000FFFF
 FS.attr = 16-bit dpl3 data

GS.sel = temp_GS
 GS.base = temp_GS SHL 4
 GS.limit= 0x0000FFFF
 GS.attr = 16-bit dpl3 data

RSP.d = temp_RSP
 RFLAGS.d = temp_RFLAGS
 CPL = 3

RIP = temp_RIP AND 0x0000FFFF
 EXIT

Related Instructions

INT, INTO, INT3

rFLAGS Affected

ID	VIP	VIF	AC	VM	RF	NT	IOPL	OF	DF	IF	TF	SF	ZF	AF	PF	CF
M	M	M	M	M	M	M	M	M	M	M	M	M	M	M	M	M
21	20	19	18	17	16	14	13–12	11	10	9	8	7	6	4	2	0

Note: Bits 31–22, 15, 5, 3, and 1 are reserved. A flag set to one or cleared to zero is M (modified). Unaffected flags are blank. Undefined flags are U.

Exceptions

Exception	Real	Virtual 8086	Protected	Cause of Exception
Segment not present, #NP (selector)			X	The return code segment was marked not present.
Stack, #SS	X	X	X	A memory address exceeded the stack segment limit or was non-canonical.
Stack, #SS (selector)			X	The SS register was loaded with a non-null segment selector and the segment was marked not present.

Exception	Real	Virtual 8086	Protected	Cause of Exception
General protection, #GP	X	X	X	<p>The target offset exceeded the code segment limit or was non-canonical.</p> <p>IOPL was less than 3 and one of the following conditions was true:</p> <ul style="list-style-type: none"> • CR4.VME was 0. • The effective operand size was 32-bit. • Both the original EFLAGS.VIP and the new EFLAGS.IF were set. • The new EFLAGS.TF was set.
General protection, #GP (selector)			X	<p>The return code selector was a null selector.</p> <p>X The return stack selector was a null selector and the return mode was non-64-bit mode or CPL was 3.</p> <p>X The return code or stack descriptor exceeded the descriptor table limit.</p> <p>X The return code or stack selector's TI bit was set but the LDT selector was a null selector.</p> <p>X The segment descriptor for the return code was not a code segment.</p> <p>X The RPL of the return code segment selector was less than the CPL.</p> <p>X The return code segment was non-conforming and the segment selector's DPL was not equal to the RPL of the code segment's segment selector.</p> <p>X The return code segment was conforming and the segment selector's DPL was greater than the RPL of the code segment's segment selector.</p> <p>X The segment descriptor for the return stack was not a writable data segment.</p> <p>X The stack segment descriptor DPL was not equal to the RPL of the return code segment selector.</p> <p>X The stack segment selector RPL was not equal to the RPL of the return code segment selector.</p>
Page fault, #PF		X	X	A page fault resulted from the execution of the instruction.
Alignment check, #AC		X	X	An unaligned memory reference was performed while alignment checking was enabled.

LAR Load Access Rights Byte

Loads the access rights from the segment descriptor specified by a 16-bit source register or memory operand into a specified 16-bit, 32-bit, or 64-bit general-purpose register and sets the zero (ZF) flag in the rFLAGS register if successful. LAR clears the zero flag if the descriptor is invalid for any reason.

The LAR instruction checks that:

- the segment selector is not a null selector.
- the descriptor is within the GDT or LDT limit.
- the descriptor DPL is greater than or equal to both the CPL and RPL, or the segment is a conforming code segment.
- the descriptor type is valid for the LAR instruction. Valid descriptor types are shown in the following table. LDT and TSS descriptors in 64-bit mode, and call-gate descriptors in long mode, are only valid if bits 12–8 of doubleword +12 are zero, as shown on page 111 of vol. 2 in Figure 4-22.

Valid Descriptor Type		Description
Legacy Mode	Long Mode	
–	–	All code and data descriptors
1	–	Available 16-bit TSS
2	2	LDT
3	–	Busy 16-bit TSS
4	–	16-bit call gate
5	–	Task gate
9	9	Available 32-bit or 64-bit TSS
B	B	Busy 32-bit or 64-bit TSS
C	C	32-bit or 64-bit call gate

If the segment descriptor passes these checks, the attributes are loaded into the destination general-purpose register. If it does not, then the zero flag is cleared and the destination register is not modified.

When the operand size is 16 bits, access rights include the DPL and Type fields located in bytes 4 and 5 of the descriptor table entry. Before loading the access rights into the destination operand, the low order word is masked with FF00H.

When the operand size is 32 or 64 bits, access rights include the DPL and type as well as the descriptor type (S field), segment present (P flag), available to system (AVL flag), default operation size (D/B flag), and granularity flags located in bytes 4–7 of the descriptor. Before being loaded into the destination operand, the doubleword is masked with 00FF_FF00H.

In 64-bit mode, for both 32-bit and 64-bit operand sizes, 32-bit register results are zero-extended to 64 bits.

This instruction can only be executed in protected mode.

Mnemonic	Opcode	Description
LAR <i>reg16, reg/mem16</i>	0F 02 /r	Reads the GDT/LDT descriptor referenced by the 16-bit source operand, masks the attributes with FF00h and saves the result in the 16-bit destination register.
LAR <i>reg32, reg/mem16</i>	0F 02 /r	Reads the GDT/LDT descriptor referenced by the 16-bit source operand, masks the attributes with 00FFFF00h and saves the result in the 32-bit destination register.
LAR <i>reg64, reg/mem16</i>	0F 02 /r	Reads the GDT/LDT descriptor referenced by the 16-bit source operand, masks the attributes with 00FFFF00h and saves the result in the 64-bit destination register.

Related Instructions

ARPL, LSL, VERR, VERW

rFLAGS Affected

ID	VIP	VIF	AC	VM	RF	NT	IOPL	OF	DF	IF	TF	SF	ZF	AF	PF	CF
													M			
21	20	19	18	17	16	14	13–12	11	10	9	8	7	6	4	2	0
<i>Note: Bits 31–22, 15, 5, 3, and 1 are reserved. A flag set to one or zero is M (modified). Unaffected flags are blank. Undefined flags are U.</i>																

Exceptions

Exception	Real	Virtual 8086	Protected	Cause of Exception
Invalid opcode, #UD	X	X		This instruction is only recognized in protected mode.
Stack, #SS			X	A memory address exceeded the stack segment limit or was non-canonical.
General protection, #GP			X	A memory address exceeded the data segment limit or was non-canonical.
			X	A null data segment was used to reference memory.
			X	The extended attribute bits of a system descriptor was not zero in 64-bit mode.
Page fault, #PF			X	A page fault resulted from the execution of the instruction.
Alignment check, #AC			X	An unaligned memory reference was performed while alignment checking was enabled.

LGDT Load Global Descriptor Table Register

Loads the pseudo-descriptor specified by the source operand into the global descriptor table register (GDTR). The pseudo-descriptor is a memory location containing the GDTR base and limit. In legacy and compatibility mode, the pseudo-descriptor is 6 bytes; in 64-bit mode, it is 10 bytes.

If the operand size is 16 bits, the high-order byte of the 6-byte pseudo-descriptor is not used. The lower two bytes specify the 16-bit limit and the third, fourth, and fifth bytes specify the 24-bit base address. The high-order byte of the GDTR is filled with zeros.

If the operand size is 32 bits, the lower two bytes specify the 16-bit limit and the upper four bytes specify a 32-bit base address.

In 64-bit mode, the lower two bytes specify the 16-bit limit and the upper eight bytes specify a 64-bit base address. In 64-bit mode, operand-size prefixes are ignored and the operand size is forced to 64-bits; therefore, the pseudo-descriptor is always 10 bytes.

This instruction is only used in operating system software and must be executed at CPL 0. It is typically executed once in real mode to initialize the processor before switching to protected mode.

LGDT is a serializing instruction.

Mnemonic	Opcode	Description
LGDT <i>mem16:32</i>	0F 01 /2	Loads <i>mem16:32</i> into the global descriptor table register.
LGDT <i>mem16:64</i>	0F 01 /2	Loads <i>mem16:64</i> into the global descriptor table register.

Related Instructions

LIDT, LLDT, LTR, SGDT, SIDT, SLDT, STR

rFLAGS Affected

None

Exceptions

Exception	Real	Virtual 8086	Protected	Cause of Exception
Invalid opcode, #UD	X	X	X	The operand was a register.
Stack, #SS	X		X	A memory address exceeded the stack segment limit or was non-canonical.
General protection, #GP	X	X	X	A memory address exceeded the data segment limit or was non-canonical.
			X	CPL was not 0.
			X	The new GDT base address was non-canonical.
			X	A null data segment was used to reference memory.
Page fault, #PF			X	A page fault resulted from the execution of the instruction.

LIDT Load Interrupt Descriptor Table Register

Loads the pseudo-descriptor specified by the source operand into the interrupt descriptor table register (IDTR). The pseudo-descriptor is a memory location containing the IDTR base and limit. In legacy and compatibility mode, the pseudo-descriptor is six bytes; in 64-bit mode, it is 10 bytes.

If the operand size is 16 bits, the high-order byte of the 6-byte pseudo-descriptor is not used. The lower two bytes specify the 16-bit limit and the third, fourth, and fifth bytes specify the 24-bit base address. The high-order byte of the IDTR is filled with zeros.

If the operand size is 32 bits, the lower two bytes specify the 16-bit limit and the upper four bytes specify a 32-bit base address.

In 64-bit mode, the lower two bytes specify the 16-bit limit, and the upper eight bytes specify a 64-bit base address. In 64-bit mode, operand-size prefixes are ignored and the operand size is forced to 64-bits; therefore, the pseudo-descriptor is always 10 bytes.

This instruction is only used in operating system software and must be executed at CPL 0. It is normally executed once in real mode to initialize the processor before switching to protected mode.

LIDT is a serializing instruction.

Mnemonic	Opcode	Description
LIDT <i>mem16:32</i>	0F 01 /3	Loads <i>mem16:32</i> into the interrupt descriptor table register.
LIDT <i>mem16:64</i>	0F 01 /3	Loads <i>mem16:64</i> into the interrupt descriptor table register.

Related Instructions

LGDT, LLDT, LTR, SGDT, SIDT, SLDT, STR

rFLAGS Affected

None

Exceptions

Exception	Real	Virtual 8086	Protected	Cause of Exception
Invalid opcode, #UD	X	X	X	The operand was a register.
Stack, #SS	X		X	A memory address exceeded the stack segment limit or was non-canonical.
General protection, #GP	X	X	X	A memory address exceeded the data segment limit or was non-canonical.
			X	CPL was not 0.
			X	The new IDT base address was non-canonical.
			X	A null data segment was used to reference memory.
Page fault, #PF			X	A page fault resulted from the execution of the instruction.

LLDT Load Local Descriptor Table Register

Loads the specified segment selector into the visible portion of the local descriptor table (LDT). The processor uses the selector to locate the descriptor for the LDT in the global descriptor table. It then loads this descriptor into the hidden portion of the LDTR.

If the source operand is a null selector, the LDTR is marked invalid and all references to descriptors in the LDT will generate a general protection exception (#GP), except for the LAR, VERR, VERW or LSL instructions.

In legacy and compatibility modes, the LDT descriptor is 8 bytes long and contains a 32-bit base address.

In 64-bit mode, the LDT descriptor is 16-bytes long and contains a 64-bit base address. The LDT descriptor type (02h) is redefined in 64-bit mode for use as the 16-byte LDT descriptor.

This instruction must be executed in protected mode. It is only provided for use by operating system software at CPL 0.

LLDT is a serializing instruction.

Mnemonic	Opcode	Description
LLDT <i>reg/mem16</i>	0F 00 /2	Load the 16-bit segment selector into the local descriptor table register and load the LDT descriptor from the GDT.

Related Instructions

LGDT, LIDT, LTR, SGDT, SIDT, SLDT, STR

rFLAGS Affected

None

Exceptions

Exception	Real	Virtual 8086	Protected	Cause of Exception
Invalid opcode, #UD	X	X		This instruction is only recognized in protected mode.
Segment not present, #NP (selector)			X	The LDT descriptor was marked not present.
Stack, #SS			X	A memory address exceeded the stack segment limit or was non-canonical.
General protection, #GP			X	A memory address exceeded a data segment limit or was non-canonical.
			X	CPL was not 0.
			X	A null data segment was used to reference memory.
General protection, #GP (selector)			X	The source selector did not point into the GDT.
			X	The descriptor was beyond the GDT limit.
			X	The descriptor was not an LDT descriptor.
			X	The descriptor's extended attribute bits were not zero in 64-bit mode.
			X	The new LDT base address was non-canonical.
Page fault, #PF			X	A page fault resulted from the execution of the instruction.

LMSW Load Machine Status Word

Loads the lower four bits of the 16-bit register or memory operand into bits 3–0 of the machine status word in register CR0. Only the protection enabled (PE), monitor coprocessor (MP), emulation (EM), and task switched (TS) bits of CR0 are modified. Additionally, LMSW can set CR0.PE, but cannot clear it.

The LMSW instruction can be used only when the current privilege level is 0. It is only provided for compatibility with early processors.

Use the MOV CR0 instruction to load all 32 or 64 bits of CR0.

Mnemonic	Opcode	Description
LMSW <i>reg/mem16</i>	0F 01 /6	Load the lower 4 bits of the source into the lower 4 bits of CR0.

Related Instructions

MOV (CR_n), SMSW

rFLAGS Affected

None

Exceptions

Exception	Real	Virtual 8086	Protected	Cause of Exception
Stack, #SS	X		X	A memory address exceeded the stack segment limit or was non-canonical.
General protection, #GP	X	X	X	CPL was not 0.
			X	A null data segment was used to reference memory.
Page fault, #PF			X	A page fault resulted from the execution of the instruction.

LSL Load Segment Limit

Loads the segment limit from the segment descriptor specified by a 16-bit source register or memory operand into a specified 16-bit, 32-bit, or 64-bit general-purpose register and sets the zero (ZF) flag in the rFLAGS register if successful. LSL clears the zero flag if the descriptor is invalid for any reason.

In 64-bit mode, for both 32-bit and 64-bit operand sizes, 32-bit register results are zero-extended to 64 bits.

The LSL instruction checks that:

- the segment selector is not a null selector.
- the descriptor is within the GDT or LDT limit.
- the descriptor DPL is greater than or equal to both the CPL and RPL, or the segment is a conforming code segment.
- the descriptor type is valid for the LAR instruction. Valid descriptor types are shown in the following table. LDT and TSS descriptors in 64-bit mode are only valid if bits 12–8 of doubleword +12 are zero, as shown on page 111 of vol. 2 in Figure 4-22.

Valid Descriptor Type		Description
Legacy Mode	Long Mode	
–	–	All code and data descriptors
1	–	Available 16-bit TSS
2	2	LDT
3	–	Busy 16-bit TSS
9	9	Available 32-bit or 64-bit TSS
B	B	Busy 32-bit or 64-bit TSS

If the segment selector passes these checks and the segment limit is loaded into the destination general-purpose register, the instruction sets the zero flag of the rFLAGS register to 1. If the selector does not pass the checks, then LSL clears the zero flag to 0 and does not modify the destination.

The instruction calculates the segment limit to 32 bits, taking the 20-bit limit and the granularity bit into account. When the operand size is 16 bits, it truncates the upper

16 bits of the 32-bit adjusted segment limit and loads the lower 16-bits into the target register.

Mnemonic	Opcode	Description
LSL <i>reg16, reg/mem16</i>	0F 03 /r	Loads a 16-bit general-purpose register with the segment limit for a selector specified in a 16-bit memory or register operand.
LSL <i>reg32, reg/mem16</i>	0F 03 /r	Loads a 32-bit general-purpose register with the segment limit for a selector specified in a 16-bit memory or register operand.
LSL <i>reg64, reg/mem16</i>	0F 03 /r	Loads a 64-bit general-purpose register with the segment limit for a selector specified in a 16-bit memory or register operand.

Related Instructions

ARPL, LAR, VERR, VERW

rFLAGS Affected

ID	VIP	VIF	AC	VM	RF	NT	IOPL	OF	DF	IF	TF	SF	ZF	AF	PF	CF
													M			
21	20	19	18	17	16	14	13–12	11	10	9	8	7	6	4	2	0

Note: Bits 31–22, 15, 5, 3, and 1 are reserved. A flag set to 1 or cleared to 0 is M (modified). Unaffected flags are blank. Undefined flags are U.

Exceptions

Exception	Real	Virtual 8086	Protected	Cause of Exception
Invalid opcode, #UD	X	X		This instruction is only recognized in protected mode.
Stack, #SS			X	A memory address exceeded the stack segment limit or was non-canonical.
General protection, #GP			X	A memory address exceeded a data segment limit or was non-canonical.
			X	A null data segment was used to reference memory.
			X	The extended attribute bits of a system descriptor was not zero in 64-bit mode
Page fault, #PF			X	A page fault resulted from the execution of the instruction.
Alignment check, #AC			X	An unaligned memory reference was performed while alignment checking was enabled.

LTR Load Task Register

Loads the specified segment selector into the visible portion of the task register (TR). The processor uses the selector to locate the descriptor for the TSS in the global descriptor table. It then loads this descriptor into the hidden portion of TR. The TSS descriptor in the GDT is marked busy, but no task switch is made.

If the source operand is null, a general protection exception (#GP) is generated.

In legacy and compatibility modes, the TSS descriptor is 8 bytes long and contains a 32-bit base address.

In 64-bit mode, the instruction references a 64-bit descriptor to load a 64-bit base address. The TSS type (09H) is redefined in 64-bit mode for use as the 16-byte TSS descriptor.

This instruction must be executed in protected mode when the current privilege level is 0. It is only provided for use by operating system software.

The operand size attribute has no effect on this instruction.

LTR is a serializing instruction.

Mnemonic	Opcode	Description
LTR <i>reg/mem16</i>	OF 00 /3	Load the 16-bit segment selector into the task register and load the TSS descriptor from the GDT.

Related Instructions

LGDT, LIDT, LLDT, STR, SGDT, SIDT, SLDT

rFLAGS Affected

None

Exceptions

Exception	Real	Virtual 8086	Protected	Cause of Exception
Invalid opcode, #UD	X	X		This instruction is only recognized in protected mode.
Segment not present, #NP (selector)			X	The TSS descriptor was marked not present.
Stack, #SS			X	A memory address exceeded the stack segment limit or was non-canonical.
General protection, #GP			X	A memory address exceeded a data segment limit or was non-canonical.
			X	CPL was not 0.
			X	A null data segment was used to reference memory.
			X	The new TSS selector was a null selector.
General protection, #GP (selector)			X	The source selector did not point into the GDT.
			X	The descriptor was beyond the GDT limit.
			X	The descriptor was not an available TSS descriptor.
			X	The descriptor's extended attribute bits were not zero in 64-bit mode.
			X	The new TSS base address was non-canonical.
Page fault, #PF			X	A page fault resulted from the execution of the instruction.

MOV(CR n) Move to/from Control Registers

Moves the contents of a 32-bit or 64-bit general-purpose register to a control register or vice versa.

In 64-bit mode, the operand size is fixed at 64 bits without the need for a REX prefix. In non-64-bit mode, the operand size is fixed at 32 bits and the upper 32 bits of the destination are forced to 0.

CR0 maintains the state of various control bits. CR2 and CR3 are used for page translation. CR4 holds various feature enable bits. CR8 is used to prioritize external interrupts. CR1, CR5, CR6, CR7, and CR9 through CR15 are all reserved and raise an undefined opcode exception (#UD) if referenced.

Reading or writing to CR8 requires a REX prefix, and thus can only be accessed in 64-bit mode. However, it can also be read and modified using the task priority register described in “System-Control Registers” in Volume 2.

This instruction is always treated as a register-to-register (MOD = 11) instruction, regardless of the encoding of the MOD field in the MODR/M byte.

MOV(CR n) is a privileged instruction and must always be executed at CPL = 0.

MOV (CR n) is a serializing instruction.

Mnemonic	Opcode	Description
MOV CR n , reg32	0F 22 /r	Move the contents of a 32-bit register to CR n
MOV CR n , reg64	0F 22 /r	Move the contents of a 64-bit register to CR n
MOV reg32, CR n	0F 20 /r	Move the contents of CR n to a 32-bit register.
MOV reg64, CR n	0F 20 /r	Move the contents of CR n to a 64-bit register.

Note:

CR0, CR2, CR3, CR4, and CR8 are the only registers to which this instruction applies. See text for details.

Related Instructions

CLTS, LMSW, SMSW

rFLAGS Affected

None

Exceptions

Exception	Real	Virtual 8086	Protected	Cause of Exception
Invalid Instruction, #UD	X	X	X	An illegal control register was referenced (CR1, CR5–CR7, CR9–CR15).
General protection, #GP		X	X	CPL was not 0.
	X		X	An attempt was made to set CR0.PG = 1 and CR0.PE = 0.
	X		X	An attempt was made to set CR0.CD = 0 and CR0.NW = 1.
	X		X	Reserved bits were set in the page-directory pointers table (used in the legacy extended physical addressing mode) and the instruction modified CR0, CR3, or CR4.
	X		X	An attempt was made to write 1 to any reserved bit in CR0, CR3, CR4 or CR8.
	X		X	An attempt was made to set CR0.PG while long mode was enabled (EFER.LME = 1), but paging address extensions were disabled (CR4.PAE = 0).
			X	An attempt was made to clear CR4.PAE while long mode was active (EFER.LMA = 1).

MOV(DR n) Move to/from Debug Registers

Moves the contents of a debug register into a 32-bit or 64-bit general-purpose register or vice versa.

In 64-bit mode, the operand size is fixed at 64 bits without the need for a REX prefix. In non-64-bit mode, the operand size is fixed at 32-bits and the upper 32 bits of the destination are forced to 0.

DR0 through DR3 are linear breakpoint address registers. DR6 is the debug status register and DR7 is the debug control register. DR4 and DR5 are aliased to DR6 and DR7 if CR4.DE = 0, and are reserved if CR4.DE = 1.

DR8 through DR15 are reserved and generate an undefined opcode exception if referenced.

These instructions are privileged and must be executed at CPL 0.

The *MOV DR n , reg32* and *MOV DR n , reg64* instructions are serializing instructions.

The MOV(DR) instruction is always treated as a register-to-register (MOD = 11) instruction, regardless of the encoding of the MOD field in the MODR/M byte.

See “Debug and Performance Resources” in Volume 2 for details.

Mnemonic	Opcode	Description
MOV <i>reg32</i> , DR n	0F 21 /r	Move the contents of DR n to a 32-bit register.
MOV <i>reg64</i> , DR n	0F 21 /r	Move the contents of DR n to a 64-bit register.
MOV DR n , <i>reg32</i>	0F 23 /r	Move the contents of a 32-bit register to DR n .
MOV DR n , <i>reg64</i>	0F 23 /r	Move the contents of a 64-bit register to DR n .

Related Instructions

None

rFLAGS Affected

None

Exceptions

Exception	Real	Virtual 8086	Protected	Cause of Exception
Debug, #DB	X		X	A debug register was referenced while the general detect (GD) bit in DR7 was set.
Invalid opcode, #UD	X		X	DR4 or DR5 was referenced while the debug extensions (DE) bit in CR4 was set.
			X	An illegal debug register (DR8-DR15) was referenced.
General protection, #GP		X	X	CPL was not 0.
			X	A 1 was written to any of the upper 32 bits of DR6 or DR7 in 64-bit mode.

RDMSR Read Model-Specific Register

Loads the contents of a 64-bit model-specific register (MSR) specified in the ECX register into registers EDX:EAX. The EDX register receives the high-order 32 bits and the EAX register receives the low order bits. The RDMSR instruction ignores operand size; ECX always holds the MSR number, and EDX:EAX holds the data. If a model-specific register has fewer than 64 bits, the unimplemented bit positions loaded into the destination registers are undefined.

This instruction must be executed at a privilege level of 0 or a general protection exception (#GP) will be raised. This exception is also generated if a reserved or unimplemented model-specific register is specified in ECX.

Use the CPUID instruction to determine if this instruction is supported.

RDMSR is a serializing instruction.

For more information about model-specific registers, see the documentation for various hardware implementations and Volume 2, *System Programming*.

Mnemonic	Opcode	Description
RDMSR	0F 32	Copy MSR specified by ECX into EDX:EAX.

Related Instructions

WRMSR, RDTSC, RDPMSR

rFLAGS Affected

None

Exceptions

Exception	Real	Virtual 8086	Protected	Cause of Exception
Invalid opcode, #UD	X	X	X	The RDMSR instruction is not supported, as indicated by bit 5 of CPUID function 1 or 8000_0001h.
General protection, #GP	X	X	X	CPL was not 0. The value in ECX specifies a reserved or unimplemented MSR address.

RDPMC**Read Performance-Monitoring Counter**

Loads the contents of a 64-bit performance counter register (PerfCtrn) specified in the ECX register into registers EDX:EAX. The EDX register receives the high-order 32 bits and the EAX register receives the low order 32 bits. The RDPMC instruction ignores operand size; ECX always holds the PerfCtr number, and EDX:EAX holds the data.

The AMD64 architecture currently supports four performance counters: PerfCtr0 through PerfCtr3.

Programs running at any privilege level can read performance monitor counters if the PCE flag in CR4 is set to 1; otherwise this instruction must be executed at a privilege level of 0.

This instruction is not serializing. Therefore, there is no guarantee that all instructions have completed at the time the performance counter is read.

For more information about performance-counter registers, see the documentation for various hardware implementations and “Performance Counters” in Volume 2.

Mnemonic	Opcode	Description
RDPMC	0F 33	Copy the performance monitor counter specified by ECX into EDX:EAX.

Related Instructions

RDMSR, WRMSR

rFLAGS Affected

None

Exceptions

Exception	Real	Virtual 8086	Protected	Cause of Exception
General Protection, #GP	X	X	X	The value in ECX specified an unimplemented performance counter number.
		X	X	CPL was not 0 and CR4.PCE = 0.

RDTSC**Read Time-Stamp Counter**

Loads the value of the processor's 64-bit time-stamp counter into registers EDX:EAX.

The time-stamp counter is contained in a 64-bit model-specific register (MSR). The processor sets the counter to 0 upon reset and increments the counter every clock cycle. INIT does not modify the TSC.

The high-order 32 bits are loaded into EDX, and the low-order 32 bits are loaded into the EAX register. This instruction ignores operand size.

When the time-stamp disable flag (TSD) in CR4 is set to 1, the RDTSC instruction can only be used at privilege level 0. If the TSD flag is 0, this instruction can be used at any privilege level.

This instruction is not serializing. Therefore, there is no guarantee that all instructions have completed at the time the time-stamp counter is read.

Mnemonic	Opcode	Description
RDTSC	0F 31	Copy the time-stamp counter into EDX:EAX.

Related Instructions

RDMSR, WRMSR

rFLAGS Affected

None

Exceptions

Exception	Real	Virtual 8086	Protected	Cause of Exception
Invalid opcode, #UD	X	X	X	The RDTSC instruction is not supported, as indicated by bit 4 of CPUID function 1 or 8000_0001h.
General protection, #GP		X	X	CPL was not 0 and CR4.TSD = 1.

RSM**Resume from System Management Mode**

Resumes an operating system or application procedure previously interrupted by a system management interrupt (SMI). The processor state is restored from the information saved when the SMI was taken. If the processor detects invalid state information in the system management mode (SMM) save area during RSM, it goes into a shutdown state.

RSM will shutdown if any of the following conditions are found in the save map (SSM):

- An illegal combination of flags in CR0 (CR0.PG = 1 and CR0.PE = 0, or CR0.NW = 1 and CR0.CD = 0).
- A reserved bit in CR0, CR3, CR4, DR6, DR7, or the extended feature enable register (EFER) is set to 1.
- The following bit combination occurs: EFER.LME = 1, CR0.PG = 1, CR4.PAE = 0.
- The following bit combination occurs: CR0.PE = 1, CR0.PG = 1, EFER.LME = 1, CR4.PAE = 1, CS.D = 1, CS.L = 1.
- SMM revision field has been modified.

The AMD64 architecture uses a new 64-bit SMM state-save memory image. This 64-bit save-state map is used in all modes, regardless of mode. See “System-Management Mode” in Volume 2 for details.

Mnemonic	Opcode	Description
RSM	0F AA	Resume operation of an interrupted program.

Related Instructions

None

rFLAGS Affected

All flags are restored from the state-save map (SSM).

ID	VIP	VIF	AC	VM	RF	NT	IOPL	OF	DF	IF	TF	SF	ZF	AF	PF	CF
M	M	M	M	M	M	M	M	M	M	M	M	M	M	M	M	M
21	20	19	18	17	16	14	13–12	11	10	9	8	7	6	4	2	0

Note: Bits 31–22, 15, 5, 3, and 1 are reserved. A flag set to 1 or cleared to 0 is M (modified). Unaffected flags are blank. Undefined flags are U.

Exceptions

Exception	Real	Virtual 8086	Protected	Cause of Exception
Invalid opcode, #UD	X	X	X	The processor was not in System Management Mode (SMM).

SGDT Store Global Descriptor Table Register

Stores the global descriptor table register (GDTR) into the destination operand. In legacy and compatibility mode, the destination operand is six bytes; in 64-bit mode, it is 10 bytes. In all modes, operand-size prefixes are ignored.

In non-64-bit mode, the lower two bytes of the operand specify the 16-bit limit and the upper 4 bytes specify the 32-bit base address.

In 64-bit mode, the lower two bytes of the operand specify the 16-bit limit and the upper 8 bytes specify the 64-bit base address.

This instruction is intended for use in operating system software, but it can be used at any privilege level.

Mnemonic	Opcode	Description
SGDT <i>mem16:32</i>	0F 01 /0	Store global descriptor table register to memory.
SGDT <i>mem16:64</i>	0F 01 /0	Store global descriptor table register to memory.

Related Instructions

SIDT, SLDT, STR, LGDT, LIDT, LLDT, LTR

rFLAGS Affected

None

Exceptions

Exception	Real	Virtual 8086	Protected	Cause of Exception
Invalid opcode, #UD	X	X	X	The operand was a register.
Stack, #SS	X	X	X	A memory address exceeded the stack segment limit or was non-canonical.

Exception	Real	Virtual 8086	Protected	Cause of Exception
General protection, #GP	X	X	X	A memory address exceeded a data segment limit or was non-canonical.
			X	The destination operand was in a non-writable segment.
			X	A null data segment was used to reference memory.
Page fault, #PF		X	X	A page fault resulted from the execution of the instruction.
Alignment check, #AC		X	X	An unaligned memory reference was performed while alignment checking was enabled.

SIDT Store Interrupt Descriptor Table Register

Stores the interrupt descriptor table register (IDTR) in the destination operand. In legacy and compatibility mode, the destination operand is 6 bytes; in 64-bit mode it is 10 bytes. In all modes, operand-size prefixes are ignored.

In non-64-bit mode, the lower two bytes of the operand specify the 16-bit limit and the upper 4 bytes specify the 32-bit base address.

In 64-bit mode, the lower two bytes of the operand specify the 16-bit limit and the upper 8 bytes specify the 64-bit base address.

This instruction is intended for use in operating system software, but it can be used at any privilege level.

Mnemonic	Opcode	Description
SIDT <i>mem16:32</i>	0F 01 /1	Store interrupt descriptor table register to memory.
SIDT <i>mem16:64</i>	0F 01 /1	Store interrupt descriptor table register to memory.

Related Instructions

SGDT, SLDT, STR, LGDT, LIDT, LLDT, LTR

rFLAGS Affected

None

Exceptions

Exception	Real	Virtual 8086	Protected	Cause of Exception
Invalid opcode, #UD	X	X	X	The operand was a register.
Stack, #SS	X	X	X	A memory address exceeded the stack segment limit or was non-canonical.

Exception	Real	Virtual 8086	Protected	Cause of Exception
General protection, #GP	X	X	X	A memory address exceeded a data segment limit or was non-canonical.
			X	The destination operand was in a non-writable segment.
			X	A null data segment was used to reference memory.
Page fault, #PF		X	X	A page fault resulted from the execution of the instruction.
Alignment check, #AC		X	X	An unaligned memory reference was performed while alignment checking was enabled.

SLDT Store Local Descriptor Table Register

Stores the local descriptor table (LDT) selector to a register or memory destination operand.

If the destination is a register, the selector is zero-extended into a 16-, 32-, or 64-bit general purpose register, depending on operand size.

If the destination operand is a memory location, the segment selector is written to memory as a 16-bit value, regardless of operand size.

This SLDT instruction can only be used in protected mode, but it can be executed at any privilege level.

Mnemonic	Opcode	Description
SLDT <i>reg16</i>	0F 00 /0	Store the segment selector from the local descriptor table register to a 16-bit register.
SLDT <i>reg32</i>	0F 00 /0	Store the segment selector from the local descriptor table register to a 32-bit register.
SLDT <i>reg64</i>	0F 00 /0	Store the segment selector from the local descriptor table register to a 64-bit register.
SLDT <i>mem16</i>	0F 00 /0	Store the segment selector from the local descriptor table register to a 16-bit memory location.

Related Instructions

SIDT, SGDT, STR, LIDT, LGDT, LLDT, LTR

rFLAGS Affected

None

Exceptions

Exception	Real	Virtual 8086	Protected	Cause of Exception
Invalid opcode, #UD	X	X		This instruction is only recognized in protected mode.
Stack, #SS			X	A memory address exceeded the stack segment limit or was non-canonical.
General protection, #GP			X	A memory address exceeded a data segment limit or was non-canonical.
			X	The destination operand was in a non-writable segment.
			X	A null data segment was used to reference memory.
Page fault, #PF			X	A page fault resulted from the execution of the instruction.
Alignment check, #AC			X	An unaligned memory reference was performed while alignment checking was enabled.

SMSW**Store Machine Status Word**

Stores the lower bits of the machine status word (CR0). The target can be a 16-, 32-, or 64-bit register or a 16-bit memory operand.

This instruction is provided for compatibility with early processors.

This instruction can be used at any privilege level (CPL).

Mnemonic	Opcode	Description
SMSW <i>reg16</i>	0F 01 /4	Store the low 16 bits of CR0 to a 16-bit register.
SMSW <i>reg32</i>	0F 01 /4	Store the low 32 bits of CR0 to a 32-bit register.
SMSW <i>reg64</i>	0F 01 /4	Store the entire 64-bit CR0 to a 64-bit register.
SMSW <i>mem16</i>	0F 01 /4	Store the low 16 bits of CR0 to memory.

Related Instructions

LMSW, MOV(CR n)

rFLAGS Affected

None

Exceptions

Exception	Real	Virtual 8086	Protected	Cause of Exception
Stack, #SS	X	X	X	A memory address exceeded the stack segment limit or was non-canonical.
General protection, #GP	X	X	X	The destination operand was in a non-writable segment.
			X	A null data segment was used to reference memory.
Page fault, #PF		X	X	A page fault resulted from the execution of the instruction.
Alignment check, #AC		X	X	An unaligned memory reference was performed while alignment checking was enabled.

STI Set Interrupt Flag

Sets the interrupt flag (IF) in the rFLAGS register to 1, thereby allowing external interrupts received on the INTR input. Interrupts received on the non-maskable interrupt (NMI) input are not affected by this instruction.

In real mode, this instruction sets IF to 1.

In protected mode and virtual-8086-mode, this instruction is IOPL-sensitive. If the CPL is less than or equal to the rFLAGS.IOPL field, the instruction sets IF to 1.

In protected mode, if $IOPL < 3$, $CPL = 3$, and protected mode virtual interrupts are enabled ($CR4.PVI = 1$), then the instruction instead sets rFLAGS.VIF to 1. If none of these conditions apply, the processor raises a general protection exception (#GP). For more information, see “Protected Mode Virtual Interrupts” in Volume 2.

In virtual-8086 mode, if $IOPL < 3$ and the virtual-8086-mode extensions are enabled ($CR4.VME = 1$), the STI instruction instead sets the virtual interrupt flag (rFLAGS.VIF) to 1.

If STI sets the IF flag and IF was initially clear, then interrupts are not enabled until after the instruction following STI. Thus, if IF is 0, this code will not allow an INTR to happen:

```
STI
CLI
```

In the following sequence, INTR will be allowed to happen only after the NOP.

```
STI
NOP
CLI
```

If STI sets the VIF flag and VIP is already set, a #GP fault will be generated.

See “Virtual-8086 Mode Extensions” in Volume 2 for more information about IOPL-sensitive instructions.

Mnemonic	Opcode	Description
STI	FB	Set interrupt flag (IF) to 1.

Action

```

IF (CPL <= IOPL)
    RFLAGS.IF = 1

ELSF (((VIRTUAL_MODE) && (CR4.VME = 1))
      || ((PROTECTED_MODE) && (CR4.PVI = 1) && (CPL = 3)))
    {
        IF (RFLAGS.VIP = 1)
            EXCEPTION[#GP(0)]
            RFLAGS.VIF = 1
    }
ELSE
    EXCEPTION[#GP(0)]
    
```

Related Instructions

CLI

rFLAGS Affected

ID	VIP	VIF	AC	VM	RF	NT	IOPL	OF	DF	IF	TF	SF	ZF	AF	PF	CF
		M								M						
21	20	19	18	17	16	14	13-12	11	10	9	8	7	6	4	2	0

Note: Bits 31-22, 15, 5, 3, and 1 are reserved. M (modified) is either set to one or cleared to zero. Unaffected flags are blank. Undefined flags are U.

Exceptions

Exception	Real	Virtual 8086	Protected	Cause of Exception
General protection, #GP		X		The CPL was greater than the IOPL and virtual-mode extensions were not enabled (CR4.VME = 0).
			X	The CPL was greater than the IOPL and either the CPL was not 3 or protected-mode virtual interrupts were not enabled (CR4.PVI = 0).
		X	X	This instruction would set RFLAGS.VIF to 1 and RFLAGS.VIP was already 1.

STR Store Task Register

Stores the task register (TR) selector to a register or memory destination operand.

If the destination is a register, the selector is zero-extended into a 16-, 32-, or 64-bit general purpose register, depending on the operand size.

If the destination is a memory location, the segment selector is written to memory as a 16-bit value, regardless of operand size.

The STR instruction can only be used in protected mode, but it can be used at any privilege level.

Mnemonic	Opcode	Description
STR <i>reg16</i>	0F 00 /1	Store the segment selector from the task register to a 16-bit general-purpose register.
STR <i>reg32</i>	0F 00 /1	Store the segment selector from the task register to a 32-bit general-purpose register.
STR <i>reg64</i>	0F 00 /1	Store the segment selector from the task register to a 64-bit general-purpose register.
STR <i>mem16</i>	0F 00 /1	Store the segment selector from the task register to a 16-bit memory location.

Related Instructions

LGDT, LIDT, LLDT, LTR, SIDT, SGDT, SLDT

rFLAGS Affected

None

Exceptions

Exception	Real	Virtual 8086	Protected	Cause of Exception
Invalid opcode, #UD	X	X		This instruction is only recognized in protected mode.
Stack, #SS			X	A memory address exceeded the stack segment limit or was non-canonical.
General protection, #GP			X	A memory address exceeded a data segment limit or was non-canonical.
			X	The destination operand was in a non-writable segment.
			X	A null data segment was used to reference memory.
Page fault, #PF			X	A page fault resulted from the execution of the instruction.
Alignment check, #AC			X	An unaligned memory reference was performed while alignment checking was enabled.

SWAPGS**Swap GS Register with KernelGSbase MSR**

Provides a fast method for system software to load a pointer to system data structures. SWAPGS can be used upon entering system-software routines as a result of a SYSCALL instruction, an interrupt or an exception. Prior to returning to application software, SWAPGS can be used to restore the application data pointer that was replaced by the system data-structure pointer.

This instruction can only be executed in 64-bit mode. Executing SWAPGS in any other mode generates an undefined opcode exception.

The SWAPGS instruction only exchanges the base-address value located in the KernelGSbase model-specific register (MSR address C000_0102h) with the base-address value located in the hidden-portion of the GS selector register (GS.base). This allows the system-kernel software to access kernel data structures by using the GS segment-override prefix during memory references.

The address stored in the KernelGSbase MSR must be in canonical form. The WRMSR instruction used to load the KernelGSbase MSR causes a general-protection exception if the address loaded is not in canonical form. The SWAPGS instruction itself does not perform a canonical check.

This instruction is only valid in 64-bit mode at CPL 0. A general protection exception (#GP) is generated if this instruction is executed at any other privilege level.

For additional information about this instruction, refer to “System-Management Instructions” in Volume 2.

Examples

At a kernel entry point, the OS uses SwapGS to obtain a pointer to kernel data structures and simultaneously save the user's GS base. Upon exit, it uses SwapGS to restore the user's GS base:

```

SystemCallEntryPoint:
SwapGS                ; get kernel pointer, save user GSbase
mov gs:[SavedUserRSP], rsp ; save user's stack pointer
mov rsp, gs:[KernelStackPtr] ; set up kernel stack
push rax              ; now save user GPRs on kernel stack
                    ; perform system service
                    .
                    .
SwapGS                ; restore user GS, save kernel pointer

```

Mnemonic	Opcode	Description
SWAPGS	0F 01 F8	Exchange GS base with KernelGSBase MSR. (Invalid in legacy and compatibility modes.)

Related Instructions

None

rFLAGS Affected

None

Exceptions

Exception	Real	Virtual 8086	Protected	Cause of Exception
Invalid opcode, #UD	X	X	X	This instruction was executed in legacy or compatibility mode.
General protection, #GP			X	CPL was not 0.

SYSCALL **Fast System Call**

Transfers control to a fixed entry point in an operating system. It is designed for use by system and application software implementing a flat-segment memory model.

The SYSCALL and SYSRET instructions are low-latency system call and return control-transfer instructions, which assume that the operating system implements a flat-segment memory model. By eliminating unneeded checks, and by loading predetermined values into the CS and SS segment registers (both visible and hidden portions), calls to and returns from the operating system are greatly simplified. These instructions can be used in protected mode and are particularly well-suited for use in 64-bit mode, which requires implementation of a paged, flat-segment memory model.

This instruction has been optimized by reducing the number of checks and memory references that are normally made so that a call or return takes considerably fewer clock cycles than the CALL FAR /RET FAR instruction method.

It is assumed that the base, limit, and attributes of the Code Segment will remain flat for all processes and for the operating system, and that only the current privilege level for the selector of the calling process should be changed from a current privilege level of 3 to a new privilege level of 0. It is also assumed (but not checked) that the RPL of the SYSCALL and SYSRET target selectors are set to 0 and 3, respectively.

SYSCALL sets the CPL to 0, regardless of the values of bits 33–32 of the STAR register. There are no permission checks based on the CPL, real mode, or virtual-8086 mode. SYSCALL and SYSRET must be enabled by setting EFER.SCE to 1.

It is the responsibility of the operating system to keep the descriptors in memory that correspond to the CS and SS selectors loaded by the SYSCALL and SYSRET instructions consistent with the segment base, limit, and attribute values forced by these instructions.

Legacy x86 Mode. In legacy x86 mode, when SYSCALL is executed, the EIP register is copied into the ECX register. Bits 31–0 of the SYSCALL/SYSRET target address register (STAR) are copied into the EIP register. (The STAR register is model-specific register C000_0081h.)

New selectors are loaded, without permission checking (see above), as follows:

- Bits 47–32 of the STAR register specify the selector that is copied into the CS register.
- Bits 47–32 of the STAR register + 8 specify the selector that is copied into the SS register.

- The CS_base and the SS_base are both forced to zero.
- The CS_limit and the SS_limit are both forced to 4 Gbyte.
- The CS segment attributes are set to execute/read 32-bit code with a CPL of zero.
- The SS segment attributes are set to read/write and expand-up with a 32-bit stack referenced by ESP.

Long Mode. When long mode is activated, the behavior of the SYSCALL instruction depends on whether the calling software is in 64-bit mode or compatibility mode. In 64-bit mode, SYSCALL saves the RIP of the instruction following the SYSCALL into RCX and loads the new RIP from LSTAR bits 63–0. (The LSTAR register is model-specific register C000_0082h.) In compatibility mode, SYSCALL saves the RIP of the instruction following the SYSCALL into RCX and loads the new RIP from CSTAR bits 63–0. (The CSTAR register is model-specific register C000_0083h.)

New selectors are loaded, without permission checking (see above), as follows:

- Bits 47–32 of the STAR register specify the selector that is copied into the CS register.
- Bits 47–32 of the STAR register + 8 specify the selector that is copied into the SS register.
- The CS_base and the SS_base are both forced to zero.
- The CS_limit and the SS_limit are both forced to 4 Gbyte.
- The CS segment attributes are set to execute/read 64-bit code with a CPL of zero.
- The SS segment attributes are set to read/write and expand-up with a 64-bit stack referenced by RSP.

The WRMSR instruction loads the target RIP into the LSTAR and CSTAR registers. If an RIP written by WRMSR is not in canonical form, a general-protection exception (#GP) occurs.

How SYSCALL and SYSRET handle rFLAGS, depends on the processor's operating mode.

In legacy mode, SYSCALL treats EFLAGS as follows:

- EFLAGS.IF is cleared to 0.
- EFLAGS.RF is cleared to 0.
- EFLAGS.VM is cleared to 0.

In long mode, SYSCALL treats RFLAGS as follows:

- The current value of RFLAGS is saved in R11.
- RFLAGS is masked using the value stored in SYSCALL_FLAG_MASK.

- RFLAGS.RF is cleared to 0.

For further details on the SYSCALL and SYSRET instructions and their associated MSR registers (STAR, LSTAR, CSTAR, and SYSCALL_FLAG_MASK), see “Fast System Call and Return” in Volume 2.

Mnemonic	Opcode	Description
SYSCALL	0F 05	Call operating system.

Action

// See “Pseudocode Definitions” on page 48.

SYSCALL_START:

```

IF (MSR_EFER.SCE = 0)           // Check if syscall/sysret are enabled.
    EXCEPTION [#UD]

IF (LONG_MODE)
    SYSCALL_LONG_MODE
ELSE // (LEGACY_MODE)
    SYSCALL_LEGACY_MODE

```

SYSCALL_LONG_MODE:

```

RCX.q = next_RIP
R11.q = RFLAGS    // with rf cleared

IF (64BIT_MODE)
    temp_RIP.q = MSR_LSTAR
ELSE // (COMPATIBILITY_MODE)
    temp_RIP.q = MSR_CSTAR

CS.sel = MSR_STAR.SYSCALL_CS AND 0xFFFFC
CS.attr = 64-bit code,dp10 // Always switch to 64-bit mode in long mode.
CS.base = 0x00000000
CS.limit = 0xFFFFFFFF

SS.sel = MSR_STAR.SYSCALL_CS + 8
SS.attr = 64-bit stack,dp10
SS.base = 0x00000000
SS.limit = 0xFFFFFFFF

RFLAGS = RFLAGS AND ~MSR_SFMASK
RFLAGS.RF = 0

CPL = 0

```

```
RIP = temp_RIP
EXIT
```

SYSCALL_LEGACY_MODE:

```
RCX.d = next_RIP

temp_RIP.d = MSR_STAR.EIP

CS.sel  = MSR_STAR.SYSCALL_CS AND 0xFFFC
CS.attr = 32-bit code,dp10 // Always switch to 32-bit mode in legacy mode.
CS.base = 0x00000000
CS.limit = 0xFFFFFFFF

SS.sel  = MSR_STAR.SYSCALL_CS + 8
SS.attr = 32-bit stack,dp10
SS.base = 0x00000000
SS.limit = 0xFFFFFFFF

RFLAGS.VM,IF,RF=0

CPL = 0

RIP = temp_RIP
EXIT
```

Related Instructions

SYSRET, SYSENTER, SYSEXIT

rFLAGS Affected

ID	VIP	VIF	AC	VM	RF	NT	IOPL	OF	DF	IF	TF	SF	ZF	AF	PF	CF
M	M	M	M	0	0	M	M	M	M	M	M	M	M	M	M	M
21	20	19	18	17	16	14	13-12	11	10	9	8	7	6	4	2	0
<p>Note: Bits 31-22, 15, 5, 3, and 1 are reserved. A flag set to one or cleared to zero is M (modified). Unaffected flags are blank. Undefined flags are U.</p>																

Exceptions

Exception	Real	Virtual 8086	Protected	Cause of Exception
Invalid opcode, #UD	X	X	X	The SYSCALL and SYSRET instructions are not supported, as indicated by bit 11 of CPUID extended function 8000_0001h.
	X	X	X	The system call extension bit (SCE) of the extended feature enable register (EFER) is set to 0. (The EFER register is MSR C000_0080h.)

SYSENTER System Call

Transfers control to a fixed entry point in an operating system. It is designed for use by system and application software implementing a flat-segment memory model. This instruction is valid only in legacy mode.

Three model-specific registers (MSRs) are used to specify the target address and stack pointers for the SYSENTER instruction, as well as the CS and SS selectors of the called and returned procedures:

- MSR_SYSENTER_CS: Contains the CS selector of the called procedure. The SS selector is set to MSR_SYSENTER_CS + 8.
- MSR_SYSENTER_ESP: Contains the called procedure's stack pointer.
- MSR_SYSENTER_EIP: Contains the offset into the CS of the called procedure.

The hidden portions of the CS and SS segment registers are not loaded from the descriptor table as they would be using a legacy x86 CALL instruction. Instead, the hidden portions are forced by the processor to the following values:

- The CS and SS base values are forced to 0.
- The CS and SS limit values are forced to 4 Gbytes.
- The CS segment attributes are set to execute/read 32-bit code with a CPL of zero.
- The SS segment attributes are set to read/write and expand-up with a 32-bit stack referenced by ESP.

System software must create corresponding descriptor-table entries referenced by the new CS and SS selectors that match the values described above.

The return EIP and application stack are not saved by this instruction. System software must explicitly save that information.

An invalid-opcode exception occurs if this instruction is used in long mode. Software should use the SYSCALL (and SYSRET) instructions in long mode. If SYSENTER is used in real mode, a #GP is raised.

For additional information on this instruction, see “SYSENTER and SYSEXIT (Legacy Mode Only)” in Volume 2.

Mnemonic	Opcode	Description
SYSENTER	0F 34	Call operating system.

Related Instructions

SYSCALL, SYSEXIT, SYSRET

rFLAGS Affected

ID	VIP	VIF	AC	VM	RF	NT	IOPL	OF	DF	IF	TF	SF	ZF	AF	PF	CF
				0						0						
21	20	19	18	17	16	14	13–12	11	10	9	8	7	6	4	2	0

Note: Bits 31–22, 15, 5, 3, and 1 are reserved. A flag set to one or zero is M (modified). Unaffected flags are blank. Undefined flags are U.

Exceptions

Exception	Real	Virtual 8086	Protected	Cause of Exception
Invalid opcode, #UD	X	X	X	The SYSENTER and SYSEXIT instructions are not supported, as indicated by bit 11 of CPUID standard function 1.
			X	This instruction is not recognized in long mode.
General protection, #GP	X			This instruction is not recognized in real mode.
		X	X	MSR_SYSENTER_CS was cleared to 0.

SYSEXIT **System Return**

Returns from the operating system to an application. It is a low-latency system return instruction designed for use by system and application software implementing a flat-segment memory model.

This is a privileged instruction. The current privilege level must be zero to execute this instruction. An invalid-opcode exception occurs if this instruction is used in long mode. Software should use the SYSRET (and SYSCALL) instructions when running in long mode.

When a system procedure performs a SYSEXIT back to application software, the CS selector is updated to point to the second descriptor entry after the SYSENTER CS value (MSR SYSENTER_CS+16). The SS selector is updated to point to the third descriptor entry after the SYSENTER CS value (MSR SYSENTER_CS+24). The CPL is forced to 3, as are the descriptor privilege levels.

The hidden portions of the CS and SS segment registers are not loaded from the descriptor table as they would be using a legacy x86 RET instruction. Instead, the hidden portions are forced by the processor to the following values:

- The CS and SS base values are forced to 0.
- The CS and SS limit values are forced to 4 Gbytes.
- The CS segment attributes are set to 32-bit read/execute at CPL 3.
- The SS segment attributes are set to read/write and expand-up with a 32-bit stack referenced by ESP.

System software must create corresponding descriptor-table entries referenced by the new CS and SS selectors that match the values described above.

The following additional actions result from executing SYSEXIT:

- EIP is loaded from EDX.
- ESP is loaded from ECX.

System software must explicitly load the return address and application software-stack pointer into the EDX and ECX registers prior to executing SYSEXIT.

For additional information on this instruction, see “SYSENTER and SYSEXIT (Legacy Mode Only)” in Volume 2.

Mnemonic	Opcode	Description
SYSEXIT	OF 35	Return from operating system to application.

Related Instructions

SYSCALL, SYSENTER, SYSRET

rFLAGS Affected

ID	VIP	VIF	AC	VM	RF	NT	IOPL	OF	DF	IF	TF	SF	ZF	AF	PF	CF
					0											
21	20	19	18	17	16	14	13–12	11	10	9	8	7	6	4	2	0

Note: Bits 31–22, 15, 5, 3, and 1 are reserved. A flag set to one or cleared to zero is M (modified). Unaffected flags are blank.

Exceptions

Exception	Real	Virtual 8086	Protected	Cause of Exception
Invalid opcode, #UD	X	X	X	The SYSENTER and SYSEXIT instructions are not supported, as indicated by bit 11 of CPUID standard function 1.
			X	This instruction is not recognized in long mode.
General protection, #GP	X	X		This instruction is only recognized in protected mode.
			X	CPL was not 0.
			X	MSR_SYSENTER_CS was cleared to 0.

SYSRET **Fast System Return**

Returns from the operating system to an application. It is a low-latency system return instruction designed for use by system and application software implementing a flat segmentation memory model.

The SYSCALL and SYSRET instructions are low-latency system call and return control-transfer instructions that assume that the operating system implements a flat-segment memory model. By eliminating unneeded checks, and by loading pre-determined values into the CS and SS segment registers (both visible and hidden portions), calls to and returns from the operating system are greatly simplified. These instructions can be used in protected mode and are particularly well-suited for use in 64-bit mode, which requires implementation of a paged, flat-segment memory model.

This instruction has been optimized by reducing the number of checks and memory references that are normally made so that a call or return takes substantially fewer internal clock cycles when compared to the CALL/RET instruction method.

It is assumed that the base, limit, and attributes of the Code Segment will remain flat for all processes and for the operating system, and that only the current privilege level for the selector of the calling process should be changed from a current privilege level of 0 to a new privilege level of 3. It is also assumed (but not checked) that the RPL of the SYSCALL and SYSRET target selectors are set to 0 and 3, respectively.

SYSRET sets the CPL to 3, regardless of the values of bits 49–48 of the star register. SYSRET can only be executed in protected mode at CPL 0. SYSCALL and SYSRET must be enabled by setting EFER.SCE to 1.

It is the responsibility of the operating system to keep the descriptors in memory that correspond to the CS and SS selectors loaded by the SYSCALL and SYSRET instructions consistent with the segment base, limit, and attribute values forced by these instructions.

When a system procedure performs a SYSRET back to application software, the CS selector is updated from bits 63–50 of the STAR register (STAR.SYSRET_CS) as follows:

- If the return is to 32-bit mode (legacy or compatibility), CS is updated with the value of STAR.SYSRET_CS.
- If the return is to 64-bit mode, CS is updated with the value of STAR.SYSRET_CS + 16.

In both cases, the CPL is forced to 3, effectively ignoring STAR bits 49–48. The SS selector is updated to point to the next descriptor-table entry after the CS descriptor (STAR.SYSRET_CS + 8), and its RPL is not forced to 3.

The hidden portions of the CS and SS segment registers are not loaded from the descriptor table as they would be using a legacy x86 RET instruction. Instead, the hidden portions are forced by the processor to the following values:

- The CS base value is forced to 0.
- The CS limit value is forced to 4 Gbytes.
- The CS segment attributes are set to execute-read 32 bits or 64 bits (see below).
- The SS segment base, limit, and attributes are not modified.

When SYSCALLed system software is running in 64-bit mode, it has been entered from either 64-bit mode or compatibility mode. The corresponding SYSRET needs to know the mode to which it must return. Executing SYSRET in non-64-bit mode or with a 16- or 32-bit operand size, returns to 32-bit mode with a 32-bit stack pointer. Executing SYSRET in 64-bit mode with a 64-bit operand size returns to 64-bit mode with a 64-bit stack pointer.

The instruction pointer is updated with the return address based on the operating mode in which SYSRET is executed:

- If returning to 64-bit mode, SYSRET loads RIP with the value of RCX.
- If returning to 32-bit mode, SYSRET loads EIP with the value of ECX.

How SYSRET handles RFLAGS, depends on the processor's operating mode:

- If executed in 64-bit mode, SYSRET loads the lower-32 RFLAGS bits from R11[31:0] and clears the upper 32 RFLAGS bits.
- If executed in legacy mode or compatibility mode, SYSRET sets EFLAGS.IF.

For further details on the SYSCALL and SYSRET instructions and their associated MSR registers (STAR, LSTAR, and CSTAR), see “Fast System Call and Return” in Volume 2.

Mnemonic	Opcode	Description
SYSRET	0F 07	Return from operating system.

Action

// See “Pseudocode Definitions” on page 48.

SYSRET_START:

```

IF (MSR_EFER.SCE = 0)           // Check if syscall/sysret are enabled.
    EXCEPTION [#UD]

IF ((!PROTECTED_MODE) || (CPL != 0))
    EXCEPTION [#GP(0)]           // SYSRET requires protected mode, cp10

IF (64BIT_MODE)
    SYSRET_64BIT_MODE
ELSE // (!64BIT_MODE)
    SYSRET_NON_64BIT_MODE

SYSRET_64BIT_MODE:

IF (OPERAND_SIZE = 64)           // Return to 64-bit mode.
{
    CS.sel = (MSR_STAR.SYSRET_CS + 16) OR 3
    CS.base = 0x00000000
    CS.limit = 0xFFFFFFFF
    CS.attr = 64-bit code,dpl3

    temp_RIP.q = RCX
}
ELSE                               // Return to 32-bit compatibility mode.
{
    CS.sel = MSR_STAR.SYSRET_CS OR 3
    CS.base = 0x00000000
    CS.limit = 0xFFFFFFFF
    CS.attr = 32-bit code,dpl3

    temp_RIP.d = RCX
}

SS.sel = MSR_STAR.SYSRET_CS + 8    // SS selector is changed,
                                   // SS base, limit, attributes unchanged.

RFLAGS.q = R11                    // RF=0,VM=0
CPL = 3

RIP = temp_RIP
EXIT

SYSRET_NON_64BIT_MODE:

CS.sel = MSR_STAR.SYSRET_CS OR 3 // Return to 32-bit legacy protected mode.
CS.base = 0x00000000
CS.limit = 0xFFFFFFFF
CS.attr = 32-bit code,dpl3

temp_RIP.d = RCX

```

```

SS.sel = MSR_STAR.SYSRET_CS + 8 // SS selector is changed.
                                     // SS base, limit, attributes unchanged.
RFLAGS.IF = 1
CPL = 3

RIP = temp_RIP
EXIT

```

Related Instructions

SYSCALL, SYSENTER, SYSEXIT

rFLAGS Affected

ID	VIP	VIF	AC	VM	RF	NT	IOPL	OF	DF	IF	TF	SF	ZF	AF	PF	CF
M	M	M	M		0	M	M	M	M	M	M	M	M	M	M	M
21	20	19	18	17	16	14	13–12	11	10	9	8	7	6	4	2	0

Note: Bits 31–22, 15, 5, 3, and 1 are reserved. A flag set to one or cleared to zero is M (modified). Unaffected flags are blank. Undefined flags are U.

Exceptions

Exception	Real	Virtual 8086	Protected	Cause of Exception
Invalid opcode, #UD	X	X	X	The SYSCALL and SYSRET instructions are not supported, as indicated by bit 11 of CPUID extended function 8000_0001h.
	X	X	X	The system call extension bit (SCE) of the extended feature enable register (EFER) is set to 0. (The EFER register is MSR C000_0080h.)
General protection, #GP	X	X		This instruction is only recognized in protected mode.
			X	CPL was not 0.

UD2 Undefined Operation

Generates an invalid opcode exception. Unlike other undefined opcodes that may be defined as legal instructions in the future, UD2 is guaranteed to stay undefined.

Mnemonic	Opcode	Description
UD2	0F 0B	Raise an invalid opcode exception.

Related Instructions

None

rFLAGS Affected

None

Exceptions

Exception	Real	Virtual 8086	Protected	Cause of Exception
Invalid opcode, #UD	X	X	X	This instruction is not recognized.

VERR Verify Segment for Reads

Verifies whether a code or data segment specified by the segment selector in the 16-bit register or memory operand is readable from the current privilege level. The zero flag (ZF) is set to 1 if the specified segment is readable. Otherwise, ZF is cleared.

A segment is readable if all of the following apply:

- the selector is not a null selector.
- the descriptor is within the GDT or LDT limit.
- the segment is a data segment or readable code segment.
- the descriptor DPL is greater than or equal to both the CPL and RPL, or the segment is a conforming code segment.

The processor does not recognize the VERR instruction in real or virtual-8086 mode.

Mnemonic	Opcode	Description
VERR <i>reg/mem16</i>	0F 00 /4	Set the zero flag (ZF) to 1 if the segment selected can be read.

Related Instructions

ARPL, LAR, LSL, VERW

rFLAGS Affected

ID	VIP	VIF	AC	VM	RF	NT	IOPL	OF	DF	IF	TF	SF	ZF	AF	PF	CF
													M			
21	20	19	18	17	16	14	13–12	11	10	9	8	7	6	4	2	0

Note: Bits 31–22, 15, 5, 3, and 1 are reserved. A flag set to one or cleared to zero is M (modified). Unaffected flags are blank. Undefined flags are U.

Exceptions

Exception	Real	Virtual 8086	Protected	Cause of Exception
Invalid opcode, #UD	X	X		This instruction is only recognized in protected mode.
Stack, #SS			X	A memory address exceeded the stack segment limit or is non-canonical.
General protection, #GP			X	A memory address exceeded a data segment limit or was non-canonical.
			X	A null data segment was used to reference memory.
Page fault, #PF			X	A page fault resulted from the execution of the instruction.
Alignment check, #AC			X	An unaligned memory reference was performed while alignment checking was enabled.

VERW**Verify Segment for Writes**

Verifies whether a data segment specified by the segment selector in the 16-bit register or memory operand is writable from the current privilege level. The zero flag (ZF) is set to 1 if the specified segment is writable. Otherwise, ZF is cleared.

A segment is writable if all of the following apply:

- the selector is not a null selector.
- the descriptor is within the GDT or LDT limit.
- the segment is a writable data segment.
- the descriptor DPL is greater than or equal to both the CPL and RPL.

The processor does not recognize the VERW instruction in real or virtual-8086 mode.

Mnemonic	Opcode	Description
VERW <i>reg/mem16</i>	OF 00 /5	Set the zero flag (ZF) to 1 if the segment selected can be written.

Related Instructions

ARPL, LAR, LSL, VERR

rFLAGS Affected

ID	VIP	VIF	AC	VM	RF	NT	IOPL	OF	DF	IF	TF	SF	ZF	AF	PF	CF
													M			
21	20	19	18	17	16	14	13–12	11	10	9	8	7	6	4	2	0

Note: Bits 31–22, 15, 5, 3, and 1 are reserved. A flag set to one or cleared to zero is M (modified). Unaffected flags are blank. Undefined flags are U.

Exceptions

Exception	Real	Virtual 8086	Protected	Cause of Exception
Invalid opcode, #UD	X	X		This instruction is only recognized in protected mode.
Stack, #SS			X	A memory address exceeded the stack segment limit or was non-canonical.
General protection, #GP			X	A memory address exceeded a data segment limit or was non-canonical.
			X	A null data segment was used to access memory.
Page fault, #PF			X	A page fault resulted from the execution of the instruction.
Alignment check, #AC			X	An unaligned memory reference was performed while alignment checking was enabled.

WBINVD**Writeback and Invalidate Caches**

The WBINVD instruction writes all modified cache lines in the internal caches back to main memory and invalidates (flushes) internal caches. It then causes external caches to write back modified data to main memory; the external caches are subsequently invalidated. After invalidating internal caches, the processor proceeds immediately with the execution of the next instruction without waiting for external hardware to invalidate its caches.

The INVD instruction can be used when cache coherence with memory is not important.

This instruction does not invalidate TLB caches.

This is a privileged instruction. The current privilege level of a procedure invalidating the processor's internal caches must be zero.

WBINVD is a serializing instruction.

Mnemonic	Opcode	Description
WBINVD	0F 09	Write modified cache lines to main memory, invalidate internal caches, and trigger external cache flushes.

Related Instructions

CLFLUSH, INVD

rFLAGS Affected

None

Exceptions

Exception	Real	Virtual 8086	Protected	Cause of Exception
General protection, #GP		X	X	CPL was not 0.

WRMSR Write to Model-Specific Register

Writes data to 64-bit model-specific registers (MSRs). These registers are widely used in performance-monitoring and debugging applications, as well as testability and program execution tracing.

This instruction writes the contents of the EDX:EAX register pair into a 64-bit model-specific register specified in the ECX register. The 32 bits in the EDX register are mapped into the high-order bits of the model-specific register and the 32 bits in EAX form the low-order 32 bits.

This instruction must be executed at a privilege level of 0 or a general protection fault #GP(0) will be raised. This exception is also generated if an attempt is made to specify a reserved or unimplemented model-specific register in ECX.

WRMSR is a serializing instruction.

The CPUID instruction can provide model information useful in determining the existence of a particular MSR.

See Volume 2, *System Programming*, for more information about model-specific registers, machine check architecture, performance monitoring and debug registers.

Mnemonic	Opcode	Description
WRMSR	0F 30	Write EDX:EAX to the MSR specified by ECX.

Related Instructions

RDMSR

rFLAGS Affected

None

Exceptions

Exception	Real	Virtual 8086	Protected	Cause of Exception
Invalid Opcode, #UD	X	X	X	The WRMSR instruction is not supported, as indicated by bit 5 of CPUID function 1 or 8000_0001h.
General protection, #GP		X	X	CPL was not 0.
	X		X	The value in ECX specifies a reserved or unimplemented MSR address.
	X		X	Writing 1 to any bit that must be zero (MBZ) in the MSR.

Appendix A Opcode and Operand Encodings

This section specifies the hexadecimal and/or binary encodings for the opcodes and the implicit operand references used in the AMD64 instruction set. For an overview of the instruction formats to which these encodings apply, see Chapter 1, “Instruction Formats.”

A.1 Opcode-Syntax Notation

The following notation is used in this section to specify opcodes and their operands:

- A* Direct address of operand is encoded in instruction without a ModRM byte. Complex addressing using the SIB byte cannot be done.
- C* Control register specified by the ModRM *reg* field.
- D* Debug register specified by the ModRM *reg* field.
- E* General purpose register or memory operand specified by the ModRM byte. Memory addresses can be computed from a segment register, SIB byte, and/or displacement.
- F* rFLAGS register.
- G* General purpose register specified by the ModRM *reg* field.
- I* Immediate value.
- J* The instruction includes a relative offset that is added to the rIP.
- M* A memory operand specified by the ModRM byte.
- O* The offset of an operand is encoded in the instruction. There is no ModRM byte in the instruction. Complex addressing using the SIB byte cannot be done.
- P* 64-bit MMX register specified by the ModRM *reg* field.
- PR* 64-bit MMX register specified by the ModRM *r/m* field. The ModRM *mod* field must be 11b.

- Q* 64-bit MMX-register or memory operand specified by the ModRM byte. Memory addresses can be computed from a segment register, SIB byte, and/or displacement.
- R* General purpose register specified by the ModRM *r/m* field. The ModRM *mod* field must be 11b.
- S* Segment register specified by the ModRM *reg* field.
- V* 128-bit XMM register specified by the ModRM *reg* field.
- VR* 128-bit XMM register specified by the ModRM *r/m* field. The ModRM *mod* field must be 11b.
- W* A 128-bit XMM register or memory operand specified by the ModRM byte. Memory addresses can be computed from a segment register, SIB byte, and/or displacement.
- X* A memory operand addressed by the DS.rSI registers. Used in string instructions.
- Y* A memory operand addressed by the ES.rDI registers. Used in string instructions.
- a* Two 16-bit or 32-bit memory operands, depending on the effective operand size. Used in the BOUND instruction.
- b* A byte, irrespective of the effective operand size.
- d* A doubleword (32 bits), irrespective of the effective operand size.
- dq* A double-quadword (128 bits), irrespective of the effective operand size.
- p* A 32-bit or 48-bit far pointer, depending on the effective operand size.
- pd* A 128-bit double-precision floating-point vector operand (packed double).
- pi* A 64-bit MMX operand (packed integer).
- ps* A 128-bit single-precision floating-point vector operand (packed single).
- q* A quadword, irrespective of the effective operand size.
- s* A 6-byte or 10-byte pseudo-descriptor.

- sd* A scalar double-precision floating-point operand (scalar double).
- si* A scalar doubleword (32-bit) integer operand (scalar integer).
- ss* A scalar single-precision floating-point operand (scalar single).
- v* A word, doubleword, or quadword, depending on the effective operand size.
- w* A word, irrespective of the effective operand size.
- z* A word if the effective operand size is 16 bits, or a doubleword if the effective operand size is 32 or 64 bits.
- /n* A ModRM-byte *reg* field or SIB-byte *base* field that contains a value (*n*) between zero (binary 000) and 7 (binary 111).

For definitions of the mnemonics used to name registers, see “Summary of Registers and Data Types” on page 30.

A.2 Opcode Encodings

A.2.1 One-Byte Opcodes

Table A-1 on page 372 shows the one-byte opcodes in which the low nibble is in the range 0–7h. Table A-2 on page 373 shows those opcodes in which the low nibble is in the range 8–Fh. In both tables, the rows show the full range (0–Fh) of the high nibble, and the columns show the specified range of the low nibble.

Table A-1. One-Byte Opcodes, Low Nibble 0–7h

Nibble ¹	0	1	2	3	4	5	6	7
0	ADD Eb, Gb Ev, Gv Gb, Eb Gv, Ev AL, Ib rAX, Iz						PUSH ES ³	POP ES ³
1	ADC Eb, Gb Ev, Gv Gb, Eb Gv, Ev AL, Ib rAX, Iz						PUSH SS ³	POP SS ³
2	AND Eb, Gb Ev, Gv Gb, Eb Gv, Ev AL, Ib rAX, Iz						seg ES ⁶	DAA ³
3	XOR Eb, Gb Ev, Gv Gb, Eb Gv, Ev AL, Ib rAX, Iz						seg SS ⁶	AAA ³
4	INC ⁵ eAX eCX eDX eBX eSP eBP eSI eDI							
5	PUSH rAX/r8 rCX/r9 rDX/r10 rBX/r11 rSP/r12 rBP/r13 rSI/r14 rDI/r15							
6	PUSHA/D ³	POPA/D ³	BOUND ³ Gv, Ma	ARPL ³ Ew, Gw MOVSD ⁴ Gv, Ed	seg FS	seg GS	operand size	address size
7	JO Jb	JNO Jb	JB Jb	JNB Jb	JZ Jb	JNZ Jb	JBE Jb	JNBE Jb
8	Group 1 ² Eb, lb Ev, lz Eb, lb ³ Ev, lb				TEST Eb, Gb Ev, Gv		XCHG Eb, Gb Ev, Gv	
9	XCHG r8, rAX NOP rCX/r9, rAX rDX/r10, rAX rBX/r11, rAX rSP/r12, rAX rBP/r13, rAX rSI/r14, rAX rDI/r15, rAX							
A	MOV AL, Ob rAX, Ov Ob, AL Ov, rAX				MOVSB Yb, Xb	MOVSW/D/Q Yv, Xv	CMPSB Xb, Yb	CMPSW/D/Q Xv, Yv
B	MOV AL, lb CL, lb DL, lb BL, lb AH, lb CH, lb DH, lb BH, lb r8b, lb r9b, lb r10b, lb r11b, lb r12b, lb r13b, lb r14b, lb r15b, lb							
C	Group 2 ² Eb, lb Ev, lb		RET near lw		LES ³ Gz, Mp	LDS ³ Gz, Mp	Group 11 ² Eb, lb Ev, lz	
D	Group 2 ² Eb, 1 Ev, 1 Eb, CL Ev, CL				AAM ³	AAD ³	SALC ³	XLAT
E	LOOPNE/NZ Jb	LOOPE/Z Jb	LOOP Jb	Jrcxz Jb	IN AL, lb eAX, lb		OUT lb, AL lb, eAX	
F	LOCK:	INT1 ICE Bkpt	REPNE:	REP: REPE:	HLT	CMC	Group 3 ²	

Note:

1. Rows in this table show the high opcode nibble, columns show the low opcode nibble.
2. An opcode extension is specified in bits 5–3 of the ModRM byte. See “ModRM Extensions to One-Byte and Two-Byte Opcodes” on page 381 for details.
3. Invalid in 64-bit mode.
4. Valid only in 64-bit mode.
5. Used as REX prefixes in 64-bit mode.
6. This is a null prefix in 64-bit mode.

Table A-2. One-Byte Opcodes, Low Nibble 8–Fh

Nibble ¹	8	9	A	B	C	D	E	F
0	Eb, Gb	Ev, Gv	Gb, Eb	Gv, Ev	AL, Ib	rAX, Iz	PUSH CS ³	2-byte opcodes
1	Eb, Gb	Ev, Gv	Gb, Eb	Gv, Ev	AL, Ib	rAX, Iz	PUSH DS ³	POP DS ³
2	Eb, Gb	Ev, Gv	Gb, Eb	Gv, Ev	AL, Ib	rAX, Iz	seg CS ⁶	DAS ³
3	Eb, Gb	Ev, Gv	Gb, Eb	Gv, Ev	AL, Ib	rAX, Iz	seg DS ⁶	AAS ³
4	eAX	eCX	eDX	eBX	eSP	eBP	eSI	eDI
5	rAX/r8	rCX/r9	rDX/r10	rBX/r11	rSP/r12	rBP/r13	rSI/r14	rDI/r15
6	PUSH Iz	IMUL Gv, Ev, Iz	PUSH Ib	IMUL Gv, Ev, Ib	INSB Yb, DX	INSD Yz, DX	OUTSB DX, Xb	OUTSD DX, Xz
7	JS Jb	JNS Jb	JP Jb	JNP Jb	JL Jb	JNL Jb	JLE Jb	JNLE Jb
8	Eb, Gb	Ev, Gv	Gb, Eb	Gv, Ev	Mw/Rv, Sw	LEA Gv, M	MOV Sw, Ew	Group 1a ² Ev
9	CBW, CWDE CDQE	CWD, CDQ, CQO	CALL ³ Ap	WAIT FWAIT	PUSHF/D/Q Fv	POPF/D/Q Fv	SAHF	LAHF
A	TEST AL, Ib	rAX, Iz	STOSB Yb, AL	STOSW/D/Q Yv, rAX	LODSB AL, Xb	LODSW/D/Q rAX, Xv	SCASB AL, Yb	SCASW/D/Q rAX, Yv
B	rAX, Iv r8, Iv	rCX, Iv r9, Iv	rDX, Iv r10, Iv	rBX, Iv r11, Iv	rSP, Iv r12, Iv	rBP, Iv r13, Iv	rSI, Iv r14, Iv	rDI, Iv r15, Iv
C	ENTER Iw, Ib	LEAVE	RET far Iw		INT3	INT Ib	INTO ³	IRET, IRETD IRETQ
D	x87 see Table A-10 on page 387							
E	CALL Jz	Jz	JMP Ap ³	Jb	IN AL, DX eAX, DX		OUT DX, AL DX, eAX	
F	CLC	STC	CLI	STI	CLD	STD	Group 4 ² Eb	Group 5 ²

Note:

1. Rows in this table show the high opcode nibble, columns show the low opcode nibble.
2. An opcode extension is specified in bits 5–3 of the ModRM byte. See “ModRM Extensions to One-Byte and Two-Byte Opcodes” on page 381 for details.
3. Invalid in 64-bit mode.
4. Valid only in 64-bit mode.
5. Used as REX prefixes in 64-bit mode.
6. This is a null prefix in 64-bit mode.

A.2.2 Two-Byte Opcodes

All two-byte opcodes have 0Fh as their first byte. Table A-3 below shows the second byte of the two-byte opcodes in which the second byte's low nibble is in the range 0–7h. Table A-4 on page 377 shows those opcodes in which the second byte's low nibble is in the range 8–Fh. In both tables, the rows show the full range (0–Fh) of the high nibble, and the columns show the low nibble of the opcode. The left-most column shows special-purpose prefix bytes used in many 128-bit and 64-bit instructions to modify the opcode.

Table A-3. Second Byte of Two-Byte Opcodes, Low Nibble 0–7h

Prefix	Nibble ¹	0	1	2	3	4	5	6	7
n/a	0	Group 6 ²	Group 7 ²	LAR Gv, Ew	LSL Gv, Ew	invalid	SYSCALL	CLTS	SYSRET
none	1	MOVUPS Vps, Wps Wps, Vps		MOVLPS Vps, Mq MOVHLPS Vps, VRq	MOVLPS Mq, Vps	UNPCKLPS Vps, Wq	UNPCKHPS Vps, Wq	MOVHPS Vps, Mq MOVLHPS Vps, VRq	MOVHPS Mq, Vps
F3		MOVSS Vdq/ss, Wss Wss, Vss		invalid	invalid	invalid	invalid	invalid	invalid
66		MOVUPD Vpd, Wpd Wpd, Vpd		MOVLDP Vsd, Mq Mq, Vsd		UNPCKLPD Vpd, Wq	UNPCKHPD Vpd, Wq	MOVHPD Vsd, Mq Mq, Vsd	
F2		MOVSD Vdq/sd, Wsd Wsd, Vsd		invalid	invalid	invalid	invalid	invalid	invalid
n/a	2	MOV Rd/q, Cd/q Rd/q, Dd/q Cd/q, Rd/q Dd/q, Rd/q				invalid	invalid	invalid	invalid
n/a	3	WRMSR	RDTSC	RDMSR	RDPIC	SYSENTER ³	SYSEXIT ³	invalid	invalid
n/a	4	CMOVO Gv, Ev	CMOVNO Gv, Ev	CMOVNB Gv, Ev	CMOVNB Gv, Ev	CMOVZ Gv, Ev	CMOVNZ Gv, Ev	CMOVBE Gv, Ev	CMOVNBE Gv, Ev
none	5	MOVMSKPS Gd, VRps	SQRTPS Vps, Wps	RSQRTPS Vps, Wps	RCPSPS Vps, Wps	ANDPS Vps, Wps	ANDNPS Vps, Wps	ORPS Vps, Wps	XORPS Vps, Wps
F3		invalid	SQRTPSS Vss, Wss	RSQRTPSS Vss, Wss	RCPSS Vss, Wss	invalid	invalid	invalid	invalid
66		MOVMSKPD Gd, VRpd	SQRTPD Vpd, Wpd	invalid	invalid	ANDPD Vpd, Wpd	ANDNPD Vpd, Wpd	ORPD Vpd, Wpd	XORPD Vpd, Wpd
F2		invalid	SQRTPSD Vsd, Wsd	invalid	invalid	invalid	invalid	invalid	invalid

Note:

1. All two-byte opcodes begin with an 0Fh byte. Rows in the table show the high nibble of the second opcode bytes, columns show the low nibble of this byte.
2. An opcode extension is specified in bits 5–3 of the ModRM byte. See “ModRM Extensions to One-Byte and Two-Byte Opcodes” on page 381 for details.
3. Invalid in long mode.

Table A-3. Second Byte of Two-Byte Opcodes, Low Nibble 0–7h (continued)

Prefix	Nibble ¹	0	1	2	3	4	5	6	7
none	6	PUNPCKLBW Pq, Qd	PUNPCKLWD Pq, Qd	PUNPCKLDQ Pq, Qd	PACKSSWB Pq, Qq	PCMPGTB Pq, Qq	PCMPGTW Pq, Qq	PCMPGTD Pq, Qq	PACKUSWB Pq, Qq
F3		invalid	invalid	invalid	invalid	invalid	invalid	invalid	invalid
66		PUNPCKLBW Vdq, Wq	PUNPCKLWD Vdq, Wq	PUNPCKLDQ Vdq, Wq	PACKSSWB Vdq, Wdq	PCMPGTB Vdq, Wdq	PCMPGTW Vdq, Wdq	PCMPGTD Vdq, Wdq	PACKUSWB Vdq, Wdq
F2		invalid	invalid	invalid	invalid	invalid	invalid	invalid	invalid
none	7	PSHUFW Pq, Qq, Ib	Group 12 ²	Group 13 ²	Group 14 ²	PCMPEQB Pq, Qq	PCMPEQW Pq, Qq	PCMPEQD Pq, Qq	EMMS
F3		PSHUFHW Vq, Wq, Ib	invalid	invalid	invalid	invalid	invalid	invalid	invalid
66		PSHUFD Vdq, Wdq, Ib	Group 12 ²	Group 13 ²	Group 14 ²	PCMPEQB Vdq, Wdq	PCMPEQW Vdq, Wdq	PCMPEQD Vdq, Wdq	invalid
F2		PSHUFLW Vq, Wq, Ib	invalid	invalid	invalid	invalid	invalid	invalid	invalid
n/a	8	JO Jz	JNO Jz	JB Jz	JNB Jz	JZ Jz	JNZ Jz	JBE Jz	JNBE Jz
n/a	9	SETO Eb	SETNO Eb	SETB Eb	SETNB Eb	SETZ Eb	SETNZ Eb	SETBE Eb	SETNBE Eb
n/a	A	PUSH FS	POP FS	CPUID	BT Ev, Gv	SHLD Ev, Gv, Ib Ev, Gv, CL		invalid	invalid
n/a	B	CMPXCHG Eb, Gb Ev, Gv		LSS Gz, Mp	BTR Ev, Gv	LFS Gz, Mp	LGS Gz, Mp	MOVZX Gv, Eb Gv, Ew	
none	C	XADD Eb, Gb Ev, Gv		CMPPS Vps, Wps, Ib	MOVNTI Md/q, Gd/q	PINSRW Pq, Ew, Ib	PEXTRW Gd, PRq, Ib	SHUFPS Vps, Wps, Ib	Group 9 ² Mq
F3				CMPPS Vss, Wss, Ib	invalid	invalid	invalid	invalid	
66				CMPPD Vpd, Wpd, Ib	invalid	PINSRW Vdq, Ew, Ib	PEXTRW Gd, VRdq, Ib	SHUFPD Vpd, Wpd, Ib	
F2				CMPSD Vsd, Wsd, Ib	invalid	invalid	invalid	invalid	

Note:

1. All two-byte opcodes begin with an 0Fh byte. Rows in the table show the high nibble of the second opcode bytes, columns show the low nibble of this byte.
2. An opcode extension is specified in bits 5–3 of the ModRM byte. See “ModRM Extensions to One-Byte and Two-Byte Opcodes” on page 381 for details.
3. Invalid in long mode.

Table A-3. Second Byte of Two-Byte Opcodes, Low Nibble 0–7h (continued)

Prefix	Nibble ¹	0	1	2	3	4	5	6	7
none	D	invalid	PSRLW Pq, Qq	PSRLD Pq, Qq	PSRLQ Pq, Qq	PADDQ Pq, Qq	PMULLW Pq, Qq	invalid	PMOVMASKB Gd, PRq
F3		invalid	invalid	invalid	invalid	invalid	invalid	MOVQ2DQ Vdq, PRq	invalid
66		invalid	PSRLW Vdq, Wdq	PSRLD Vdq, Wdq	PSRLQ Vdq, Wdq	PADDQ Vdq, Wdq	PMULLW Vdq, Wdq	MOVQ Wq, Vq	PMOVMASKB Gd, VRdq
F2		invalid	invalid	invalid	invalid	invalid	invalid	MOVQ2DQ Pq, VRq	invalid
none	E	PAVGB Pq, Qq	PSRAW Pq, Qq	PSRAD Pq, Qq	PAVGW Pq, Qq	PMULHUW Pq, Qq	PMULHW Pq, Qq	invalid	MOVNTQ Mq, Pq
F3		invalid	invalid	invalid	invalid	invalid	invalid	CVTDQ2PD Vpd, Wq	invalid
66		PAVGB Vdq, Wdq	PSRAW Vdq, Wdq	PSRAD Vdq, Wdq	PAVGW Vdq, Wdq	PMULHUW Vdq, Wdq	PMULHW Vdq, Wdq	CVTTPD2DQ Vq, Wpd	MOVNTDQ Mdq, Vdq
F2		invalid	invalid	invalid	invalid	invalid	invalid	CVTTPD2DQ Vq, Wpd	invalid
none	F	invalid	PSLLW Pq, Qq	PSLLD Pq, Qq	PSLLQ Pq, Qq	PMULUDQ Pq, Qq	PMADDWD Pq, Qq	PSADBW Pq, Qq	MASKMOVQ Pq, PRq
F3		invalid	invalid	invalid	invalid	invalid	invalid	invalid	invalid
66		invalid	PSLLW Vdq, Wdq	PSLLD Vdq, Wdq	PSLLQ Vdq, Wdq	PMULUDQ Vdq, Wdq	PMADDWD Vdq, Wdq	PSADBW Vdq, Wdq	MASK- MOVQDU Vdq, VRdq
F2		invalid	invalid	invalid	invalid	invalid	invalid	invalid	invalid

Note:

1. All two-byte opcodes begin with an 0Fh byte. Rows in the table show the high nibble of the second opcode bytes, columns show the low nibble of this byte.
2. An opcode extension is specified in bits 5–3 of the ModRM byte. See “ModRM Extensions to One-Byte and Two-Byte Opcodes” on page 381 for details.
3. Invalid in long mode.

Table A-4. Second Byte of Two-Byte Opcodes, Low Nibble 8–Fh

Prefix	Nibble ¹	8	9	A	B	C	D	E	F
n/a	0	INVD	WBINVD	invalid	UD2	invalid	Group P ² PREFETCH	FEMMS	3DNow! See "3DNow!™ Opcodes" on page 384
n/a	1	Group 16 ²	NOP ³	NOP ³	NOP ³	NOP ³	NOP ³	NOP ³	NOP ³
none	2	MOVAPS Vps, Wps Wps, Vps		CVTPI2PS Vps, Qq	MOVNTPS Mdq, Vps	CVTTPS2PI Pq, Wps	CVTPS2PI Pq, Wps	UCOMISS Vss, Wss	COMISS Vps, Wps
F3		invalid	invalid	CVTSI2SS Vss, Ed/q	invalid	CVTTSS2SI Gd/q, Wss	CVTSS2SI Gd/q, Wss	invalid	invalid
66		MOVAPD Vpd, Wpd Wpd, Vpd		CVTPI2PD Vpd, Qq	MOVNTPD Mdq, Vpd	CVTTPD2PI Pq, Wpd	CVTPD2PI Pq, Wpd	UCOMISD Vsd, Wsd	COMISD Vpd, Wsd
F2		invalid	invalid	CVTSI2SD Vsd, Ed/q	invalid	CVTSD2SI Gd/q, Wsd	CVTSD2SI Gd/q, Wsd	invalid	invalid
n/a	3	invalid	invalid	invalid	invalid	invalid	invalid	invalid	invalid
n/a	4	CMOVS Gv, Ev	CMOVNS Gv, Ev	CMOVP Gv, Ev	CMOVNP Gv, Ev	CMOVL Gv, Ev	CMOVNL Gv, Ev	CMOVLE Gv, Ev	CMOVNLE Gv, Ev
none	5	ADDPS Vps, Wps	MULPS Vps, Wps	CVTTPS2PD Vpd, Wps	CVTDQ2PS Vps, Wdq	SUBPS Vps, Wps	MINPS Vps, Wps	DIVPS Vps, Wps	MAXPS Vps, Wps
F3		ADDSS Vss, Wss	MULSS Vss, Wss	CVTSS2SD Vsd, Wss	CVTTPS2DQ Vdq, Wps	SUBSS Vss, Wss	MINSS Vss, Wss	DIVSS Vss, Wss	MAXSS Vss, Wss
66		ADDPD Vpd, Wpd	MULPD Vpd, Wpd	CVTPD2PS Vps, Wpd	CVTTPS2DQ Vdq, Wps	SUBPD Vpd, Wpd	MINPD Vpd, Wpd	DIVPD Vpd, Wpd	MAXPD Vpd, Wpd
F2		ADDSD Vsd, Wsd	MULSD Vsd, Wsd	CVTSD2SS Vss, Wsd	invalid	SUBSD Vsd, Wsd	MINSD Vsd, Wsd	DIVSD Vsd, Wsd	MAXSD Vsd, Wsd
none	6	PUNPCK- HBW Pq, Qd	PUNPCK- HWD Pq, Qd	PUNPCK- HDQ Pq, Qd	PACKSSDW Pq, Qq	invalid	invalid	MOVD Pq, Ed/q	MOVQ Pq, Qq
F3		invalid	invalid	invalid	invalid	invalid	invalid	invalid	MOVQDU Vdq, Wdq
66		PUNPCK- HBW Vdq, Wq	PUNPCK- HWD Vdq, Wq	PUNPCK- HDQ Vdq, Wq	PACKSSDW Vdq, Wdq	PUNPCK- LQDQ Vdq, Wq	PUNPCK- HQDQ Vdq, Wq	MOVD Vdq, Ed/q	MOVQDA Vdq, Wdq
F2		invalid	invalid	invalid	invalid	invalid	invalid	invalid	invalid

Note:

1. All two-byte opcodes begin with an 0Fh byte. Rows show high opcode nibble (hex), columns show low opcode nibble in hex.
2. An opcode extension is specified in the ModRM reg field (bits 5–3). See "ModRM Extensions to One-Byte and Two-Byte Opcodes" on page 381 for details.
3. This instruction takes a ModRM byte.

Table A-4. Second Byte of Two-Byte Opcodes, Low Nibble 8–Fh (continued)

Prefix	Nibble ¹	8	9	A	B	C	D	E	F
none	7	invalid	invalid	invalid	invalid	invalid	invalid	MOVD Ed/q, Pd/q	MOVQ Qq, Pq
F3		invalid	invalid	invalid	invalid	invalid	invalid	MOVQ Vq, Wq	MOVDQU Wdq, Vdq
66		invalid	invalid	invalid	invalid	invalid	invalid	MOVD Ed/q, Vd/q	MOVDQA Wdq, Vdq
F2		invalid	invalid	invalid	invalid	invalid	invalid	invalid	invalid
n/a	8	JS Jz	JNS Jz	JP Jz	JNP Jz	JL Jz	JNL Jz	JLE Jz	JNLE Jz
n/a	9	SETS Eb	SETNS Eb	SETP Eb	SETNP Eb	SETL Eb	SETNL Eb	SETLE Eb	SETNLE Eb
n/a	A	PUSH GS	POP GS	RSM	BTS Ev, Gv	SHRD Ev, Gv, Ib Ev, Gv, CL		Group 15 ²	IMUL Gv, Ev
n/a	B	invalid	Group 10 ²	Group 8 ² Ev, Ib	BTC Ev, Gv	BSF Gv, Ev	BSR Gv, Ev	MOVSX Gv, Eb Gv, Ew	
n/a	C	BSWAP rAX/r8 rCX/r9 rDX/r10 rBX/r11 rSP/r12 rBP/r13 rSI/r14 rDI/r15							
none	D	PSUBUSB Pq, Qq	PSUBUSW Pq, Qq	PMINUB Pq, Qq	PAND Pq, Qq	PADDUSB Pq, Qq	PADDUSW Pq, Qq	PMAXUB Pq, Qq	PANDN Pq, Qq
F3		invalid	invalid	invalid	invalid	invalid	invalid	invalid	invalid
66		PSUBUSB Vdq, Wdq	PSUBUSW Vdq, Wdq	PMINUB Vdq, Wdq	PAND Vdq, Wdq	PADDUSB Vdq, Wdq	PADDUSW Vdq, Wdq	PMAXUB Vdq, Wdq	PANDN Vdq, Wdq
F2		invalid	invalid	invalid	invalid	invalid	invalid	invalid	invalid
none	E	PSUBSB Pq, Qq	PSUBSW Pq, Qq	PMINSW Pq, Qq	POR Pq, Qq	PADDUSB Pq, Qq	PADDUSW Pq, Qq	PMAXSW Pq, Qq	PXOR Pq, Qq
F3		invalid	invalid	invalid	invalid	invalid	invalid	invalid	invalid
66		PSUBSB Vdq, Wdq	PSUBSW Vdq, Wdq	PMINSW Vdq, Wdq	POR Vdq, Wdq	PADDUSB Vdq, Wdq	PADDUSW Vdq, Wdq	PMAXSW Vdq, Wdq	PXOR Vdq, Wdq
F2		invalid	invalid	invalid	invalid	invalid	invalid	invalid	invalid

Note:

1. All two-byte opcodes begin with an 0Fh byte. Rows show high opcode nibble (hex), columns show low opcode nibble in hex.
2. An opcode extension is specified in the ModRM reg field (bits 5–3). See “ModRM Extensions to One-Byte and Two-Byte Opcodes” on page 381 for details.
3. This instruction takes a ModRM byte.

Table A-4. Second Byte of Two-Byte Opcodes, Low Nibble 8–Fh (continued)

Prefix	Nibble ¹	8	9	A	B	C	D	E	F
none	F	PSUBB Pq, Qq	PSUBW Pq, Qq	PSUBD Pq, Qq	PSUBQ Pq, Qq	PADDB Pq, Qq	PADDW Pq, Qq	PADDD Pq, Qq	invalid
F3		invalid	invalid	invalid	invalid	invalid	invalid	invalid	invalid
66		PSUBB Vdq, Wdq	PSUBW Vdq, Wdq	PSUBD Vdq, Wdq	PSUBQ Vdq, Wdq	PADDB Vdq, Wdq	PADDW Vdq, Wdq	PADDD Vdq, Wdq	invalid
F2		invalid	invalid	invalid	invalid	invalid	invalid	invalid	invalid

Note:

1. All two-byte opcodes begin with an *OFh* byte. Rows show high opcode nibble (hex), columns show low opcode nibble in hex.
2. An opcode extension is specified in the ModRM reg field (bits 5–3). See “ModRM Extensions to One-Byte and Two-Byte Opcodes” on page 381 for details.
3. This instruction takes a ModRM byte.

A.2.3 rFLAGS Condition Codes for Two-Byte Opcodes

Table A-5 shows the rFLAGS condition codes specified by the low nibble in the second opcode byte of the CMOVcc, Jcc, and SETcc instructions.

Table A-5. rFLAGS Condition Codes for CMOVcc, Jcc, and SETcc

Low Nibble of Second Opcode Byte (hex)	rFLAGS Value	cc Mnemonic	Arithmetic Type	Condition(s)
0	OF = 1	O	Signed	Overflow
1	OF = 0	NO		No Overflow
2	CF = 1	B, C, NAE	Unsigned	Below, Carry, Not Above or Equal
3	CF = 0	NB, NC, AE		Not Below, No Carry, Above or Equal
4	ZF = 1	Z, E		Zero, Equal
5	ZF = 0	NZ, NE		Not Zero, Not Equal
6	CF = 1 or ZF = 1	BE, NA		Below or Equal, Not Above
7	CF = 0 and ZF = 0	NBE, A		Not Below or Equal, Above
8	SF = 1	S	Signed	Sign
9	SF = 0	NS		Not Sign
A	PF = 1	P, PE	n/a	Parity, Parity Even
B	PF = 0	NP, PO		Not Parity, Parity Odd
C	(SF xor OF) = 1	L, NGE	Signed	Less than, Not Greater than or Equal to
D	(SF xor OF) = 0	NL, GE		Not Less than, Greater than or Equal to
E	(SF xor OF) = 1 or ZF = 1	LE, NG		Less than or Equal to, Not Greater than
F	(SF xor OF) = 0 and ZF = 0	NLE, G		Not Less than or Equal to, Greater than

A.2.4 ModRM Extensions to One-Byte and Two-Byte Opcodes

The ModRM byte, which immediately follows the last opcode byte, is used in certain instruction encodings to provide additional opcode bits with which to define the function of the instruction. ModRM bytes have three fields—*mod*, *reg*, and *r/m*, as shown in Figure A-1.

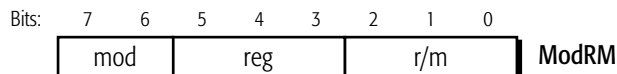

513-325.eps

Figure A-1. ModRM-Byte Fields

In most cases, the *reg* field (bits 5–3) provides the additional bits with which to extend the encodings of the first one or two opcode bytes. In the case of the x87 floating-point instructions, the entire ModRM byte is used to extend the opcode encodings.

Table A-6 on page 382 shows how the ModRM *reg* field is used to extend the range of one-byte and two-byte opcodes. The opcode ranges are organized into *groups* of opcode extensions. The group number is shown in the left-most column of Table A-6. These groups are referenced in the opcodes shown in Table A-1 on page 372 through Table A-4 on page 377. An entry of “n.a.” in the Prefix column means that prefixes are not applicable to the opcodes in that row. Prefixes only apply to certain 128-bit media, 64-bit media, and a few other instructions introduced with the SSE or SSE2 technologies.

The /0 through /7 notation for the ModRM *reg* field (bits 5–3) means that the three-bit field contains a value from zero (binary 000) to 7 (binary 111).

Table A-6. One-Byte and Two-Byte Opcode ModRM Extensions

Group Number	Prefix	Opcode	ModRM reg Field							
			/0	/1	/2	/3	/4	/5	/6	/7
Group 1	n/a	80	ADD Eb, Ib	OR Eb, Ib	ADC Eb, Ib	SBB Eb, Ib	AND Eb, Ib	SUB Eb, Ib	XOR Eb, Ib	CMP Eb, Ib
		81	ADD Ev, Iz	OR Ev, Iz	ADC Ev, Iz	SBB Ev, Iz	AND Ev, Iz	SUB Ev, Iz	XOR Ev, Iz	CMP Ev, Iz
		82	ADD Eb, Ib ²	OR Eb, Ib ²	ADC Eb, Ib ²	SBB Eb, Ib ²	AND Eb, Ib ²	SUB Eb, Ib ²	XOR Eb, Ib ²	CMP Eb, Ib ²
		83	ADD Ev, Ib	OR Ev, Ib	ADC Ev, Ib	SBB Ev, Ib	AND Ev, Ib	SUB Ev, Ib	XOR Ev, Ib	CMP Ev, Ib
Group 1a	n/a	8F	POP Ev	invalid	invalid	invalid	invalid	invalid	invalid	invalid
Group 2	n/a	C0	ROL Eb, Ib	ROR Eb, Ib	RCL Eb, Ib	RCR Eb, Ib	SHL/SAL Eb, Ib	SHR Eb, Ib	SHL/SAL Eb, Ib	SAR Eb, Ib
		C1	ROL Ev, Ib	ROR Ev, Ib	RCL Ev, Ib	RCR Ev, Ib	SHL/SAL Ev, Ib	SHR Ev, Ib	SHL/SAL Ev, Ib	SAR Ev, Ib
		D0	ROL Eb, 1	ROR Eb, 1	RCL Eb, 1	RCR Eb, 1	SHL/SAL Eb, 1	SHR Eb, 1	SHL/SAL Eb, 1	SAR Eb, 1
		D1	ROL Ev, 1	ROR Ev, 1	RCL Ev, 1	RCR Ev, 1	SHL/SAL Ev, 1	SHR Ev, 1	SHL/SAL Ev, 1	SAR Ev, 1
		D2	ROL Eb, CL	ROR Eb, CL	RCL Eb, CL	RCR Eb, CL	SHL/SAL Eb, CL	SHR Eb, CL	SHL/SAL Eb, CL	SAR Eb, CL
		D3	ROL Ev, CL	ROR Ev, CL	RCL Ev, CL	RCR Ev, CL	SHL/SAL Ev, CL	SHR Ev, CL	SHL/SAL Ev, CL	SAR Ev, CL
Group 3	n/a	F6	TEST Eb, Ib		NOT Eb	NEG Eb	MUL Eb	IMUL Eb	DIV Eb	IDIV Eb
		F7	TEST Ev, Iz		NOT Ev	NEG Ev	MUL Ev	IMUL Ev	DIV Ev	IDIV Ev
Group 4	n/a	FE	INC Eb	DEC Eb	invalid	invalid	invalid	invalid	invalid	invalid
Group 5	n/a	FF	INC Ev	DEC Ev	CALL Ev	CALL Ep	JMP Ev	JMP Ep	PUSH Ev	invalid
Group 6	n/a	0F 00	SLDT Mw/Rv	STR Mw/Rv	LLDT Ew	LTR Ew	VERR Ew	VERW Ew	invalid	invalid
Group 7	n/a	0F 01	SGDT Ms	SIDT Ms	LGDT Ms	LIDT Ms	SMSW Mw/Rv	invalid	LMSW Ew	INVLPG Mb SWAPGS ¹
Group 8	n/a	0F BA	invalid	invalid	invalid	invalid	BT Ev, Ib	BTS Ev, Ib	BTR Ev, Ib	BTC Ev, Ib

Note:

1. See Table A-7 on page 384 for ModRM extensions of this two-byte opcode to encode SWAPGS.
2. Invalid in 64-bit mode.
3. See Table A-7 on page 384 for ModRM extensions of this two-byte opcode to encode LFENCE, MFENCE, and SFENCE.
4. This instruction takes a ModRM byte.
5. Reserved prefetch encodings are aliased to the /0 encoding (PREFETCH Exclusive) for future compatibility.

Table A-6. One-Byte and Two-Byte Opcode ModRM Extensions (continued)

Group Number	Prefix	Opcode	ModRM reg Field								
			/0	/1	/2	/3	/4	/5	/6	/7	
Group 9	n/a	0F C7	invalid	CMPXCHG8B Mq	invalid	invalid	invalid	invalid	invalid	invalid	invalid
Group 10	n/a	0F B9	invalid	invalid	invalid	invalid	invalid	invalid	invalid	invalid	invalid
Group 11	n/a	C6	MOV Eb,lb	invalid	invalid	invalid	invalid	invalid	invalid	invalid	invalid
	n/a	C7	MOV Ev,lz	invalid	invalid	invalid	invalid	invalid	invalid	invalid	invalid
Group 12	none	0F 71	invalid	invalid	PSRLW PRq, lb	invalid	PSRAW PRq, lb	invalid	PSSLW PRq, lb	invalid	invalid
	66		invalid	invalid	PSRLW VRdq, lb	invalid	PSRAW VRdq, lb	invalid	PSSLW VRdq, lb	invalid	invalid
	F2, F3		invalid	invalid	invalid	invalid	invalid	invalid	invalid	invalid	invalid
Group 13	none	0F 72	invalid	invalid	PSRLD PRq, lb	invalid	PSRAD PRq, lb	invalid	PSLLD PRq, lb	invalid	invalid
	66		invalid	invalid	PSRLD VRdq, lb	invalid	PSRAD VRdq, lb	invalid	PSLLD VRdq, lb	invalid	invalid
	F2, F3		invalid	invalid	invalid	invalid	invalid	invalid	invalid	invalid	invalid
Group 14	none	0F 73	invalid	invalid	PSRLQ PRq, lb	invalid	invalid	invalid	PSSLQ PRq, lb	invalid	invalid
	66		invalid	invalid	PSRLQ VRdq, lb	PSRLDQ VRdq, lb	invalid	invalid	PSSLQ VRdq, lb	PSLLDQ VRdq, lb	invalid
	F2, F3		invalid	invalid	invalid	invalid	invalid	invalid	invalid	invalid	invalid
Group 15	none	0F AE	FXSAVE M	FXRSTOR M	LDMXCSR Md	STMXCSR Md	invalid	LFENCE ³	MFENCE ³	SFENCE ³ CLFLUSH Mb	invalid
	66, F2, F3		invalid	invalid	invalid	invalid	invalid	invalid	invalid	invalid	invalid
Group 16	n/a.	0F 18	PREFETCH NTA	PREFETCH T0	PREFETCH T1	PREFETCH T2	NOP ⁴	NOP ⁴	NOP ⁴	NOP ⁴	invalid
Group P	n/a.	0F 0D	PREFETCH Exclusive	PREFETCH Modified	Prefetch Reserved ⁵	PREFETCH Modified	Prefetch Reserved ⁵	Prefetch Reserved ⁵	Prefetch Reserved ⁵	Prefetch Reserved ⁵	Prefetch Reserved ⁵

Note:

1. See Table A-7 on page 384 for ModRM extensions of this two-byte opcode to encode SWAPGS.
2. Invalid in 64-bit mode.
3. See Table A-7 on page 384 for ModRM extensions of this two-byte opcode to encode LFENCE, MFENCE, and SFENCE.
4. This instruction takes a ModRM byte.
5. Reserved prefetch encodings are aliased to the /0 encoding (PREFETCH Exclusive) for future compatibility.

A.2.5 ModRM Extensions to SWAPGS and CLFLUSH Opcodes

Table A-7 shows the ModRM *r/m* field encodings for the 0F 01 and 0F AE opcodes, shown in Table A-6. The 0F 01 /7 opcode is shared by the INVLPG and SWAPGS instructions and the 0F AE opcode is shared by the LFENCE, MFENCE, and SFENCE instructions. The opcodes are differentiated by the fact that the binary value of the ModRM *mod* field is always 11 for SWAPGS and the xFENCE instructions, and any value except 11 for INVLPG and CLFLUSH. The SWAPGS opcode is only valid in 64-bit mode.

Table A-7. SWAPGS and xFENCE ModRM Extensions

Opcode	ModRM <i>r/m</i> Field							
	0	1	2	3	4	5	6	7
0F 01 /7 mod=11	SWAPGS	invalid	invalid	invalid	invalid	invalid	invalid	invalid
0F AE /5 mod=11	LFENCE							
0F AE /6 mod=11	MFENCE							
0F AE /7 mod=11	SFENCE							

A.2.6 3DNow!™ Opcodes

The 64-bit media instructions include the MMX™ instructions and the AMD 3DNow!™ instructions. The MMX instructions are encoded using two opcode bytes, as described in “Two-Byte Opcodes” on page 374.

The 3DNow! instructions are encoded using two 0Fh opcode bytes and an immediate byte that is located at the last byte position of the instruction encoding. Thus, the format for 3DNow! instructions is:

0Fh 0Fh [ModRM] [SIB] [displacement] *imm8_opcode*

Table A-8 on page 385 and Table A-9 on page 386 show the immediate byte following the opcode bytes for 3DNow! instructions. In these tables, rows show the high nibble of the immediate byte, and columns show the low nibble of the immediate byte. Table A-8 shows the immediate bytes whose low nibble is in the range 0–7h. Table A-9 shows the same for immediate bytes whose low nibble is in the range 8–Fh.

Byte values shown as *reserved* in these tables have implementation-specific functions, which can include an invalid-opcode exception.

Table A-8. Immediate Byte for 3DNow!™ Opcodes, Low Nibble 0–7h

Nibble ¹	0	1	2	3	4	5	6	7
0	reserved	reserved	reserved	reserved	reserved	reserved	reserved	reserved
1	reserved	reserved	reserved	reserved	reserved	reserved	reserved	reserved
2	reserved	reserved	reserved	reserved	reserved	reserved	reserved	reserved
3	reserved	reserved	reserved	reserved	reserved	reserved	reserved	reserved
4	reserved	reserved	reserved	reserved	reserved	reserved	reserved	reserved
5	reserved	reserved	reserved	reserved	reserved	reserved	reserved	reserved
6	reserved	reserved	reserved	reserved	reserved	reserved	reserved	reserved
7	reserved	reserved	reserved	reserved	reserved	reserved	reserved	reserved
8	reserved	reserved	reserved	reserved	reserved	reserved	reserved	reserved
9	PFCMPGE Pq, Qq	reserved	reserved	reserved	PFCMPGE Pq, Qq	reserved	PFCMPGE Pq, Qq	PFCMPGE Pq, Qq
A	PFCMPGT Pq, Qq	reserved	reserved	reserved	PFCMPGT Pq, Qq	reserved	PFCMPGT Pq, Qq	PFCMPGT Pq, Qq
B	PFCMPEQ Pq, Qq	reserved	reserved	reserved	PFCMPEQ Pq, Qq	reserved	PFCMPEQ Pq, Qq	PFCMPEQ Pq, Qq
C	reserved	reserved	reserved	reserved	reserved	reserved	reserved	reserved
D	reserved	reserved	reserved	reserved	reserved	reserved	reserved	reserved
E	reserved	reserved	reserved	reserved	reserved	reserved	reserved	reserved
F	reserved	reserved	reserved	reserved	reserved	reserved	reserved	reserved

Note:

1. All 3DNow!™ opcodes consist of two 0Fh bytes. This table shows the immediate byte for 3DNow! opcodes. Rows show the high nibble of the immediate byte. Columns show the low nibble of the immediate byte.

Table A-9. Immediate Byte for 3DNow!™ Opcodes, Low Nibble 8–Fh

Nibble ¹	8	9	A	B	C	D	E	F
0	reserved	reserved	reserved	reserved	PI2FW Pq, Qq	PI2FD Pq, Qq	reserved	reserved
1	reserved	reserved	reserved	reserved	PF2IW Pq, Qq	PF2ID Pq, Qq	reserved	reserved
2	reserved	reserved	reserved	reserved	reserved	reserved	reserved	reserved
3	reserved	reserved	reserved	reserved	reserved	reserved	reserved	reserved
4	reserved	reserved	reserved	reserved	reserved	reserved	reserved	reserved
5	reserved	reserved	reserved	reserved	reserved	reserved	reserved	reserved
6	reserved	reserved	reserved	reserved	reserved	reserved	reserved	reserved
7	reserved	reserved	reserved	reserved	reserved	reserved	reserved	reserved
8	reserved	reserved	PFNACC Pq, Qq	reserved	reserved	reserved	PFPNACC Pq, Qq	reserved
9	reserved	reserved	PFSUB Pq, Qq	reserved	reserved	reserved	PFADD Pq, Qq	reserved
A	reserved	reserved	PFSUBR Pq, Qq	reserved	reserved	reserved	PFACC Pq, Qq	reserved
B	reserved	reserved	reserved	PSWAPD Pq, Qq	reserved	reserved	reserved	PAVGUSB Pq, Qq
C	reserved	reserved	reserved	reserved	reserved	reserved	reserved	reserved
D	reserved	reserved	reserved	reserved	reserved	reserved	reserved	reserved
E	reserved	reserved	reserved	reserved	reserved	reserved	reserved	reserved
F	reserved	reserved	reserved	reserved	reserved	reserved	reserved	reserved

Note:

1. All 3DNow!™ opcodes consist of two 0Fh bytes. This table shows the immediate byte for 3DNow! opcodes. Rows show the high nibble of the immediate byte. Columns show the low nibble of the immediate byte.

A.2.7 x87 Encodings

All x87 instructions begin with an opcode byte in the range D8h to DFh, as shown in Table A-2 on page 373. These opcodes are followed by a ModRM byte that further defines the opcode. Table A-10 shows both the opcode byte and the ModRM byte for each x87 instruction.

There are two significant ranges for the ModRM byte for x87 opcodes: 00–BFh and C0–FFh. When the value of the ModRM byte falls within the first range, 00–BFh, the opcode uses only the *reg* field to further define the opcode. When the value of the ModRM byte falls within the second range, C0–FFh, the opcode uses the entire ModRM byte to further define the opcode.

Byte values shown as *reserved* or *invalid* in Table A-10 have implementation-specific functions, which can include an invalid-opcode exception.

Table A-10. x87 Opcodes and ModRM Extensions

Opcode	ModRM <i>mod</i> Field	ModRM <i>reg</i> Field							
		/0	/1	/2	/3	/4	/5	/6	/7
D8	!11	00–BF							
		FADD mem32real	FMUL mem32real	FCOM mem32real	FCOMP mem32real	FSUB mem32real	FSUBR mem32real	FDIV mem32real	FDIVR mem32real
	11	C0	C8	D0	D8	E0	E8	F0	F8
		FADD ST(0), ST(0)	FMUL ST(0), ST(0)	FCOM ST(0), ST(0)	FCOMP ST(0), ST(0)	FSUB ST(0), ST(0)	FSUBR ST(0), ST(0)	FDIV ST(0), ST(0)	FDIVR ST(0), ST(0)
		C1	C9	D1	D9	E1	E9	F1	F9
		FADD ST(0), ST(1)	FMUL ST(0), ST(1)	FCOM ST(0), ST(1)	FCOMP ST(0), ST(1)	FSUB ST(0), ST(1)	FSUBR ST(0), ST(1)	FDIV ST(0), ST(1)	FDIVR ST(0), ST(1)
		C2	CA	D2	DA	E2	EA	F2	FA
		FADD ST(0), ST(2)	FMUL ST(0), ST(2)	FCOM ST(0), ST(2)	FCOMP ST(0), ST(2)	FSUB ST(0), ST(2)	FSUBR ST(0), ST(2)	FDIV ST(0), ST(2)	FDIVR ST(0), ST(2)
		C3	CB	D3	DB	E3	EB	F3	FB
		FADD ST(0), ST(3)	FMUL ST(0), ST(3)	FCOM ST(0), ST(3)	FCOMP ST(0), ST(3)	FSUB ST(0), ST(3)	FSUBR ST(0), ST(3)	FDIV ST(0), ST(3)	FDIVR ST(0), ST(3)
C4	CC	D4	DC	E4	EC	F4	FC		
FADD ST(0), ST(4)	FMUL ST(0), ST(4)	FCOM ST(0), ST(4)	FCOMP ST(0), ST(4)	FSUB ST(0), ST(4)	FSUBR ST(0), ST(4)	FDIV ST(0), ST(4)	FDIVR ST(0), ST(4)		
C5	CD	D5	DD	E5	ED	F5	FD		
FADD ST(0), ST(5)	FMUL ST(0), ST(5)	FCOM ST(0), ST(5)	FCOMP ST(0), ST(5)	FSUB ST(0), ST(5)	FSUBR ST(0), ST(5)	FDIV ST(0), ST(5)	FDIVR ST(0), ST(5)		
C6	CE	D6	DE	E6	EE	F6	FE		
FADD ST(0), ST(6)	FMUL ST(0), ST(6)	FCOM ST(0), ST(6)	FCOMP ST(0), ST(6)	FSUB ST(0), ST(6)	FSUBR ST(0), ST(6)	FDIV ST(0), ST(6)	FDIVR ST(0), ST(6)		
C7	CF	D7	DF	E7	EF	F7	FF		
FADD ST(0), ST(7)	FMUL ST(0), ST(7)	FCOM ST(0), ST(7)	FCOMP ST(0), ST(7)	FSUB ST(0), ST(7)	FSUBR ST(0), ST(7)	FDIV ST(0), ST(7)	FDIVR ST(0), ST(7)		

Table A-10. x87 Opcodes and ModRM Extensions (continued)

Opcode	ModRM mod Field	ModRM reg Field							
		/0	/1	/2	/3	/4	/5	/6	/7
D9	!11	00–BF							
		FLD mem32real	invalid	FST mem32real	FSTP mem32real	FLDENV mem14/28e nv	FLDCW mem16	FSTENV mem14/28e nv	FSTCW mem16
	11	C0 FLD ST(0), ST(0)	C8 FXCH ST(0), ST(0)	D0 FNOP	D8 reserved	E0 FCHS	E8 FLD1	F0 F2XM1	F8 FPREM
		C1 FLD ST(0), ST(1)	C9 FXCH ST(0), ST(1)	D1 invalid	D9 reserved	E1 FABS	E9 FLDL2T	F1 FYL2X	F9 FYL2XP1
		C2 FLD ST(0), ST(2)	CA FXCH ST(0), ST(2)	D2 invalid	DA reserved	E2 invalid	EA FLDL2E	F2 FPTAN	FA FSQRT
		C3 FLD ST(0), ST(3)	CB FXCH ST(0), ST(3)	D3 invalid	DB reserved	E3 invalid	EB FLDPI	F3 FPATAN	FB FSINCOS
		C4 FLD ST(0), ST(4)	CC FXCH ST(0), ST(4)	D4 invalid	DC reserved	E4 FTST	EC FLDLG2	F4 EXTRACT	FC FRNDINT
		C5 FLD ST(0), ST(5)	CD FXCH ST(0), ST(5)	D5 invalid	DD reserved	E5 FXAM	ED FLDLN2	F5 FPREM1	FD FSCALE
		C6 FLD ST(0), ST(6)	CE FXCH ST(0), ST(6)	D6 invalid	DE reserved	E6 invalid	EE FLDZ	F6 FDECSTP	FE FSIN
		C7 FLD ST(0), ST(7)	CF FXCH ST(0), ST(7)	D7 invalid	DF reserved	E7 invalid	EF invalid	F7 FINCSTP	FF FCOS

Table A-10. x87 Opcodes and ModRM Extensions (continued)

Opcode	ModRM <i>mod</i> Field	ModRM <i>reg</i> Field							
		/0	/1	/2	/3	/4	/5	/6	/7
DA	!11	00–BF							
		FIADD mem32int	FIMUL mem32int	FICOM mem32int	FICOMP mem32int	FISUB mem32int	FISUBR mem32int	FIDIV mem32int	FIDIVR mem32int
	11	C0 FCMOVB ST(0), ST(0)	C8 FCMOVE ST(0), ST(0)	D0 FCMOVBE ST(0), ST(0)	D8 FCMOVU ST(0), ST(0)	E0 invalid	E8 invalid	F0 invalid	F8 invalid
		C1 FCMOVB ST(0), ST(1)	C9 FCMOVE ST(0), ST(1)	D1 FCMOVBE ST(0), ST(1)	D9 FCMOVU ST(0), ST(1)	E1 invalid	E9 FUCOMPP	F1 invalid	F9 invalid
		C2 FCMOVB ST(0), ST(2)	CA FCMOVE ST(0), ST(2)	D2 FCMOVBE ST(0), ST(2)	DA FCMOVU ST(0), ST(2)	E2 invalid	EA invalid	F2 invalid	FA invalid
		C3 FCMOVB ST(0), ST(3)	CB FCMOVE ST(0), ST(3)	D3 FCMOVBE ST(0), ST(3)	DB FCMOVU ST(0), ST(3)	E3 invalid	EB invalid	F3 invalid	FB invalid
		C4 FCMOVB ST(0), ST(4)	CC FCMOVE ST(0), ST(4)	D4 FCMOVBE ST(0), ST(4)	DC FCMOVU ST(0), ST(4)	E4 invalid	EC invalid	F4 invalid	FC invalid
		C5 FCMOVB ST(0), ST(5)	CD FCMOVE ST(0), ST(5)	D5 FCMOVBE ST(0), ST(5)	DD FCMOVU ST(0), ST(5)	E5 invalid	ED invalid	F5 invalid	FD invalid
		C6 FCMOVB ST(0), ST(6)	CE FCMOVE ST(0), ST(6)	D6 FCMOVBE ST(0), ST(6)	DE FCMOVU ST(0), ST(6)	E6 invalid	EE invalid	F6 invalid	FE invalid
		C7 FCMOVB ST(0), ST(7)	CF FCMOVE ST(0), ST(7)	D7 FCMOVBE ST(0), ST(7)	DF FCMOVU ST(0), ST(7)	E7 invalid	EF invalid	F7 invalid	FF invalid

Table A-10. x87 Opcodes and ModRM Extensions (continued)

Opcode	ModRM <i>mod</i> Field	ModRM <i>reg</i> Field							
		/0	/1	/2	/3	/4	/5	/6	/7
DB	!11	00–BF							
		FILD mem32int	invalid	FIST mem32int	FISTP mem32int	invalid	FLD mem80real	invalid	FSTP mem80real
	11	C0 FCMOVNB ST(0), ST(0)	C8 FCMOVNE ST(0), ST(0)	D0 FCMOVNBE ST(0), ST(0)	D8 FCMOVNU ST(0), ST(0)	E0 reserved	E8 FUCOMI ST(0), ST(0)	F0 FCOMI ST(0), ST(0)	F8 invalid
		C1 FCMOVNB ST(0), ST(1)	C9 FCMOVNE ST(0), ST(1)	D1 FCMOVNBE ST(0), ST(1)	D9 FCMOVNU ST(0), ST(1)	E1 reserved	E9 FUCOMI ST(0), ST(1)	F1 FCOMI ST(0), ST(1)	F9 invalid
		C2 FCMOVNB ST(0), ST(2)	CA FCMOVNE ST(0), ST(2)	D2 FCMOVNBE ST(0), ST(2)	DA FCMOVNU ST(0), ST(2)	E2 FCLEX	EA FUCOMI ST(0), ST(2)	F2 FCOMI ST(0), ST(2)	FA invalid
		C3 FCMOVNB ST(0), ST(3)	CB FCMOVNE ST(0), ST(3)	D3 FCMOVNBE ST(0), ST(3)	DB FCMOVNU ST(0), ST(3)	E3 FINIT	EB FUCOMI ST(0), ST(3)	F3 FCOMI ST(0), ST(3)	FB invalid
		C4 FCMOVNB ST(0), ST(4)	CC FCMOVNE ST(0), ST(4)	D4 FCMOVNBE ST(0), ST(4)	DC FCMOVNU ST(0), ST(4)	E4 reserved	EC FUCOMI ST(0), ST(4)	F4 FCOMI ST(0), ST(4)	FC invalid
		C5 FCMOVNB ST(0), ST(5)	CD FCMOVNE ST(0), ST(5)	D5 FCMOVNBE ST(0), ST(5)	DD FCMOVNU ST(0), ST(5)	E5 invalid	ED FUCOMI ST(0), ST(5)	F5 FCOMI ST(0), ST(5)	FD invalid
		C6 FCMOVNB ST(0), ST(6)	CE FCMOVNE ST(0), ST(6)	D6 FCMOVNBE ST(0), ST(6)	DE FCMOVNU ST(0), ST(6)	E6 invalid	EE FUCOMI ST(0), ST(6)	F6 FCOMI ST(0), ST(6)	FE invalid
		C7 FCMOVNB ST(0), ST(7)	CF FCMOVNE ST(0), ST(7)	D7 FCMOVNBE ST(0), ST(7)	DF FCMOVNU ST(0), ST(7)	E7 invalid	EF FUCOMI ST(0), ST(7)	F7 FCOMI ST(0), ST(7)	FF invalid

Table A-10. x87 Opcodes and ModRM Extensions (continued)

Opcode	ModRM <i>mod</i> Field	ModRM <i>reg</i> Field							
		/0	/1	/2	/3	/4	/5	/6	/7
DC	!11	00–BF							
		FADD m64real	FMUL m64real	FCOM m64real	FCOMP m64real	FSUB m64real	FSUBR m64real	FDIV m64real	FDIVR m64real
	11	C0 FADD ST(0), ST(0)	C8 FMUL ST(0), ST(0)	D0 reserved	D8 reserved	E0 FSUBR ST(0), ST(0)	E8 FSUB ST(0), ST(0)	F0 FDIVR ST(0), ST(0)	F8 FDIV ST(0), ST(0)
		C1 FADD ST(1), ST(0)	C9 FMUL ST(1), ST(0)	D1 reserved	D9 reserved	E1 FSUBR ST(1), ST(0)	E9 FSUB ST(1), ST(0)	F1 FDIVR ST(1), ST(0)	F9 FDIV ST(1), ST(0)
		C2 FADD ST(2), ST(0)	CA FMUL ST(2), ST(0)	D2 reserved	DA reserved	E2 FSUBR ST(2), ST(0)	EA FSUB ST(2), ST(0)	F2 FDIVR ST(2), ST(0)	FA FDIV ST(2), ST(0)
		C3 FADD ST(3), ST(0)	CB FMUL ST(3), ST(0)	D3 reserved	DB reserved	E3 FSUBR ST(3), ST(0)	EB FSUB ST(3), ST(0)	F3 FDIVR ST(3), ST(0)	FB FDIV ST(3), ST(0)
		C4 FADD ST(4), ST(0)	CC FMUL ST(4), ST(0)	D4 reserved	DC reserved	E4 FSUBR ST(4), ST(0)	EC FSUB ST(4), ST(0)	F4 FDIVR ST(4), ST(0)	FC FDIV ST(4), ST(0)
		C5 FADD ST(5), ST(0)	CD FMUL ST(5), ST(0)	D5 reserved	DD reserved	E5 FSUBR ST(5), ST(0)	ED FSUB ST(5), ST(0)	F5 FDIVR ST(5), ST(0)	FD FDIV ST(5), ST(0)
		C6 FADD ST(6), ST(0)	CE FMUL ST(6), ST(0)	D6 reserved	DE reserved	E6 FSUBR ST(6), ST(0)	EE FSUB ST(6), ST(0)	F6 FDIVR ST(6), ST(0)	FE FDIV ST(6), ST(0)
		C7 FADD ST(7), ST(0)	CF FMUL ST(7), ST(0)	D7 reserved	DF reserved	E7 FSUBR ST(7), ST(0)	EF FSUB ST(7), ST(0)	F7 FDIVR ST(7), ST(0)	FF FDIV ST(7), ST(0)

Table A-10. x87 Opcodes and ModRM Extensions (continued)

Opcode	ModRM <i>mod</i> Field	ModRM <i>reg</i> Field							
		/0	/1	/2	/3	/4	/5	/6	/7
DD	!11	00–BF							
		FLD m64real	invalid	FST m64real	FSTP m64real	FRSTOR mem98/108 env	invalid	FSAVE mem98/108 env	FSTSW mem16
	11	C0 FFREE ST(0)	C8 reserved	D0 FST ST(0)	D8 FSTP ST(0)	E0 FUCOM ST(0), ST(0)	E8 FUCOMP ST(0)	F0 invalid	F8 invalid
		C1 FFREE ST(1)	C9 reserved	D1 FST ST(1)	D9 FSTP ST(1)	E1 FUCOM ST(1), ST(0)	E9 FUCOMP ST(1)	F1 invalid	F9 invalid
		C2 FFREE ST(2)	CA reserved	D2 FST ST(2)	DA FSTP ST(2)	E2 FUCOM ST(2), ST(0)	EA FUCOMP ST(2)	F2 invalid	FA invalid
		C3 FFREE ST(3)	CB reserved	D3 FST ST(3)	DB FSTP ST(3)	E3 FUCOM ST(3), ST(0)	EB FUCOMP ST(3)	F3 invalid	FB invalid
		C4 FFREE ST(4)	CC reserved	D4 FST ST(4)	DC FSTP ST(4)	E4 FUCOM ST(4), ST(0)	EC FUCOMP ST(4)	F4 invalid	FC invalid
		C5 FFREE ST(5)	CD reserved	D5 FST ST(5)	DD FSTP ST(5)	E5 FUCOM ST(5), ST(0)	ED FUCOMP ST(5)	F5 invalid	FD invalid
		C6 FFREE ST(6)	CE reserved	D6 FST ST(6)	DE FSTP ST(6)	E6 FUCOM ST(6), ST(0)	EE FUCOMP ST(6)	F6 invalid	FE invalid
		C7 FFREE ST(7)	CF reserved	D7 FST ST(7)	DF FSTP ST(7)	E7 FUCOM ST(7), ST(0)	EF FUCOMP ST(7)	F7 invalid	FF invalid

Table A-10. x87 Opcodes and ModRM Extensions (continued)

Opcode	ModRM <i>mod</i> Field	ModRM <i>reg</i> Field							
		/0	/1	/2	/3	/4	/5	/6	/7
DE	!11	00–BF							
		FIADD mem16int	FIMUL mem16int	FICOM mem16int	FICOMP mem16int	FISUB mem16int	FISUBR mem16int	FIDIV mem16int	FIDIVR mem16int
	11	C0 FADDP ST(0), ST(0)	C8 FMULP ST(0), ST(0)	D0 reserved	D8 invalid	E0 FSUBRP ST(0), ST(0)	E8 FSUBP ST(0), ST(0)	F0 FDIVRP ST(0), ST(0)	F8 FDIVP ST(0), ST(0)
		C1 FADDP ST(1), ST(0)	C9 FMULP ST(1), ST(0)	D1 reserved	D9 FCOMPP	E1 FSUBRP ST(1), ST(0)	E9 FSUBP ST(1), ST(0)	F1 FDIVRP ST(1), ST(0)	F9 FDIVP ST(1), ST(0)
		C2 FADDP ST(2), ST(0)	CA FMULP ST(2), ST(0)	D2 reserved	DA invalid	E2 FSUBRP ST(2), ST(0)	EA FSUBP ST(2), ST(0)	F2 FDIVRP ST(2), ST(0)	FA FDIVP ST(2), ST(0)
		C3 FADDP ST(3), ST(0)	CB FMULP ST(3), ST(0)	D3 reserved	DB invalid	E3 FSUBRP ST(3), ST(0)	EB FSUBP ST(3), ST(0)	F3 FDIVRP ST(3), ST(0)	FB FDIVP ST(3), ST(0)
		C4 FADDP ST(4), ST(0)	CC FMULP ST(4), ST(0)	D4 reserved	DC invalid	E4 FSUBRP ST(4), ST(0)	EC FSUBP ST(4), ST(0)	F4 FDIVRP ST(4), ST(0)	FC FDIVP ST(4), ST(0)
		C5 FADDP ST(5), ST(0)	CD FMULP ST(5), ST(0)	D5 reserved	DD invalid	E5 FSUBRP ST(5), ST(0)	ED FSUBP ST(5), ST(0)	F5 FDIVRP ST(5), ST(0)	FD FDIVP ST(5), ST(0)
		C6 FADDP ST(6), ST(0)	CE FMULP ST(6), ST(0)	D6 reserved	DE invalid	E6 FSUBRP ST(6), ST(0)	EE FSUBP ST(6), ST(0)	F6 FDIVRP ST(6), ST(0)	FE FDIVP ST(6), ST(0)
		C7 FADDP ST(7), ST(0)	CF FMULP ST(7), ST(0)	D7 reserved	DF invalid	E7 FSUBRP ST(7), ST(0)	EF FSUBP ST(7), ST(0)	F7 FDIVRP ST(7), ST(0)	FF FDIVP ST(7), ST(0)

Table A-10. x87 Opcodes and ModRM Extensions (continued)

Opcode	ModRM <i>mod</i> Field	ModRM <i>reg</i> Field							
		/0	/1	/2	/3	/4	/5	/6	/7
DF	!11	00–BF							
		FILD mem16int	invalid	FIST mem16int	FISTP mem16int	FBLD mem80dec	FILD m64int	FBSTP mem80dec	FISTP m64int
	11	C0 reserved	C8 reserved	D0 reserved	D8 reserved	E0 FSTSW AX	E8 FUCOMIP ST(0), ST(0)	F0 FCOMIP ST(0), ST(0)	F8 invalid
		C1 reserved	C9 reserved	D1 reserved	D9 reserved	E1 invalid	E9 FUCOMIP ST(0), ST(1)	F1 FCOMIP ST(0), ST(1)	F9 invalid
		C2 reserved	CA reserved	D2 reserved	DA reserved	E2 invalid	EA FUCOMIP ST(0), ST(2)	F2 FCOMIP ST(0), ST(2)	FA invalid
		C3 reserved	CB reserved	D3 reserved	DB reserved	E3 invalid	EB FUCOMIP ST(0), ST(3)	F3 FCOMIP ST(0), ST(3)	FB invalid
		C4 reserved	CC reserved	D4 reserved	DC reserved	E4 invalid	EC FUCOMIP ST(0), ST(4)	F4 FCOMIP ST(0), ST(4)	FC invalid
		C5 reserved	CD reserved	D5 reserved	DD reserved	E5 invalid	ED FUCOMIP ST(0), ST(5)	F5 FCOMIP ST(0), ST(5)	FD invalid
		C6 reserved	CE reserved	D6 reserved	DE reserved	E6 invalid	EE FUCOMIP ST(0), ST(6)	F6 FCOMIP ST(0), ST(6)	FE invalid
		C7 reserved	CF reserved	D7 reserved	DF reserved	E7 invalid	EF FUCOMIP ST(0), ST(7)	F7 FCOMIP ST(0), ST(7)	FF invalid

A.2.8 rFLAGS Condition Codes for x87 Opcodes

Table A-11 shows the rFLAGS condition codes specified by the opcode and ModRM bytes of the FCMOV cc instructions.

Table A-11. rFLAGS Condition Codes for FCMOV cc

Opcode (hex)	ModRM <i>mod</i> Field	ModRM <i>reg</i> Field	rFLAGS Value	cc Mnemonic	Condition
DA	11	000	CF = 1	B	Below
		001	ZF = 1	E	Equal
		010	CF = 1 or ZF = 1	BE	Below or Equal
		011	PF = 1	U	Unordered
DB		000	CF = 0	NB	Not Below
		001	ZF = 0	NE	Not Equal
		010	CF = 0 and ZF = 0	NBE	Not Below or Equal
		011	PF = 0	NU	Not Unordered

A.3 Operand Encodings

Register and memory operands are encoded using the *mode-register-memory* (ModRM) and the *scale-index-base* (SIB) bytes that follow the opcodes. In some instructions, the ModRM byte is followed by an SIB byte, which defines the instruction's memory-addressing mode for the complex-addressing modes.

A.3.1 ModRM Operand References

Figure A-2 on page 396 shows the format of a ModRM byte. There are three fields—*mod*, *reg*, and *r/m*. The *reg* field not only provides additional opcode bits—as described above beginning with “ModRM Extensions to One-Byte and Two-Byte Opcodes” on page 381 and ending with “x87 Encodings” on page 386—but is also used with the other two fields to specify operands. The *mod* and *r/m* fields are used together with each other and, in 64-bit mode, with the REX.R and REX.B bits of the REX prefix, to specify the location of the instruction's operands and certain of the possible addressing modes (specifically, the non-complex modes).

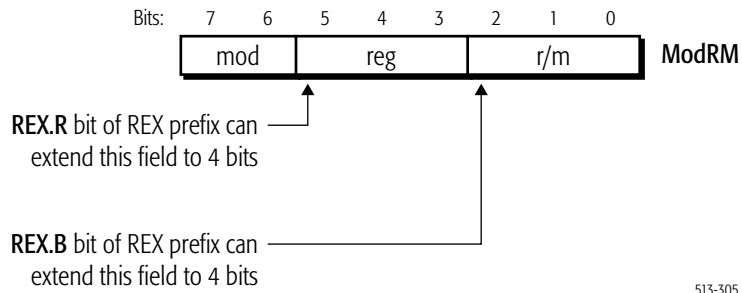

513-305.eps

Figure A-2. ModRM-Byte Format

The two sections below describe the ModRM operand encodings, first for 32-bit and 64-bit references, and then for 16-bit references.

16-Bit Register and Memory References. Table A-12 shows the notation and encoding conventions for register references using the ModRM *reg* field. This table is comparable to Table A-14 on page 399 but applies only when the address-size is 16-bit. Table A-13 on page 397 shows the notation and encoding conventions for 16-bit memory references using the ModRM byte. This table is comparable to Table A-15 on page 400.

Table A-12. ModRM Register References, 16-Bit Addressing

Mnemonic Notation	ModRM <i>reg</i> Field							
	/0	/1	/2	/3	/4	/5	/6	/7
reg8	AL	CL	DL	BL	AH	CH	DH	BH
reg16	AX	CX	DX	BX	SP	BP	SI	DI
reg32	EAX	ECX	EDX	EBX	ESP	EBP	ESI	EDI
mmx	MMX0	MMX1	MMX2	MMX3	MMX4	MMX5	MMX6	MMX7
xmm	XMM0	XMM1	XMM2	XMM3	XMM4	XMM5	XMM6	XMM7
sReg	ES	CS	SS	DS	FS	GS	reserved	reserved
cReg	CR0	CR1	CR2	CR3	CR4	CR5	CR6	CR7
dReg	DR0	DR1	DR2	DR3	DR4	DR5	DR6	DR7

Table A-13. ModRM Memory References, 16-Bit Addressing

Effective Address ¹	ModRM mod Field (binary)	ModRM reg Field ²								ModRM r/m Field (binary)
		/0	/1	/2	/3	/4	/5	/6	/7	
		Complete ModRM Byte (hex)								
[BX+SI]	00	00	08	10	18	20	28	30	38	000
[BX+DI]		01	09	11	19	21	29	31	39	001
[BP+SI]		02	0A	12	1A	22	2A	32	3A	010
[BP+DI]		03	0B	13	1B	23	2B	33	3B	011
[SI]		04	0C	14	1C	24	2C	34	3C	100
[DI]		05	0D	15	1D	25	2D	35	3D	101
[disp16]		06	0E	16	1E	26	2E	36	3E	110
[BX]		07	0F	17	1F	27	2F	37	3F	111
[BX+SI+disp8]	01	40	48	50	58	60	68	70	78	000
[BX+DI+disp8]		41	49	51	59	61	69	71	79	001
[BP+SI+disp8]		42	4A	52	5A	62	6A	72	7A	010
[BP+DI+disp8]		43	4B	53	5B	63	6B	73	7B	011
[SI+disp8]		44	4C	54	5C	64	6C	74	7C	100
[DI+disp8]		45	4D	55	5D	65	6D	75	7D	101
[BP+disp8]		46	4E	56	5E	66	6E	76	7E	110
[BX+disp8]		47	4F	57	5F	67	6F	77	7F	111
[BX+SI+disp16]	10	80	88	90	98	A0	A8	B0	B8	000
[BX+DI+disp16]		81	89	91	99	A1	A9	B1	B9	001
[BP+SI+disp16]		82	8A	92	9A	A2	AA	B2	BA	010
[BP+DI+disp16]		83	8B	93	9B	A3	AB	B3	BB	011
[SI+disp16]		84	8C	94	9C	A4	AC	B4	BC	100
[DI+disp16]		85	8D	95	9D	A5	AD	B5	BD	101
[BP+disp16]		86	8E	96	9E	A6	AE	B6	BE	110
[BX+disp16]		87	8F	97	9F	A7	AF	B7	BF	111

Note:

- In these combinations, "disp8" and "disp16" indicate an 8-bit or 16-bit signed displacement.
- See Table A-12 for complete specification of ModRM "reg" field.

Table A-13. ModRM Memory References, 16-Bit Addressing (continued)

Effective Address ¹	ModRM mod Field (binary)	ModRM reg Field ²								ModRM r/m Field (binary)
		/0	/1	/2	/3	/4	/5	/6	/7	
		Complete ModRM Byte (hex)								
AL/AX/EAX/MMX0/XMM0	11	C0	C8	D0	D8	E0	E8	F0	F8	000
CL/CX/ECX/MMX1/XMM1		C1	C9	D1	D9	E1	E9	F1	F9	001
DL/DX/EDX/MMX2/XMM2		C2	CA	D2	DA	E2	EA	F2	FA	010
BL/BX/EBX/MMX3/XMM3		C3	CB	D3	DB	E3	EB	F3	FB	011
AH/SP/ESP/MMX4/XMM4		C4	CC	D4	DC	E4	EC	F4	FC	100
CH/BP/EBP/MMX5/XMM5		C5	CD	D5	DD	E5	ED	F5	FD	101
DH/SI/ESI/MMX6/XMM6		C6	CE	D6	DE	E6	EE	F6	FE	110
BH/DI/EDI/MMX7/XMM7		C7	CF	D7	DF	E7	EF	F7	FF	111

Note:

1. In these combinations, “disp8” and “disp16” indicate an 8-bit or 16-bit signed displacement.
2. See Table A-12 for complete specification of ModRM “reg” field.

Register and Memory References for 32-Bit and 64-Bit Addressing.

Table A-14 on page 399 shows the encoding for 32-bit and 64-bit register references using the ModRM *reg* field. The first nine rows of Table A-14 show references when the REX.R bit is cleared to 0, and the last nine rows show references when the REX.R bit is set to 1. In this table, *Mnemonic Notation* means the syntax notation shown in “Mnemonic Syntax” on page 43 for a register, and *ModRM Notation (/r)* means the opcode-syntax notation shown in “Opcode Syntax” on page 46 for the register.

Table A-15 on page 400 shows the encoding for 32-bit and 64-bit memory references using the ModRM byte. This table describes 32-bit and 64-bit addressing, with the REX.B bit set or cleared. The *Effective Address* is shown in the two left-most columns, followed by the binary encoding of the ModRM-byte *mod* field, followed by the eight possible hex values of the complete ModRM byte (one value for each binary encoding of the ModRM-byte *reg* field), followed by the binary encoding of the ModRM *r/m* field.

The /0 through /7 notation for the ModRM *reg* field (bits 5–3) means that the three-bit field contains a value from zero (binary 000) to 7 (binary 111).

Table A-14. ModRM Register References, 32-Bit and 64-Bit Addressing

Mnemonic Notation	REX.R Bit	ModRM <i>reg</i> Field							
		/0	/1	/2	/3	/4	/5	/6	/7
reg8	0	AL	CL	DL	BL	AH/SPL	CH/BPL	DH/SIL	BH/DIL
reg16		AX	CX	DX	BX	SP	BP	SI	DI
reg32		EAX	ECX	EDX	EBX	ESP	EBP	ESI	EDI
reg64		RAX	RCX	RDX	RBX	RSP	RBP	RSI	RDI
mmx		MMX0	MMX1	MMX2	MMX3	MMX4	MMX5	MMX6	MMX7
xmm		XMM0	XMM1	XMM2	XMM3	XMM4	XMM5	XMM6	XMM7
sReg		ES	CS	SS	DS	FS	GS	reserved	reserved
cReg		CR0	CR1	CR2	CR3	CR4	CR5	CR6	CR7
dReg		DR0	DR1	DR2	DR3	DR4	DR5	DR6	DR7
reg8	1	R8B	R9B	R10B	R11B	R12B	R13B	R14B	R15B
reg16		R8W	R9W	R10W	R11W	R12W	R13W	R14W	R15W
reg32		R8D	R9D	R10D	R11D	R12D	R13D	R14D	R15D
reg64		R8	R9	R10	R11	R12	R13	R14	R15
mmx		MMX0	MMX1	MMX2	MMX3	MMX4	MMX5	MMX6	MMX7
xmm		XMM8	XMM9	XMM10	XMM11	XMM12	XMM13	XMM14	XMM15
sReg		ES	CS	SS	DS	FS	GS	reserved	reserved
cReg		CR8	CR9	CR10	CR11	CR12	CR13	CR14	CR15
dReg		DR8	DR9	DR10	DR11	DR12	DR13	DR14	DR15

Table A-15. ModRM Memory References, 32-Bit and 64-Bit Addressing

Effective Address ¹		ModRM mod Field (binary)	ModRM reg Field ³								ModRM r/m Field (binary)
			/0	/1	/2	/3	/4	/5	/6	/7	
REX.B = 0	REX.B = 1		Complete ModRM Byte (hex)								
[rAX]	[r8]	00	00	08	10	18	20	28	30	38	000
[rCX]	[r9]		01	09	11	19	21	29	31	39	001
[rDX]	[r10]		02	0A	12	1A	22	2A	32	3A	010
[rBX]	[r11]		03	0B	13	1B	23	2B	33	3B	011
[SIB] ⁴	[SIB] ⁴		04	0C	14	1C	24	2C	34	3C	100
[RIP+disp32] or [disp32] ²	[rIP+disp32] or [disp32] ²		05	0D	15	1D	25	2D	35	3D	101
[rSI]	[r14]		06	0E	16	1E	26	2E	36	3E	110
[rDI]	[r15]		07	0F	17	1F	27	2F	37	3F	111
[rAX+disp8]	[r8+disp8]	01	40	48	50	58	60	68	70	78	000
[rCX+disp8]	[r9+disp8]		41	49	51	59	61	69	71	79	001
[rDX+disp8]	[r10+disp8]		42	4A	52	5A	62	6A	72	7A	010
[rBX+disp8]	[r11+disp8]		43	4B	53	5B	63	6B	73	7B	011
[SIB+disp8] ⁴	[SIB+disp8] ⁴		44	4C	54	5C	64	6C	74	7C	100
[rBP+disp8]	[r13+disp8]		45	4D	55	5D	65	6D	75	7D	101
[rSI+disp8]	[r14+disp8]		46	4E	56	5E	66	6E	76	7E	110
[rDI+disp8]	[r15+disp8]		47	4F	57	5F	67	6F	77	7F	111
[rAX+disp32]	[r8+disp32]	10	80	88	90	98	A0	A8	B0	B8	000
[rCX+disp32]	[r9+disp32]		81	89	91	99	A1	A9	B1	B9	001
[rDX+disp32]	[r10+disp32]		82	8A	92	9A	A2	AA	B2	BA	010
[rBX+disp32]	[r11+disp32]		83	8B	93	9B	A3	AB	B3	BB	011
[SIB+disp32] ⁴	[SIB+disp32] ⁴		84	8C	94	9C	A4	AC	B4	BC	100
[rBP+disp32]	[r13+disp32]		85	8D	95	9D	A5	AD	B5	BD	101
[rSI+disp32]	[r14+disp32]		86	8E	96	9E	A6	AE	B6	BE	110
[rDI+disp32]	[r15+disp32]		87	8F	97	9F	A7	AF	B7	BF	111

Note:

1. In these combinations, "disp8" and "disp32" indicate an 8-bit or 32-bit signed displacement.
2. In 64-bit mode, the effective address is [RIP+disp32]. In all other modes, the effective address is [disp32]. If the address-size prefix is used in 64-bit mode to override 64-bit addressing, the [RIP+disp32] effective address is truncated after computation to 64 bits.
3. See Table A-14 for complete specification of ModRM "reg" field.
4. An SIB byte follows the ModRM byte to identify the memory operand.

Table A-15. ModRM Memory References, 32-Bit and 64-Bit Addressing (continued)

Effective Address ¹		ModRM mod Field (binary)	ModRM reg Field ³								ModRM r/m Field (binary)
			/0	/1	/2	/3	/4	/5	/6	/7	
REX.B = 0	REX.B = 1		Complete ModRM Byte (hex)								
AL/rAX/MMX0/XMM0	r8/MMX0/XMM8	11	C0	C8	D0	D8	E0	E8	F0	F8	000
CL/rCX/MMX1/XMM1	r9/MMX1/XMM9		C1	C9	D1	D9	E1	E9	F1	F9	001
DL/rDX/MMX2/XMM2	r10/MMX2/XMM10		C2	CA	D2	DA	E2	EA	F2	FA	010
BL/rBX/MMX3/XMM3	r11/MMX3/XMM11		C3	CB	D3	DB	E3	EB	F3	FB	011
AH/SPL/rSP/MMX4/XMM4	r12/MMX4/XMM12		C4	CC	D4	DC	E4	EC	F4	FC	100
CH/BPL/rBP/MMX5/XMM5	r13/MMX5/XMM13		C5	CD	D5	DD	E5	ED	F5	FD	101
DH/SIL/rSI/MMX6/XMM6	r14/MMX6/XMM14		C6	CE	D6	DE	E6	EE	F6	FE	110
BH/DIL/rDI/MMX7/XMM7	r15/MMX7/XMM15		C7	CF	D7	DF	E7	EF	F7	FF	111

Note:

1. In these combinations, “disp8” and “disp32” indicate an 8-bit or 32-bit signed displacement.
2. In 64-bit mode, the effective address is [RIP+disp32]. In all other modes, the effective address is [disp32]. If the address-size prefix is used in 64-bit mode to override 64-bit addressing, the [RIP+disp32] effective address is truncated after computation to 64 bits.
3. See Table A-14 for complete specification of ModRM “reg” field.
4. An SIB byte follows the ModRM byte to identify the memory operand.

A.3.2 SIB Operand References

Figure A-3 on page 402 shows the format of a scale-index-base (SIB) byte. Some instructions have an SIB byte following their ModRM byte to define memory addressing for the complex-addressing modes described in “Effective Addresses” in Volume 1. The SIB byte has three fields—*scale*, *index*, and *base*—that define the scale factor, index-register number, and base-register number for 32-bit and 64-bit complex addressing modes. In 64-bit mode, the REX.B and REX.X bits extend the encoding of the SIB byte’s *base* and *index* fields.

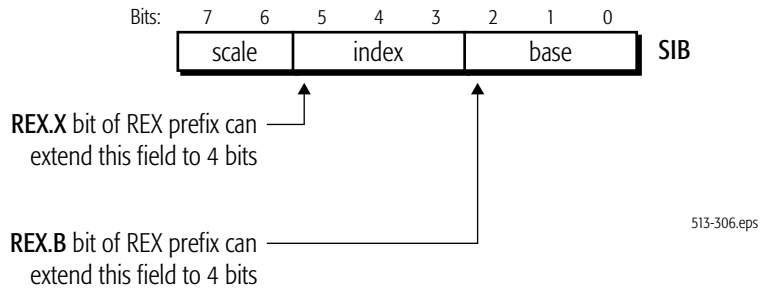

Figure A-3. SIB Byte Format

Table A-16 shows the encodings for the SIB byte’s *base* field, which specifies the base register for addressing. Table A-17 on page 403 shows the encodings for the effective address referenced by a complete SIB byte, including its *scale* and *index* fields. The /0 through /7 notation for the SIB *base* field means that the three-bit field contains a value between zero (binary 000) and 7 (binary 111).

Table A-16. SIB *base* Field References

REX.B Bit	ModRM <i>mod</i> Field	SIB <i>base</i> Field							
		/0	/1	/2	/3	/4	/5	/6	/7
0	00	rAX	rCX	rDX	rBX	rSP	<i>disp32</i>	rSI	rDI
	01						rBP+ <i>disp8</i>		
	10						rBP+ <i>disp32</i>		
1	00	r8	r9	r10	r11	r12	<i>disp32</i>	r14	r15
	01						r13+ <i>disp8</i>		
	10						r13+ <i>disp32</i>		

Table A-17. SIB Memory References

Effective Address		SIB scale Field	SIB index Field	SIB base Field ¹								
				REX.B = 0:	rAX	rCX	rDX	rBX	rSP	note ¹	rSI	rDI
REX.X = 0		REX.X = 1		REX.B = 1:	r8	r9	r10	r11	r12	note ¹	r14	r15
					/0	/1	/2	/3	/4	/5	/6	/7
				Complete SIB Byte (hex)								
[rAX+base]	[r8+base]	00	000	00	01	02	03	04	05	06	07	
[rCX+base]	[r9+base]		001	08	09	0A	0B	0C	0D	0E	0F	
[rDX+base]	[r10+base]		010	10	11	12	13	14	15	16	17	
[rBX+base]	[r11+base]		011	18	19	1A	1B	1C	1D	1E	1F	
[base]	[r12+base]		100	20	21	22	23	24	25	26	27	
[rBP+base]	[r13+base]		101	28	29	2A	2B	2C	2D	2E	2F	
[rSI+base]	[r14+base]		110	30	31	32	33	34	35	36	37	
[rDI+base]	[r15+base]		111	38	39	3A	3B	3C	3D	3E	3F	
[rAX*2+base]	[r8*2+base]	01	000	40	41	42	43	44	45	46	47	
[rCX*2+base]	[r9*2+base]		001	48	49	4A	4B	4C	4D	4E	4F	
[rDX*2+base]	[r10*2+base]		010	50	51	52	53	54	55	56	57	
[rBX*2+base]	[r11*2+base]		011	58	59	5A	5B	5C	5D	5E	5F	
[base]	[r12*2+base]		100	60	61	62	63	64	65	66	67	
[rBP*2+base]	[r13*2+base]		101	68	69	6A	6B	6C	6D	6E	6F	
[rSI*2+base]	[r14*2+base]		110	70	71	72	73	74	75	76	77	
[rDI*2+base]	[r15*2+base]		111	78	79	7A	7B	7C	7D	7E	7F	
[rAX*4+base]	[r8*4+base]	10	000	80	81	82	83	84	85	86	87	
[rCX*4+base]	[r9*4+base]		001	88	89	8A	8B	8C	8D	8E	8F	
[rDX*4+base]	[r10*4+base]		010	90	91	92	93	94	95	96	97	
[rBX*4+base]	[r11*4+base]		011	98	99	9A	9B	9C	9D	9E	9F	
[base]	[r12*4+base]		100	A0	A1	A2	A3	A4	A5	A6	A7	
[rBP*4+base]	[r13*4+base]		101	A8	A9	AA	AB	AC	AD	AE	AF	
[rSI*4+base]	[r14*4+base]		110	B0	B1	B2	B3	B4	B5	B6	B7	
[rDI*4+base]	[r15*4+base]		111	B8	B9	BA	BB	BC	BD	BE	BF	

Note:

1. See Table A-16 on page 402 for complete specification of SIB "base" field.

Table A-17. SIB Memory References (continued)

Effective Address		SIB scale Field	SIB index Field	SIB base Field ¹								
				REX.B = 0:	rAX	rCX	rDX	rBX	rSP	note ¹	rSI	rDI
				REX.B = 1:	r8	r9	r10	r11	r12	note ¹	r14	r15
					/0	/1	/2	/3	/4	/5	/6	/7
REX.X = 0	REX.X = 1			Complete SIB Byte (hex)								
[rAX*8+base]	[r8*8+base]	11	000	C0	C1	C2	C3	C4	C5	C6	C7	
[rCX*8+base]	[r9*8+base]		001	C8	C9	CA	CB	CC	CD	CE	CF	
[rDX*8+base]	[r10*8+base]		010	D0	D1	D2	D3	D4	D5	D6	D7	
[rBX*8+base]	[r11*8+base]		011	D8	D9	DA	DB	DC	DD	DE	DF	
[base]	[r12*8+base]		100	E0	E1	E2	E3	E4	E5	E6	E7	
[rBP*8+base]	[r13*8+base]		101	E8	E9	EA	EB	EC	ED	EE	EF	
[rSI*8+base]	[r14*8+base]		110	F0	F1	F2	F3	F4	F5	F6	F7	
[rDI*8+base]	[r15*8+base]		111	F8	F9	FA	FB	FC	FD	FE	FF	

Note:

- See Table A-16 on page 402 for complete specification of SIB "base" field.

Appendix B General-Purpose Instructions in 64-Bit Mode

This appendix provides details of the general-purpose instructions in 64-bit mode and its differences from legacy and compatibility modes. The appendix covers only the general-purpose instructions (those described in *Chapter 3, “General-Purpose Instruction Reference”*). It does not cover the 128-bit media, 64-bit media, or x87 floating-point instructions because those instructions are not affected by 64-bit mode, other than in the access by such instructions to extended GPR and XMM registers when using a REX prefix.

B.1 General Rules for 64-Bit Mode

In 64-bit mode, the following general rules apply to instructions and their operands:

- **“Promoted to 64 Bit”**: If an instruction’s operand size (16-bit or 32-bit) in legacy and compatibility modes depends on the CS.D bit and the operand-size override prefix, then the operand-size choices in 64-bit mode are extended from 16-bit and 32-bit to include 64 bits (with a REX prefix), or the operand size is fixed at 64 bits. Such instructions are said to be “*Promoted to 64 bits*” in Table B-1. However, byte-operand opcodes of such instructions are not promoted.
- **Byte-Operand Opcodes Not Promoted**: As stated above in “Promoted to 64 Bit”, byte-operand opcodes of promoted instructions are not promoted. Those opcodes continue to operate only on bytes.
- **Fixed Operand Size**: If an instruction’s operand size is fixed in legacy mode (thus, independent of CS.D and prefix overrides), that operand size is usually fixed at the same size in 64-bit mode. For example, CPUID operates on 32-bit operands, irrespective of attempts to override the operand size.
- **Default Operand Size**: The default operand size for most instructions is 32 bits, and a REX prefix must be used to change the operand size to 64 bits. However, two groups of instructions default to 64-bit operand size and do not need a REX prefix: (1) near branches and (2) all instructions,

except far branches, that implicitly reference the RSP. See Table B-5 on page 438 for a list of all instructions that default to 64-bit operand size.

- **Zero-Extension of 32-Bit Results:** Operations on 32-bit operands in 64-bit mode zero-extend the high 32 bits of 64-bit GPR destination registers.
- **No Extension of 8-Bit and 16-Bit Results:** Operations on 8-bit and 16-bit operands in 64-bit mode leave the high 56 or 48 bits, respectively, of 64-bit GPR destination registers unchanged.
- **Shift and Rotate Counts:** When the operand size is 64 bits, shifts and rotates use one additional bit (6 bits total) to specify shift-count or rotate-count, allowing 64-bit shifts and rotates.
- **Immediates:** The maximum size of immediate operands is 32 bits, except that 64-bit immediates can be MOVED into 64-bit GPRs. In 64-bit mode, when the operand size is 64 bits, immediates are sign-extended to 64 bits during use, but their actual size (for value representation) remains a maximum of 32 bits.
- **Displacements:** The maximum size of an address displacement is 32 bits. In 64-bit mode, displacements are sign-extended to 64 bits during use, but their actual size (for value representation) remains a maximum of 32 bits.
- **Undefined High 32 Bits After Mode Change:** The processor does not preserve the upper 32 bits of the 64-bit GPRs across switches from 64-bit mode to compatibility or legacy modes. In compatibility or legacy mode, the upper 32 bits of the GPRs are undefined and not accessible to software.

B.2 Operation and Operand Size in 64-Bit Mode

Table B-1 on page 407 lists the integer instructions, showing operand size in 64-bit mode and the state of the high 32 bits of destination registers when 32-bit operands are used. Opcodes, such as byte-operand versions of several instructions, that do not appear in Table B-1 are covered by the general rules described in “General Rules for 64-Bit Mode” on page 405.

Table B-1. Operations and Operands in 64-Bit Mode

Instruction and Opcode (hex) ¹	Type of Operation ²	Default Operand Size ³	For 32-Bit Operand Size ⁴	For 64-Bit Operand Size ⁴
AAA - ASCII Adjust after Addition 37	INVALID IN 64-BIT MODE (invalid-opcode exception)			
AAD - ASCII Adjust AX before Division D5	INVALID IN 64-BIT MODE (invalid-opcode exception)			
AAM - ASCII Adjust AX after Multiply D4	INVALID IN 64-BIT MODE (invalid-opcode exception)			
AAS - ASCII Adjust AL after Subtraction 3F	INVALID IN 64-BIT MODE (invalid-opcode exception)			
ADC —Add with Carry 11 13 15 81 /2 83 /2	Promoted to 64 bits.	32 bits	Zero-extends 32-bit register results to 64 bits.	
Note:				
1. See “General Rules for 64-Bit Mode” on page 405, for opcodes that do not appear in this table.				
2. The type of operation, excluding considerations of operand size or extension of results. See “General Rules for 64-Bit Mode” on page 405 for definitions of “Promoted to 64 bits” and related topics.				
3. If “Type of Operation” is 64 bits, a REX prefix is needed for 64-bit operand size, unless the instruction size defaults to 64 bits. If the operand size is fixed, operand-size overrides are silently ignored.				
4. Special actions in 64-bit mode, in addition to legacy-mode actions. Zero or sign extensions apply only to result operands, not source operands. Unless otherwise stated, 8-bit and 16-bit results leave the high 56 or 48 bits, respectively, of 64-bit destination registers unchanged. Immediates and branch displacements are sign-extended to 64 bits.				
5. Any pointer registers (rDI, rSI) or count registers (rCX) are address-sized and default to 64 bits. For 32-bit address size, any pointer and count registers are zero-extended to 64 bits.				
6. The default operand size can be overridden to 16 bits with 66h prefix, but there is no 32-bit operand-size override in 64-bit mode.				

Table B-1. Operations and Operands in 64-Bit Mode (continued)

Instruction and Opcode (hex) ¹	Type of Operation ²	Default Operand Size ³	For 32-Bit Operand Size ⁴	For 64-Bit Operand Size ⁴
ADD —Signed or Unsigned Add 01 03 05 81 /0 83 /0	Promoted to 64 bits.	32 bits	Zero-extends 32-bit register results to 64 bits.	
AND —Logical AND 21 23 25 81 /4 83 /4	Promoted to 64 bits.	32 bits	Zero-extends 32-bit register results to 64 bits.	
ARPL - Adjust Requestor Privilege Level 63	OPCODE USED as MOVSD in 64-BIT MODE			
BOUND - Check Array Against Bounds 62	INVALID IN 64-BIT MODE (invalid-opcode exception)			
BSF —Bit Scan Forward 0F BC	Promoted to 64 bits.	32 bits	Zero-extends 32-bit register results to 64 bits.	

Note:

1. See "General Rules for 64-Bit Mode" on page 405, for opcodes that do not appear in this table.
2. The type of operation, excluding considerations of operand size or extension of results. See "General Rules for 64-Bit Mode" on page 405 for definitions of "Promoted to 64 bits" and related topics.
3. If "Type of Operation" is 64 bits, a REX prefix is needed for 64-bit operand size, unless the instruction size defaults to 64 bits. If the operand size is fixed, operand-size overrides are silently ignored.
4. Special actions in 64-bit mode, in addition to legacy-mode actions. Zero or sign extensions apply only to result operands, not source operands. Unless otherwise stated, 8-bit and 16-bit results leave the high 56 or 48 bits, respectively, of 64-bit destination registers unchanged. Immediates and branch displacements are sign-extended to 64 bits.
5. Any pointer registers (rDI, rSI) or count registers (rCX) are address-sized and default to 64 bits. For 32-bit address size, any pointer and count registers are zero-extended to 64 bits.
6. The default operand size can be overridden to 16 bits with 66h prefix, but there is no 32-bit operand-size override in 64-bit mode.

Table B-1. Operations and Operands in 64-Bit Mode (continued)

Instruction and Opcode (hex)¹	Type of Operation²	Default Operand Size³	For 32-Bit Operand Size⁴	For 64-Bit Operand Size⁴
BSR —Bit Scan Reverse 0F BD	Promoted to 64 bits.	32 bits	Zero-extends 32-bit register results to 64 bits.	
BSWAP —Byte Swap 0F C8 through 0F CF	Promoted to 64 bits.	32 bits	Zero-extends 32-bit register results to 64 bits.	Swap all 8 bytes of a 64-bit GPR.
BT —Bit Test 0F A3 0F BA /4	Promoted to 64 bits.	32 bits	No GPR register results.	
BTC —Bit Test and Complement 0F BB 0F BA /7	Promoted to 64 bits.	32 bits	Zero-extends 32-bit register results to 64 bits.	
BTR —Bit Test and Reset 0F B3 0F BA /6	Promoted to 64 bits.	32 bits	Zero-extends 32-bit register results to 64 bits.	
BTS —Bit Test and Set 0F AB 0F BA /5	Promoted to 64 bits.	32 bits	Zero-extends 32-bit register results to 64 bits.	

Note:

1. See “General Rules for 64-Bit Mode” on page 405, for opcodes that do not appear in this table.
2. The type of operation, excluding considerations of operand size or extension of results. See “General Rules for 64-Bit Mode” on page 405 for definitions of “Promoted to 64 bits” and related topics.
3. If “Type of Operation” is 64 bits, a REX prefix is needed for 64-bit operand size, unless the instruction size defaults to 64 bits. If the operand size is fixed, operand-size overrides are silently ignored.
4. Special actions in 64-bit mode, in addition to legacy-mode actions. Zero or sign extensions apply only to result operands, not source operands. Unless otherwise stated, 8-bit and 16-bit results leave the high 56 or 48 bits, respectively, of 64-bit destination registers unchanged. Immediates and branch displacements are sign-extended to 64 bits.
5. Any pointer registers (rDI, rSI) or count registers (rCX) are address-sized and default to 64 bits. For 32-bit address size, any pointer and count registers are zero-extended to 64 bits.
6. The default operand size can be overridden to 16 bits with 66h prefix, but there is no 32-bit operand-size override in 64-bit mode.

Table B-1. Operations and Operands in 64-Bit Mode (continued)

Instruction and Opcode (hex) ¹	Type of Operation ²	Default Operand Size ³	For 32-Bit Operand Size ⁴	For 64-Bit Operand Size ⁴
CALL —Procedure Call Near	See “Near Branches in 64-Bit Mode” in Volume 1.			
E8	Promoted to 64 bits.	64 bits	Can't encode. ⁶	RIP = RIP + 32-bit displacement sign-extended to 64 bits.
FF /2	Promoted to 64 bits.	64 bits	Can't encode. ⁶	RIP = 64-bit offset from register or memory.
CALL —Procedure Call Far	See “Branches to 64-Bit Offsets” in Volume 1.			
9A	INVALID IN 64-BIT MODE (invalid-opcode exception)			
FF /3	Promoted to 64 bits.	32 bits	If selector points to a gate, then RIP = 64-bit offset from gate, else RIP = zero-extended 32-bit offset from far pointer referenced in instruction.	
CBW, CWDE, CDQE —Convert Byte to Word, Convert Word to Doubleword, Convert Doubleword to Quadword	Promoted to 64 bits.	32 bits (size of destination register)	CWDE: Converts word to doubleword. Zero-extends EAX to RAX.	CDQE (new mnemonic): Converts doubleword to quadword. RAX = sign-extended EAX.
CDQ	see CWD, CDQ, CQO			
CDQE (new mnemonic)	see CBW, CWDE, CDQE			
Note:				
1. See “General Rules for 64-Bit Mode” on page 405, for opcodes that do not appear in this table.				
2. The type of operation, excluding considerations of operand size or extension of results. See “General Rules for 64-Bit Mode” on page 405 for definitions of “Promoted to 64 bits” and related topics.				
3. If “Type of Operation” is 64 bits, a REX prefix is needed for 64-bit operand size, unless the instruction size defaults to 64 bits. If the operand size is fixed, operand-size overrides are silently ignored.				
4. Special actions in 64-bit mode, in addition to legacy-mode actions. Zero or sign extensions apply only to result operands, not source operands. Unless otherwise stated, 8-bit and 16-bit results leave the high 56 or 48 bits, respectively, of 64-bit destination registers unchanged. Immediates and branch displacements are sign-extended to 64 bits.				
5. Any pointer registers (rDI, rSI) or count registers (rCX) are address-sized and default to 64 bits. For 32-bit address size, any pointer and count registers are zero-extended to 64 bits.				
6. The default operand size can be overridden to 16 bits with 66h prefix, but there is no 32-bit operand-size override in 64-bit mode.				

Table B-1. Operations and Operands in 64-Bit Mode (continued)

Instruction and Opcode (hex) ¹	Type of Operation ²	Default Operand Size ³	For 32-Bit Operand Size ⁴	For 64-Bit Operand Size ⁴
CDWE	see CBW, CWDE, CDQE			
CLC —Clear Carry Flag F8	Same as legacy mode.	Not relevant.	No GPR register results.	
CLD —Clear Direction Flag FC	Same as legacy mode.	Not relevant.	No GPR register results.	
CLFLUSH —Cache Line Invalidate 0F AE /7	Same as legacy mode.	Not relevant.	No GPR register results.	
CLI —Clear Interrupt Flag FA	Same as legacy mode.	Not relevant.	No GPR register results.	
CLTS —Clear Task-Switched Flag in CR0 0F 06	Same as legacy mode.	Not relevant.	No GPR register results.	
CMC —Complement Carry Flag F5	Same as legacy mode.	Not relevant.	No GPR register results.	
CMOVcc —Conditional Move 0F 40 through 0F 4F	Promoted to 64 bits.	32 bits	Zero-extends 32-bit register results to 64 bits. This occurs even if the condition is false.	

Note:

1. See “General Rules for 64-Bit Mode” on page 405, for opcodes that do not appear in this table.
2. The type of operation, excluding considerations of operand size or extension of results. See “General Rules for 64-Bit Mode” on page 405 for definitions of “Promoted to 64 bits” and related topics.
3. If “Type of Operation” is 64 bits, a REX prefix is needed for 64-bit operand size, unless the instruction size defaults to 64 bits. If the operand size is fixed, operand-size overrides are silently ignored.
4. Special actions in 64-bit mode, in addition to legacy-mode actions. Zero or sign extensions apply only to result operands, not source operands. Unless otherwise stated, 8-bit and 16-bit results leave the high 56 or 48 bits, respectively, of 64-bit destination registers unchanged. Immediates and branch displacements are sign-extended to 64 bits.
5. Any pointer registers (rDI, rSI) or count registers (rCX) are address-sized and default to 64 bits. For 32-bit address size, any pointer and count registers are zero-extended to 64 bits.
6. The default operand size can be overridden to 16 bits with 66h prefix, but there is no 32-bit operand-size override in 64-bit mode.

Table B-1. Operations and Operands in 64-Bit Mode (continued)

Instruction and Opcode (hex)¹	Type of Operation²	Default Operand Size³	For 32-Bit Operand Size⁴	For 64-Bit Operand Size⁴
CMP —Compare 39 3B 3D 81 /7 83 /7	Promoted to 64 bits.	32 bits	Zero-extends 32-bit register results to 64 bits.	
CMPS, CMPSW, CMPSD, CMPSQ —Compare Strings A7	Promoted to 64 bits.	32 bits	CMPSD: Compare String Doublewords. See footnote ⁵	CMPSQ (new mnemonic): Compare String Quadwords See footnote ⁵
CMPXCHG —Compare and Exchange 0F B1	Promoted to 64 bits.	32 bits	Zero-extends 32-bit register results to 64 bits.	
CMPXCHG8B —Compare and Exchange Eight Bytes 0F C7 /1	Same as legacy mode.	Operand size fixed at 32 bits.	Zero-extends EDX and EAX to 64 bits.	Invalid opcode exception with 64-bit operand size.
CPUID —Processor Identification 0F A2	Same as legacy mode.	Operand size fixed at 32 bits.	Zero-extends 32-bit register results to 64 bits.	

Note:

1. See “General Rules for 64-Bit Mode” on page 405, for opcodes that do not appear in this table.
2. The type of operation, excluding considerations of operand size or extension of results. See “General Rules for 64-Bit Mode” on page 405 for definitions of “Promoted to 64 bits” and related topics.
3. If “Type of Operation” is 64 bits, a REX prefix is needed for 64-bit operand size, unless the instruction size defaults to 64 bits. If the operand size is fixed, operand-size overrides are silently ignored.
4. Special actions in 64-bit mode, in addition to legacy-mode actions. Zero or sign extensions apply only to result operands, not source operands. Unless otherwise stated, 8-bit and 16-bit results leave the high 56 or 48 bits, respectively, of 64-bit destination registers unchanged. Immediates and branch displacements are sign-extended to 64 bits.
5. Any pointer registers (rDI, rSI) or count registers (rCX) are address-sized and default to 64 bits. For 32-bit address size, any pointer and count registers are zero-extended to 64 bits.
6. The default operand size can be overridden to 16 bits with 66h prefix, but there is no 32-bit operand-size override in 64-bit mode.

Table B-1. Operations and Operands in 64-Bit Mode (continued)

Instruction and Opcode (hex) ¹	Type of Operation ²	Default Operand Size ³	For 32-Bit Operand Size ⁴	For 64-Bit Operand Size ⁴
CQO (new mnemonic)	see CWD, CDQ, CQO			
CWD, CDQ, CQO —Convert Word to Doubleword, Convert Doubleword to Quadword, Convert Quadword to Double Quadword 99	Promoted to 64 bits.	32 bits (size of destination register)	CDQ: Converts doubleword to quadword. Sign-extends EAX to EDX. Zero-extends EDX to RDX. RAX is unchanged.	CQO (new mnemonic): Converts quadword to double quadword. Sign-extends RAX to RDX. RAX is unchanged.
DAA - Decimal Adjust AL after Addition 27	INVALID IN 64-BIT MODE (invalid-opcode exception)			
DAS - Decimal Adjust AL after Subtraction 2F	INVALID IN 64-BIT MODE (invalid-opcode exception)			
DEC —Decrement by 1 FF /1 48 through 4F	Promoted to 64 bits.	32 bits	Zero-extends 32-bit register results to 64 bits.	
OPCODE USED as REX PREFIX in 64-BIT MODE				
DIV —Unsigned Divide F7 /6	Promoted to 64 bits.	32 bits	Zero-extends 32-bit register results to 64 bits.	RDX:RAX contain a 64-bit quotient (RAX) and 64-bit remainder (RDX).
ENTER —Create Procedure Stack Frame C8	Promoted to 64 bits.	64 bits	Can't encode ⁶	

Note:

1. See "General Rules for 64-Bit Mode" on page 405, for opcodes that do not appear in this table.
2. The type of operation, excluding considerations of operand size or extension of results. See "General Rules for 64-Bit Mode" on page 405 for definitions of "Promoted to 64 bits" and related topics.
3. If "Type of Operation" is 64 bits, a REX prefix is needed for 64-bit operand size, unless the instruction size defaults to 64 bits. If the operand size is fixed, operand-size overrides are silently ignored.
4. Special actions in 64-bit mode, in addition to legacy-mode actions. Zero or sign extensions apply only to result operands, not source operands. Unless otherwise stated, 8-bit and 16-bit results leave the high 56 or 48 bits, respectively, of 64-bit destination registers unchanged. immediates and branch displacements are sign-extended to 64 bits.
5. Any pointer registers (rDI, rSI) or count registers (rCX) are address-sized and default to 64 bits. For 32-bit address size, any pointer and count registers are zero-extended to 64 bits.
6. The default operand size can be overridden to 16 bits with 66h prefix, but there is no 32-bit operand-size override in 64-bit mode.

Table B-1. Operations and Operands in 64-Bit Mode (continued)

Instruction and Opcode (hex) ¹	Type of Operation ²	Default Operand Size ³	For 32-Bit Operand Size ⁴	For 64-Bit Operand Size ⁴
HLT —Halt F4	Same as legacy mode.	Not relevant.	No GPR register results.	
IDIV —Signed Divide F7 /7	Promoted to 64 bits.	32 bits	Zero-extends 32-bit register results to 64 bits.	RDX:RAX contain a 64-bit quotient (RAX) and 64-bit remainder (RDX).
IMUL - Signed Multiply F7 /5 0F AF 69 6B	Promoted to 64 bits.	32 bits	Zero-extends 32-bit register results to 64 bits.	RDX:RAX = RAX * reg/mem64 (i.e., 128-bit result) reg64 = reg64 * reg/mem64 reg64 = reg/mem64 * imm32 reg64 = reg/mem64 * imm8
IN —Input From Port E5 ED	Same as legacy mode.	32 bits	Zero-extends 32-bit register results to 64 bits.	

Note:

1. See "General Rules for 64-Bit Mode" on page 405, for opcodes that do not appear in this table.
2. The type of operation, excluding considerations of operand size or extension of results. See "General Rules for 64-Bit Mode" on page 405 for definitions of "Promoted to 64 bits" and related topics.
3. If "Type of Operation" is 64 bits, a REX prefix is needed for 64-bit operand size, unless the instruction size defaults to 64 bits. If the operand size is fixed, operand-size overrides are silently ignored.
4. Special actions in 64-bit mode, in addition to legacy-mode actions. Zero or sign extensions apply only to result operands, not source operands. Unless otherwise stated, 8-bit and 16-bit results leave the high 56 or 48 bits, respectively, of 64-bit destination registers unchanged. Immediates and branch displacements are sign-extended to 64 bits.
5. Any pointer registers (rDI, rSI) or count registers (rCX) are address-sized and default to 64 bits. For 32-bit address size, any pointer and count registers are zero-extended to 64 bits.
6. The default operand size can be overridden to 16 bits with 66h prefix, but there is no 32-bit operand-size override in 64-bit mode.

Table B-1. Operations and Operands in 64-Bit Mode (continued)

Instruction and Opcode (hex) ¹	Type of Operation ²	Default Operand Size ³	For 32-Bit Operand Size ⁴	For 64-Bit Operand Size ⁴
INC —Increment by 1 FF /0 40 through 47	Promoted to 64 bits.	32 bits	Zero-extends 32-bit register results to 64 bits.	
OPCODE USED as REX PREFIX in 64-BIT MODE				
INS, INSW, INSD —Input String 6D	Same as legacy mode.	32 bits	INSD: Input String Doublewords. No GPR register results. See footnote ⁵	
INT n —Interrupt to Vector CD	Promoted to 64 bits.	Not relevant.	See “Long-Mode Interrupt Control Transfers” in Volume 2.	
INT3 —Interrupt to Debug Vector CC				
INTO - Interrupt to Overflow Vector CE	INVALID IN 64-BIT MODE (invalid-opcode exception)			
INVD —Invalidate Internal Caches 0F 08	Same as legacy mode.	Not relevant.	No GPR register results.	
INVLPG —Invalidate TLB Entry 0F 01 /7	Promoted to 64 bits.	Not relevant.	No GPR register results.	

Note:

1. See “General Rules for 64-Bit Mode” on page 405, for opcodes that do not appear in this table.
2. The type of operation, excluding considerations of operand size or extension of results. See “General Rules for 64-Bit Mode” on page 405 for definitions of “Promoted to 64 bits” and related topics.
3. If “Type of Operation” is 64 bits, a REX prefix is needed for 64-bit operand size, unless the instruction size defaults to 64 bits. If the operand size is fixed, operand-size overrides are silently ignored.
4. Special actions in 64-bit mode, in addition to legacy-mode actions. Zero or sign extensions apply only to result operands, not source operands. Unless otherwise stated, 8-bit and 16-bit results leave the high 56 or 48 bits, respectively, of 64-bit destination registers unchanged. Immediates and branch displacements are sign-extended to 64 bits.
5. Any pointer registers (rDI, rSI) or count registers (rCX) are address-sized and default to 64 bits. For 32-bit address size, any pointer and count registers are zero-extended to 64 bits.
6. The default operand size can be overridden to 16 bits with 66h prefix, but there is no 32-bit operand-size override in 64-bit mode.

Table B-1. Operations and Operands in 64-Bit Mode (continued)

Instruction and Opcode (hex) ¹	Type of Operation ²	Default Operand Size ³	For 32-Bit Operand Size ⁴	For 64-Bit Operand Size ⁴
<p>IRET, IRETD, IRETQ—Interrupt Return</p> <p>CF</p>	<p>Promoted to 64 bits.</p>	<p>32 bits</p>	<p>IRETD: Interrupt Return Doubleword. See “Long-Mode Interrupt Control Transfers” in Volume 2.</p>	<p>IRETQ (new mnemonic): Interrupt Return Quadword. See “Long-Mode Interrupt Control Transfers” in Volume 2.</p>
<p>Jcc—Jump Conditional</p> <p>70 through 7F</p> <p>0F 80 through 0F 8F</p>	<p>Promoted to 64 bits.</p>	<p>64 bits</p>	<p>See “Near Branches in 64-Bit Mode” in Volume 1.</p> <p>Can’t encode.⁶</p>	<p>RIP = RIP + 8-bit displacement sign-extended to 64 bits.</p> <p>RIP = RIP + 32-bit displacement sign-extended to 64 bits.</p>
<p>JCXZ, JECXZ, JRCXZ—Jump on CX/ECX/RCX Zero</p> <p>E3</p>	<p>Promoted to 64 bits.</p>	<p>64 bits</p>	<p>Can’t encode.⁶</p>	<p>RIP = RIP + 8-bit displacement sign-extended to 64 bits.</p> <p>See footnote⁵</p>

Note:

1. See “General Rules for 64-Bit Mode” on page 405, for opcodes that do not appear in this table.
2. The type of operation, excluding considerations of operand size or extension of results. See “General Rules for 64-Bit Mode” on page 405 for definitions of “Promoted to 64 bits” and related topics.
3. If “Type of Operation” is 64 bits, a REX prefix is needed for 64-bit operand size, unless the instruction size defaults to 64 bits. If the operand size is fixed, operand-size overrides are silently ignored.
4. Special actions in 64-bit mode, in addition to legacy-mode actions. Zero or sign extensions apply only to result operands, not source operands. Unless otherwise stated, 8-bit and 16-bit results leave the high 56 or 48 bits, respectively, of 64-bit destination registers unchanged. Immediates and branch displacements are sign-extended to 64 bits.
5. Any pointer registers (rDI, rSI) or count registers (rCX) are address-sized and default to 64 bits. For 32-bit address size, any pointer and count registers are zero-extended to 64 bits.
6. The default operand size can be overridden to 16 bits with 66h prefix, but there is no 32-bit operand-size override in 64-bit mode.

Table B-1. Operations and Operands in 64-Bit Mode (continued)

Instruction and Opcode (hex) ¹	Type of Operation ²	Default Operand Size ³	For 32-Bit Operand Size ⁴	For 64-Bit Operand Size ⁴
JMP —Jump Near	See “Near Branches in 64-Bit Mode” in Volume 1.			
EB	Promoted to 64 bits.	64 bits	Can't encode. ⁶	RIP = RIP + 8-bit displacement sign-extended to 64 bits.
E9				RIP = RIP + 32-bit displacement sign-extended to 64 bits.
FF /4				RIP = 64-bit offset from register or memory.
JMP —Jump Far	See “Branches to 64-Bit Offsets” in Volume 1.			
EA	INVALID IN 64-BIT MODE (invalid-opcode exception)			
FF /5	Promoted to 64 bits.	32 bits	If selector points to a gate, then RIP = 64-bit offset from gate, else RIP = zero-extended 32-bit offset from far pointer referenced in instruction.	
LAHF - Load Status Flags into AH Register	Same as legacy mode.	Not relevant.		
9F				
LAR —Load Access Rights Byte	Same as legacy mode.	32 bits	Zero-extends 32-bit register results to 64 bits.	
0F 02				

Note:

- See “General Rules for 64-Bit Mode” on page 405, for opcodes that do not appear in this table.
- The type of operation, excluding considerations of operand size or extension of results. See “General Rules for 64-Bit Mode” on page 405 for definitions of “Promoted to 64 bits” and related topics.
- If “Type of Operation” is 64 bits, a REX prefix is needed for 64-bit operand size, unless the instruction size defaults to 64 bits. If the operand size is fixed, operand-size overrides are silently ignored.
- Special actions in 64-bit mode, in addition to legacy-mode actions. Zero or sign extensions apply only to result operands, not source operands. Unless otherwise stated, 8-bit and 16-bit results leave the high 56 or 48 bits, respectively, of 64-bit destination registers unchanged. Immediates and branch displacements are sign-extended to 64 bits.
- Any pointer registers (rDI, rSI) or count registers (rCX) are address-sized and default to 64 bits. For 32-bit address size, any pointer and count registers are zero-extended to 64 bits.
- The default operand size can be overridden to 16 bits with 66h prefix, but there is no 32-bit operand-size override in 64-bit mode.

Table B-1. Operations and Operands in 64-Bit Mode (continued)

Instruction and Opcode (hex) ¹	Type of Operation ²	Default Operand Size ³	For 32-Bit Operand Size ⁴	For 64-Bit Operand Size ⁴
LDS - Load DS Far Pointer C5	INVALID IN 64-BIT MODE (invalid-opcode exception)			
LEA —Load Effective Address 8D	Promoted to 64 bits.	32 bits	Zero-extends 32-bit register results to 64 bits.	
LEAVE —Delete Procedure Stack Frame C9	Promoted to 64 bits.	64 bits	Can't encode ⁶	
LES - Load ES Far Pointer C4	INVALID IN 64-BIT MODE (invalid-opcode exception)			
LFENCE —Load Fence 0F AE /5	Same as legacy mode.	Not relevant.	No GPR register results.	
LFS —Load FS Far Pointer 0F B4	Same as legacy mode.	32 bits	Zero-extends 32-bit register results to 64 bits.	
LGDT —Load Global Descriptor Table Register 0F 01 /2	Promoted to 64 bits.	Operand size fixed at 64 bits.	No GPR register results. Loads 8-byte base and 2-byte limit.	
LGS —Load GS Far Pointer 0F B5	Same as legacy mode.	32 bits	Zero-extends 32-bit register results to 64 bits.	

Note:

1. See "General Rules for 64-Bit Mode" on page 405, for opcodes that do not appear in this table.
2. The type of operation, excluding considerations of operand size or extension of results. See "General Rules for 64-Bit Mode" on page 405 for definitions of "Promoted to 64 bits" and related topics.
3. If "Type of Operation" is 64 bits, a REX prefix is needed for 64-bit operand size, unless the instruction size defaults to 64 bits. If the operand size is fixed, operand-size overrides are silently ignored.
4. Special actions in 64-bit mode, in addition to legacy-mode actions. Zero or sign extensions apply only to result operands, not source operands. Unless otherwise stated, 8-bit and 16-bit results leave the high 56 or 48 bits, respectively, of 64-bit destination registers unchanged. Immediates and branch displacements are sign-extended to 64 bits.
5. Any pointer registers (rDI, rSI) or count registers (rCX) are address-sized and default to 64 bits. For 32-bit address size, any pointer and count registers are zero-extended to 64 bits.
6. The default operand size can be overridden to 16 bits with 66h prefix, but there is no 32-bit operand-size override in 64-bit mode.

Table B-1. Operations and Operands in 64-Bit Mode (continued)

Instruction and Opcode (hex)¹	Type of Operation²	Default Operand Size³	For 32-Bit Operand Size⁴	For 64-Bit Operand Size⁴
LIDT —Load Interrupt Descriptor Table Register 0F 01 /3	Promoted to 64 bits.	Operand size fixed at 64 bits.	No GPR register results. Loads 8-byte base and 2-byte limit.	
LLDT —Load Local Descriptor Table Register 0F 00 /2	Promoted to 64 bits.	Operand size fixed at 16 bits.	No GPR register results. References 16-byte descriptor to load 64-bit base.	
LMSW —Load Machine Status Word 0F 01 /6	Same as legacy mode.	Operand size fixed at 16 bits.	No GPR register results.	
LODS, LODSW, LODSD, LODSQ —Load String AD	Promoted to 64 bits.	32 bits	LODSD: Load String Doublewords. Zero-extends 32-bit register results to 64 bits. See footnote ⁵	LODSQ (new mnemonic): Load String Quadwords. See footnote ⁵
LOOP —Loop E2	Promoted to 64 bits.	64 bits	Can't encode. ⁶	RIP = RIP + 8-bit displacement sign-extended to 64 bits. See footnote ⁵
LOOPZ, LOOPE —Loop if Zero/Equal E1				
LOOPNZ, LOOPNE —Loop if Not Zero/Equal E0				
Note:				
1. See "General Rules for 64-Bit Mode" on page 405, for opcodes that do not appear in this table.				
2. The type of operation, excluding considerations of operand size or extension of results. See "General Rules for 64-Bit Mode" on page 405 for definitions of "Promoted to 64 bits" and related topics.				
3. If "Type of Operation" is 64 bits, a REX prefix is needed for 64-bit operand size, unless the instruction size defaults to 64 bits. If the operand size is fixed, operand-size overrides are silently ignored.				
4. Special actions in 64-bit mode, in addition to legacy-mode actions. Zero or sign extensions apply only to result operands, not source operands. Unless otherwise stated, 8-bit and 16-bit results leave the high 56 or 48 bits, respectively, of 64-bit destination registers unchanged. Immediates and branch displacements are sign-extended to 64 bits.				
5. Any pointer registers (rDI, rSI) or count registers (rCX) are address-sized and default to 64 bits. For 32-bit address size, any pointer and count registers are zero-extended to 64 bits.				
6. The default operand size can be overridden to 16 bits with 66h prefix, but there is no 32-bit operand-size override in 64-bit mode.				

Table B-1. Operations and Operands in 64-Bit Mode (continued)

Instruction and Opcode (hex)¹	Type of Operation²	Default Operand Size³	For 32-Bit Operand Size⁴	For 64-Bit Operand Size⁴
LSL —Load Segment Limit 0F 03	Same as legacy mode.	32 bits	Zero-extends 32-bit register results to 64 bits.	
LSS —Load SS Segment Register 0F B2	Same as legacy mode.	32 bits	Zero-extends 32-bit register results to 64 bits.	
LTR —Load Task Register 0F 00 /3	Promoted to 64 bits.	Operand size fixed at 16 bits.	No GPR register results. References 16-byte descriptor to load 64-bit base.	
MFENCE —Memory Fence 0F AE /6	Same as legacy mode.	Not relevant.	No GPR register results.	

Note:

1. See "General Rules for 64-Bit Mode" on page 405, for opcodes that do not appear in this table.
2. The type of operation, excluding considerations of operand size or extension of results. See "General Rules for 64-Bit Mode" on page 405 for definitions of "Promoted to 64 bits" and related topics.
3. If "Type of Operation" is 64 bits, a REX prefix is needed for 64-bit operand size, unless the instruction size defaults to 64 bits. If the operand size is fixed, operand-size overrides are silently ignored.
4. Special actions in 64-bit mode, in addition to legacy-mode actions. Zero or sign extensions apply only to result operands, not source operands. Unless otherwise stated, 8-bit and 16-bit results leave the high 56 or 48 bits, respectively, of 64-bit destination registers unchanged. immediates and branch displacements are sign-extended to 64 bits.
5. Any pointer registers (rDI, rSI) or count registers (rCX) are address-sized and default to 64 bits. For 32-bit address size, any pointer and count registers are zero-extended to 64 bits.
6. The default operand size can be overridden to 16 bits with 66h prefix, but there is no 32-bit operand-size override in 64-bit mode.

Table B-1. Operations and Operands in 64-Bit Mode (continued)

Instruction and Opcode (hex) ¹	Type of Operation ²	Default Operand Size ³	For 32-Bit Operand Size ⁴	For 64-Bit Operand Size ⁴
MOV —Move 89 8B C7 B8 through BF A1 (moffset) A3 (moffset)	Promoted to 64 bits.	32 bits	Zero-extends 32-bit register results to 64 bits. Zero-extends 32-bit register results to 64 bits. Memory offsets are address-sized and default to 64 bits.	32-bit immediate is sign-extended to 64 bits. 64-bit immediate. Memory offsets are address-sized and default to 64 bits.
MOV —Move to/from Segment Registers 8C 8E	Same as legacy mode.	32 bits Operand size fixed at 16 bits.	Zero-extends 32-bit register results to 64 bits. No GPR register results.	
MOV(CR<i>n</i>) —Move to/from Control Registers 0F 22 0F 20	Promoted to 64 bits.	Operand size fixed at 64 bits.	The high 32 bits of control registers differ in their writability and reserved status. See “System Resources” in Volume 2 for details.	
Note:				
<ol style="list-style-type: none"> See “General Rules for 64-Bit Mode” on page 405, for opcodes that do not appear in this table. The type of operation, excluding considerations of operand size or extension of results. See “General Rules for 64-Bit Mode” on page 405 for definitions of “Promoted to 64 bits” and related topics. If “Type of Operation” is 64 bits, a REX prefix is needed for 64-bit operand size, unless the instruction size defaults to 64 bits. If the operand size is fixed, operand-size overrides are silently ignored. Special actions in 64-bit mode, in addition to legacy-mode actions. Zero or sign extensions apply only to result operands, not source operands. Unless otherwise stated, 8-bit and 16-bit results leave the high 56 or 48 bits, respectively, of 64-bit destination registers unchanged. Immediates and branch displacements are sign-extended to 64 bits. Any pointer registers (rDI, rSI) or count registers (rCX) are address-sized and default to 64 bits. For 32-bit address size, any pointer and count registers are zero-extended to 64 bits. The default operand size can be overridden to 16 bits with 66h prefix, but there is no 32-bit operand-size override in 64-bit mode. 				

Table B-1. Operations and Operands in 64-Bit Mode (continued)

Instruction and Opcode (hex) ¹	Type of Operation ²	Default Operand Size ³	For 32-Bit Operand Size ⁴	For 64-Bit Operand Size ⁴
MOV(DRn) —Move to/from Debug Registers 0F 21 0F 23	Promoted to 64 bits.	Operand size fixed at 64 bits.	The high 32 bits of debug registers differ in their writability and reserved status. See “Debug and Performance Resources” in Volume 2 for details.	
MOVD —Move Doubleword or Quadword 0F 6E 0F 7E 66 0F 6E 66 0F 7E	Promoted to 64 bits.	32 bits	Zero-extends 32-bit register results to 64 bits.	
			Zero-extends 32-bit register results to 128 bits.	Zero-extends 64-bit register results to 128 bits.
MOVNTI —Move Non-Temporal Doubleword 0F C3	Promoted to 64 bits.	32 bits	No GPR register results.	
MOVS, MOVSW, MOVSD, MOVSQ —Move String A5	Promoted to 64 bits.	32 bits	MOVSD: Move String Doublewords. See footnote ⁵	MOVSQ (new mnemonic): Move String Quadwords. See footnote ⁵

Note:

1. See “General Rules for 64-Bit Mode” on page 405, for opcodes that do not appear in this table.
2. The type of operation, excluding considerations of operand size or extension of results. See “General Rules for 64-Bit Mode” on page 405 for definitions of “Promoted to 64 bits” and related topics.
3. If “Type of Operation” is 64 bits, a REX prefix is needed for 64-bit operand size, unless the instruction size defaults to 64 bits. If the operand size is fixed, operand-size overrides are silently ignored.
4. Special actions in 64-bit mode, in addition to legacy-mode actions. Zero or sign extensions apply only to result operands, not source operands. Unless otherwise stated, 8-bit and 16-bit results leave the high 56 or 48 bits, respectively, of 64-bit destination registers unchanged. immediates and branch displacements are sign-extended to 64 bits.
5. Any pointer registers (rDI, rSI) or count registers (rCX) are address-sized and default to 64 bits. For 32-bit address size, any pointer and count registers are zero-extended to 64 bits.
6. The default operand size can be overridden to 16 bits with 66h prefix, but there is no 32-bit operand-size override in 64-bit mode.

Table B-1. Operations and Operands in 64-Bit Mode (continued)

Instruction and Opcode (hex) ¹	Type of Operation ²	Default Operand Size ³	For 32-Bit Operand Size ⁴	For 64-Bit Operand Size ⁴
MOVSX —Move with Sign-Extend	Promoted to 64 bits.	32 bits	Zero-extends 32-bit register results to 64 bits.	Sign-extends byte to quadword.
0F BE				Sign-extends word to quadword.
0F BF				
MOVSXD —Move with Sign-Extend Doubleword	New instruction, available only in 64-bit mode. (In other modes, this opcode is ARPL instruction.)	32 bits	Zero-extends 32-bit register results to 64 bits.	Sign-extends doubleword to quadword.
63				
MOVZX —Move with Zero-Extend	Promoted to 64 bits.	32 bits	Zero-extends 32-bit register results to 64 bits.	Zero-extends byte to quadword.
0F B6				Zero-extends word to quadword.
0F B7				
MUL —Multiply Unsigned	Promoted to 64 bits.	32 bits	Zero-extends 32-bit register results to 64 bits.	RDX:RAX=RAX * quadword in register or memory.
F7 /4				

Note:

1. See “General Rules for 64-Bit Mode” on page 405, for opcodes that do not appear in this table.
2. The type of operation, excluding considerations of operand size or extension of results. See “General Rules for 64-Bit Mode” on page 405 for definitions of “Promoted to 64 bits” and related topics.
3. If “Type of Operation” is 64 bits, a REX prefix is needed for 64-bit operand size, unless the instruction size defaults to 64 bits. If the operand size is fixed, operand-size overrides are silently ignored.
4. Special actions in 64-bit mode, in addition to legacy-mode actions. Zero or sign extensions apply only to result operands, not source operands. Unless otherwise stated, 8-bit and 16-bit results leave the high 56 or 48 bits, respectively, of 64-bit destination registers unchanged. Immediates and branch displacements are sign-extended to 64 bits.
5. Any pointer registers (rDI, rSI) or count registers (rCX) are address-sized and default to 64 bits. For 32-bit address size, any pointer and count registers are zero-extended to 64 bits.
6. The default operand size can be overridden to 16 bits with 66h prefix, but there is no 32-bit operand-size override in 64-bit mode.

Table B-1. Operations and Operands in 64-Bit Mode (continued)

Instruction and Opcode (hex)¹	Type of Operation²	Default Operand Size³	For 32-Bit Operand Size⁴	For 64-Bit Operand Size⁴
NEG —Negate Two’s Complement F7 /3	Promoted to 64 bits.	32 bits	Zero-extends 32-bit register results to 64 bits.	
NOP —No Operation 90	Same as legacy mode.	Not relevant.	No GPR register results.	
NOT —Negate One’s Complement F7 /2	Promoted to 64 bits.	32 bits	Zero-extends 32-bit register results to 64 bits.	
OR —Logical OR 09 0B 0D 81 /1 83 /1	Promoted to 64 bits.	32 bits	Zero-extends 32-bit register results to 64 bits.	
OUT —Output to Port E7 EF	Same as legacy mode.	32 bits	No GPR register results.	
OUTS, OUTSW, OUTSD —Output String 6F	Same as legacy mode.	32 bits	Writes doubleword to I/O port. No GPR register results. See footnote ⁵	

Note:

1. See “General Rules for 64-Bit Mode” on page 405, for opcodes that do not appear in this table.
2. The type of operation, excluding considerations of operand size or extension of results. See “General Rules for 64-Bit Mode” on page 405 for definitions of “Promoted to 64 bits” and related topics.
3. If “Type of Operation” is 64 bits, a REX prefix is needed for 64-bit operand size, unless the instruction size defaults to 64 bits. If the operand size is fixed, operand-size overrides are silently ignored.
4. Special actions in 64-bit mode, in addition to legacy-mode actions. Zero or sign extensions apply only to result operands, not source operands. Unless otherwise stated, 8-bit and 16-bit results leave the high 56 or 48 bits, respectively, of 64-bit destination registers unchanged. immediates and branch displacements are sign-extended to 64 bits.
5. Any pointer registers (rDI, rSI) or count registers (rCX) are address-sized and default to 64 bits. For 32-bit address size, any pointer and count registers are zero-extended to 64 bits.
6. The default operand size can be overridden to 16 bits with 66h prefix, but there is no 32-bit operand-size override in 64-bit mode.

Table B-1. Operations and Operands in 64-Bit Mode (continued)

Instruction and Opcode (hex)¹	Type of Operation²	Default Operand Size³	For 32-Bit Operand Size⁴	For 64-Bit Operand Size⁴
POP —Pop Stack 8F /0 58 through 5F	Promoted to 64 bits.	64 bits	Cannot encode ⁶	No GPR register results.
POP —Pop (segment register from) Stack 0F A1 (POP FS) 0F A9 (POP GS) 1F (POP DS) 07 (POP ES) 17 (POP SS)	Same as legacy mode.	64 bits	Cannot encode ⁶	No GPR register results.
POPA, POPAD - Pop All to GPR Words or Doublewords 61	INVALID IN 64-BIT MODE (invalid-opcode exception)			
POPF, POPFD, POPFQ —Pop to rFLAGS Word, Doubleword, or Quadword 9D	Promoted to 64 bits.	64 bits	Cannot encode ⁶	POPFQ (new mnemonic): Pops 64 bits off stack, writes low 32 bits into EFLAGS and zero-extends the high 32 bits of RFLAGS.
PREFETCH —Prefetch L1 Data-Cache Line 0F 0D /0	Same as legacy mode.	Not relevant.	No GPR register results.	
Note:				
1. See “General Rules for 64-Bit Mode” on page 405, for opcodes that do not appear in this table.				
2. The type of operation, excluding considerations of operand size or extension of results. See “General Rules for 64-Bit Mode” on page 405 for definitions of “Promoted to 64 bits” and related topics.				
3. If “Type of Operation” is 64 bits, a REX prefix is needed for 64-bit operand size, unless the instruction size defaults to 64 bits. If the operand size is fixed, operand-size overrides are silently ignored.				
4. Special actions in 64-bit mode, in addition to legacy-mode actions. Zero or sign extensions apply only to result operands, not source operands. Unless otherwise stated, 8-bit and 16-bit results leave the high 56 or 48 bits, respectively, of 64-bit destination registers unchanged. immediates and branch displacements are sign-extended to 64 bits.				
5. Any pointer registers (rDI, rSI) or count registers (rCX) are address-sized and default to 64 bits. For 32-bit address size, any pointer and count registers are zero-extended to 64 bits.				
6. The default operand size can be overridden to 16 bits with 66h prefix, but there is no 32-bit operand-size override in 64-bit mode.				

Table B-1. Operations and Operands in 64-Bit Mode (continued)

Instruction and Opcode (hex) ¹	Type of Operation ²	Default Operand Size ³	For 32-Bit Operand Size ⁴	For 64-Bit Operand Size ⁴
PREFETCH <i>level</i> —Prefetch Data to Cache Level <i>level</i> 0F 18 /0-3	Same as legacy mode.	Not relevant.	No GPR register results.	
PREFETCHW —Prefetch L1 Data-Cache Line for Write 0F 0D /1	Same as legacy mode.	Not relevant.	No GPR register results.	
PUSH —Push onto Stack FF /6 50 through 57 6A 68	Promoted to 64 bits.	64 bits	Cannot encode ⁶	
PUSH —Push (segment register) onto Stack 0F A0 (PUSH FS) 0F A8 (PUSH GS) 0E (PUSH CS) 1E (PUSH DS) 06 (PUSH ES) 16 (PUSH SS)	Promoted to 64 bits.	64 bits	Cannot encode ⁶	
	INVALID IN 64-BIT MODE (invalid-opcode exception)			

Note:

1. See "General Rules for 64-Bit Mode" on page 405, for opcodes that do not appear in this table.
2. The type of operation, excluding considerations of operand size or extension of results. See "General Rules for 64-Bit Mode" on page 405 for definitions of "Promoted to 64 bits" and related topics.
3. If "Type of Operation" is 64 bits, a REX prefix is needed for 64-bit operand size, unless the instruction size defaults to 64 bits. If the operand size is fixed, operand-size overrides are silently ignored.
4. Special actions in 64-bit mode, in addition to legacy-mode actions. Zero or sign extensions apply only to result operands, not source operands. Unless otherwise stated, 8-bit and 16-bit results leave the high 56 or 48 bits, respectively, of 64-bit destination registers unchanged. Immediates and branch displacements are sign-extended to 64 bits.
5. Any pointer registers (rDI, rSI) or count registers (rCX) are address-sized and default to 64 bits. For 32-bit address size, any pointer and count registers are zero-extended to 64 bits.
6. The default operand size can be overridden to 16 bits with 66h prefix, but there is no 32-bit operand-size override in 64-bit mode.

Table B-1. Operations and Operands in 64-Bit Mode (continued)

Instruction and Opcode (hex) ¹	Type of Operation ²	Default Operand Size ³	For 32-Bit Operand Size ⁴	For 64-Bit Operand Size ⁴
PUSHA, PUSHAD - Push All to GPR Words or Doublewords 60	INVALID IN 64-BIT MODE (invalid-opcode exception)			
PUSHF, PUSHFD, PUSHFQ —Push rFLAGS Word, Doubleword, or Quadword onto Stack 9C	Promoted to 64 bits.	64 bits	Cannot encode ⁶	PUSHFQ (new mnemonic): Pushes the 64-bit RFLAGS register.
RCL —Rotate Through Carry Left D1 /2 D3 /2 C1 /2	Promoted to 64 bits.	32 bits	Zero-extends 32-bit register results to 64 bits.	Uses 6-bit count.
RCR —Rotate Through Carry Right D1 /3 D3 /3 C1 /3	Promoted to 64 bits.	32 bits	Zero-extends 32-bit register results to 64 bits.	Uses 6-bit count.
RDMSR —Read Model-Specific Register 0F 32	Same as legacy mode.	Not relevant.	RDX[31:0] contains MSR[63:32], RAX[31:0] contains MSR[31:0]. Zero-extends 32-bit register results to 64 bits.	

Note:

1. See "General Rules for 64-Bit Mode" on page 405, for opcodes that do not appear in this table.
2. The type of operation, excluding considerations of operand size or extension of results. See "General Rules for 64-Bit Mode" on page 405 for definitions of "Promoted to 64 bits" and related topics.
3. If "Type of Operation" is 64 bits, a REX prefix is needed for 64-bit operand size, unless the instruction size defaults to 64 bits. If the operand size is fixed, operand-size overrides are silently ignored.
4. Special actions in 64-bit mode, in addition to legacy-mode actions. Zero or sign extensions apply only to result operands, not source operands. Unless otherwise stated, 8-bit and 16-bit results leave the high 56 or 48 bits, respectively, of 64-bit destination registers unchanged. immediates and branch displacements are sign-extended to 64 bits.
5. Any pointer registers (rDI, rSI) or count registers (rCX) are address-sized and default to 64 bits. For 32-bit address size, any pointer and count registers are zero-extended to 64 bits.
6. The default operand size can be overridden to 16 bits with 66h prefix, but there is no 32-bit operand-size override in 64-bit mode.

Table B-1. Operations and Operands in 64-Bit Mode (continued)

Instruction and Opcode (hex)¹	Type of Operation²	Default Operand Size³	For 32-Bit Operand Size⁴	For 64-Bit Operand Size⁴
RDPMC —Read Performance-Monitoring Counters 0F 33	Same as legacy mode.	Not relevant.	RDX[31:0] contains PMC[63:32], RAX[31:0] contains PMC[31:0]. Zero-extends 32-bit register results to 64 bits.	
RDTSC —Read Time-Stamp Counter 0F 31	Same as legacy mode.	Not relevant.	RDX[31:0] contains TSC[63:32], RAX[31:0] contains TSC[31:0]. Zero-extends 32-bit register results to 64 bits.	
REP INS —Repeat Input String F3 6D	Same as legacy mode.	32 bits	Reads doubleword I/O port. See footnote ⁵	
REP LODS —Repeat Load String F3 AD	Promoted to 64 bits.	32 bits	Zero-extends EAX to 64 bits. See footnote ⁵	See footnote ⁵
REP MOVS —Repeat Move String F3 A5	Promoted to 64 bits.	32 bits	No GPR register results. See footnote ⁵	
REP OUTS —Repeat Output String to Port F3 6F	Same as legacy mode.	32 bits	Writes doubleword to I/O port. No GPR register results. See footnote ⁵	
REP STOS —Repeat Store String F3 AB	Promoted to 64 bits.	32 bits	No GPR register results. See footnote ⁵	
REP_x CMPS —Repeat Compare String F3 A7	Promoted to 64 bits.	32 bits	No GPR register results. See footnote ⁵	

Note:

1. See "General Rules for 64-Bit Mode" on page 405, for opcodes that do not appear in this table.
2. The type of operation, excluding considerations of operand size or extension of results. See "General Rules for 64-Bit Mode" on page 405 for definitions of "Promoted to 64 bits" and related topics.
3. If "Type of Operation" is 64 bits, a REX prefix is needed for 64-bit operand size, unless the instruction size defaults to 64 bits. If the operand size is fixed, operand-size overrides are silently ignored.
4. Special actions in 64-bit mode, in addition to legacy-mode actions. Zero or sign extensions apply only to result operands, not source operands. Unless otherwise stated, 8-bit and 16-bit results leave the high 56 or 48 bits, respectively, of 64-bit destination registers unchanged. Immediates and branch displacements are sign-extended to 64 bits.
5. Any pointer registers (rDI, rSI) or count registers (rCX) are address-sized and default to 64 bits. For 32-bit address size, any pointer and count registers are zero-extended to 64 bits.
6. The default operand size can be overridden to 16 bits with 66h prefix, but there is no 32-bit operand-size override in 64-bit mode.

Table B-1. Operations and Operands in 64-Bit Mode (continued)

Instruction and Opcode (hex)¹	Type of Operation²	Default Operand Size³	For 32-Bit Operand Size⁴	For 64-Bit Operand Size⁴
REPx SCAS –Repeat Scan String F3 AF	Promoted to 64 bits.	32 bits	No GPR register results. See footnote ⁵	
RET –Return from Call Near C2 C3	See “Near Branches in 64-Bit Mode” in Volume 1.			
	Promoted to 64 bits.	64 bits	Cannot encode. ⁶	No GPR register results.
RET –Return from Call Far CB CA	Promoted to 64 bits.	32 bits	See “Control Transfers” in Volume 1 and “Control-Transfer Privilege Checks” in Volume 2.	
ROL –Rotate Left D1 /0 D3 /0 C1 /0	Promoted to 64 bits.	32 bits	Zero-extends 32-bit register results to 64 bits.	Uses 6-bit count.
ROR –Rotate Right D1 /1 D3 /1 C1 /1	Promoted to 64 bits.	32 bits	Zero-extends 32-bit register results to 64 bits.	Uses 6-bit count.
RSM –Resume from System Management Mode 0F AA	New SMM state-save area.	Not relevant.	See “System-Management Mode” in Volume 2.	

Note:

1. See “General Rules for 64-Bit Mode” on page 405, for opcodes that do not appear in this table.
2. The type of operation, excluding considerations of operand size or extension of results. See “General Rules for 64-Bit Mode” on page 405 for definitions of “Promoted to 64 bits” and related topics.
3. If “Type of Operation” is 64 bits, a REX prefix is needed for 64-bit operand size, unless the instruction size defaults to 64 bits. If the operand size is fixed, operand-size overrides are silently ignored.
4. Special actions in 64-bit mode, in addition to legacy-mode actions. Zero or sign extensions apply only to result operands, not source operands. Unless otherwise stated, 8-bit and 16-bit results leave the high 56 or 48 bits, respectively, of 64-bit destination registers unchanged. Immediates and branch displacements are sign-extended to 64 bits.
5. Any pointer registers (rDI, rSI) or count registers (rCX) are address-sized and default to 64 bits. For 32-bit address size, any pointer and count registers are zero-extended to 64 bits.
6. The default operand size can be overridden to 16 bits with 66h prefix, but there is no 32-bit operand-size override in 64-bit mode.

Table B-1. Operations and Operands in 64-Bit Mode (continued)

Instruction and Opcode (hex)¹	Type of Operation²	Default Operand Size³	For 32-Bit Operand Size⁴	For 64-Bit Operand Size⁴
SAHF - Store AH into Flags 9E	Same as legacy mode.	Not relevant.	No GPR register results.	
SAL —Shift Arithmetic Left D1 /4 D3 /4 C1 /4	Promoted to 64 bits.	32 bits	Zero-extends 32-bit register results to 64 bits.	Uses 6-bit count.
SAR —Shift Arithmetic Right D1 /7 D3 /7 C1 /7	Promoted to 64 bits.	32 bits	Zero-extends 32-bit register results to 64 bits.	Uses 6-bit count.
SBB —Subtract with Borrow 19 1B 1D 81 /3 83 /3	Promoted to 64 bits.	32 bits	Zero-extends 32-bit register results to 64 bits.	

Note:

1. See "General Rules for 64-Bit Mode" on page 405, for opcodes that do not appear in this table.
2. The type of operation, excluding considerations of operand size or extension of results. See "General Rules for 64-Bit Mode" on page 405 for definitions of "Promoted to 64 bits" and related topics.
3. If "Type of Operation" is 64 bits, a REX prefix is needed for 64-bit operand size, unless the instruction size defaults to 64 bits. If the operand size is fixed, operand-size overrides are silently ignored.
4. Special actions in 64-bit mode, in addition to legacy-mode actions. Zero or sign extensions apply only to result operands, not source operands. Unless otherwise stated, 8-bit and 16-bit results leave the high 56 or 48 bits, respectively, of 64-bit destination registers unchanged. Immediates and branch displacements are sign-extended to 64 bits.
5. Any pointer registers (rDI, rSI) or count registers (rCX) are address-sized and default to 64 bits. For 32-bit address size, any pointer and count registers are zero-extended to 64 bits.
6. The default operand size can be overridden to 16 bits with 66h prefix, but there is no 32-bit operand-size override in 64-bit mode.

Table B-1. Operations and Operands in 64-Bit Mode (continued)

Instruction and Opcode (hex) ¹	Type of Operation ²	Default Operand Size ³	For 32-Bit Operand Size ⁴	For 64-Bit Operand Size ⁴
SCAS, SCASW, SCASD, SCASQ —Scan String AF	Promoted to 64 bits.	32 bits	SCASD: Scan String Doublewords. Zero-extends 32-bit register results to 64 bits. See footnote ⁵	SCASQ (new mnemonic): Scan String Quadwords. See footnote ⁵
SFENCE —Store Fence 0F AE /7	Same as legacy mode.	Not relevant.	No GPR register results.	
SGDT —Store Global Descriptor Table Register 0F 01 /0	Promoted to 64 bits.	Operand size fixed at 64 bits.	No GPR register results. Stores 8-byte base and 2-byte limit.	
SHL —Shift Left D1 /4 D3 /4 C1 /4	Promoted to 64 bits.	32 bits	Zero-extends 32-bit register results to 64 bits.	Uses 6-bit count.
SHLD —Shift Left Double 0F A4 0F A5	Promoted to 64 bits.	32 bits	Zero-extends 32-bit register results to 64 bits.	Uses 6-bit count.
Note:				
<ol style="list-style-type: none"> See “General Rules for 64-Bit Mode” on page 405, for opcodes that do not appear in this table. The type of operation, excluding considerations of operand size or extension of results. See “General Rules for 64-Bit Mode” on page 405 for definitions of “Promoted to 64 bits” and related topics. If “Type of Operation” is 64 bits, a REX prefix is needed for 64-bit operand size, unless the instruction size defaults to 64 bits. If the operand size is fixed, operand-size overrides are silently ignored. Special actions in 64-bit mode, in addition to legacy-mode actions. Zero or sign extensions apply only to result operands, not source operands. Unless otherwise stated, 8-bit and 16-bit results leave the high 56 or 48 bits, respectively, of 64-bit destination registers unchanged. Immediates and branch displacements are sign-extended to 64 bits. Any pointer registers (rDI, rSI) or count registers (rCX) are address-sized and default to 64 bits. For 32-bit address size, any pointer and count registers are zero-extended to 64 bits. The default operand size can be overridden to 16 bits with 66h prefix, but there is no 32-bit operand-size override in 64-bit mode. 				

Table B-1. Operations and Operands in 64-Bit Mode (continued)

Instruction and Opcode (hex)¹	Type of Operation²	Default Operand Size³	For 32-Bit Operand Size⁴	For 64-Bit Operand Size⁴
SHR —Shift Right D1 /5 D3 /5 C1 /5	Promoted to 64 bits.	32 bits	Zero-extends 32-bit register results to 64 bits.	Uses 6-bit count.
SHRD —Shift Right Double 0F AC 0F AD	Promoted to 64 bits.	32 bits	Zero-extends 32-bit register results to 64 bits.	Uses 6-bit count.
SIDT —Store Interrupt Descriptor Table Register 0F 01 /1	Promoted to 64 bits.	Operand size fixed at 64 bits.	No GPR register results. Stores 8-byte base and 2-byte limit.	
SLDT —Store Local Descriptor Table Register 0F 00 /0	Same as legacy mode.	32	Zero-extends 2-byte LDT selector to 64 bits.	
SMSW —Store Machine Status Word 0F 01 /4	Same as legacy mode.	32	Zero-extends 32-bit register results to 64 bits.	Stores 64-bit machine status word (CR0).
STC —Set Carry Flag F9	Same as legacy mode.	Not relevant.	No GPR register results.	
STD —Set Direction Flag FD	Same as legacy mode.	Not relevant.	No GPR register results.	

Note:

1. See "General Rules for 64-Bit Mode" on page 405, for opcodes that do not appear in this table.
2. The type of operation, excluding considerations of operand size or extension of results. See "General Rules for 64-Bit Mode" on page 405 for definitions of "Promoted to 64 bits" and related topics.
3. If "Type of Operation" is 64 bits, a REX prefix is needed for 64-bit operand size, unless the instruction size defaults to 64 bits. If the operand size is fixed, operand-size overrides are silently ignored.
4. Special actions in 64-bit mode, in addition to legacy-mode actions. Zero or sign extensions apply only to result operands, not source operands. Unless otherwise stated, 8-bit and 16-bit results leave the high 56 or 48 bits, respectively, of 64-bit destination registers unchanged. Immediates and branch displacements are sign-extended to 64 bits.
5. Any pointer registers (rDI, rSI) or count registers (rCX) are address-sized and default to 64 bits. For 32-bit address size, any pointer and count registers are zero-extended to 64 bits.
6. The default operand size can be overridden to 16 bits with 66h prefix, but there is no 32-bit operand-size override in 64-bit mode.

Table B-1. Operations and Operands in 64-Bit Mode (continued)

Instruction and Opcode (hex)¹	Type of Operation²	Default Operand Size³	For 32-Bit Operand Size⁴	For 64-Bit Operand Size⁴
STI - Set Interrupt Flag FB	Same as legacy mode.	Not relevant.	No GPR register results.	
STOS, STOSW, STOSD, STOSQ - Store String AB	Promoted to 64 bits.	32 bits	STOSD: Store String Doublewords. See footnote ⁵	STOSQ (new mnemonic): Store String Quadwords. See footnote ⁵
STR —Store Task Register 0F 00 /1	Same as legacy mode.	32	Zero-extends 2-byte TR selector to 64 bits.	
SUB —Subtract 29 2B 2D 81 /5 83 /5	Promoted to 64 bits.	32 bits	Zero-extends 32-bit register results to 64 bits.	
SWAPGS —Swap GS Register with KernelGSbase MSR 0F 01 /7	New instruction, available only in 64-bit mode. (In other modes, this opcode is invalid.)	Not relevant.	See “SWAPGS Instruction” in Volume 2.	

Note:

1. See “General Rules for 64-Bit Mode” on page 405, for opcodes that do not appear in this table.
2. The type of operation, excluding considerations of operand size or extension of results. See “General Rules for 64-Bit Mode” on page 405 for definitions of “Promoted to 64 bits” and related topics.
3. If “Type of Operation” is 64 bits, a REX prefix is needed for 64-bit operand size, unless the instruction size defaults to 64 bits. If the operand size is fixed, operand-size overrides are silently ignored.
4. Special actions in 64-bit mode, in addition to legacy-mode actions. Zero or sign extensions apply only to result operands, not source operands. Unless otherwise stated, 8-bit and 16-bit results leave the high 56 or 48 bits, respectively, of 64-bit destination registers unchanged. Immediates and branch displacements are sign-extended to 64 bits.
5. Any pointer registers (rDI, rSI) or count registers (rCX) are address-sized and default to 64 bits. For 32-bit address size, any pointer and count registers are zero-extended to 64 bits.
6. The default operand size can be overridden to 16 bits with 66h prefix, but there is no 32-bit operand-size override in 64-bit mode.

Table B-1. Operations and Operands in 64-Bit Mode (continued)

Instruction and Opcode (hex)¹	Type of Operation²	Default Operand Size³	For 32-Bit Operand Size⁴	For 64-Bit Operand Size⁴
SYSCALL —Fast System Call 0F 05	Promoted to 64 bits.	Not relevant.	See “SYSCALL and SYSRET Instructions” in Volume 2 for details.	
SYSENTER —System Call 0F 34	INVALID IN LONG MODE (invalid-opcode exception)			
SYSEXIT —System Return 0F 35	INVALID IN LONG MODE (invalid-opcode exception)			
SYSRET —Fast System Return 0F 07	Promoted to 64 bits.	32 bits	See “SYSCALL and SYSRET Instructions” in Volume 2 for details.	
TEST —Test Bits 85 A9 F7 /0	Promoted to 64 bits.	32 bits	No GPR register results.	
UD2 —Undefined Operation 0F 0B	Same as legacy mode.	Not relevant.	No GPR register results.	
VERR —Verify Segment for Reads 0F 00 /4	Same as legacy mode.	Operand size fixed at 16 bits	No GPR register results.	
VERW —Verify Segment for Writes 0F 00 /5	Same as legacy mode.	Operand size fixed at 16 bits	No GPR register results.	

Note:

1. See “General Rules for 64-Bit Mode” on page 405, for opcodes that do not appear in this table.
2. The type of operation, excluding considerations of operand size or extension of results. See “General Rules for 64-Bit Mode” on page 405 for definitions of “Promoted to 64 bits” and related topics.
3. If “Type of Operation” is 64 bits, a REX prefix is needed for 64-bit operand size, unless the instruction size defaults to 64 bits. If the operand size is fixed, operand-size overrides are silently ignored.
4. Special actions in 64-bit mode, in addition to legacy-mode actions. Zero or sign extensions apply only to result operands, not source operands. Unless otherwise stated, 8-bit and 16-bit results leave the high 56 or 48 bits, respectively, of 64-bit destination registers unchanged. Immediates and branch displacements are sign-extended to 64 bits.
5. Any pointer registers (rDI, rSI) or count registers (rCX) are address-sized and default to 64 bits. For 32-bit address size, any pointer and count registers are zero-extended to 64 bits.
6. The default operand size can be overridden to 16 bits with 66h prefix, but there is no 32-bit operand-size override in 64-bit mode.

Table B-1. Operations and Operands in 64-Bit Mode (continued)

Instruction and Opcode (hex)¹	Type of Operation²	Default Operand Size³	For 32-Bit Operand Size⁴	For 64-Bit Operand Size⁴
WAIT —Wait for Interrupt 9B	Same as legacy mode.	Not relevant.	No GPR register results.	
WBINVD —Writeback and Invalidate All Caches 0F 09	Same as legacy mode.	Not relevant.	No GPR register results.	
WRMSR —Write to Model-Specific Register 0F 30	Same as legacy mode.	Not relevant.	No GPR register results. MSR[63:32] = RDX[31:0] MSR[31:0] = RAX[31:0]	
XADD —Exchange and Add 0F C1	Promoted to 64 bits.	32 bits	Zero-extends 32-bit register results to 64 bits.	
XCHG —Exchange Register/Memory with Register 87 90	Promoted to 64 bits.	32 bits	Zero-extends 32-bit register results to 64 bits.	
XOR —Logical Exclusive OR 31 33 35 81 /6 83 /6	Promoted to 64 bits.	32 bits	Zero-extends 32-bit register results to 64 bits.	

Note:

1. See “General Rules for 64-Bit Mode” on page 405, for opcodes that do not appear in this table.
2. The type of operation, excluding considerations of operand size or extension of results. See “General Rules for 64-Bit Mode” on page 405 for definitions of “Promoted to 64 bits” and related topics.
3. If “Type of Operation” is 64 bits, a REX prefix is needed for 64-bit operand size, unless the instruction size defaults to 64 bits. If the operand size is fixed, operand-size overrides are silently ignored.
4. Special actions in 64-bit mode, in addition to legacy-mode actions. Zero or sign extensions apply only to result operands, not source operands. Unless otherwise stated, 8-bit and 16-bit results leave the high 56 or 48 bits, respectively, of 64-bit destination registers unchanged. immediates and branch displacements are sign-extended to 64 bits.
5. Any pointer registers (rDI, rSI) or count registers (rCX) are address-sized and default to 64 bits. For 32-bit address size, any pointer and count registers are zero-extended to 64 bits.
6. The default operand size can be overridden to 16 bits with 66h prefix, but there is no 32-bit operand-size override in 64-bit mode.

B.3 Invalid and Reassigned Instructions in 64-Bit Mode

Table B-2 lists instructions that are illegal in 64-bit mode. Attempted use of these instructions generates an invalid-opcode exception (#UD).

Table B-2. Invalid Instructions in 64-Bit Mode

Mnemonic	Opcode (hex)	Description
AAA	37	ASCII Adjust After Addition
AAD	D5	ASCII Adjust Before Division
AAM	D4	ASCII Adjust After Multiply
AAS	3F	ASCII Adjust After Subtraction
BOUND	62	Check Array Bounds
CALL (far)	9A	Procedure Call Far (far absolute)
DAA	27	Decimal Adjust after Addition
DAS	2F	Decimal Adjust after Subtraction
INTO	CE	Interrupt to Overflow Vector
JMP (far)	EA	Jump Far (absolute)
LDS	C5	Load DS Far Pointer
LES	C4	Load ES Far Pointer
POP DS	1F	Pop Stack into DS Segment
POP ES	07	Pop Stack into ES Segment
POP SS	17	Pop Stack into SS Segment
POPA, POPAD	61	Pop All to GPR Words or Doublewords
PUSH CS	0E	Push CS Segment Selector onto Stack
PUSH DS	1E	Push DS Segment Selector onto Stack
PUSH ES	06	Push ES Segment Selector onto Stack
PUSH SS	16	Push SS Segment Selector onto Stack

Table B-2. Invalid Instructions in 64-Bit Mode (continued)

Mnemonic	Opcode (hex)	Description
PUSHA, PUSHAD	60	Push All to GPR Words or Doublewords
Redundant Grp1	82 /2	Redundant encoding of group1 Eb,lb opcodes
SALC	D6	Set AL According to CF

Table B-3 lists instructions that are reassigned to different functions in 64-bit mode. Attempted use of these instructions generates the reassigned function.

Table B-3. Reassigned Instructions in 64-Bit Mode

Mnemonic	Opcode (hex)	Description
ARPL	63	Opcode for MOVSD instruction in 64-bit mode. In all other modes, this is the Adjust Requestor Privilege Level instruction opcode.
DEC and INC	40-4F	REX prefixes in 64-bit mode. In all other modes, decrement by 1 and increment by 1.

Table B-4 lists instructions that are illegal in long mode. Attempted use of these instructions generates an invalid-opcode exception (#UD).

Table B-4. Invalid Instructions in Long Mode

Mnemonic	Opcode (hex)	Description
SYSENTER	0F 34	System Call
SYSEXIT	0F 35	System Return

B.4 Instructions with 64-Bit Default Operand Size

In 64-bit mode, two groups of instructions default to 64-bit operand size without the need for a REX prefix:

- *Near branches* —CALL, Jcc, JrCX, JMP, LOOP, and RET.

- All instructions, except far branches, that implicitly reference the RSP—CALL, ENTER, LEAVE, POP, PUSH, and RET (CALL and RET are in both groups of instructions).

Table B-5 lists these instructions.

Table B-5. Instructions Defaulting to 64-Bit Operand Size

Mnemonic	Opcode (hex)	Implicitly Reference RSP	Description
CALL	E8, FF /2	yes	Call Procedure Near
ENTER	C8	yes	Create Procedure Stack Frame
Jcc	many	no	Jump Conditional Near
JMP	E9, EB, FF /4	no	Jump Near
LEAVE	C9	yes	Delete Procedure Stack Frame
LOOP	E2	no	Loop
LOOPcc	E0, E1	no	Loop Conditional
POP reg/mem	8F /0	yes	Pop Stack (register or memory)
POP reg	58-5F	yes	Pop Stack (register)
POP FS	0F A1	yes	Pop Stack into FS Segment Register
POP GS	0F A9	yes	Pop Stack into GS Segment Register
POPF, POPFD, POPFQ	9D	yes	Pop to rFLAGS Word, Doubleword, or Quadword
PUSH imm8	6A	yes	Push onto Stack (sign-extended byte)
PUSH imm32	68	yes	Push onto Stack (sign-extended doubleword)
PUSH reg/mem	FF /6	yes	Push onto Stack (register or memory)
PUSH reg	50-57	yes	Push onto Stack (register)
PUSH FS	0F A0	yes	Push FS Segment Register onto Stack

Table B-5. Instructions Defaulting to 64-Bit Operand Size (continued)

Mnemonic	Opcode (hex)	Implicitly Reference RSP	Description
PUSH GS	0F A8	yes	Push GS Segment Register onto Stack
PUSHF, PUSHFD, PUSHFQ	9C	yes	Push rFLAGS Word, Doubleword, or Quadword onto Stack
RET	C2, C3	yes	Return From Call (near)

The 64-bit default operand size can be overridden to 16 bits using the 66h operand-size override. However, it is not possible to override the operand size to 32 bits because there is no 32-bit operand-size override prefix for 64-bit mode. See “Operand-Size Override Prefix” on page 5 for details.

B.5 Single-Byte INC and DEC Instructions in 64-Bit Mode

In 64-bit mode, the legacy encodings for the 16 single-byte INC and DEC instructions (one for each of the eight GPRs) are used to encode the REX prefix values, as described in “REX Prefixes” on page 14. Therefore, these single-byte opcodes for INC and DEC are not available in 64-bit mode, although they are available in legacy and compatibility modes. The functionality of these INC and DEC instructions is still available in 64-bit mode, however, using the ModRM forms of those instructions (opcodes FF/0 and FF/1).

B.6 NOP in 64-Bit Mode

Programs written for the legacy x86 architecture commonly use opcode 90h (the XCHG EAX, EAX instruction) as a one-byte NOP. In 64-bit mode, the processor treats opcode 90h specially in order to preserve this legacy NOP use. Without special handling in 64-bit mode, the instruction would not be a true no-operation. Therefore, in 64-bit mode the processor treats XCHG EAX, EAX as a true NOP, regardless of operand size or the presence of a REX prefix.

This special handling does not apply to the two-byte ModRM form of the XCHG instruction. Unless a 64-bit operand size is

specified using a REX prefix byte, using the two byte form of XCHG to exchange a register with itself will not result in a no-operation because the default operation size is 32 bits in 64-bit mode.

B.7 Segment Override Prefixes in 64-Bit Mode

In 64-bit mode, the CS, DS, ES, SS segment-override prefixes have no effect. These four prefixes are no longer treated as segment-override prefixes in the context of multiple-prefix rules. Instead, they are treated as null prefixes.

The FS and GS segment-override prefixes are treated as true segment-override prefixes in 64-bit mode. Use of the FS and GS prefixes cause their respective segment bases to be added to the effective address calculation. See “FS and GS Registers in 64-Bit Mode” in Volume 2 for details.

Appendix C Differences Between Long Mode and Legacy Mode

Table C-1 summarizes the major differences between 64-bit mode and legacy protected mode. The third column indicates differences between 64-bit mode and legacy mode. The fourth column indicates whether that difference also applies to compatibility mode.

Table C-1. Differences Between Long Mode and Legacy Mode

Type	Subject	64-Bit Mode Difference	Applies To Compatibility Mode?
Application Programming	Addressing	RIP-relative addressing available	no
	Data and Address Sizes	Default data size is 32 bits	
		REX Prefix toggles data size to 64 bits	
		Default address size is 64 bits	
		Address size prefix toggles address size to 32 bits	
	Instruction Differences	Various opcodes are invalid or changed in 64-bit mode (see Table B-2 on page 436 and Table B-3 on page 437)	yes
		Various opcodes are invalid in long mode (see Table B-4 on page 437)	
		MOV reg,imm32 becomes MOV reg,imm64 (with REX operand size prefix)	no
		REX is always enabled	
		Direct-offset forms of MOV to or from accumulator become 64-bit offsets	
MOVD extended to MOV 64 bits between MMX registers and long GPRs (with REX operand-size prefix)			

Table C-1. Differences Between Long Mode and Legacy Mode (continued)

Type	Subject	64-Bit Mode Difference	Applies To Compatibility Mode?
System Programming	x86 Modes	Real and virtual-8086 modes not supported	yes
	Task Switching	Task switching not supported	yes
	Addressing	64-bit virtual addresses	yes
		4-level paging structures	
		PAE must always be enabled	
	Segmentation	CS, DS, ES, SS segment bases are ignored	no
		CS, DS, ES, FS, GS, SS segment limits are ignored	
		CS, DS, ES, SS Segment prefixes are ignored	
	Exception and Interrupt Handling	All pushes are 8 bytes	yes
		16-bit interrupt and trap gates are illegal	
		32-bit interrupt and trap gates are redefined as 64-bit gates and are expanded to 16 bytes	
		SS is set to null on stack switch	
		SS:RSP is pushed unconditionally	
	Call Gates	All pushes are 8 bytes	yes
		16-bit call gates are illegal	
		32-bit call gate type is redefined as 64-bit call gate and is expanded to 16 bytes.	
SS is set to null on stack switch			
System-Descriptor Registers	GDT, IDT, LDT, TR base registers expanded to 64 bits	yes	
System-Descriptor Table Entries and Pseudo-descriptors	LGDT and LIDT use expanded 10-byte pseudo-descriptors.	no	
	LLDT and LTR use expanded 16-byte table entries.		

Appendix D Instruction Subsets and CPUID Feature Sets

Table D-1 is an alphabetical list of the AMD64 instruction set, including the instructions from all five of the instruction subsets that make up the entire AMD64 instruction-set architecture:

- Chapter 3, “General-Purpose Instruction Reference.”
- Chapter 4, “System Instruction Reference.”
- “128-Bit Media Instruction Reference” in Volume 4.
- “64-Bit Media Instruction Reference” in Volume 5.
- “x87 Floating-Point Instruction Reference” in Volume 5.

Several instructions belong to—and are described in—multiple instruction subsets. Table D-1 shows the minimum current privilege level (CPL) required to execute each instruction and the instruction subset(s) to which the instruction belongs. For each instruction subset, the CPUID feature set(s) that enables the instruction is shown.

D.1 Instruction Subsets

Figure D-1 on page 444 shows the relationship between the five instruction subsets and the CPUID feature sets. Dashed-line polygons represent the instruction subsets. Circles represent the major CPUID feature sets that enable various classes of instructions. (There are a few additional CPUID feature sets, not shown, each of which apply to only a few instructions.)

The overlapping of the 128-bit and 64-bit media instruction subsets indicates that these subsets share some common mnemonics. However, these common mnemonics either have distinct opcodes for each subset or they take operands in both the MMX and XMM register sets.

The horizontal axis of Figure D-1 shows how the subsets and CPUID feature sets have evolved over time.

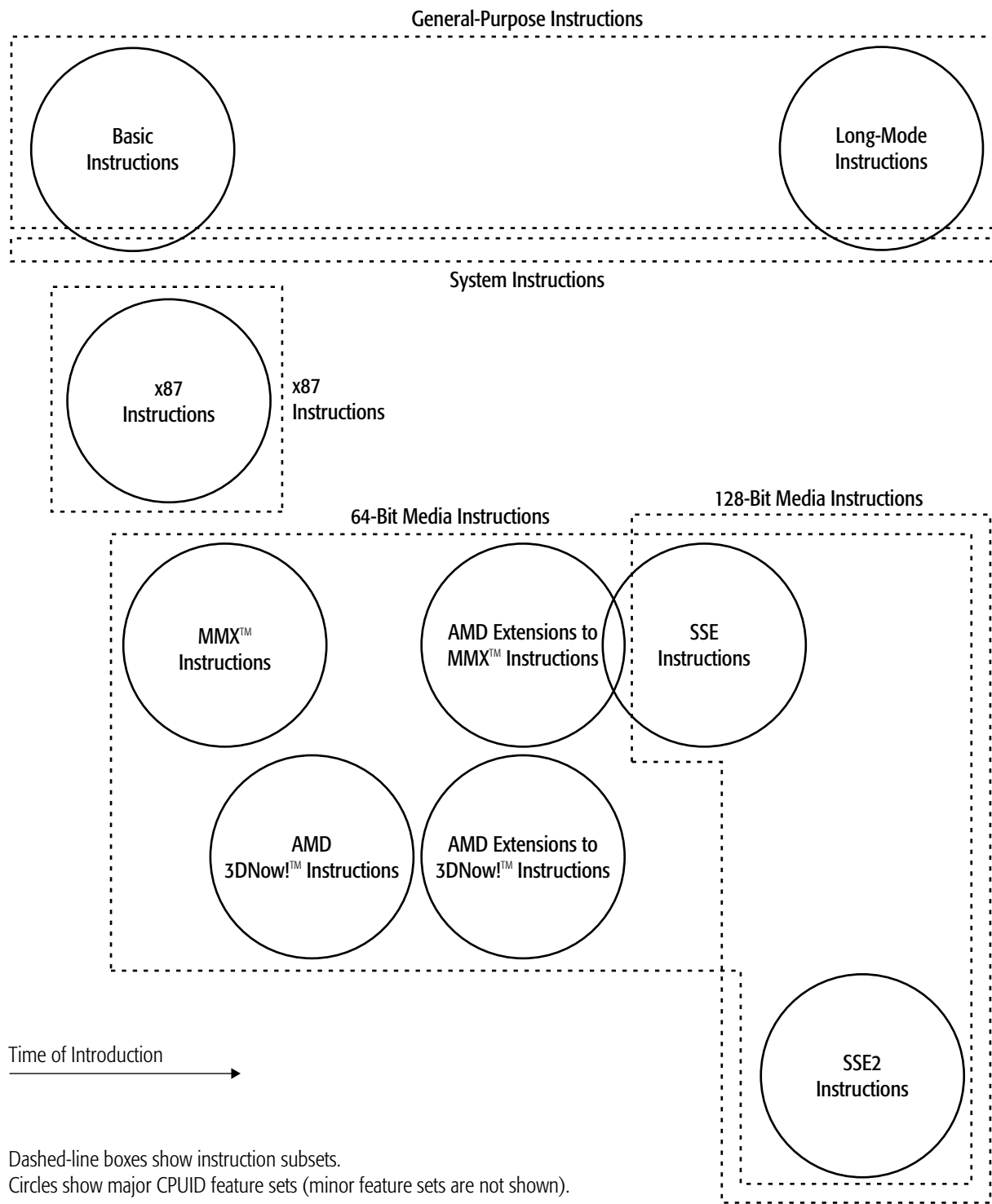

513-328.eps

Figure D-1. Instruction Subsets vs. CPUID Feature Sets

D.2 CPUID Feature Sets

The CPUID feature sets shown in Figure D-1 and listed in Table D-1 on page 447 include:

- *Basic Instructions*—Instructions that are supported in all hardware implementations of the AMD64 architecture, except that the following instructions are implemented only if their associated CPUID function bit is set:
 - CLFLUSH, indicated by bit 19 of CPUID standard function 1.
 - CMPXCHG8B, indicated by bit 8 of CPUID standard function 1 and extended function 8000_0001h.
 - CMOV_{cc} (conditional moves), indicated by bit 15 of CPUID standard function 1 and extended function 8000_0001h.
 - RDMSR and WRMSR, indicated by bit 5 of CPUID standard function 1 and extended function 8000_0001h.
 - RDTSC, indicated by bit 4 of CPUID standard function 1 and extended function 8000_0001h.
 - SYSCALL and SYSRET, indicated by bit 11 of CPUID extended function 8000_0001h.
 - SYSENTER and SYSEXIT, indicated by bit 11 of CPUID standard function 1.
- *x87 Instructions*—Legacy floating-point instructions that use the ST(0)–ST(7) stack registers (FPR0–FPR7 physical registers) and are supported if the following bits are set:
 - On-chip floating-point unit, indicated by bit 0 of CPUID standard function 1 and extended function 8000_0001h.
 - FCMOV_{cc} (conditional moves), indicated by bit 15 of CPUID standard function 1 and extended function 8000_0001h. This bit indicates support for x87 floating-point conditional moves (FCMOV_{cc}) whenever the On-Chip Floating-Point Unit bit (bit 0) is also set.
- *MMX™ Instructions*—Vector integer instructions that are implemented in the MMX instruction set, use the MMX logical registers (FPR0–FPR7 physical registers), and are supported if the following bit is set:
 - MMX instructions, indicated by bit 23 of CPUID standard function 1 and extended function 8000_0001h.

- *AMD 3DNow!™ Instructions*—Vector floating-point instructions that comprise the AMD 3DNow! technology, use the MMX logical registers (FPR0–FPR7 physical registers), and are supported if the following bit is set:
 - AMD 3DNow! instructions, indicated by bit 31 of CPUID extended function 8000_0001h.
- *AMD Extensions to MMX™ Instructions*—Vector integer instructions that use the MMX registers and are supported if the following bit is set:
 - AMD extensions to MMX instructions, indicated by bit 22 of CPUID extended function 8000_0001h.
- *AMD Extensions to 3DNow!™ Instructions*—Vector floating-point instructions that use the MMX registers and are supported if the following bit is set:
 - AMD extensions to 3DNow! instructions, indicated by bit 30 of CPUID extended function 8000_0001h.
- *SSE Instructions*—Vector integer instructions that use the MMX registers, single-precision vector and scalar floating-point instructions that use the XMM registers, plus other instructions for data-type conversion, prefetching, cache control, and memory-access ordering. These instructions are supported if the following bits are set:
 - SSE, indicated by bit 25 of CPUID standard function 1.
 - FXSAVE and FXRSTOR, indicated by bit 24 of CPUID standard function 1 and extended function 8000_0001h.Several SSE opcodes are also implemented by the AMD Extensions to MMX™ Instructions.

- *SSE2 Instructions*—Vector and scalar integer and double-precision floating-point instructions that use the XMM registers, plus other instructions for data-type conversion, cache control, and memory-access ordering. These instructions are supported if the following bit is set:
 - SSE2, indicated by bit 26 of CPUID standard function 1.Several instructions originally implemented as MMX™ instructions are extended in the SSE2 instruction set to include opcodes that use XMM registers.

- *Long-Mode Instructions*—Instructions introduced by AMD with the AMD64 architecture. These instructions are supported if the following bit is set:
 - Long mode, indicated by bit 29 of CPUID extended function 8000_0001h.

For complete details on the CPUID feature sets listed in Table D-1, see “Processor Feature Identification” in Volume 2.

D.3 Instruction List

Table D-1. Instruction Subsets and CPUID Feature Sets

Instruction			Instruction Subset and CPUID Feature Set(s) ¹				
Mnemonic	Description	CPL	General-Purpose	128-Bit Media	64-Bit Media	x87	System
AAA	ASCII Adjust After Addition	3	Basic				
AAD	ASCII Adjust Before Division	3	Basic				
AAM	ASCII Adjust After Multiply	3	Basic				
AAS	ASCII Adjust After Subtraction	3	Basic				
ADC	Add with Carry	3	Basic				
ADD	Signed or Unsigned Add	3	Basic				
ADDPD	Add Packed Double-Precision Floating-Point	3		SSE2			
ADDPS	Add Packed Single-Precision Floating-Point	3		SSE			
ADDSD	Add Scalar Double-Precision Floating-Point	3		SSE2			
ADDSS	Add Scalar Single-Precision Floating-Point	3		SSE			

1. Columns indicate the instruction subsets. Entries indicate the CPUID feature set(s) to which the instruction belongs.
 2. Mnemonic is used for two different instructions. Assemblers can distinguish them by the number and type of operands.

Table D-1. Instruction Subsets and CPUID Feature Sets (continued)

Instruction			Instruction Subset and CPUID Feature Set(s) ¹				
Mnemonic	Description	CPL	General-Purpose	128-Bit Media	64-Bit Media	x87	System
AND	Logical AND	3	Basic				
ANDNPD	Logical Bitwise AND NOT Packed Double-Precision Floating-Point	3		SSE2			
ANDNPS	Logical Bitwise AND NOT Packed Single-Precision Floating-Point	3		SSE			
ANDPD	Logical Bitwise AND Packed Double-Precision Floating-Point	3		SSE2			
ANDPS	Logical Bitwise AND Packed Single-Precision Floating-Point	3		SSE			
ARPL	Adjust Requestor Privilege Level	3					Basic
BOUND	Check Array Bounds	3	Basic				
BSF	Bit Scan Forward	3	Basic				
BSR	Bit Scan Reverse	3	Basic				
BSWAP	Byte Swap	3	Basic				
BT	Bit Test	3	Basic				
BTC	Bit Test and Complement	3	Basic				
BTR	Bit Test and Reset	3	Basic				
BTS	Bit Test and Set	3	Basic				
CALL	Procedure Call	3	Basic				
CBW	Convert Byte to Word	3	Basic				
CDQ	Convert Doubleword to Quadword	3	Basic				

1. Columns indicate the instruction subsets. Entries indicate the CPUID feature set(s) to which the instruction belongs.
2. Mnemonic is used for two different instructions. Assemblers can distinguish them by the number and type of operands.

Table D-1. Instruction Subsets and CUID Feature Sets (continued)

Instruction			Instruction Subset and CUID Feature Set(s) ¹				
Mnemonic	Description	CPL	General-Purpose	128-Bit Media	64-Bit Media	x87	System
CDQE	Convert Doubleword to Quadword	3	Long Mode				
CLC	Clear Carry Flag	3	Basic				
CLD	Clear Direction Flag	3	Basic				
CLFLUSH	Cache Line Flush	3	CLFLUSH				
CLI	Clear Interrupt Flag	3					Basic
CLTS	Clear Task-Switched Flag in CR0	0					Basic
CMC	Complement Carry Flag	3	Basic				
CMOVcc	Conditional Move	3	CMOVcc				
CMP	Compare	3	Basic				
CMPPD	Compare Packed Double-Precision Floating-Point	3		SSE2			
CMPPS	Compare Packed Single-Precision Floating-Point	3		SSE			
CMPS	Compare Strings	3	Basic				
CMPSB	Compare Strings by Byte	3	Basic				
CMPSD	Compare Strings by Doubleword	3	Basic ²				
CMPSD	Compare Scalar Double-Precision Floating-Point	3		SSE2 ²			
CMPSQ	Compare Strings by Quadword	3	Long Mode				
CMPSQ	Compare Scalar Single-Precision Floating-Point	3		SSE			

1. Columns indicate the instruction subsets. Entries indicate the CUID feature set(s) to which the instruction belongs.
2. Mnemonic is used for two different instructions. Assemblers can distinguish them by the number and type of operands.

Table D-1. Instruction Subsets and CUID Feature Sets (continued)

Instruction			Instruction Subset and CUID Feature Set(s) ¹				
Mnemonic	Description	CPL	General-Purpose	128-Bit Media	64-Bit Media	x87	System
CMPSW	Compare Strings by Word	3	Basic				
CMPXCHG	Compare and Exchange	3	Basic				
CMPXCHG8B	Compare and Exchange Eight Bytes	3	CMPXCHG8B				
COMISD	Compare Ordered Scalar Double-Precision Floating-Point	3		SSE2			
COMISS	Compare Ordered Scalar Single-Precision Floating-Point	3		SSE			
CPUID	Processor Identification	3	Basic				
CQO	Convert Quadword to Double Quadword	3	Long Mode				
CVTDQ2PD	Convert Packed Doubleword Integers to Packed Double-Precision Floating-Point	3		SSE2			
CVTDQ2PS	Convert Packed Doubleword Integers to Packed Single-Precision Floating-Point	3		SSE2			
CVTPD2DQ	Convert Packed Double-Precision Floating-Point to Packed Doubleword Integers	3		SSE2			
CVTPD2PI	Convert Packed Double-Precision Floating-Point to Packed Doubleword Integers	3		SSE2	SSE2		

1. Columns indicate the instruction subsets. Entries indicate the CUID feature set(s) to which the instruction belongs.
2. Mnemonic is used for two different instructions. Assemblers can distinguish them by the number and type of operands.

Table D-1. Instruction Subsets and CUID Feature Sets (continued)

Instruction			Instruction Subset and CUID Feature Set(s) ¹				
Mnemonic	Description	CPL	General-Purpose	128-Bit Media	64-Bit Media	x87	System
CVTPD2PS	Convert Packed Double-Precision Floating-Point to Packed Single-Precision Floating-Point	3		SSE2			
CVTPI2PD	Convert Packed Doubleword Integers to Packed Double-Precision Floating-Point	3		SSE2	SSE2		
CVTPI2PS	Convert Packed Doubleword Integers to Packed Single-Precision Floating-Point	3		SSE	SSE		
CVTPS2DQ	Convert Packed Single-Precision Floating-Point to Packed Doubleword Integers	3		SSE2			
CVTPS2PD	Convert Packed Single-Precision Floating-Point to Packed Double-Precision Floating-Point	3		SSE2			
CVTPS2PI	Convert Packed Single-Precision Floating-Point to Packed Doubleword Integers	3		SSE	SSE		
CVTSD2SI	Convert Scalar Double-Precision Floating-Point to Signed Doubleword or Quadword Integer	3		SSE2			
CVTSD2SS	Convert Scalar Double-Precision Floating-Point to Scalar Single-Precision Floating-Point	3		SSE2			

1. Columns indicate the instruction subsets. Entries indicate the CUID feature set(s) to which the instruction belongs.

2. Mnemonic is used for two different instructions. Assemblers can distinguish them by the number and type of operands.

Table D-1. Instruction Subsets and CPUID Feature Sets (continued)

Instruction			Instruction Subset and CPUID Feature Set(s) ¹				
Mnemonic	Description	CPL	General-Purpose	128-Bit Media	64-Bit Media	x87	System
CVTSI2SD	Convert Signed Doubleword or Quadword Integer to Scalar Double-Precision Floating-Point	3		SSE2			
CVTSI2SS	Convert Signed Doubleword or Quadword Integer to Scalar Single-Precision Floating-Point	3		SSE			
CVTSS2SD	Convert Scalar Single-Precision Floating-Point to Scalar Double-Precision Floating-Point	3		SSE2			
CVTSS2SI	Convert Scalar Single-Precision Floating-Point to Signed Doubleword or Quadword Integer	3		SSE			
CVTTPD2DQ	Convert Packed Double-Precision Floating-Point to Packed Doubleword Integers, Truncated	3		SSE2			
CVTTPD2PI	Convert Packed Double-Precision Floating-Point to Packed Doubleword Integers, Truncated	3		SSE2	SSE2		
CVTTPS2DQ	Convert Packed Single-Precision Floating-Point to Packed Doubleword Integers, Truncated	3		SSE2			

1. Columns indicate the instruction subsets. Entries indicate the CPUID feature set(s) to which the instruction belongs.

2. Mnemonic is used for two different instructions. Assemblers can distinguish them by the number and type of operands.

Table D-1. Instruction Subsets and CUID Feature Sets (continued)

Instruction			Instruction Subset and CUID Feature Set(s) ¹				
Mnemonic	Description	CPL	General-Purpose	128-Bit Media	64-Bit Media	x87	System
CVTTPS2PI	Convert Packed Single-Precision Floating-Point to Packed Doubleword Integers, Truncated	3		SSE	SSE		
CVTTSD2SI	Convert Scalar Double-Precision Floating-Point to Signed Doubleword or Quadword Integer, Truncated	3		SSE2			
CVTTSS2SI	Convert Scalar Single-Precision Floating-Point to Signed Doubleword or Quadword Integer, Truncated	3		SSE			
CWD	Convert Word to Doubleword	3	Basic				
CWDE	Convert Word to Doubleword	3	Basic				
DAA	Decimal Adjust after Addition	3	Basic				
DAS	Decimal Adjust after Subtraction	3	Basic				
DEC	Decrement by 1	3	Basic				
DIV	Unsigned Divide	3	Basic				
DIVPD	Divide Packed Double-Precision Floating-Point	3		SSE2			
DIVPS	Divide Packed Single-Precision Floating-Point	3		SSE			
DIVSD	Divide Scalar Double-Precision Floating-Point	3		SSE2			

1. Columns indicate the instruction subsets. Entries indicate the CUID feature set(s) to which the instruction belongs.

2. Mnemonic is used for two different instructions. Assemblers can distinguish them by the number and type of operands.

Table D-1. Instruction Subsets and CPUID Feature Sets (continued)

Instruction			Instruction Subset and CPUID Feature Set(s) ¹				
Mnemonic	Description	CPL	General-Purpose	128-Bit Media	64-Bit Media	x87	System
DIVSS	Divide Scalar Single-Precision Floating-Point	3		SSE			
EMMS	Enter/Exit Multimedia State	3			MMX™	MMX	
ENTER	Create Procedure Stack Frame	3	Basic				
F2XM1	Floating-Point Compute 2x-1	3				X87	
FABS	Floating-Point Absolute Value	3				X87	
FADD	Floating-Point Add	3				X87	
FADDP	Floating-Point Add and Pop	3				X87	
FBLD	Floating-Point Load Binary-Coded Decimal	3				X87	
FBSTP	Floating-Point Store Binary-Coded Decimal Integer and Pop	3				X87	
FCHS	Floating-Point Change Sign	3				X87	
FCLEX	Floating-Point Clear Flags	3				X87	
FCMOVB	Floating-Point Conditional Move If Below	3				X87, CMOVcc	
FCMOVBE	Floating-Point Conditional Move If Below or Equal	3				X87, CMOVcc	

1. Columns indicate the instruction subsets. Entries indicate the CPUID feature set(s) to which the instruction belongs.
2. Mnemonic is used for two different instructions. Assemblers can distinguish them by the number and type of operands.

Table D-1. Instruction Subsets and CPUID Feature Sets (continued)

Instruction			Instruction Subset and CPUID Feature Set(s) ¹				
Mnemonic	Description	CPL	General-Purpose	128-Bit Media	64-Bit Media	x87	System
FCMOVE	Floating-Point Conditional Move If Equal	3				X87, CMOVcc	
FCMOVNB	Floating-Point Conditional Move If Not Below	3				X87, CMOVcc	
FCMOVNBE	Floating-Point Conditional Move If Not Below or Equal	3				X87, CMOVcc	
FCMOVNE	Floating-Point Conditional Move If Not Equal	3				X87, CMOVcc	
FCMOVNU	Floating-Point Conditional Move If Not Unordered	3				X87, CMOVcc	
FCMOVU	Floating-Point Conditional Move If Unordered	3				X87, CMOVcc	
FCOM	Floating-Point Compare	3				X87	
FCOMI	Floating-Point Compare and Set Flags	3				X87	
FCOMIP	Floating-Point Compare and Set Flags and Pop	3				X87	
FCOMP	Floating-Point Compare and Pop	3				X87	
FCOMPP	Floating-Point Compare and Pop Twice	3				X87	
FCOS	Floating-Point Cosine	3				X87	

1. Columns indicate the instruction subsets. Entries indicate the CPUID feature set(s) to which the instruction belongs.

2. Mnemonic is used for two different instructions. Assemblers can distinguish them by the number and type of operands.

Table D-1. Instruction Subsets and CPUID Feature Sets (continued)

Instruction			Instruction Subset and CPUID Feature Set(s) ¹				
Mnemonic	Description	CPL	General-Purpose	128-Bit Media	64-Bit Media	x87	System
FDECSTP	Floating-Point Decrement Stack-Top Pointer	3				X87	
FDIV	Floating-Point Divide	3				X87	
FDIVP	Floating-Point Divide and Pop	3				X87	
FDIVR	Floating-Point Divide Reverse	3				X87	
FDIVRP	Floating-Point Divide Reverse and Pop	3				X87	
FEMMS	Fast Enter/Exit Multimedia State	3			3DNow!™	3DNow!	
FFREE	Free Floating-Point Register	3				X87	
FIADD	Floating-Point Add Integer to Stack Top	3				X87	
FICOM	Floating-Point Integer Compare	3				X87	
FICOMP	Floating-Point Integer Compare and Pop	3				X87	
FIDIV	Floating-Point Integer Divide	3				X87	
FIDIVR	Floating-Point Integer Divide Reverse	3				X87	
FILD	Floating-Point Load Integer	3				X87	
FIMUL	Floating-Point Integer Multiply	3				X87	

1. Columns indicate the instruction subsets. Entries indicate the CPUID feature set(s) to which the instruction belongs.
2. Mnemonic is used for two different instructions. Assemblers can distinguish them by the number and type of operands.

Table D-1. Instruction Subsets and CUID Feature Sets (continued)

Instruction			Instruction Subset and CUID Feature Set(s) ¹				
Mnemonic	Description	CPL	General-Purpose	128-Bit Media	64-Bit Media	x87	System
FINCSTP	Floating-Point Increment Stack-Top Pointer	3				X87	
FINIT	Floating-Point Initialize	3				X87	
FIST	Floating-Point Integer Store	3				X87	
FISTP	Floating-Point Integer Store and Pop	3				X87	
FISUB	Floating-Point Integer Subtract	3				X87	
FISUBR	Floating-Point Integer Subtract Reverse	3				X87	
FLD	Floating-Point Load	3				X87	
FLD1	Floating-Point Load +1.0	3				X87	
FLDCW	Floating-Point Load x87 Control Word	3				X87	
FLDENV	Floating-Point Load x87 Environment	3				X87	
FLDL2E	Floating-Point Load $\log_2 e$	3				X87	
FLDL2T	Floating-Point Load $\log_2 10$	3				X87	
FLDLG2	Floating-Point Load $\log_{10} 2$	3				X87	
FLDLN2	Floating-Point Load $\ln 2$	3				X87	
FLDPI	Floating-Point Load π	3				X87	
FLDZ	Floating-Point Load +0.0	3				X87	
FMUL	Floating-Point Multiply	3				X87	

1. Columns indicate the instruction subsets. Entries indicate the CUID feature set(s) to which the instruction belongs.

2. Mnemonic is used for two different instructions. Assemblers can distinguish them by the number and type of operands.

Table D-1. Instruction Subsets and CUID Feature Sets (continued)

Instruction			Instruction Subset and CUID Feature Set(s) ¹				
Mnemonic	Description	CPL	General-Purpose	128-Bit Media	64-Bit Media	x87	System
FMULP	Floating-Point Multiply and Pop	3				X87	
FNCLEX	Floating-Point No-Wait Clear Flags	3				X87	
FNINIT	Floating-Point No-Wait Initialize	3				X87	
FNOP	Floating-Point No Operation	3				X87	
FNSAVE	Save No-Wait x87 and MMX State	3			X87	X87	
FNSTCW	Floating-Point No-Wait Store x87 Control Word	3				X87	
FNSTENV	Floating-Point No-Wait Store x87 Environment	3				X87	
FNSTSW	Floating-Point No-Wait Store x87 Status Word	3				X87	
FPATAN	Floating-Point Partial Arctangent	3				X87	
FPREM	Floating-Point Partial Remainder	3				X87	
FPREM1	Floating-Point Partial Remainder	3				X87	
FPTAN	Floating-Point Partial Tangent	3				X87	
FRNDINT	Floating-Point Round to Integer	3				X87	
FRSTOR	Restore x87 and MMX State	3			X87	X87	
FSAVE	Save x87 and MMX State	3			X87	X87	

1. Columns indicate the instruction subsets. Entries indicate the CUID feature set(s) to which the instruction belongs.
 2. Mnemonic is used for two different instructions. Assemblers can distinguish them by the number and type of operands.

Table D-1. Instruction Subsets and CPUID Feature Sets (continued)

Instruction			Instruction Subset and CPUID Feature Set(s) ¹				
Mnemonic	Description	CPL	General-Purpose	128-Bit Media	64-Bit Media	x87	System
FSCALE	Floating-Point Scale	3				X87	
FSIN	Floating-Point Sine	3				X87	
FSINCOS	Floating-Point Sine and Cosine	3				X87	
FSQRT	Floating-Point Square Root	3				X87	
FST	Floating-Point Store Stack Top	3				X87	
FSTCW	Floating-Point Store x87 Control Word	3				X87	
FSTENV	Floating-Point Store x87 Environment	3				X87	
FSTP	Floating-Point Store Stack Top and Pop	3				X87	
FSTSW	Floating-Point Store x87 Status Word	3				X87	
FSUB	Floating-Point Subtract	3				X87	
FSUBP	Floating-Point Subtract and Pop	3				X87	
FSUBR	Floating-Point Subtract Reverse	3				X87	
FSUBRP	Floating-Point Subtract Reverse and Pop	3				X87	
FTST	Floating-Point Test with Zero	3				X87	
FUCOM	Floating-Point Unordered Compare	3				X87	

1. Columns indicate the instruction subsets. Entries indicate the CPUID feature set(s) to which the instruction belongs.

2. Mnemonic is used for two different instructions. Assemblers can distinguish them by the number and type of operands.

Table D-1. Instruction Subsets and CUID Feature Sets (continued)

Instruction			Instruction Subset and CUID Feature Set(s) ¹				
Mnemonic	Description	CPL	General-Purpose	128-Bit Media	64-Bit Media	x87	System
FUCOMI	Floating-Point Unordered Compare and Set Flags	3				X87	
FUCOMIP	Floating-Point Unordered Compare and Set Flags and Pop	3				X87	
FUCOMP	Floating-Point Unordered Compare and Pop	3				X87	
FUCOMPP	Floating-Point Unordered Compare and Pop Twice	3				X87	
FWAIT	Wait for x87 Floating-Point Exceptions	3				X87	
FXAM	Floating-Point Examine	3				X87	
FXCH	Floating-Point Exchange	3				X87	
FXRSTOR	Restore XMM, MMX, and x87 State	3		FXSAVE, FXRSTOR	FXSAVE, FXRSTOR	FXSAVE, FXRSTOR	
FXSAVE	Save XMM, MMX, and x87 State	3		FXSAVE, FXRSTOR	FXSAVE, FXRSTOR	FXSAVE, FXRSTOR	
EXTRACT	Floating-Point Extract Exponent and Significand	3				X87	
FYL2X	Floating-Point $y * \log_2 x$	3				X87	
FYL2XP1	Floating-Point $y * \log_2(x + 1)$	3				X87	
HLT	Halt	0					Basic
IDIV	Signed Divide	3	Basic				
IMUL	Signed Multiply	3	Basic				

1. Columns indicate the instruction subsets. Entries indicate the CUID feature set(s) to which the instruction belongs.
2. Mnemonic is used for two different instructions. Assemblers can distinguish them by the number and type of operands.

Table D-1. Instruction Subsets and CPUID Feature Sets (continued)

Instruction			Instruction Subset and CPUID Feature Set(s) ¹				
Mnemonic	Description	CPL	General-Purpose	128-Bit Media	64-Bit Media	x87	System
IN	Input from Port	3	Basic				
INC	Increment by 1	3	Basic				
INS	Input String	3	Basic				
INSB	Input String Byte	3	Basic				
INSD	Input String Doubleword	3	Basic				
INSW	Input String Word	3	Basic				
INT	Interrupt to Vector	3	Basic				
INT 3	Interrupt to Debug Vector	3					Basic
INTO	Interrupt to Overflow Vector	3	Basic				
INVD	Invalidate Caches	0					Basic
INVLPG	Invalidate TLB Entry	0					Basic
IRET	Interrupt Return Word	3					Basic
IRETD	Interrupt Return Doubleword	3					Basic
IRETQ	Interrupt Return Quadword	3					Long Mode
Jcc	Jump Condition	3	Basic				
JCXZ	Jump if CX Zero	3	Basic				
JECXZ	Jump if ECX Zero	3	Basic				
JMP	Jump	3	Basic				
JRCXZ	Jump if RCX Zero	3	Basic				
LAHF	Load Status Flags into AH Register	3	Basic				

1. Columns indicate the instruction subsets. Entries indicate the CPUID feature set(s) to which the instruction belongs.
2. Mnemonic is used for two different instructions. Assemblers can distinguish them by the number and type of operands.

Table D-1. Instruction Subsets and CPUID Feature Sets (continued)

Instruction			Instruction Subset and CPUID Feature Set(s) ¹				
Mnemonic	Description	CPL	General-Purpose	128-Bit Media	64-Bit Media	x87	System
LAR	Load Access Rights Byte	3					Basic
LDMXCSR	Load MXCSR Control/Status Register	3		SSE			
LDS	Load DS Far Pointer	3	Basic				
LEA	Load Effective Address	3	Basic				
LEAVE	Delete Procedure Stack Frame	3	Basic				
LES	Load ES Far Pointer	3	Basic				
LFENCE	Load Fence	3	SSE2				
LFS	Load FS Far Pointer	3	Basic				
LGDT	Load Global Descriptor Table Register	0					Basic
LGS	Load GS Far Pointer	3	Basic				
LIDT	Load Interrupt Descriptor Table Register	0					Basic
LLDT	Load Local Descriptor Table Register	0					Basic
LMSW	Load Machine Status Word	0					Basic
LODS	Load String	3	Basic				
LODSB	Load String Byte	3	Basic				
LODSD	Load String Doubleword	3	Basic				
LODSQ	Load String Quadword	3	Long Mode				
LODSW	Load String Word	3	Basic				
LOOP	Loop	3	Basic				
LOOPE	Loop if Equal	3	Basic				

1. Columns indicate the instruction subsets. Entries indicate the CPUID feature set(s) to which the instruction belongs.
2. Mnemonic is used for two different instructions. Assemblers can distinguish them by the number and type of operands.

Table D-1. Instruction Subsets and CUID Feature Sets (continued)

Instruction			Instruction Subset and CUID Feature Set(s) ¹				
Mnemonic	Description	CPL	General-Purpose	128-Bit Media	64-Bit Media	x87	System
LOOPNE	Loop if Not Equal	3	Basic				
LOOPNZ	Loop if Not Zero	3	Basic				
LOOPZ	Loop if Zero	3	Basic				
LSL	Load Segment Limit	3	Basic				
LSS	Load SS Segment Register	3	Basic				
LTR	Load Task Register	0					Basic
MASKMOVDQU	Masked Move Double Quadword Unaligned	3		SSE2			
MASKMOVQ	Masked Move Quadword	3			SSE, MMX™ Extensions		
MAXPD	Maximum Packed Double-Precision Floating-Point	3		SSE2			
MAXPS	Maximum Packed Single-Precision Floating-Point	3		SSE			
MAXSD	Maximum Scalar Double-Precision Floating-Point	3		SSE2			
MAXSS	Maximum Scalar Single-Precision Floating-Point	3		SSE			
MFENCE	Memory Fence	3	SSE2				
MINPD	Minimum Packed Double-Precision Floating-Point	3		SSE2			
MINPS	Minimum Packed Single-Precision Floating-Point	3		SSE			

1. Columns indicate the instruction subsets. Entries indicate the CUID feature set(s) to which the instruction belongs.

2. Mnemonic is used for two different instructions. Assemblers can distinguish them by the number and type of operands.

Table D-1. Instruction Subsets and CPUID Feature Sets (continued)

Instruction			Instruction Subset and CPUID Feature Set(s) ¹				
Mnemonic	Description	CPL	General-Purpose	128-Bit Media	64-Bit Media	x87	System
MINSD	Minimum Scalar Double-Precision Floating-Point	3		SSE2			
MINSS	Minimum Scalar Single-Precision Floating-Point	3		SSE			
MOV	Move	3	Basic				
MOV CRn	Move to/from Control Registers	0					Basic
MOV DRn	Move to/from Debug Registers	0					Basic
MOVAPD	Move Aligned Packed Double-Precision Floating-Point	3		SSE2			
MOVAPS	Move Aligned Packed Single-Precision Floating-Point	3		SSE			
MOVD	Move Doubleword or Quadword	3	MMX, SSE2	SSE2	MMX™		
MOVDQ2Q	Move Quadword to Quadword	3		SSE2	SSE2		
MOVDQA	Move Aligned Double Quadword	3		SSE2			
MOVDQU	Move Unaligned Double Quadword	3		SSE2			
MOVHPS	Move Packed Single-Precision Floating-Point High to Low	3		SSE			
MOVHPD	Move High Packed Double-Precision Floating-Point	3		SSE2			

1. Columns indicate the instruction subsets. Entries indicate the CPUID feature set(s) to which the instruction belongs.
 2. Mnemonic is used for two different instructions. Assemblers can distinguish them by the number and type of operands.

Table D-1. Instruction Subsets and CPUID Feature Sets (continued)

Instruction			Instruction Subset and CPUID Feature Set(s) ¹				
Mnemonic	Description	CPL	General-Purpose	128-Bit Media	64-Bit Media	x87	System
MOVHPS	Move High Packed Single-Precision Floating-Point	3		SSE			
MOVLHPS	Move Packed Single-Precision Floating-Point Low to High	3		SSE			
MOVLPD	Move Low Packed Double-Precision Floating-Point	3		SSE2			
MOVLPS	Move Low Packed Single-Precision Floating-Point	3		SSE			
MOVMSKPD	Extract Packed Double-Precision Floating-Point Sign Mask	3	SSE2	SSE2			
MOVMSKPS	Extract Packed Single-Precision Floating-Point Sign Mask	3	SSE	SSE			
MOVNTDQ	Move Non-Temporal Double Quadword	3		SSE2			
MOVNTI	Move Non-Temporal Doubleword or Quadword	3	SSE2				
MOVNTPD	Move Non-Temporal Packed Double-Precision Floating-Point	3		SSE2			
MOVNTPS	Move Non-Temporal Packed Single-Precision Floating-Point	3		SSE			
MOVNTQ	Move Non-Temporal Quadword	3			SSE, MMX Extensions		

1. Columns indicate the instruction subsets. Entries indicate the CPUID feature set(s) to which the instruction belongs.

2. Mnemonic is used for two different instructions. Assemblers can distinguish them by the number and type of operands.

Table D-1. Instruction Subsets and CPUID Feature Sets (continued)

Instruction			Instruction Subset and CPUID Feature Set(s) ¹				
Mnemonic	Description	CPL	General-Purpose	128-Bit Media	64-Bit Media	x87	System
MOVQ	Move Quadword	3		SSE2	MMX™		
MOVQ2DQ	Move Quadword to Quadword	3		SSE2	SSE2		
MOVS	Move String	3	Basic				
MOVSB	Move String Byte	3	Basic				
MOVSD	Move String Doubleword	3	Basic ²				
MOVSD	Move Scalar Double-Precision Floating-Point	3		SSE2 ²			
MOVSQ	Move String Quadword	3	Long Mode				
MOVSS	Move Scalar Single-Precision Floating-Point	3		SSE			
MOVSW	Move String Word	3	Basic				
MOVSX	Move with Sign-Extend	3	Basic				
MOVXSD	Move with Sign-Extend Doubleword	3	Long Mode				
MOVUPD	Move Unaligned Packed Double-Precision Floating-Point	3		SSE2			
MOVUPS	Move Unaligned Packed Single-Precision Floating-Point	3		SSE			
MOVZX	Move with Zero-Extend	3	Basic				
MUL	Multiply Unsigned	3	Basic				
MULPD	Multiply Packed Double-Precision Floating-Point	3		SSE2			
MULPS	Multiply Packed Single-Precision Floating-Point	3		SSE			

1. Columns indicate the instruction subsets. Entries indicate the CPUID feature set(s) to which the instruction belongs.
 2. Mnemonic is used for two different instructions. Assemblers can distinguish them by the number and type of operands.

Table D-1. Instruction Subsets and CUID Feature Sets (continued)

Instruction			Instruction Subset and CUID Feature Set(s) ¹				
Mnemonic	Description	CPL	General-Purpose	128-Bit Media	64-Bit Media	x87	System
MULSD	Multiply Scalar Double-Precision Floating-Point	3		SSE2			
MULSS	Multiply Scalar Single-Precision Floating-Point	3		SSE			
NEG	Two's Complement Negation	3	Basic				
NOP	No Operation	3	Basic				
NOT	One's Complement Negation	3	Basic				
OR	Logical OR	3	Basic				
ORPD	Logical Bitwise OR Packed Double-Precision Floating-Point	3		SSE2			
ORPS	Logical Bitwise OR Packed Single-Precision Floating-Point	3		SSE			
OUT	Output to Port	3	Basic				
OUTS	Output String	3	Basic				
OUTSB	Output String Byte	3	Basic				
OUTSD	Output String Doubleword	3	Basic				
OUTSW	Output String Word	3	Basic				
PACKSSDW	Pack with Saturation Signed Doubleword to Word	3		SSE2	MMX™		
PACKSSWB	Pack with Saturation Signed Word to Byte	3		SSE2	MMX		

1. Columns indicate the instruction subsets. Entries indicate the CUID feature set(s) to which the instruction belongs.
2. Mnemonic is used for two different instructions. Assemblers can distinguish them by the number and type of operands.

Table D-1. Instruction Subsets and CPUID Feature Sets (continued)

Instruction			Instruction Subset and CPUID Feature Set(s) ¹				
Mnemonic	Description	CPL	General-Purpose	128-Bit Media	64-Bit Media	x87	System
PACKUSWB	Pack with Saturation Signed Word to Unsigned Byte	3		SSE2	MMX™		
PADDB	Packed Add Bytes	3		SSE2	MMX		
PADDD	Packed Add Doublewords	3		SSE2	MMX		
PADDQ	Packed Add Quadwords	3		SSE2	SSE2		
PADDSB	Packed Add Signed with Saturation Bytes	3		SSE2	MMX		
PADDSW	Packed Add Signed with Saturation Words	3		SSE2	MMX		
PADDUSB	Packed Add Unsigned with Saturation Bytes	3		SSE2	MMX		
PADDUSW	Packed Add Unsigned with Saturation Words	3		SSE2	MMX		
PADDW	Packed Add Words	3		SSE2	MMX		
PAND	Packed Logical Bitwise AND	3		SSE2	MMX		
PANDN	Packed Logical Bitwise AND NOT	3		SSE2	MMX		
PAVGB	Packed Average Unsigned Bytes	3		SSE2	SSE, MMX Extensions		
PAVGUSB	Packed Average Unsigned Bytes	3			3DNow!		
PAVGW	Packed Average Unsigned Words	3		SSE2	SSE, MMX Extensions		
PCMPEQB	Packed Compare Equal Bytes	3		SSE2	MMX		

1. Columns indicate the instruction subsets. Entries indicate the CPUID feature set(s) to which the instruction belongs.
2. Mnemonic is used for two different instructions. Assemblers can distinguish them by the number and type of operands.

Table D-1. Instruction Subsets and CPUID Feature Sets (continued)

Instruction			Instruction Subset and CPUID Feature Set(s) ¹				
Mnemonic	Description	CPL	General-Purpose	128-Bit Media	64-Bit Media	x87	System
PCMPEQD	Packed Compare Equal Doublewords	3		SSE2	MMX™		
PCMPEQW	Packed Compare Equal Words	3		SSE2	MMX		
PCMPGTB	Packed Compare Greater Than Signed Bytes	3		SSE2	MMX		
PCMPGTD	Packed Compare Greater Than Signed Doublewords	3		SSE2	MMX		
PCMPGTW	Packed Compare Greater Than Signed Words	3		SSE2	MMX		
PEXTRW	Packed Extract Word	3		SSE2	SSE, MMX Extensions		
PF2ID	Packed Floating-Point to Integer Doubleword Conversion	3			3DNow!		
PF2IW	Packed Floating-Point to Integer Word Conversion	3			3DNow! Extensions		
PFACC	Packed Floating-Point Accumulate	3			3DNow!		
PFADD	Packed Floating-Point Add	3			3DNow!		
PFCMPEQ	Packed Floating-Point Compare Equal	3			3DNow!		
PFCMPGE	Packed Floating-Point Compare Greater or Equal	3			3DNow!		

1. Columns indicate the instruction subsets. Entries indicate the CPUID feature set(s) to which the instruction belongs.
2. Mnemonic is used for two different instructions. Assemblers can distinguish them by the number and type of operands.

Table D-1. Instruction Subsets and CUID Feature Sets (continued)

Instruction			Instruction Subset and CUID Feature Set(s) ¹				
Mnemonic	Description	CPL	General-Purpose	128-Bit Media	64-Bit Media	x87	System
PFCMPGT	Packed Floating-Point Compare Greater Than	3			3DNow!™		
PFMAX	Packed Floating-Point Maximum	3			3DNow!		
PFCMIN	Packed Floating-Point Minimum	3			3DNow!		
PFCMUL	Packed Floating-Point Multiply	3			3DNow!		
PFCNACC	Packed Floating-Point Negative Accumulate	3			3DNow! Extensions		
PFCPNACC	Packed Floating-Point Positive-Negative Accumulate	3			3DNow! Extensions		
PFCRCP	Packed Floating-Point Reciprocal Approximation	3			3DNow!		
PFCRCPIT1	Packed Floating-Point Reciprocal, Iteration 1	3			3DNow!		
PFCRCPIT2	Packed Floating-Point Reciprocal or Reciprocal Square Root, Iteration 2	3			3DNow!		
PFCRSQIT1	Packed Floating-Point Reciprocal Square Root, Iteration 1	3			3DNow!		
PFCRSQRT	Packed Floating-Point Reciprocal Square Root Approximation	3			3DNow!		
PFCSUB	Packed Floating-Point Subtract	3			3DNow!		

1. Columns indicate the instruction subsets. Entries indicate the CUID feature set(s) to which the instruction belongs.
 2. Mnemonic is used for two different instructions. Assemblers can distinguish them by the number and type of operands.

Table D-1. Instruction Subsets and CUID Feature Sets (continued)

Instruction			Instruction Subset and CUID Feature Set(s) ¹				
Mnemonic	Description	CPL	General-Purpose	128-Bit Media	64-Bit Media	x87	System
PFSUBR	Packed Floating-Point Subtract Reverse	3			3DNow!™		
PI2FD	Packed Integer to Floating-Point Doubleword Conversion	3			3DNow!		
PI2FW	Packed Integer To Floating-Point Word Conversion	3			3DNow! Extensions		
PINSRW	Packed Insert Word	3		SSE2	SSE, MMX Extensions		
PMADDWD	Packed Multiply Words and Add Doublewords	3		SSE2	MMX™		
PMAXSW	Packed Maximum Signed Words	3		SSE2	SSE, MMX Extensions		
PMAXUB	Packed Maximum Unsigned Bytes	3		SSE2	SSE, MMX Extensions		
PMINSW	Packed Minimum Signed Words	3		SSE2	SSE, MMX Extensions		
PMINUB	Packed Minimum Unsigned Bytes	3		SSE2	SSE, MMX Extensions		
PMOVMSKB	Packed Move Mask Byte	3		SSE2	SSE, MMX Extensions		
PMULHRW	Packed Multiply High Rounded Word	3			3DNow!		
PMULHUW	Packed Multiply High Unsigned Word	3		SSE2	SSE, MMX Extensions		
PMULHW	Packed Multiply High Signed Word	3		SSE2	MMX		

1. Columns indicate the instruction subsets. Entries indicate the CUID feature set(s) to which the instruction belongs.

2. Mnemonic is used for two different instructions. Assemblers can distinguish them by the number and type of operands.

Table D-1. Instruction Subsets and CPUID Feature Sets (continued)

Instruction			Instruction Subset and CPUID Feature Set(s) ¹				
Mnemonic	Description	CPL	General-Purpose	128-Bit Media	64-Bit Media	x87	System
PMULLW	Packed Multiply Low Signed Word	3		SSE2	MMX™		
PMULUDQ	Packed Multiply Unsigned Doubleword and Store Quadword	3		SSE2	SSE2		
POP	Pop Stack	3	Basic				
POPA	Pop All to GPR Words	3	Basic				
POPAD	Pop All to GPR Doublewords	3	Basic				
POPF	Pop to FLAGS Word	3	Basic				
POPFD	Pop to EFLAGS Doubleword	3	Basic				
POPFQ	Pop to RFLAGS Quadword	3	Long Mode				
POR	Packed Logical Bitwise OR	3		SSE2	MMX		
PREFETCH	Prefetch L1 Data-Cache Line	3	3DNow!™, Long Mode				
PREFETCH $/level/$	Prefetch Data to Cache Level $/level/$	3	SSE, MMX Extensions				
PREFETCHW	Prefetch L1 Data-Cache Line for Write	3	3DNow!, Long Mode				
PSADBW	Packed Sum of Absolute Differences of Bytes into a Word	3		SSE2	SSE, MMX Extensions		
PSHUFD	Packed Shuffle Doublewords	3		SSE2			
PSHUFHW	Packed Shuffle High Words	3		SSE2			

1. Columns indicate the instruction subsets. Entries indicate the CPUID feature set(s) to which the instruction belongs.
2. Mnemonic is used for two different instructions. Assemblers can distinguish them by the number and type of operands.

Table D-1. Instruction Subsets and CPUID Feature Sets (continued)

Instruction			Instruction Subset and CPUID Feature Set(s) ¹				
Mnemonic	Description	CPL	General-Purpose	128-Bit Media	64-Bit Media	x87	System
PSHUFLW	Packed Shuffle Low Words	3		SSE2			
PSHUFW	Packed Shuffle Words	3			SSE, MMX Extensions		
PSLLD	Packed Shift Left Logical Doublewords	3		SSE2	MMX™		
PSLLDQ	Packed Shift Left Logical Double Quadword	3		SSE2			
PSLLQ	Packed Shift Left Logical Quadwords	3		SSE2	MMX		
PSLLW	Packed Shift Left Logical Words	3		SSE2	MMX		
PSRAD	Packed Shift Right Arithmetic Doublewords	3		SSE2	MMX		
PSRAW	Packed Shift Right Arithmetic Words	3		SSE2	MMX		
PSRLD	Packed Shift Right Logical Doublewords	3		SSE2	MMX		
PSRLDQ	Packed Shift Right Logical Double Quadword	3		SSE2			
PSRLQ	Packed Shift Right Logical Quadwords	3		SSE2	MMX		
PSRLW	Packed Shift Right Logical Words	3		SSE2	MMX		
PSUBB	Packed Subtract Bytes	3		SSE2	MMX		
PSUBD	Packed Subtract Doublewords	3		SSE2	MMX		

1. Columns indicate the instruction subsets. Entries indicate the CPUID feature set(s) to which the instruction belongs.
2. Mnemonic is used for two different instructions. Assemblers can distinguish them by the number and type of operands.

Table D-1. Instruction Subsets and CPUID Feature Sets (continued)

Instruction			Instruction Subset and CPUID Feature Set(s) ¹				
Mnemonic	Description	CPL	General-Purpose	128-Bit Media	64-Bit Media	x87	System
PSUBQ	Packed Subtract Quadword	3		SSE2	SSE2		
PSUBSB	Packed Subtract Signed With Saturation Bytes	3		SSE2	MMX™		
PSUBSW	Packed Subtract Signed with Saturation Words	3		SSE2	MMX		
PSUBUSB	Packed Subtract Unsigned and Saturate Bytes	3		SSE2	MMX		
PSUBUSW	Packed Subtract Unsigned and Saturate Words	3		SSE2	MMX		
PSUBW	Packed Subtract Words	3		SSE2	MMX		
PSWAPD	Packed Swap Doubleword	3			3DNow!™ Extensions		
PUNPCKHBW	Unpack and Interleave High Bytes	3		SSE2	MMX		
PUNPCKHDQ	Unpack and Interleave High Doublewords	3		SSE2	MMX		
PUNPCKHQDQ	Unpack and Interleave High Quadwords	3		SSE2			
PUNPCKHWD	Unpack and Interleave High Words	3		SSE2	MMX		
PUNPCKLBW	Unpack and Interleave Low Bytes	3		SSE2	MMX		
PUNPCKLDQ	Unpack and Interleave Low Doublewords	3		SSE2	MMX		
PUNPCKLQDQ	Unpack and Interleave Low Quadwords	3		SSE2			

1. Columns indicate the instruction subsets. Entries indicate the CPUID feature set(s) to which the instruction belongs.

2. Mnemonic is used for two different instructions. Assemblers can distinguish them by the number and type of operands.

Table D-1. Instruction Subsets and CUID Feature Sets (continued)

Instruction			Instruction Subset and CUID Feature Set(s) ¹				
Mnemonic	Description	CPL	General-Purpose	128-Bit Media	64-Bit Media	x87	System
PUNPCKLWD	Unpack and Interleave Low Words	3		SSE2	3DNow!™		
PUSH	Push onto Stack	3	Basic				
PUSHA	Push All GPR Words onto Stack	3	Basic				
PUSHAD	Push All GPR Doublewords onto Stack	3	Basic				
PUSHF	Push EFLAGS Word onto Stack	3	Basic				
PUSHFD	Push EFLAGS Doubleword onto Stack	3	Basic				
PUSHFQ	Push RFLAGS Quadword onto Stack	3	Long Mode				
PXOR	Packed Logical Bitwise Exclusive OR	3		SSE2	MMX		
RCL	Rotate Through Carry Left	3	Basic				
RCPPS	Reciprocal Packed Single-Precision Floating-Point	3		SSE			
RCPSS	Reciprocal Scalar Single-Precision Floating-Point	3		SSE			
RCR	Rotate Through Carry Right	3	Basic				
RDMSR	Read Model-Specific Register	0					RDMSR, WRMSR
RDPMC	Read Performance-Monitoring Counter	3					Basic

1. Columns indicate the instruction subsets. Entries indicate the CUID feature set(s) to which the instruction belongs.
2. Mnemonic is used for two different instructions. Assemblers can distinguish them by the number and type of operands.

Table D-1. Instruction Subsets and CUID Feature Sets (continued)

Instruction			Instruction Subset and CUID Feature Set(s) ¹				
Mnemonic	Description	CPL	General-Purpose	128-Bit Media	64-Bit Media	x87	System
RDTSC	Read Time-Stamp Counter	3					TSC
RET	Return from Call	3	Basic				
ROL	Rotate Left	3	Basic				
ROR	Rotate Right	3	Basic				
RSM	Resume from System Management Mode	3					Basic
RSQRTPS	Reciprocal Square Root Packed Single-Precision Floating-Point	3		SSE			
RSQRTSS	Reciprocal Square Root Scalar Single-Precision Floating-Point	3		SSE			
SAHF	Store AH into Flags	3	Basic				
SAL	Shift Arithmetic Left	3	Basic				
SAR	Shift Arithmetic Right	3	Basic				
SBB	Subtract with Borrow	3	Basic				
SCAS	Scan String	3	Basic				
SCASB	Scan String as Bytes	3	Basic				
SCASD	Scan String as Doubleword	3	Basic				
SCASQ	Scan String as Quadword	3	Long Mode				
SCASW	Scan String as Words	3	Basic				
SETcc	Set Byte if Condition	3	Basic				
SFENCE	Store Fence	3	SSE, MMX™ Extensions				

1. Columns indicate the instruction subsets. Entries indicate the CUID feature set(s) to which the instruction belongs.
2. Mnemonic is used for two different instructions. Assemblers can distinguish them by the number and type of operands.

Table D-1. Instruction Subsets and CUID Feature Sets (continued)

Instruction			Instruction Subset and CUID Feature Set(s) ¹				
Mnemonic	Description	CPL	General-Purpose	128-Bit Media	64-Bit Media	x87	System
SGDT	Store Global Descriptor Table Register	3					Basic
SHL	Shift Left	3	Basic				
SHLD	Shift Left Double	3	Basic				
SHR	Shift Right	3	Basic				
SHRD	Shift Right Double	3	Basic				
SHUFPD	Shuffle Packed Double-Precision Floating-Point	3		SSE2			
SHUFPS	Shuffle Packed Single-Precision Floating-Point	3		SSE			
SIDT	Store Interrupt Descriptor Table Register	3					Basic
SLDT	Store Local Descriptor Table Register	3					Basic
SMSW	Store Machine Status Word	3					Basic
SQRTPD	Square Root Packed Double-Precision Floating-Point	3		SSE2			
SQRTPS	Square Root Packed Single-Precision Floating-Point	3		SSE			
SQRTSD	Square Root Scalar Double-Precision Floating-Point	3		SSE2			
SQRTSS	Square Root Scalar Single-Precision Floating-Point	3		SSE			
STC	Set Carry Flag	3	Basic				

1. Columns indicate the instruction subsets. Entries indicate the CUID feature set(s) to which the instruction belongs.
2. Mnemonic is used for two different instructions. Assemblers can distinguish them by the number and type of operands.

Table D-1. Instruction Subsets and CPUID Feature Sets (continued)

Instruction			Instruction Subset and CPUID Feature Set(s) ¹				
Mnemonic	Description	CPL	General-Purpose	128-Bit Media	64-Bit Media	x87	System
STD	Set Direction Flag	3	Basic				
STI	Set Interrupt Flag	3					Basic
STMXCSR	Store MXCSR Control/Status Register	3		SSE			
STOS	Store String	3	Basic				
STOSB	Store String Bytes	3	Basic				
STOSD	Store String Doublewords	3	Basic				
STOSQ	Store String Quadwords	3	Long Mode				
STOSW	Store String Words	3	Basic				
STR	Store Task Register	3					Basic
SUB	Subtract	3	Basic				
SUBPD	Subtract Packed Double-Precision Floating-Point	3		SSE2			
SUBPS	Subtract Packed Single-Precision Floating-Point	3		SSE			
SUBSD	Subtract Scalar Double-Precision Floating-Point	3		SSE2			
SUBSS	Subtract Scalar Single-Precision Floating-Point	3		SSE			
SWAPGS	Swap GS Register with KernelGSbase MSR	0					Long Mode
SYSCALL	Fast System Call	3					SYSCALL, SYCRET
SYSENTER	System Call	3					SYSENTER, SYSEXIT

1. Columns indicate the instruction subsets. Entries indicate the CPUID feature set(s) to which the instruction belongs.
2. Mnemonic is used for two different instructions. Assemblers can distinguish them by the number and type of operands.

Table D-1. Instruction Subsets and CUID Feature Sets (continued)

Instruction			Instruction Subset and CUID Feature Set(s) ¹				
Mnemonic	Description	CPL	General-Purpose	128-Bit Media	64-Bit Media	x87	System
SYSEXIT	System Return	0					SYSENTER, SYSEXIT
SYSRET	Fast System Return	0					SYSCALL, SYSRET
TEST	Test Bits	3	Basic				
UCOMISD	Unordered Compare Scalar Double-Precision Floating-Point	3		SSE2			
UCOMISS	Unordered Compare Scalar Single-Precision Floating-Point	3		SSE			
UD2	Undefined Operation	3					Basic
UNPCKHPD	Unpack High Double-Precision Floating-Point	3		SSE2			
UNPCKHPS	Unpack High Single-Precision Floating-Point	3		SSE			
UNPCKLPD	Unpack Low Double-Precision Floating-Point	3		SSE2			
UNPCKLPS	Unpack Low Single-Precision Floating-Point	3		SSE			
VERR	Verify Segment for Reads	3					Basic
VERW	Verify Segment for Writes	3					Basic
WAIT	Wait for x87 Floating-Point Exceptions	3				X87	
WBINVD	Writeback and Invalidate Caches	0					Basic
WRMSR	Write to Model-Specific Register	0					RDMSR, WRMSR

1. Columns indicate the instruction subsets. Entries indicate the CUID feature set(s) to which the instruction belongs.

2. Mnemonic is used for two different instructions. Assemblers can distinguish them by the number and type of operands.

Table D-1. Instruction Subsets and CPUID Feature Sets (continued)

Instruction			Instruction Subset and CPUID Feature Set(s) ¹				
Mnemonic	Description	CPL	General-Purpose	128-Bit Media	64-Bit Media	x87	System
XADD	Exchange and Add	3	Basic				
XCHG	Exchange	3	Basic				
XLAT	Translate Table Index	3	Basic				
XLATB	Translate Table Index (No Operands)	3	Basic				
XOR	Exclusive OR	3	Basic				
XORPD	Logical Bitwise Exclusive OR Packed Double-Precision Floating-Point	3		SSE2			
XORPS	Logical Bitwise Exclusive OR Packed Single-Precision Floating-Point	3		SSE			

1. Columns indicate the instruction subsets. Entries indicate the CPUID feature set(s) to which the instruction belongs.
 2. Mnemonic is used for two different instructions. Assemblers can distinguish them by the number and type of operands.

Appendix E Instruction Effects on RFLAGS

The flags in the RFLAGS register are described in “Flags Register” in Volume 1 and “RFLAGS Register” in Volume 2. Table E-1 summarizes the effect that instructions have on these flags. The table includes all instructions that affect the flags. Instructions not shown have no effect on RFLAGS.

The following codes are used within the table:

- 0—The flag is always cleared to 0.
- 1—The flag is always set to 1.
- AH—The flag is loaded with value from AH register.
- Mod—The flag is modified, depending on the results of the instruction.
- Pop—The flag is loaded with value popped off of the stack.
- Tst—The flag is tested.
- U—The effect on the flag is undefined.
- Gray shaded cells indicate that the flag is not affected by the instruction.

Table E-1. Instruction Effects on RFLAGS

Instruction Mnemonic	RFLAGS Mnemonic and Bit Number																
	ID 21	VIP 20	VIF 19	AC 18	VM 17	RF 16	NT 14	IOPL 13-12	OF 11	DF 10	IF 9	TF 8	SF 7	ZF 6	AF 4	PF 2	CF 0
AAA AAS									U				U	U	Tst Mod	U	Mod
AAD AAM									U				Mod	Mod	U	Mod	U
ADC									Mod				Mod	Mod	Mod	Mod	Tst Mod
ADD									Mod				Mod	Mod	Mod	Mod	Mod
AND									0				Mod	Mod	U	Mod	0
ARPL														Mod			
BSF BSR									U				U	Mod	U	U	U

Table E-1. Instruction Effects on RFLAGS (continued)

Instruction Mnemonic	RFLAGS Mnemonic and Bit Number																
	ID 21	VIP 20	VIF 19	AC 18	VM 17	RF 16	NT 14	IOPL 13-12	OF 11	DF 10	IF 9	TF 8	SF 7	ZF 6	AF 4	PF 2	CF 0
BT BTC BTR BTS									U				U	U	U	U	Mod
CLC																	0
CLD									0								
CLI			Mod				TST			Mod							
CMC																	Mod
CMOV _{cc}								Tst					Tst	Tst		Tst	Tst
CMP								Mod					Mod	Mod	Mod	Mod	Mod
CMPS _x								Mod	Tst				Mod	Mod	Mod	Mod	Mod
CMPXCHG								Mod					Mod	Mod	Mod	Mod	Mod
CMPXCHG8B														Mod			
COMISD COMISS								0					0	Mod	0	Mod	Mod
DAA DAS								U					Mod	Mod	Tst Mod	Mod	Tst Mod
DEC								Mod					Mod	Mod	Mod	Mod	
DIV								U					U	U	U	U	U
FCMOV _{cc}														Tst		Tst	Tst
FCOMI FCOMIP FUCOMI FUCOMIP														Mod		Mod	Mod
IDIV								U					U	U	U	U	U
IMUL								Mod					U	U	U	U	Mod
INC								Mod					Mod	Mod	Mod	Mod	
IN							Tst										
INS _x							Tst		Tst								

Table E-1. Instruction Effects on RFLAGS (continued)

Instruction Mnemonic	RFLAGS Mnemonic and Bit Number																
	ID 21	VIP 20	VIF 19	AC 18	VM 17	RF 16	NT 14	IOPL 13-12	OF 11	DF 10	IF 9	TF 8	SF 7	ZF 6	AF 4	PF 2	CF 0
INT INT 3			Mod	Mod	Tst Mod	0	Mod	Tst			Mod	0					
INTO				Mod	Tst Mod	0	Mod	Tst	Tst		Mod	Mod					
IRET _x	Pop	Pop	Pop	Pop	Tst Pop	Pop	Tst Pop	Tst Pop	Pop	Pop	Pop	Pop	Pop	Pop	Pop	Pop	Pop
Jcc									Tst				Tst	Tst		Tst	Tst
LAR														Mod			
LODS _x									Tst								
LOOPE LOOPNE														Tst			
LSL														Mod			
MOVS _x									Tst								
MUL									Mod				U	U	U	U	Mod
NEG									Mod				Mod	Mod	Mod	Mod	Mod
OR									0				Mod	Mod	U	Mod	0
OUT								Tst									
OUTS _x								Tst		Tst							
POPF _x	Pop	Tst	Mod	Pop	Tst	0	Pop	Tst Pop	Pop	Pop	Pop	Pop	Pop	Pop	Pop	Pop	Pop
RCL 1									Mod								Tst Mod
RCL <i>count</i>									U								Tst Mod
RCR 1									Mod								Tst Mod
RCR <i>count</i>									U								Tst Mod
ROL 1									Mod								Mod

Table E-1. Instruction Effects on RFLAGS (continued)

Instruction Mnemonic	RFLAGS Mnemonic and Bit Number																
	ID 21	VIP 20	VIF 19	AC 18	VM 17	RF 16	NT 14	IOPL 13-12	OF 11	DF 10	IF 9	TF 8	SF 7	ZF 6	AF 4	PF 2	CF 0
ROL <i>count</i>									U								Mod
ROR 1									Mod								Mod
ROR <i>count</i>									U								Mod
RSM	Mod	Mod	Mod	Mod	Mod	Mod	Mod	Mod	Mod	Mod	Mod	Mod	Mod	Mod	Mod	Mod	Mod
SAHF													AH	AH	AH	AH	AH
SAL 1									Mod				Mod	Mod	U	Mod	Mod
SAL <i>count</i>									U				Mod	Mod	U	Mod	Mod
SAR 1									Mod				Mod	Mod	U	Mod	Mod
SAR <i>count</i>									U				Mod	Mod	U	Mod	Mod
SBB									Mod				Mod	Mod	Mod	Mod	Tst Mod
SCASx									Mod	Tst			Mod	Mod	Mod	Mod	Mod
SETcc									Tst				Tst	Tst		Tst	Tst
SHLD 1 SHRD 1									Mod				Mod	Mod	U	Mod	Mod
SHLD <i>count</i> SHRD <i>count</i>									U				Mod	Mod	U	Mod	Mod
SHR 1									Mod				Mod	Mod	U	Mod	Mod
SHR <i>count</i>									U				Mod	Mod	U	Mod	Mod
STC																	1
STD										1							
STI			Mod					Tst			Mod						
STOSx										Tst							
SUB									Mod				Mod	Mod	Mod	Mod	Mod
SYSCALL	Mod	Mod	Mod	Mod	0	0	Mod	Mod	Mod	Mod	Mod	Mod	Mod	Mod	Mod	Mod	Mod
SYSENTER					0	0					0						
SYSRET	Mod	Mod	Mod	Mod		0	Mod	Mod	Mod	Mod	Mod	Mod	Mod	Mod	Mod	Mod	Mod

Table E-1. Instruction Effects on RFLAGS (continued)

Instruction Mnemonic	RFLAGS Mnemonic and Bit Number																
	ID 21	VIP 20	VIF 19	AC 18	VM 17	RF 16	NT 14	IOPL 13-12	OF 11	DF 10	IF 9	TF 8	SF 7	ZF 6	AF 4	PF 2	CF 0
TEST									0				Mod	Mod	U	Mod	0
UCOMISD UCOMISS									0				0	Mod	0	Mod	Mod
VERR VERW														Mod			
XADD									Mod				Mod	Mod	Mod	Mod	Mod
XOR									0				Mod	Mod	U	Mod	0

Index

Numerics

16-bit mode.....	xvii
32-bit mode.....	xvii
64-bit mode.....	xvii

A

AAA.....	61
AAD.....	62
AAM.....	63
AAS.....	64
ADC.....	65
ADD.....	67
address size prefix.....	6, 25
addressing	
byte registers.....	17
effective address.....	397, 400, 401, 403
PC-relative.....	23
RIP-relative.....	xxiii, 23
AND.....	69
ARPL.....	294

B

base field.....	402, 403
biased exponent.....	xvii
BOUND.....	72
BSF.....	74
BSR.....	76
BSWAP.....	78
BT.....	79
BTC.....	81
BTR.....	83
BTS.....	85
byte order of instructions.....	1
byte register addressing.....	17

C

cache configuration information.....	126
CALL.....	15
far call.....	89
near call.....	87
CBW.....	96
CDQ.....	97
CDQE.....	96
CLC.....	98
CLD.....	99
CLFLUSH.....	100
CLI.....	296
CLTS.....	298
CMC.....	102
CMOVcc.....	103, 380

CMP.....	107
CMPSx.....	110
CMPXCHG.....	113
CMPXCHG8B.....	115
commit.....	xviii
compatibility mode.....	xviii
condition codes	
rFLAGS.....	380, 395
count.....	406
CPUID.....	117
extended functions.....	117
feature sets.....	445
standard functions.....	117
CPUID instruction	
cache information.....	126
long-mode address sizes.....	130
testing for.....	117
CQD.....	97
CWD.....	97
CWDE.....	96

D

DAA.....	132
DAS.....	133
data types	
128-bit media.....	36
64-bit media.....	38
general-purpose.....	32
x87.....	40
DEC.....	17, 134, 439
direct referencing.....	xviii
displacements.....	xviii, 22, 406
DIV.....	136
double quadword.....	xviii
doubleword.....	xviii

E

eAX–eSP register.....	xxiv
effective address.....	397, 400, 401, 403
effective address size.....	xix
effective operand size.....	xix
eFLAGS register.....	xxv
eIP register.....	xxv
element.....	xix
endian order.....	xxvii, 1
ENTER.....	15, 138
exceptions.....	xix, 41
exponent.....	xvii

F			
FCMOVcc.....	395	far jump	169
flush	xix	near jump.....	167
G		JRCXZ.....	165
general-purpose registers	30	JrCXZ	15
H		L	
HLT	299	LAHF.....	174
I		LAR	311
IDIV	140	LDS.....	175
IGN.....	xx	LEA.....	178
immediate operands.....	23, 406	LEAVE.....	15, 180
IMUL.....	142	legacy mode	xx
IN.....	145	legacy x86	xx
INC.....	17, 147, 439	LES	175
index field	403	LFENCE	182, 384
indirect	xx	LFS	175
instructions		LGDT.....	15, 314
128-bit media.....	447	LGS.....	175
3DNow!™.....	446	LIDT	15, 316
64-bit media.....	447	LLDT	15, 318
byte order	1	LMSW.....	320
effects on rFLAGS	481	LOCK prefix	10
formats.....	1	LODSx.....	183
general-purpose	59, 447	long mode.....	xx
invalid in 64-bit mode.....	436	long-mode address sizes	130
invalid in long mode.....	437	LOOP.....	15
MMX™.....	445	LOOPcc	15
opcodes	20, 369	LOOPx.....	185
origins	443	LSB	xxi
reassigned in 64-bit mode	437	lsb	xxi
SSE.....	446	LSL	321
SSE-2.....	446	LSS.....	175
subsets	27, 443	LTR	15, 323
system	293, 447	M	
x87	445, 447	mask	xxi
INSx	149	MBZ	xxi
INT	152	MFENCE	187, 384
INT 3	300	mod field.....	400
interrupt vectors.....	41	mode-register-memory (ModRM)	395
INTO.....	160	modes	441
INVD.....	303	16-bit.....	xvii
INVLPG	304, 384	32-bit.....	xvii
IRET.....	305	64-bit.....	xvii, 441
IRETD.....	305	compatibility	xviii, 441
IRETQ.....	305	legacy.....	xx
J		long.....	xx, 441
Jcc	15, 161, 380	protected.....	xxii
JCXZ	165	real.....	xxii
JECXZ	165	virtual-8086.....	xxiv
JMP	15	ModRM.....	395
		ModRM byte	19, 20, 24, 381, 386, 395
		moffset	xxi

MOV	188	encodings	395
MOV CR(n).....	15	immediate	23, 406
MOV DR(n).....	15	size	5, 405, 406, 437
MOV(CRn).....	325	OR.....	212
MOV(DRn).....	327	OUT	215
MOVD	192	OUTSx.....	217
MOVMSKPD.....	195	overflow.....	xxii
MOVMSKPS	197	P	
MOVNTL.....	199	packed	xxii
MOVSX	203	PC-relative addressing.....	23
MOVSx.....	201	POP.....	219
MOVSXD	204	POP FS	15
MOVZX.....	205	POP GS	15
MSB.....	xxi	POP reg	15
msb.....	xxi	POP reg/mem.....	15
MSR	xxv	POPAX	222
MUL	206	POPFQ.....	15
N		POPFx	223
NEG.....	208	PREFETCHlevel	228
NOP.....	210, 439	PREFETCHx.....	226
NOT	211	prefixes	
notation	43, 369	address size	6, 25
O		LOCK.....	10
octword	xxii	operand size	5
offset	xxii, 22	repeat	10
opcodes	20	REX	14, 24
3DNow!™	384	segment	9
group 1	382	processor feature identification	
group 10.....	383	(rFLAGS.ID).....	117
group 11.....	383	processor name.....	125
group 12.....	383	processor signature	123
group 13.....	383	processor vendor	118, 123
group 14.....	383	processor version.....	118
group 15.....	383	protected mode	xxii
group 16.....	383	PUSH.....	230
group 1a.....	382	PUSH FS	15
group 2.....	382	PUSH GS.....	15
group 3.....	382	PUSH imm32	15
group 4.....	382	PUSH imm8	15
group 5.....	382	PUSH reg	15
group 6.....	382	PUSH reg/mem.....	15
group 7.....	382	PUSHAX.....	232
group 8.....	382	PUSHFQ.....	15
group 9.....	383	PUSHFx	233
group P.....	383	Q	
groups	381	quadword	xxii
ModRM byte.....	381	R	
one-byte opcode map.....	371	r/m field.....	381, 384
two-byte opcode map.....	374	r8–r15	xxv
x87 opcode map	386	rAX–rSP	xxvi
operands			

RAZ	xxii	SCASx	261
RCL	235	segment prefixes	9, 440
RCR	238	segment registers	32
RDMSR	329	set	xxiii
RDPMC	330	SETcc	263, 380
RDTSC	331	SFENCE	266, 384
real address mode. See real mode		SGDT	334
real mode	xxii	shift count	406
reg field	381, 396, 399, 400	SHL	267
registers		SHLD	268
eAX–eSP	xxiv	SHR	270
eFLAGS	xxv	SHRD	272
eIP	xxv	SIB	395
encodings	17	SIB byte	19, 21, 24, 401
general-purpose	30	SIDT	336
MMX	38	SLDT	338
r8–r15	xxv	SMSW	340
rAX–rSP	xxvi	SSE	xxiii
rFLAGS	xxvi, 380, 395, 481	SSE-2	xxiii
rIP	xxvi	STC	274
segment	32	STD	275
system	33	STI	341
x87	40	sticky bits	xxiii
XMM	35	STOSx	276
relative	xxii	STR	343
REPx prefixes	10	SUB	278
RET		SWAPGS	345, 384
far return	243	syntax	43
near return	241	SYSCALL	347
RET (Near)	15	SYSENTER	352
revision history	xiii	SYSEXIT	354
REX prefixes	14, 24, 395	SYSRET	356
REX.B bit	17, 47, 400, 402	system data structures	34
REX.R bit	16, 399	T	
REX.W bit	16	TEST	281
REX.X bit	16	TSS	xxiii
rFLAGS conditions codes	380, 395	U	
rFLAGS register	xxvi, 481	UD2	360
rIP register	xxvi	underflow	xxiii
RIP-relative addressing	xxiii, 23	V	
ROL	247	vector	xxiv
ROR	249	VERR	361
rotate count	406	VERW	363
RSM	332	virtual-8086 mode	xxiv
S		W	
SAHF	251	WBINVD	365
SAL	252	WRMSR	366
SAR	255	X	
SBB	258	XADD	283
scale field	403		
scale-index-base (SIB)	395		

XCHG.....	285
XLATx.....	287
XOR	289
Z	
zero-extension	406

