

Notice

The information in this guide is subject to change without notice.

COMPAQ COMPUTER CORPORATION SHALL NOT BE LIABLE FOR TECHNICAL OR EDITORIAL ERRORS OR OMISSIONS CONTAINED HEREIN; NOR FOR INCIDENTAL OR CONSEQUENTIAL DAMAGES RESULTING FROM THE FURNISHING, PERFORMANCE, OR USE OF THIS MATERIAL.

This guide contains information protected by copyright. No part of this guide may be photocopied or reproduced in any form without prior written consent from Compaq Computer Corporation.

© 1998 Compaq Computer Corporation.
All rights reserved. Printed in U.S.A.

Compaq, Armada, and LTE are registered in the U.S. Patent and Trademark Office.

Microsoft, MS-DOS, and Windows are registered trademarks of Microsoft Corporation.

The software described in this guide is furnished under a license agreement or nondisclosure agreement. The software may be used or copied only in accordance with the terms of the agreement.

Product names mentioned herein may be trademarks and/or registered trademarks of their respective companies.

REFERENCE GUIDE

Armada 7800 Family of Personal Computers

First Edition, March 1998
Part Number 314932-001

Compaq Computer Corporation

CONTENTS

preface

USING THIS GUIDE

chapter 1

GETTING STARTED

Unpacking the Computer	1-1
Taking the Battery Pack Out of Ship Mode.....	1-3
Setting Up the Computer.....	1-5
Charging the Battery Pack for the First Time	1-5
Connecting the Power Cord.....	1-6
Opening the Computer.....	1-7
Adjusting the Keyboard.....	1-7
Turning On the Computer.....	1-8
Setting Up the Software	1-9
Operating the Computer During Setup.....	1-9
Choosing a Language.....	1-9
Removing the Operating System.....	1-10
Restoring Your Operating System and Software Preinstalled by Compaq.....	1-10
Completing Setup.....	1-11
Registering the Computer.....	1-11
Locating Online Resources.....	1-11

chapter 2

TAKING A LOOK AT THE COMPUTER

Front Components.....	2-1
Left Side Components.....	2-3
Rear Components	2-4
Right Side Components.....	2-6
Top Components	2-7
Bottom Components.....	2-10
Display Controls.....	2-11
MPEG Overview	2-12
USB Overview	2-12
Ordering Preinstalled Software.....	2-13

chapter 3

USING THE KEYBOARD AND POINTING DEVICE

Using the Pointing Device	3-1
Keyboard Components	3-3
Hotkey Quick Reference.....	3-4
Moving the Hotkey Popup Window Location	3-5
Switching Displays.....	3-6
Adjusting System Warning Beep Volume	3-7
Initiating QuickLock/QuickBlank.....	3-8
Selecting a Power Management Level.....	3-9
Accessing the Battery Gauge	3-10
Adjusting the Brightness Control.....	3-11
Accessing the BIOS Version Number.....	3-12
Accessing the Embedded Numeric Keypad.....	3-13
Stretching Text	3-14
Programmable Keys Overview.....	3-15
Assigning or Reassigning Programmable Keys.....	3-16
Unassigning Programmable Keys	3-17
Adding Schemes.....	3-17
Removing Schemes	3-18
Showing the Key Assignments in the System Tray.....	3-18

chapter 4

USING POWER AND POWER MANAGEMENT

Leaving On the Computer	4-1
Turning Off the Computer	4-1
Power Management Overview	4-2
Accessing Power Management.....	4-2
Setting the Power Management Level.....	4-3
Power Management Levels	4-3
Setting the Power Management Level With Power Properties.....	4-4
Setting the Power Management Level With Computer Setup	4-4
Suspend Overview	4-5
Initiating Suspend.....	4-5
Exiting Suspend.....	4-7

Hibernation Overview	4-8
Initiating Hibernation.....	4-9
Enabling/Disabling Hibernation	4-10
Exiting Hibernation.....	4-10
Timeout Overview.....	4-11
Setting the Screen Save Timeout.....	4-11
AC Energy Saver Overview	4-12
Enabling/Disabling PC Card Slots.....	4-12

chapter 5

USING BATTERY PACKS

Battery Components.....	5-1
Using a New Battery Pack	5-2
Charging Battery Packs.....	5-2
Charging Battery Packs in the Computer	5-2
Charging Battery Packs Outside of Normal Operating Conditions.....	5-3
Ensuring Battery Gauge Accuracy.....	5-3
Identifying a Low Battery Condition.....	5-4
Resolving a Low Battery Condition	5-5
Resolving a Low Battery Condition by Connecting to an Electrical Outlet	5-5
Resolving a Low Battery Condition by Connecting to the Automobile Adapter	5-6
Resolving a Low Battery Condition by Replacing the Battery Pack	5-8
Resolving a Low Battery Condition With No Power Sources Available	5-8
Replacing Battery Packs.....	5-9
Removing the Battery Pack from the Battery Bay	5-9
Inserting the Battery Pack in the Battery Bay	5-11
Removing the Battery Pack from the MultiBay	5-12
Inserting the Battery Pack in the MultiBay	5-14
Storing Battery Packs	5-15
Maximizing Battery Pack Life	5-16
Beeps When Display is Closed and Computer is Turned On	5-16
Recycling Used Battery Packs	5-17

chapter 6

WORKING WITH REMOVABLE DRIVES

Removable Drive Bays	6-1
Caring for Removable Drives	6-2
MultiBay Weight Saver	6-3
Hard Drives	6-4
Removing a Hard Drive from the Hard Drive Bay	6-4
Inserting a Hard Drive into the Hard Drive Bay	6-6
Removing a Hard Drive from the MultiBay	6-7
Inserting a Hard Drive into the MultiBay	6-9
CD-ROM Drives	6-10
Removing a CD-ROM Drive from the MultiBay	6-10
Inserting a CD-ROM Drive into the MultiBay	6-12
Working with Compact Discs	6-13
Diskette Drives	6-17
Removing a Diskette Drive from the MultiBay	6-17
Inserting a Diskette Drive into the MultiBay	6-19
Working with Diskettes	6-20

chapter 7

USING THE INTERNAL MODEM

Modem Basics	7-1
Understanding How a Modem Works	7-1
Understanding Modem Software	7-2
Editing and Executing a Command	7-2
Connecting the Modem	7-3
Connecting the Modem in North America, Latin America, Japan, or Hong Kong	7-3
Connecting the Modem in Europe, the Middle East, or Africa	7-4
Using a Country-Specific Modem Cable	7-5
Setting Modem Defaults	7-8
Setting S Register Default Values	7-9
Modifying an S Register	7-9
Reading an S Register	7-9

Using Online Mode	7-10
Escaping from an Online Session to the Command Mode.....	7-10
Creating a Command Mode Shortcut	7-11
Creating a Command Mode Icon.....	7-12
Using the Modem with a Cellular Phone (United States Only).....	7-13
Choosing Cellular Direct Components.....	7-13
Connecting the Modem to a Cellular Phone.....	7-14
Registering the Phone with the Modem	7-15
Using PIN Dialing	7-16
PIN Dialing When Using a Stored Dial Suffix	7-16
Modem Cellular Basics.....	7-17
Disabling Cellular Phone Recognition	7-17
Checking the Phone and Modem Connection	7-18
Checking Signal Strength	7-18
Using the &J Command (Telephone Interface Control)	7-19
Power Management for a Cellular Connection	7-19
How the Environment Affects Cellular Performance	7-20
Using Windows or DSVD Application Software	7-23
Using the Command Mode of Windows HyperTerminal	7-23
Starting with a Voice Connection.....	7-24
Starting with a Data Connection.....	7-25
Changing from a DSVD Connection to a Data Connection.....	7-26
Changing from a DSVD Connection to a Speakerphone Connection	7-26

chapter 8

USING THE INFRARED PORT

Infrared Connection Overview.....	8-1
Establishing an Infrared Link.....	8-2

chapter 9

USING PC CARDS

Types of PC Cards.....	9-1
Inserting a PC Card	9-3
Removing a PC Card.....	9-5
Stopping a PC Card.....	9-6
PC Card Device Drivers.....	9-7
Zoomed Video.....	9-7

chapter 10

USING AUDIO FEATURES

Introducing the Audio Components	10-1
Using Internal and External Microphones.....	10-2
Using Internal and External Speakers	10-4
Internal Speakers	10-4
External Speakers	10-4
Identifying Audio Connections	10-6
Controlling Audio Volume	10-8

chapter 11

UPGRADING RAM MEMORY

Increasing RAM.....	11-1
Obtaining an Optional Memory Expansion Board.....	11-2
Removing a Memory Expansion Slot Cover.....	11-3
Removing a Memory Expansion Board	11-5
Inserting a Memory Expansion Board.....	11-6
Replacing the Memory Expansion Slot Cover	11-7

chapter 12

MAINTENANCE AND TRAVEL GUIDELINES

Caring for the Computer	12-1
Replacing the Pointing Device Rubber Cap.....	12-2
Cleaning the Screen	12-3
Operating Temperatures	12-3
Traveling With the Computer.....	12-4
Shipping the Computer	12-5

chapter 13

SECURITY FEATURES

Types of Security	13-1
Power-On Password.....	13-3
Setting the Power-On Password Using Windows 95.....	13-3
Setting the Power-On Password Using Windows NT	13-4
Entering the Power-On Password	13-4
Changing the Power-On Password.....	13-5
Deleting the Power-On Password	13-5
If You Forget Your Password	13-5

Setup Password	13-6
Setting the Setup Password.....	13-6
Entering the Setup Password	13-7
Changing the Setup Password	13-7
Deleting the Setup Password	13-8
Change/Delete Password Symbols.....	13-9
Using the Quick Controls.....	13-10
Enabling and Disabling QuickLock/QuickBlank }	
Using Windows 95.....	13-10
Enabling and Disabling QuickLock/QuickBlank	
Using Windows NT	13-11
DriveLock Overview.....	13-11
User and Master Passwords Overview	13-12
Establishing DriveLock Protection.....	13-13
Changing the User Password	13-14
Removing DriveLock Protection.....	13-15
Changing the Master Password	13-16
Disabling and Enabling Devices	13-17
Using the Cable Lock.....	13-18

chapter 14

INTELLIGENT MANAGEABILITY

Intelligent Manageability Overview	14-1
Asset Management Overview	14-2
Changing the Asset Tag Number.....	14-2
Fault Management Overview	14-3
Fault Management Alerts Overview.....	14-3
Security Management Overview.....	14-3
Configuration Management Overview	14-4

chapter 15

COMPUTER SETUP AND DIAGNOSTICS UTILITIES

Computer Setup Overview	15-1
Running Computer Setup	15-2
Exiting Computer Setup	15-3

Using Compaq Utilities	15-3
Running Computer Checkup (TEST).....	15-4
Running View System Information (INSPECT)	15-5
Running Compaq Diagnostics.....	15-5
Boot Sequencing	15-6
Factory Default Settings	15-7

chapter 16

TROUBLESHOOTING

Checklist for Solving Problems	16-1
Solving Audio Problems.....	16-2
Computer does not beep after the Power-On	
Self-Test (POST)	16-2
Internal speaker does not produce sound when an external	
audio source is connected to the stereo line-in jack.....	16-2
External microphone does not work	16-3
No sound from game program	16-3
No sound from headphones.....	16-4
Volume too low or too loud	16-5
Solving Battery Pack/Battery Gauge Problems.....	16-6
Computer is beeping and battery power light is blinking.....	16-6
Computer battery power light blinks to indicate low battery	
condition, but computer does not beep	16-6
Battery pack will not charge.....	16-6
Computer shut down and memory was lost when replacing	
the battery pack.....	16-7
Every time computer is turned on, date and time	
must be set	16-8
Battery charge does not last very long	16-8
Solving Compact Disc/CD-ROM Drive Problems.....	16-10
CD-ROM drive cannot read a compact disc	16-10
CD-ROM drive is not recognized by the computer	16-10
Solving Diskette/Diskette Drive Problems.....	16-11
Diskette drive cannot read a diskette.....	16-11
Diskette drive cannot write to a diskette	16-12
Solving Hard Drive Problems.....	16-14
Accessing information on the hard drive is much slower	
than usual.....	16-14
Hard drive error occurs.....	16-14
Hard drive does not work	16-15
Errors occur after starting from an additional hard drive	16-15

Solving Infrared Problems	16-16
Cannot communicate with another computer.....	16-16
Cannot transmit data	16-17
Infrared port does not work	16-19
Solving Keyboard/Numeric Keypad Problems.....	16-20
Screen is blank and keyboard is working	16-20
Embedded numeric keypad on computer keyboard is disabled.....	16-20
Solving PC Card Problems.....	16-21
Computer does not beep when a PC Card is inserted.....	16-21
Computer beeps only once when a PC Card is inserted.....	16-22
PC Card drivers fail with error messages during system restart.....	16-22
Network PC Card does not work.....	16-23
Storage PC Card does not work.....	16-23
Solving Power Problems	16-25
Computer will not turn on.....	16-25
Computer turned off while it was left unattended	16-26
Solving Screen Problems	16-27
Characters on computer display are dim	16-27
Screen is blank	16-27
Computer screen is blank and external monitor displays information.....	16-29
Solving USB Problems	16-30
External device connected to a USB connector does not work	16-30
External device connected to USB connector does not work during startup (before Windows 95 loads)	16-30
External devices in lower tiers do not work	16-31

Solving Modem Problems	16-32
Modem loses connection	16-32
Characters are garbled/transfer rates are slow.....	16-32
Phone line noise causes a disconnection.....	16-33
No dial tone	16-33
Cellular connection doesn't work (United States only).....	16-34
Ten digit dialing does not work correctly under Windows 95.....	16-34
Modem cable disables/interferes with other telephony devices (Germany, Austria, and Switzerland only)	16-35
Modem does not dial correctly under Windows 95 (Switzerland and Germany only)	16-36
Modem does not identify modem cable correctly.....	16-37

appendix A

COMPAQ CUSTOMER SUPPORT

appendix B

REGULATORY NOTICES

appendix C

ELECTROSTATIC DISCHARGE

appendix D

SPECIFICATIONS

USING THIS GUIDE

Some or all of the following format conventions are used in this guide to distinguish elements of text:

- Names of keys are shown in bold type as they appear on the keyboard, for example, **Ctrl, Backspace, Tab**.
- Keys that you should press at the same time are represented by the key names and the plus (+) symbol, for example, **Ctrl+Alt+Delete**.
- Commands are presented in lowercase, bold type as shown here: **install** or **a:\install**.
- An arrow symbol is used to separate icons or menu options that you should select in succession; for example, click the Start button → Settings → Control Panel.
- When you need to type information without pressing the **Enter** key, you are directed to “type” the information.
- When you need to type information *and* press the **Enter** key, you are directed to “enter” the information.

NOTE: Text set off in this manner presents commentary, sidelights, or interesting points of information.

IMPORTANT: Text set off in this manner presents clarifying information or specific instructions.



WARNING: Text set off in this manner indicates that failure to follow directions could result in bodily harm or loss of life.



CAUTION: Text set off in this manner indicates that failure to follow directions could result in damage to equipment or loss of information.

chapter 1

GETTING STARTED

Unpacking the Computer

You should have the following items in the packing box:

- ❶ Computer
- ❷ Diskette drive
- ❸ MultiBay weight saver
- ❹ Hard drive
- ❺ Lithium ion battery pack
- ❻ CD-ROM drive
- ❼ Hard drive carrying case
- ❽ Power cord
- ❾ Modem cable
- ❿ MultiBay device carrying case
- ⓫ Bag containing two spare pointing device caps
- ⓬ Bag containing:
 - Two dual-bay security screws (double tab)
 - Two single-bay security screws (single tab)
 - Two memory expansion slot cover security screws
 - Torx T-10 screwdriver to use with security screws
- ⓭ 3-to-2-prong power plug adapter (Japan only)

Taking the Battery Pack Out of Ship Mode

Before you set up the computer, you must take the battery pack out of ship mode so that it can be charged.

Take the battery pack out of ship mode by removing and reinserting the battery pack:

- 1 Tilt the computer **1** to access the battery release latch.
- 2 Slide the battery release latch **2** right while pulling on the battery pack from the recess beneath the battery bay.

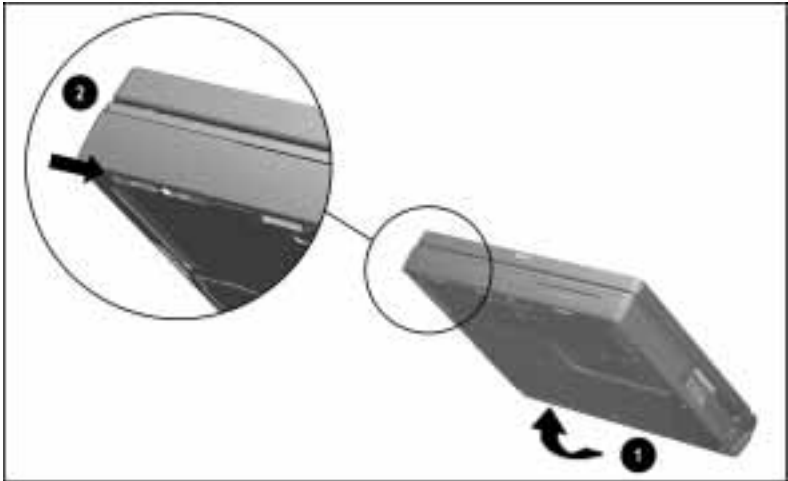

3 Pull the battery pack out of the battery bay.



4 Remove the sticker from the battery pack.

5 Reinsert the battery pack into the battery bay until it clicks into place.



NOTE: Ship mode does not apply to traveling with or shipping the computer.

Setting Up the Computer

Before you set up the computer for the first time, ensure that

- The computer is using AC power.
- The computer is not docked in a docking station.

Charging the Battery Pack for the First Time

The battery pack begins to charge when the computer is connected to external power.

Although a new battery pack can be used to power the computer after receiving a partial charge, Compaq recommends that a new battery pack be allowed to fully charge before the computer is disconnected from external power or before the battery pack is removed from the computer.

IMPORTANT: The battery charge level lights on a new battery pack accurately display the percent of a full charge remaining in the battery pack only after the battery has been fully charged.

A new battery pack fully charges in approximately

- 2.5 hours when the computer is connected to external power and not being used.
- 4 hours when the computer is connected to external power and being used.

Connecting the Power Cord

- 1 Place the computer on a flat surface near an electrical outlet.
- 2 Plug the power cord into the power connector on the rear panel of the computer ❶, then into the electrical outlet ❷.



NOTE: In Japan, you must first plug the power cord into the 3-to-2-prong plug adapter included with the computer. Ensure that the ground wire is connected to a safe earth ground, then plug the 3-to-2-prong plug adapter into the electrical outlet.



WARNING: To reduce the risk of personal injury, electric shock, fire, or damage to the equipment:

- Do not disable the power cord grounding plug. The grounding plug is an important safety feature.
- Plug the equipment into a grounded (earthed) electrical outlet that is easily accessible at all times.
- Disconnect power from the equipment by unplugging the power cord from the electrical outlet.
- Do not place anything on power cords or cables. Arrange them so that no one may accidentally step on or trip over them. Do not pull on a cord or cable. When unplugging from the electrical outlet, grasp the cord by the plug.

Opening the Computer

Slide forward the display release latch ❶ on the front of the display, then raise the display ❷ to a comfortable viewing angle.

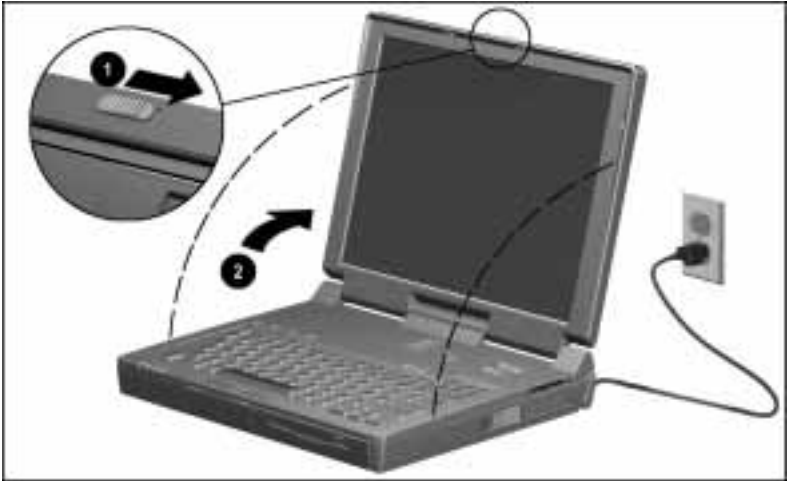

Adjusting the Keyboard

To elevate the back of the keyboard, swivel the tilt feet back and down.



Turning On the Computer

Slide the power switch and release it. Whenever the computer is turned on, the power/suspend light turns on to indicate that power is turned on.

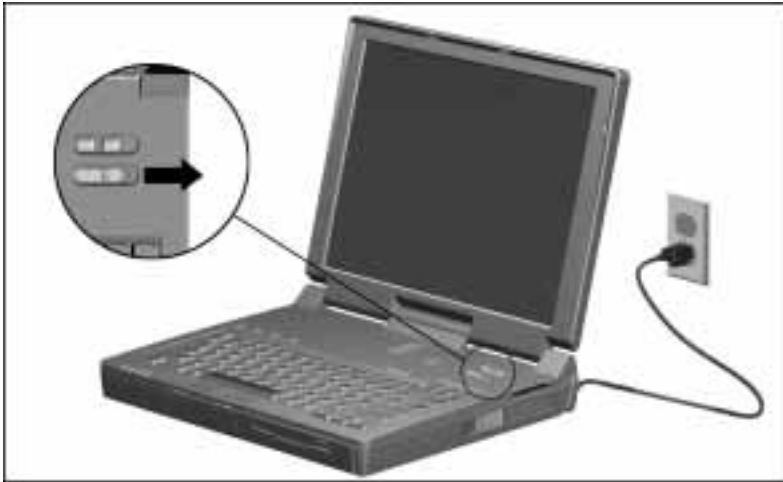

NOTE: To restore the screen if it is cleared by the screen saver during a period of keyboard and mouse inactivity, press the **Shift** key. After the computer has been set up for the first time, any key can be used to restore the screen cleared by the screen saver.

Setting Up the Software

When you begin software setup, online instructions guide you through the setup process.

IMPORTANT: After you begin software setup, you must complete the entire process, which may require up to 20 minutes. Make sure the computer is plugged in for this process to ensure that software setup is uninterrupted.



CAUTION: To prevent file corruption and ensure the correct software drivers are installed:

- Do not dock the computer in a docking station.
 - Do not turn off or unplug the computer or remove a drive during software setup.
-

Operating the Computer During Setup

- To move around the screen while making selections and entering information:
 - press the **Tab** key,
 - press the cursor (arrow) keys, or
 - use the pointing device built into the computer keyboard.
- To save your selections, press the **Enter** key or press one of the mouse buttons on the computer keyboard.
- To restore the screen if it is cleared by the screen saver during a period of keyboard and mouse inactivity, press the **Shift** key.

For more information about using the built-in pointing device and mouse buttons, refer to Chapter 3, “Using the Keyboard and Pointing Device.”

Choosing a Language

If you are prompted to select your language, choose carefully.

IMPORTANT: The languages that you do **not** choose will be deleted from the computer and cannot be recovered.

Removing the Operating System

Either Microsoft Windows 95 or Microsoft Windows NT Workstation is preinstalled on the computer.

Compaq has enhanced the preinstalled versions of these operating systems to provide you with additional software features and increased computer functionality.

Before deleting the operating system preinstalled on the computer, please read the following Caution:



CAUTION:

- Replacing the preinstalled Windows 95 or Windows NT operating system with a retail version will result in the loss of all enhancements added by Compaq such as PC Card support and enhanced power management.
 - Installing the retail version of Windows NT may result in system lockups and loss of unsaved information.
 - Most preinstalled reference files, such as Help files, are available only through the Windows 95 or Windows NT interface. If Windows 95 or Windows NT is removed from the computer, these reference files will become unavailable.
 - Complete USB support is available only through the Windows 95 or Windows NT interface. If the operating system preinstalled on the computer is replaced by an operating system other than Windows 95 or Windows NT, USB support will be decreased.
-

Restoring Your Operating System and Software Preinstalled by Compaq

Your computer comes preinstalled with either Windows 95 or Windows NT Workstation 4.0. In addition to the operating system, Compaq installs other software to provide additional functionality or enhancements. If it is necessary to reinstall the operating system and you do not want to lose these enhancements, it will also be necessary to reinstall all Compaq software for your computer. Contact Compaq customer support for more information on this additional software and the various tools available to help reinstall.

Completing Setup

Before beginning your work, Compaq recommends that you:

- Register the computer.
- Locate Compaq's online resources, such as the online *Reference Guide* and the online *Options Catalog*.

Registering the Computer

Be sure to register the computer according to the instructions on the *Owner Registration Card* included with the computer.

Locating Online Resources

For your convenience while traveling, all information contained in this *Reference Guide* and in the printed Accessories flier included with the computer is available online.

- To access the *Reference Guide* online:
 - Click Start → Compaq Information Center → Reference Guide
 - or
 - Click Start → Help → Contents → Reference Guide
- To access the Options Catalog online:
 - Click Start → Compaq Information Center → Options Catalog

To access information on the Internet, go to www.compaq.com.



chapter 2

TAKING A LOOK AT THE COMPUTER

Front Components

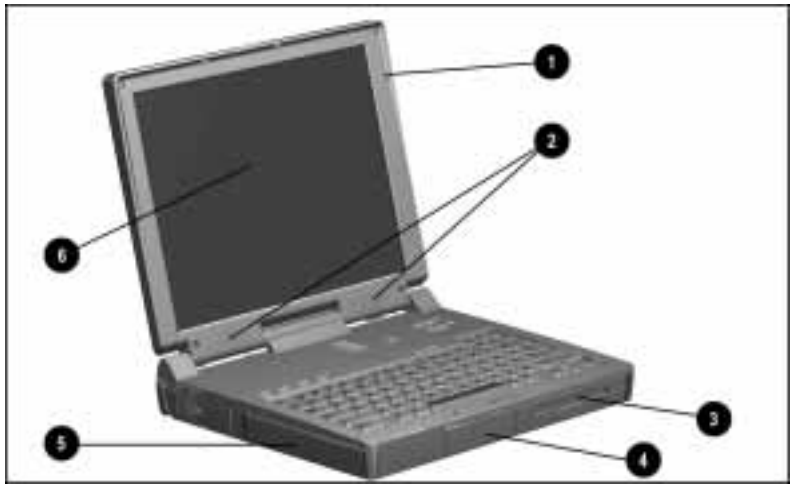

Front Components

Component	Function
① Mono microphone	Built-in monophonic microphone for the multimedia sound system.
② Stereo speakers	Built-in speakers for computer sounds and the multimedia sound system.

Continued

Front Components *Continued*

Component	Function
③ MultiBay	A multifunction device compartment in the computer base that supports a removable hard drive, diskette drive, or CD-ROM drive, or an extra battery pack.
④ Hard drive bay	Holds the removable hard drive shipped with the computer.
⑤ Battery bay	Holds the main battery pack in the computer.
⑥ Display	The monitor that comes attached to the computer.

Left Side Components

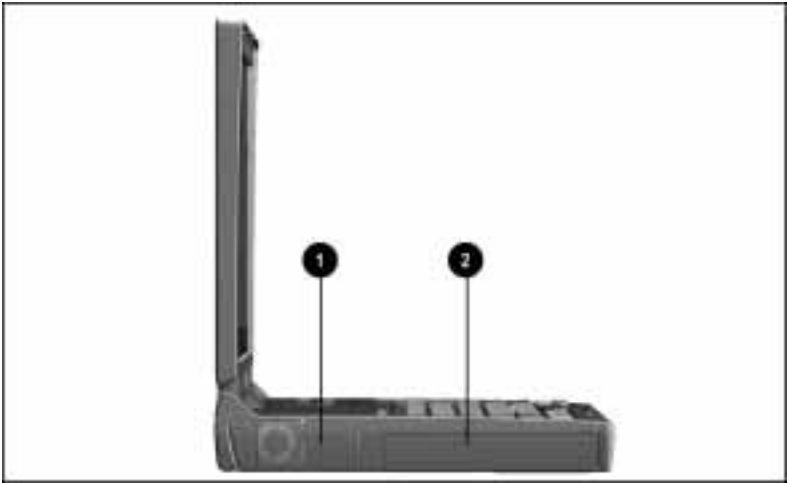

Left Side Components

Component	Function
❶ Fan	Airflow exhaust used to keep the internal components of the computer cool. The fan will automatically run when needed.
❷ Battery bay	Holds the main battery pack in the computer.

Rear Components

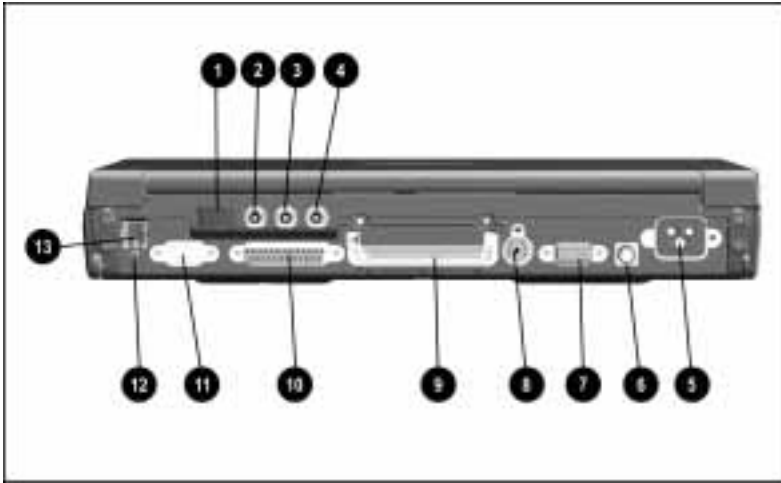

Rear Components

Component	Function
① USB connector	Connects a Universal Serial Bus (USB) device or a hub that connects multiple USB devices.*
② Mono microphone jack	Connects an external monophonic microphone.
③ Stereo speaker/headphone jack	Connects stereo headphones or external stereo speakers to the computer. This jack is driven by an amplifier and has volume control. The internal computer speakers are turned off when external speakers are plugged into this jack.
④ Stereo line-in jack	Connects a CD player, tuner, or tape deck to the computer.
⑤ Power connector	Connects a power cord to the computer.
⑥ DCN connector	Connects an optional Auto/Aircraft Adapter to the computer.

Continued

Rear Components *Continued*

Component	Function
⑦ External monitor connector	Connects an optional external display, such as an external CRT monitor. Also connects a TV adapter, allowing a TV to be connected to the computer.
⑧ Keyboard/mouse connector	Connects an optional full-sized keyboard or a PS/2 compatible mouse. An optional splitter/adaptor allows the connection of both an external keyboard and external mouse at the same time.
⑨ Docking connector	176-pin expansion bus connector that connects the computer to the desktop expansion base or convenience base.
⑩ Parallel connector	Connects an optional parallel device such as a printer.
⑪ Serial connector	Connects an optional external serial device such as a printer or mouse.
⑫ Infrared port	Allows wireless communication between the computer and another infrared-equipped device, using an infrared light beam.
⑬ RJ-11 jack	Connects a standard telephone cable to the computer in North America, Latin America, Hong Kong, and Japan. (This connector may be blocked in other countries. Refer to the 25-pin connector located on the right side of the computer.)

*The USB connector is a powered hub. If you are running Windows 95 or higher or Windows NT 5.0 or higher, you can safely connect up to five powered hubs to the computer, or up to five powered and unpowered hubs in any sequence as long as two unpowered hubs are not connected to each other.

If you are running an earlier version of Windows 95 or Windows NT, or if you are running a different operating system, you can connect one hub.

Right Side Components

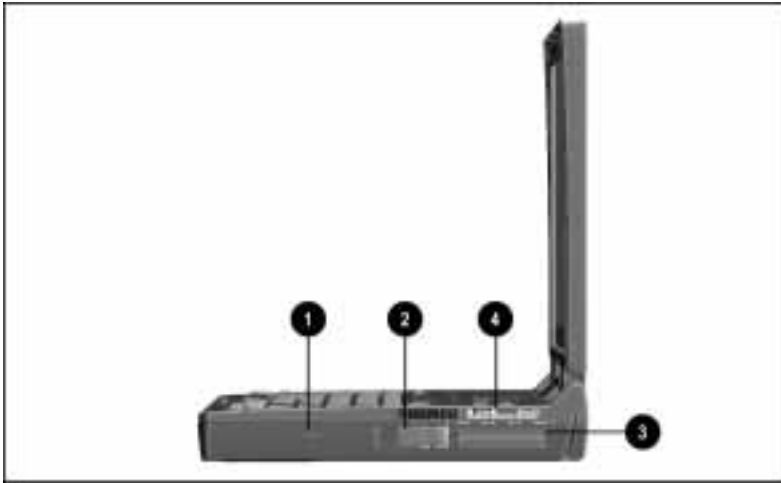

Right Side Components

Component	Function
❶ Security slot	A slot for an optional cable lock to secure the computer to a fixed object.
❷ PC Card eject levers	Located on the right side of the computer and used to release the PC Cards from the PC Card slots.
❸ PC Card slots	Slots that support Type I, II, or III PC Cards such as hard drive cards or network cards. These slots support 16-bit PC Cards as well as CardBus (32-bit) PC Cards.
❹ 25-pin connector	Connects a country-specific modem cable to the computer in all countries except those in North America, Latin America, Hong Kong, or Japan. (North America, Latin America, Hong Kong, and Japan refer to the RJ-11 jack located on the rear of the computer.) Also used connects a cellular phone in North America only.

Top Components

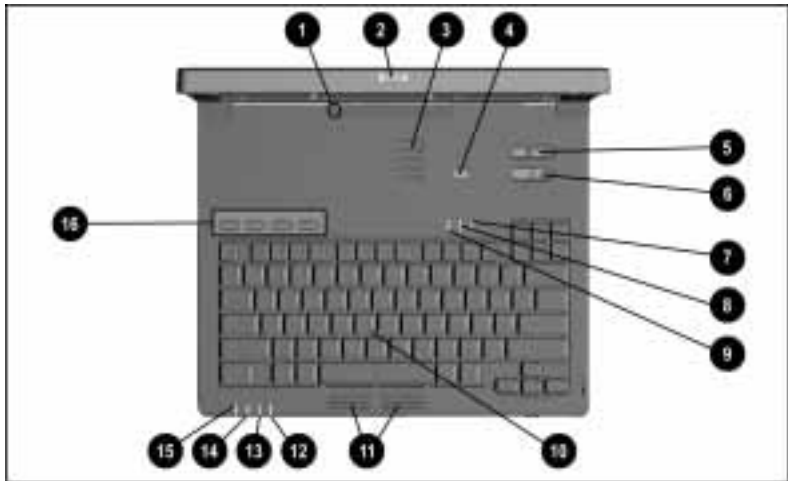

Top Components

Component	Function
① Display switch	Turns off the display if the display is closed while the computer is still on. If warning beeps are enabled in Computer Setup, a beep will sound if the display is closed when the computer is on.
② Display release latch	Located on top of the display and used to open the computer. Slide the display release latch to the right to open the computer.
③ Vents	Provide airflow intake into the computer and to the fan to assist in cooling the internal components of the computer. To help prevent overheating of the computer, do not block the vents.
④ Suspend button	Initiates and exits Suspend. Turns on the computer if it is off. If the computer is docked in the expansion base, also turns on the expansion base. When used with the Fn key on the computer, initiates Hibernation.

Continued

Top Components *Continued*

Component	Function
⑤ Volume control	Controls volume to the built-in speakers or to external speakers or headphones plugged into the stereo speaker/headphone jack on the computer.
⑥ Power switch	Turns the computer on or off, or exits Suspend. When the computer is in Suspend, sliding the power switch exits Suspend but does not turn off the computer.
⑦ Num Lk light	Num Lk is on, which enables the embedded numeric keypad.
⑧ Scroll Lock light	Scroll Lock is on, which causes the cursor to scroll by fields rather than by lines.
⑨ Caps Lock light	Caps Lock is on, which causes new text to be typed in uppercase letters.
⑩ EasyPoint III pointing device	Provides mouse functions in all software that supports a Microsoft-compatible mouse.
⑪ Right and left mouse buttons	Initiates an action or confirms a selection.
⑫ MultiBay drive light	Green light that indicates when the MultiBay device is being accessed. Also indicates when a battery pack is installed in the MultiBay that is charging or waiting to be charged.
⑬ Hard drive light	Green light that indicates when the hard drive is being accessed.
⑭ Battery power light	Turns on when a battery pack in the computer is charging. Turns off when the battery pack is fully charged. Blinks to indicate a low battery condition or a defective battery.
⑮ Power/suspend light	Turns on when power is turned on. Turns off when power is turned off. Flashes to indicate the computer is in Suspend.
⑯ Programmable Keys	Opens an application, opens a document, or emulates one of the Microsoft Windows and Application Logo Keys.

Bottom Components

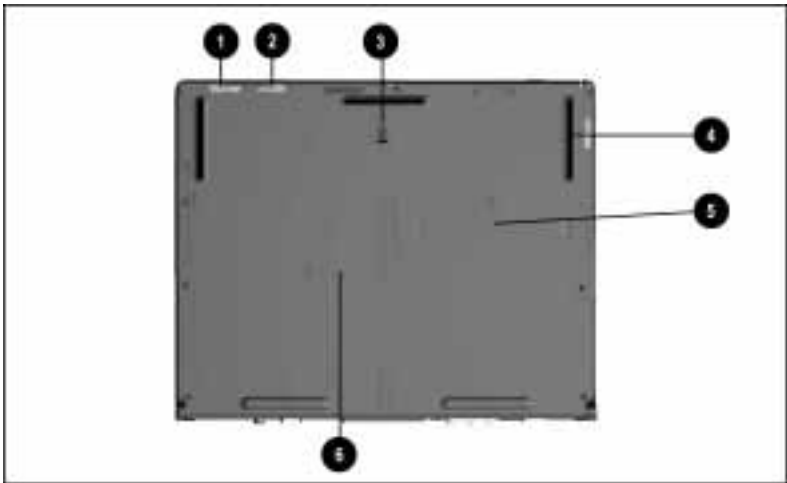

Bottom Components

Component	Function
❶ Battery release latch	Releases the battery pack from the battery bay.
❷ Hard drive release latch	Releases the hard drive from the hard drive bay.
❸ Docking restraint latch recess	Helps to secure the computer to the desktop expansion base.
❹ MultiBay release latch	Releases a removable hard drive, CD-ROM drive, diskette drive, or battery pack in the MultiBay.
❺ Memory expansion slot cover	This cover must be removed in order to install an optional memory expansion board.
❻ Serial number	Bar-coded label.

Display Controls

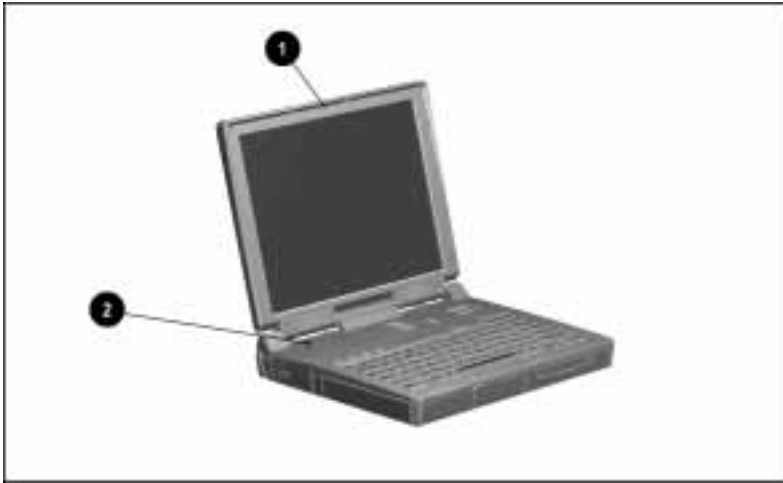

Display Controls

Component	Function
① Display release latch	Slides to the right to open the computer.
② Display switch	Turns off the display if the display is closed while the computer is still on. If warning beeps are enabled in Computer Setup, a beep sounds if the display is closed when the computer is on.

MPEG Overview

MPEG (Moving Pictures Experts Group) refers to a type of data compression optimized for video and audio data. By analyzing the changes between frames (differencing), an MPEG encoder is able to reduce the file size of the data by a ratio of up to 200 to 1. This compression method provides true full-screen and full-motion video and CD quality audio to be stored in a relatively small sized file. Once the data has been compressed, however, it must be decompressed before it can be used.

MPEG decoder software, which decompresses MPEG data at a very high speed, plays back MPEG streams at a data transfer rate of 150 kilobytes per second. This gives ordinary PCs the ability to play back full-motion MPEG sequences from standard CD-ROM drives.

USB Overview

Your computer comes equipped with a port which connects Universal Serial Bus (USB) devices to the computer. This port allows you to connect a device and still have ports open for connecting other devices.

Your computer can support the following USB devices: a hub, a keyboard, and/or a mouse. Later versions of the Windows operating systems will add functionality which will allow you to attach any USB device to your computer (for example, a video camera).

A USB keyboard and mouse, optionally connected through a hub, offer the same functionality as a standard keyboard and mouse connected through the keyboard/mouse connector. Future operating systems will have extended USB capabilities which will replace the USB capabilities built into the computer.

Ordering Preinstalled Software

Compaq recommends that you use a backup program to create a backup of the preinstalled software. However, for an additional cost, you can order a backup of the preinstalled software on a CD-ROM or on diskettes.

If an order form was included with the computer, complete the form and return it, or call one of the numbers listed on the order form. If an order form was not included with the computer, refer to the Compaq worldwide telephone numbers in Appendix A, "Compaq Customer Support."

IMPORTANT: Have the computer serial number available when you call Compaq. The serial number is on the bottom of the computer.

chapter 3

USING THE KEYBOARD AND POINTING DEVICE

Using the Pointing Device

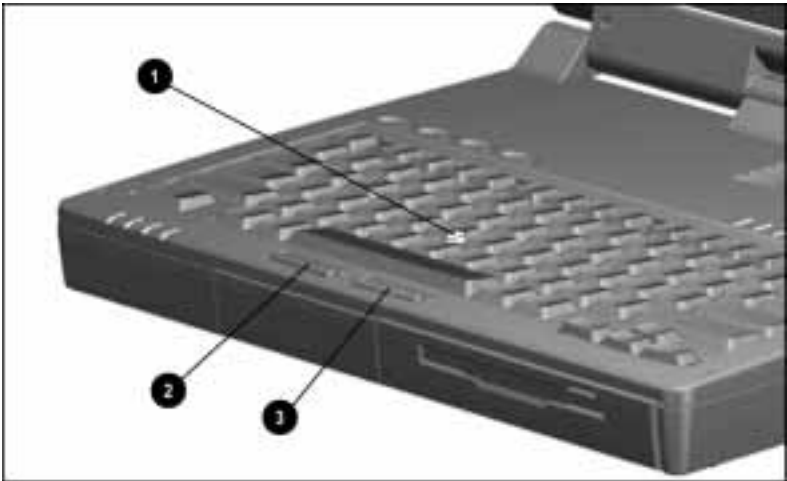

Pointing Device Components

Component	Function
① EasyPoint III pointing device	Provides mouse functions in all software that supports a Microsoft-compatible mouse.
② Left mouse button	Initiates an action or confirms a selection.
③ Right mouse button	Initiates an action or confirms a selection.

The pointing device performs the same basic operation as a mouse. The pointing device senses finger movement; the device itself does not move.

- 1 Place your index finger on top of the pointing device.
- 2 Press in the direction you want the cursor to move on the screen.
- 3 Click the left or right mouse button with your thumb.

Keyboard Components

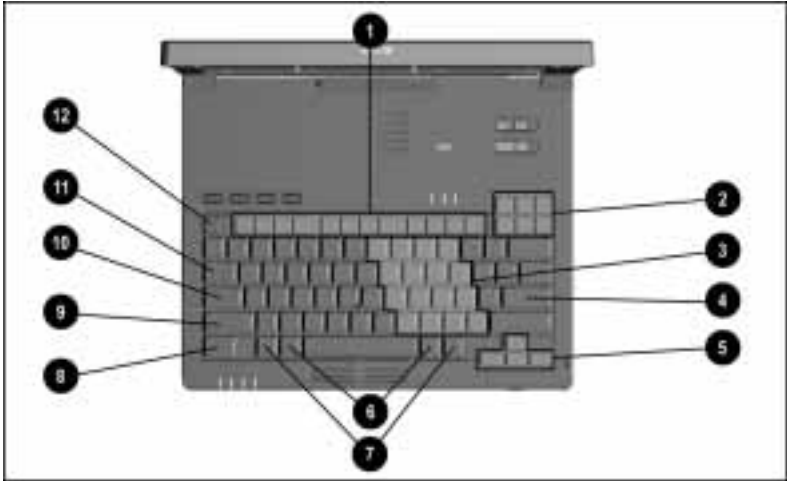

- ❶ Function keys (F1-F12)
- ❷ Screen control keys
- ❸ Embedded numeric keypad
- ❹ Enter key
- ❺ Cursor keys
- ❻ Alt keys
- ❼ Ctrl keys
- ❽ Fn key
- ❾ Shift key
- ❿ Caps Lock key
- ⓫ Tab key
- ⓬ Esc key

Hotkey Quick Reference

Hotkeys are keys that simplify performing special computer operations. The special hotkey features are activated by pressing the **Fn** key and the function key. The function keys work as normally defined by application software when they are not used in conjunction with the **Fn** key.

Hotkey Quick Reference		
Function	Hotkeys	Return to Original State
Moving the hotkey popup window location	Fn+F1	Fn+F1
Switching displays	Fn+F4	Fn+F4
Adjusting system warning beep volume	Fn+F5	Fn+F5
Initiating QuickLock/QuickBlank	Fn+F6	Enter power-on password
Selecting a power management level	Fn+F7	Fn+F7
Accessing the battery gauge	Fn+F8	Fn+F8
Adjusting the brightness control	Fn+F10	Fn+F10
Displaying the BIOS version number	Fn+Esc	Fn+Esc
Accessing the embedded numeric keypad	Fn+Num Lk	Fn+Num Lk
Stretching Text	Fn+T	Fn+T

NOTE: Hotkeys work on the computer keyboard or an external keyboard connected through the keyboard/mouse connector or the USB connector when the computer is undocked. However, if you upgrade your operating system, hotkey functionality for a USB keyboard may be disabled.

To enable hotkeys on an external keyboard, press the Scroll Lock key twice within one second. If a hotkey (including arrow keys) is not pressed within five seconds, the feature is disabled.

Moving the Hotkey Popup Window Location

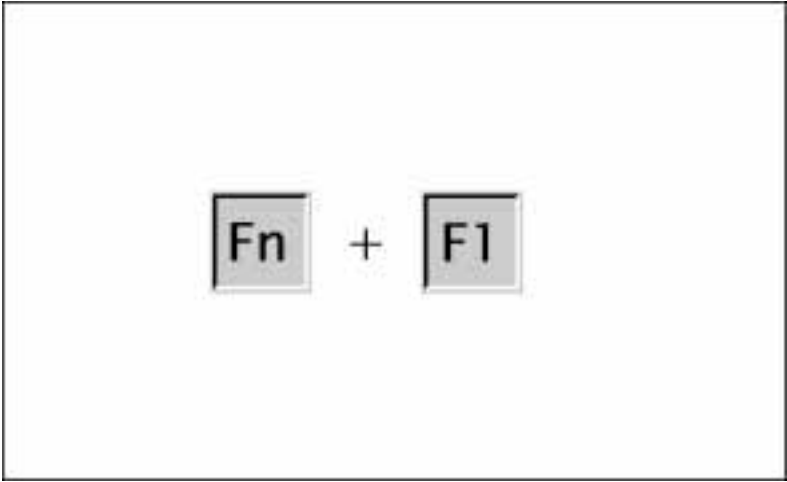

- Press the **Fn+F1** hotkeys to move the popup window location.
- Press the up and down arrow keys to move the icon up or down.
- Press the left and right arrow keys to move the icon left or right.

Switching Displays

Press the **Fn+F4** hotkeys to display information on the computer display, external monitor, or TV screen.

Pressing these hotkeys toggles between several display modes, depending on the equipment connected to the computer. All scenarios assume you are starting from the computer display enabled. Refer to the chart below for the various display scenarios.

Connected Device(s)	Press Fn+F4 First Time	Press Fn+F4 Second Time	Press Fn+F4 Third Time
External monitor	Simultaneous display of external monitor and computer display enabled	External monitor enabled	Computer display enabled
TV	Simultaneous display of TV and computer display enabled (only available in Windows; cannot be used in DOS mode)	TV display enabled	Computer display enabled
No equipment attached	Computer display enabled	N/A	N/A

Adjusting System Warning Beep Volume

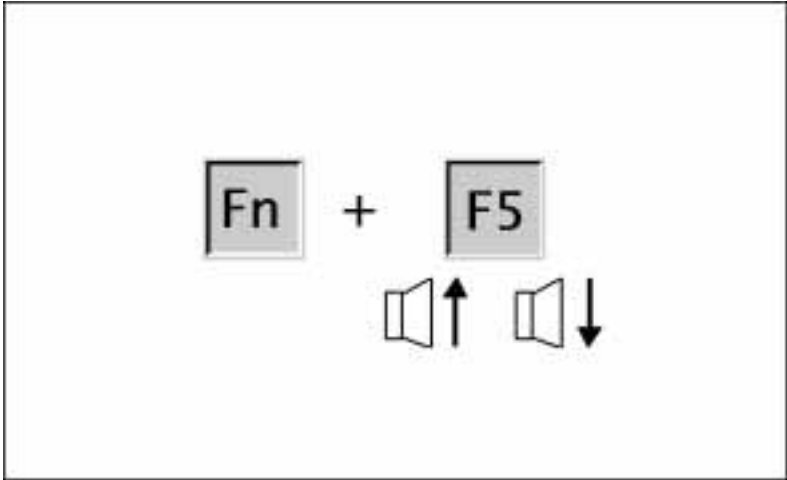

Press the **Fn+F5** hotkeys to adjust the system warning beep volume.

- To increase volume, press the right arrow key.
- To decrease volume, press the left arrow key.

(The arrows in this illustration indicate the increase or decrease in volume levels.)

Initiating QuickLock/QuickBlank

IMPORTANT: Before QuickLock/QuickBlank can be initiated, a power-on password must be set and QuickLock/QuickBlank must be enabled.

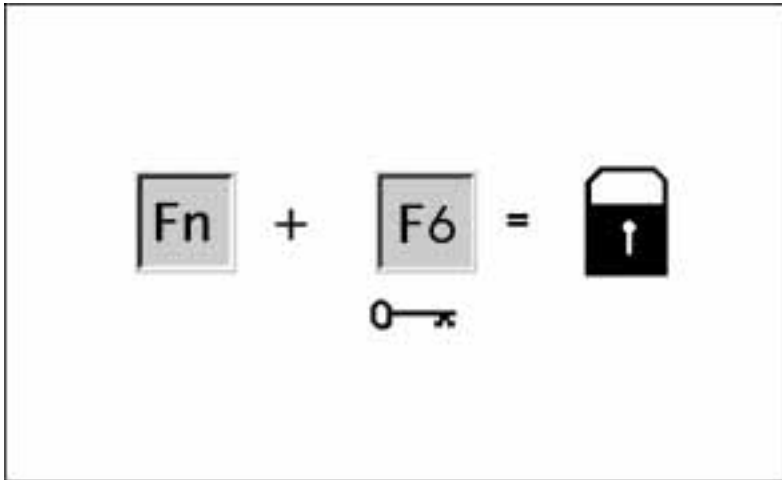

Press the **Fn+F6** hotkeys to initiate QuickLock/QuickBlank at any time and from within any application. This hotkey

- Disables the keyboard and the pointing device.
- Clears the display.

To reenble the keyboard and return your information to the screen, enter your power-on password.

Selecting a Power Management Level

Use the **Fn+F7** hotkeys to

- Select one of the three preset power conservation levels.
- Customize the power conservation level.

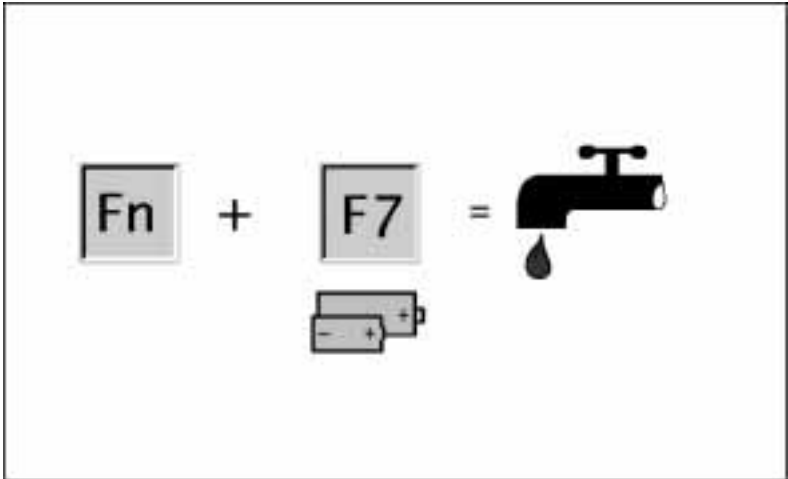

- Press the **Fn+F7** hotkeys to view or change the Power Management level.
- Press the left or right arrow keys to select a different level.

The power conservation level assists you in extending the life of the battery pack(s).

Accessing the Battery Gauge

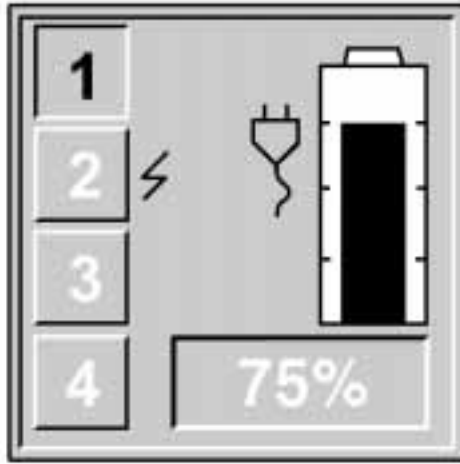

Press the **Fn+F8** hotkeys to show the status of the battery pack(s). Four numbered boxes indicate the status of each installed battery pack:

- Battery pack 1—Primary battery in the computer battery bay.
- Battery pack 2—Battery in the computer MultiBay.
- Battery pack 3—Battery in the expansion base MultiBay or the convenience base battery charging bay.
- Battery pack 4—Battery in the converted expansion base half-height bay or the convenience base MultiBay.

Press the right or down arrow key to view the status of the next battery pack. If a battery pack is not in a bay, the corresponding bay cannot be selected. Press the left or up arrow key to select the previous battery pack.

Adjusting the Brightness Control

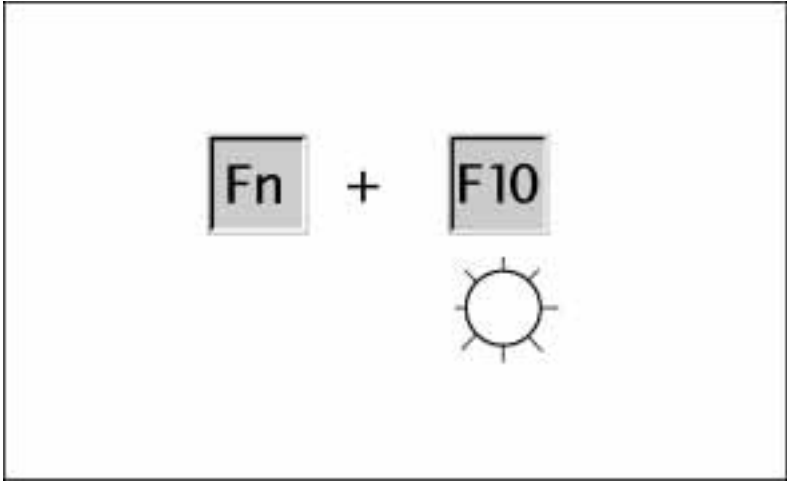

Press the **Fn+F10** hotkeys to adjust the display brightness:

- Press the right arrow key to increase light intensity.
- Press the left arrow key to decrease light intensity.

Accessing the BIOS Version Number

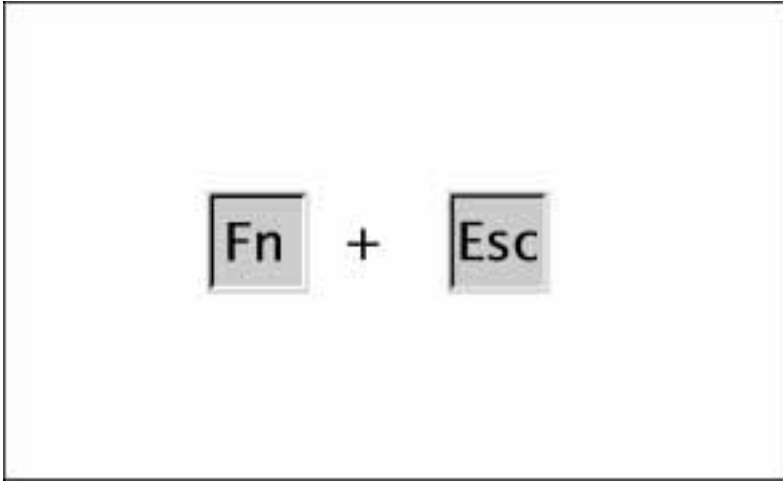

Press the **Fn+Esc** hotkeys to find out what version of BIOS you are running.

BIOS stands for “Basic Input/Output System” and is a ROM-resident software that provides basic functionality for the computer.

Press the up and down arrow keys to display other software version numbers.

Accessing the Embedded Numeric Keypad

The embedded numeric keypad is a section of the computer keyboard that converts to a numeric keypad when the number lock function is enabled.

NOTE: The embedded numeric keypad is disabled if an external keyboard or keypad is attached.

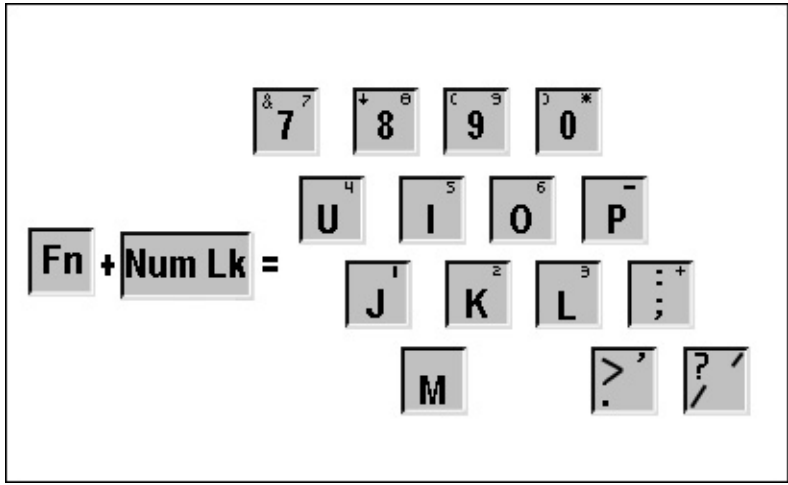

Press the **Fn+Num Lk** hotkeys to

- Enable the embedded numeric keypad. (Num Lk light turns on).
- Disable the embedded numeric keypad. (Num Lk light turns off).

With the number lock function on (enabled)

- Press **Fn** to type lowercase letters.
- Press **Fn+Shift** to type uppercase letters.
- Press and hold **Fn** or **Fn+Shift** during the entire operation.

Stretching Text

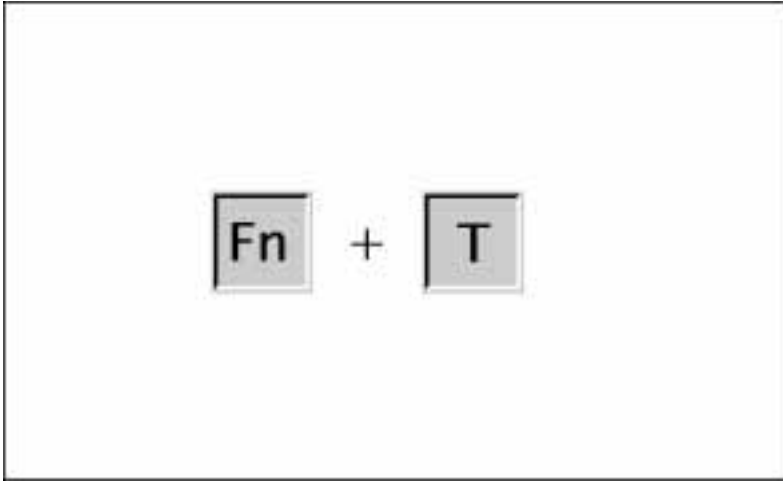

To stretch the image so that more of the screen is filled, press the **Fn+T** hotkeys.

The **Fn+T** function is available whenever the desktop area resolution is set lower than the resolution of the internal display device (LCD).

When running MS-DOS under Windows (text mode), toggle the **Fn+T** hotkeys to switch between stretched text mode and regular mode. The default is for text stretch to be on. Text mode settings will default to whatever you saved when you restart the computer.

When running any Windows operating system (graphics mode), toggle the **Fn+T** hotkeys to switch between stretched mode and regular mode. The default is for text stretch to be off. Graphics mode settings will go back to text stretch off when you restart the computer.

Text stretch must be turned off for hardware video acceleration to be enabled.

Programmable Keys Overview



- ❶ First Programmable Key
- ❷ Second Programmable Key
- ❸ Third Programmable Key
- ❹ Fourth Programmable Key

Programmable Keys allow you to assign functions such as opening an application or bringing up a document.

You can assign the programmable keys to quickly open an application on your computer, bring up a document, or emulate one of the Microsoft Windows and Application Logo keys.

By assigning the programmable keys to schemes, you can create multiple sets of key assignments to tailor your computer for various uses or accommodate more than one user.

Assigning or Reassigning Programmable Keys

- 1 Access the Programmable Keys utility.
- 2 Select the programmable key you wish to assign or reassign for the current scheme by clicking its radio button in the Key assignments box.

NOTE: To assign keys in other than the current scheme, click Show Advanced Options and look in the Scheme box to choose another scheme. You can create a new scheme if necessary. If you have never created a scheme, the Default scheme is used.

- 3 Click the Browse button.

NOTE: To access a larger number of programs, click Show Advanced Options. Click the Browse button to access all applications on your computer. To emulate one of the Microsoft Windows and Application Logo Keys, select the appropriate file from the windows\cpqwin folder.

- 4 Highlight the application you want and click OK.
- 5 Click OK to exit the utility.

When you press the programmable key you assigned, your application or document appears on the screen.

Unassigning Programmable Keys

- 1 Access the Programmable Keys utility.
- 2 Select the programmable key you wish to unassign and click the corresponding button in the Key assignments group box.
NOTE: To unassign keys in other than the current scheme, click Show Advanced Options and select a different scheme. If you have never created a scheme, the Default scheme is the only choice.
- 3 Click the Assign button, then select Unassigned from the list.
NOTE: When the Show advanced options checkbox is checked, you can unassign a programmable key by clicking the Browse button and selecting the file 'Unassigned' from the windows\cpqwin folder.
- 4 Click OK to exit the utility.

Adding Schemes

Schemes are a collection of up to four programmable key assignments that you define, and that are unique to your Windows user profile. You can create multiple schemes. For example, you can create a scheme called Home that contains key assignments for programs you use at home, and a scheme called Work for programs that you use at work.

To add a new scheme:

- 1 Access the Programmable Keys utility.
- 2 Place a check in the Show Advanced Options checkbox if one is not already there.
- 3 Click the Add button.
- 4 Type the name of your new scheme in the popup dialog box that appears.
- 5 Make your programmable key assignments.
- 6 Click OK to exit the utility.

Removing Schemes

- 1 Access the Programmable Keys utility.
- 2 Place a check in the Show advanced options checkbox if one is not already there.
- 3 Select the scheme you want to remove from the drop-down list.
NOTE: The Default scheme is not removable.
- 4 Click the Remove button.
- 5 Click OK to exit the utility.

Showing the Key Assignments in the System Tray

One convenient way to see your programmable key assignments is to view them in a popup window that you activate from an icon in the system tray. The system tray is the box in the lower-right corner of the taskbar. To enable the icon:

- 1 Access the Programmable Keys utility.
- 2 Place a check in the Show key assignments in the System Tray checkbox.
- 3 Click OK to exit the utility.

To view the popup window, click the icon in the system tray.

NOTE: The icon remains in the system tray until you disable it by unchecking the Show key assignments in the System Tray checkbox or by right-clicking the icon and choosing Exit from the menu.

chapter 4

USING POWER AND POWER MANAGEMENT

Leaving On the Computer

When you need to leave the computer unattended but don't want to turn it off, you can conserve power by initiating Suspend. Always initiate Suspend when a battery pack is your only power source. With a fully charged battery pack, Suspend extends the battery operating time.

NOTE: Frequent discharging and recharging cycles shorten the life of the battery pack.

Turning Off the Computer

- 1 Save open files.
- 2 Exit open applications.
- 3 Click Start → Shut Down.

If you plan to store the computer for two weeks or more, remove the battery pack from the computer battery bay. This reduces the battery discharge rate and extends battery pack operating life.

Power Management Overview

The computer comes standard with a collection of power management features that allow you to extend battery operating time and conserve power.

Power management monitors most of the computer components such as the hard drive, processor, and display. When a component is inactive for a specified period of time, called a timeout, you can use power management settings to shut it down temporarily. For example, the timeout preset for hard drive inactivity is two minutes. If a software application does not access information on the hard drive for two minutes, the drive spins down until the next time it is accessed.

Accessing Power Management

Click Start → Settings → Control Panel → double-click Power to view or set the following in Power Properties.

If You Want To:	Click This Tab:
Show Suspend on the Start menu or battery meter on the taskbar	Power (Windows 95 only)
Set timeouts for drives when using battery power or AC power	Disk Drives (Windows 95 only)
Enable/disable Energy Saver and customize Energy Save monitor values	AC Energy Saver (Windows NT only)
Turn off power to the PC Card slots	PC Card Modems (Windows 95 only)
Set battery conservation levels; enable/disable warning beeps; set timeouts	Battery Conservation Settings
Select Hibernation settings; set Hibernation timeout	Hibernation
Display the status of installed batteries	Battery Status
Set date and time to exit Suspend; enable/disable Resume Timer	Resume Timer

Setting the Power Management Level

Power Management Levels

To extend the life of your battery packs, use the Battery Conservation tab in Power Properties. You can customize the level of battery conservation or use one of four power management levels:

- **High**—Select this level for the maximum amount of power conservation possible in an automatic setting. Using this level, you receive the most battery operating time from a single charge.
- **Medium**—Select this level for a balance between performance and battery operating time. This is the default setting.
- **Custom**—Select this level to customize timeout settings for:

Windows 95

Suspend
System idle
Screen save
Processor speed
Brightness

Windows NT

Suspend
Hard disk idle
System idle
Screen save
Processor speed
Brightness

NOTE: The custom level default settings are the same as the medium level until you set your own values.

- **None (Drain)**—Provides the maximum battery drain because battery conservation is turned off. The computer runs at full speed if no power conservation level is selected.

Setting the Power Management Level With Power Properties

Change the default levels of battery conservation through the Conservation Settings tab in Power Properties. Choose a preset level or customize your own.

The level you set remains in effect until you change it.

Setting the Power Management Level With Computer Setup

If you are experiencing difficulty accessing Power Properties through Windows, you may set Power Management using Computer Setup.

- 1 Run Computer Setup.
- 2 Click the System Features icon.
- 3 Click the Power Management box.
- 4 Click the Battery Conservation tab.
- 5 Select a battery conservation level.
- 6 Click OK.

Suspend Overview

Suspend is a condition in which the computer uses a low amount of power by shutting down most of the subsystems. Suspend can be user-initiated or system-initiated (if a Suspend timeout has been set).

When you initiate Suspend, system information is saved in random access memory (RAM).

Suspend

- Puts the computer to sleep for up to one week, provided a fully charged lithium-ion battery pack is installed.
- Uses very little power.
- Saves your place in your applications.
- Shuts down most major components such as hard drive, processor, and display.

Suspend can be initiated by you (user-initiated) or by the computer (system-initiated).

Initiating Suspend

- User-initiated Suspend
 - Press the suspend button at any time or from anywhere in an application.
- or
- Click Start → Suspend.



■ System-initiated Suspend

- Initiates after five minutes (default) or a user-selected timeout during normal battery operations.
- Initiates when the system reaches a critical low battery condition and Hibernation has been disabled.



CAUTION: If Hibernation is disabled, the computer does not initiate Hibernation when a critical low battery condition is reached. Instead, it initiates Suspend. When the battery pack fully discharges, all unsaved data is lost.

NOTE: When you close the display while the computer is on, the screen clears, but the computer *does not* initiate Suspend.

When Suspend is initiated, the

- Screen clears.
- Power/suspend light blinks.
- Computer beeps twice.

NOTE: During Suspend the screen is blank. However, unlike when the computer is turned off, your information returns to the screen when the suspend button is pressed.

Exiting Suspend

- If Suspend was initiated because the timeout expired, press the suspend button ❶ or slide the power switch ❷.



- If Suspend was initiated because the system reached a critical low battery condition while Hibernation was disabled, exit in one of these ways:
 - Connect the power cord or the Automobile Adapter or dock the computer in the optional desktop expansion base or convenience base.
 - Replace the battery pack, then press the suspend button or slide the power switch.

When you exit Suspend, the computer

- Beeps twice.
- Power/suspend light stops blinking but remains on.
- Returns your information to the screen.

NOTE: When you exit Suspend, your information returns to the screen at the point where Suspend was initiated. No information is lost provided you do not lose battery power while the computer is in Suspend.

Hibernation Overview

Hibernation saves information in memory and turns off the computer.

When Hibernation is initiated, no information is lost. There is no limit to the amount of time the computer can remain in Hibernation, since the computer is turned off and there is no drain on the battery pack.

When the computer is turned on, the information in memory is restored to the screen at the point where Hibernation was initiated.

Hibernation can be used to:

- **Protect information**—Hibernation is a condition that protects against the loss of information from a discharged battery pack when the computer is left unattended. During Hibernation, information in memory is saved to the hard disk, and power is turned off.
- **Act as a place marker**—For example, it is useful when you're making a presentation away from the office. You can do all the preparation in advance, mark your place by initiating Hibernation, and be ready to make your presentation as soon as you arrive.
- **Conserve battery power**—Conserve battery power by customizing the Hibernation timeout to save information in memory after a specified period of inactivity.



CAUTION: It is possible to remove Compaq Power Management from the computer using Add/Remove Programs. Compaq strongly recommends against doing so, however. Removing Compaq Power Management from the computer will cause all Power Management functionality, including Hibernation, to be lost.

Initiating Hibernation

■ User-initiated Hibernation

Press **Fn** and the suspend button simultaneously at any time and from anywhere within an application.

NOTE: Hibernation cannot be initiated when the computer is docked in the desktop expansion base or convenience base.

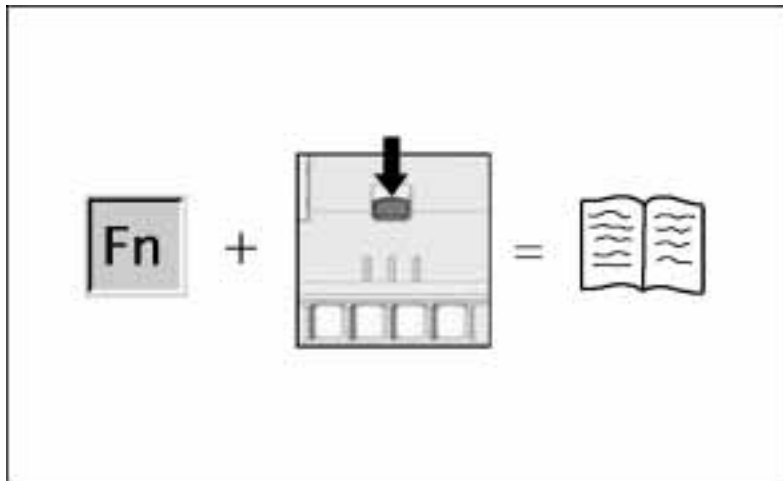

■ System-initiated Hibernation

- Initiates when the computer is on but idle, left unattended, and reaches critical low battery condition.



CAUTION: If Hibernation is disabled, the computer does not initiate Hibernation when a critical low battery condition is reached. If Hibernation is disabled, the computer initiates Suspend until the battery pack fully discharges. When this occurs, all unsaved data is lost.

NOTE: A battery pack that has not been fully charged may not have enough power to support a system-initiated Hibernation at critical low battery.

- Initiates when the Hibernation timeout occurs.

Enabling/Disabling Hibernation

Hibernation is automatically turned on when you first set up the computer. In order for Hibernation to work, it must allocate space on the hard drive equal to the amount of RAM installed. You can disable Hibernation to free up disk space. However, disabling it is not recommended.

NOTE: If you upgrade memory, the computer increases the Hibernation file size to accommodate the additional RAM. When the Hibernation file increases, it requires more hard disk space.

- To disable Hibernation, click Start → Settings → Control Panel → Hibernation tab → Off.
- To enable Hibernation, click Start → Settings → Control Panel → Hibernation tab → On.



CAUTION: If Hibernation is disabled, the computer does not initiate Hibernation when a critical low battery condition is reached. Instead, it initiates Suspend. When the battery pack fully discharges, all unsaved data is lost.

Exiting Hibernation

Select one of the following methods:

- If Hibernation was user-initiated or a low battery condition has been resolved, press the power switch to turn on the computer.
- If the computer is in a critical low battery condition, insert a fully charged battery pack or connect an external power source.

When the computer exits Hibernation, the information saved to the hard disk returns to the screen at the point where Hibernation was initiated.

NOTE: To stop the restoration of information, press **Ctrl+Alt+Del**.

Timeout Overview

A timeout is a specified period of inactivity for the computer or its components. After this time period passes, power management shuts down the computer or its components to save battery power. For example, the hard drive component default timeout is two minutes. Therefore, if an application does not access information on the hard disk for two minutes, the hard drive spins down until the next time it is accessed.

Timeouts work with power management to conserve battery power. Battery power can be conserved by

- Using timeouts that correspond with the preset medium (default) or high level of power conservation.
- Using the custom level of power conservation to set your own timeouts so that they work more efficiently with your applications.

Setting the Screen Save Timeout

If you can't access the screen saver from the Battery Conservation Levels tab in Power Properties:

- 1 Click the right mouse button anywhere on the desktop.
- 2 Click Properties → Screen Saver tab.
- 3 Select a screen saver.
- 4 Set the Custom timeout.
- 5 Click OK.

AC Energy Saver Overview

When the computer is connected to AC power, the AC Energy Saver shuts down the hard drive and initiates the screen saver after set timeouts expire.

Enabling/Disabling PC Card Slots

PC Cards are small form factor options that require power when inserted in the computer. When PC Cards are in the PC Card slots, they draw power from the system even when they are not being used.

If you are running Windows 95, remove a PC Card when it is not being used or turn off power to the PC Card slots through Power Properties. To access Power Properties, click Start → Settings → Control Panel → double-click Power.

If you are running Windows NT, remove PC Cards when they are not being used. This is true regardless of whether or not you are using CardWare 5.0.

If you are operating the computer on a battery pack, disabling power to the PC Card slots extends the battery life. You can also turn off power to the PC Card slot when the computer is in Suspend.

chapter 5

USING BATTERY PACKS

Battery Components

The quick check feature on the lithium-ion (Li-ion) battery pack shows the remaining charge level when the battery pack is outside of the battery bay or MultiBay.

To see the remaining power in the battery pack, press the battery gauge ❶. Five battery charge level lights ❷ indicate the remaining charge level.

Each battery charge light represents 20 percent of remaining charge. For example, if two lights are on, 40 percent charge remains. If all five are on, the battery pack has a full charge.

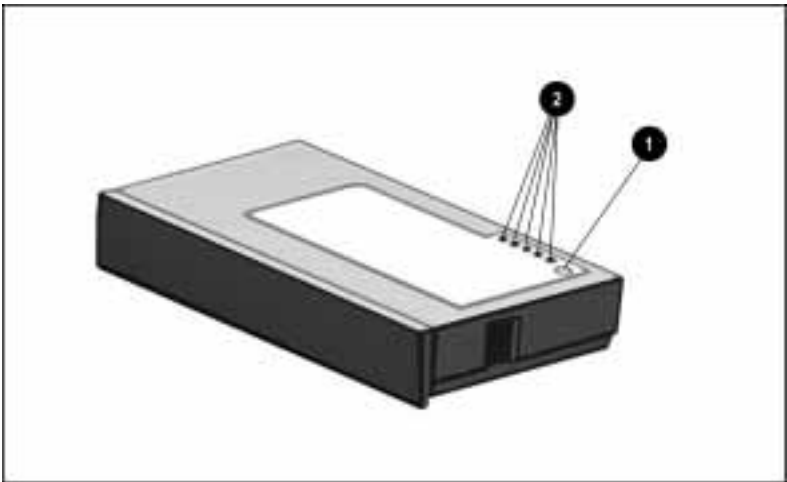

Using a New Battery Pack

A new battery pack should be charged fully before it is used for the first time. The battery pack will work without being fully charged, but the battery gauge will not show an accurate charge until the battery pack receives its first full charge.

You can charge the battery pack in the computer battery bay while the computer is connected to an external power source. You can also charge the battery pack in the desktop expansion base, convenience base, or in the optional Battery Charger.

Charging Battery Packs

Charging Battery Packs in the Computer

If a battery pack has not been used for two weeks or more, you should fully charge it before using it.

Up to two battery packs can be charged in the computer, one battery in the battery bay and one in the MultiBay. To charge battery packs in the computer, connect the computer to an external power source (Automobile Adapter, power cord, optional desktop expansion base, or optional convenience base).

When more than one battery is being charged in the computer, the computer charges the battery pack in the battery bay first, then the battery pack in the computer MultiBay.

The battery power light on the front of the computer turns on when a battery pack in the battery bay is charging. When the battery pack is in the MultiBay, the MultiBay drive light indicates that the battery pack is charging or awaiting a charge.

When the battery pack enters a low battery condition, the light corresponding to that battery flashes. (If two battery packs are in the computer, a low battery condition occurs when the first pack is fully discharged and the second pack is near the end of its charge.)

A fully discharged battery pack charges in approximately 3 hours when the computer is turned off. When the computer is turned on, charge time depends on the amount of power being used by the computer.

Charging Battery Packs Outside of Normal Operating Conditions

Under normal operating conditions, charging a battery pack begins when the computer is connected to a power source (Automobile Adapter, power cord, optional desktop expansion base, or optional convenience base). Although the battery power light may turn on, charging may not occur immediately if one of the following conditions exists:

- The battery pack temperature is outside the normal operating range of 50°F to 104°F (10°C to 40°C).
- The battery pack is below normal discharge levels, which can occur with new battery packs and when a battery pack is not used for two weeks or more.

When the battery reaches the normal temperature and charge level, it begins to charge until it is fully charged.

If a battery pack has not been used for two weeks or more, you should fully charge the battery pack before using it.

Ensuring Battery Gauge Accuracy

The built-in battery gauge, which displays the amount of charge remaining, is precalibrated for accuracy. To ensure continued battery gauge accuracy and to maximize battery operating time:

- Fully charge the battery pack before the first time you use it.
- Allow the battery pack to completely charge before removing external power from the computer, optional desktop expansion base, convenience base, or Battery Charger.
- If the battery has been out of the computer for two weeks or more, fully recharge the battery pack before using it.
- Allow the battery to completely discharge to the low battery condition through normal use before recharging it.

Identifying a Low Battery Condition

The computer beeps every 15 seconds and the battery power light blinks to indicate a low battery condition.

NOTE: Beeps can be turned off using Computer Setup.



CAUTION: When you are alerted to a low battery condition, very little battery charge remains. To prevent loss of data, take immediate action to resolve the low battery condition.

When a low battery condition is reached, save your files and initiate Suspend. You have approximately 10 minutes to resolve the low battery condition before the computer enters the critical low battery condition.

When a critical low battery condition occurs and Hibernation is enabled, the system initiates Hibernation.



CAUTION: If Hibernation is disabled, the computer does not initiate Hibernation when a critical low battery condition is reached. If Hibernation is disabled, the computer initiates Suspend until the battery pack fully discharges. When this occurs, all unsaved data is lost.

Resolving a Low Battery Condition

Resolving a Low Battery Condition by Connecting to an Electrical Outlet

To charge battery packs in the computer while connected to an electrical outlet:

- 1 Connect the power cord to the power connector on the rear panel of the computer.
- 2 Plug the power cord into an electrical outlet.

Up to two battery packs can be charged in the computer while the computer is connected to an external power source. The battery packs charge in the following order:

- Battery pack in the computer battery bay
- Battery pack in the computer MultiBay

Resolving a Low Battery Condition by Connecting to the Automobile Adapter

- 1 Connect the pronged end of the power cord into the Automobile Adapter ❶.
- 2 Connect the power cord to the rear of the computer ❷.



- 3 Insert the large end of the Automobile Adapter cable into the cigarette lighter.

IMPORTANT: Leaving the computer connected to the vehicle with the Automobile Adapter for an extended period of time when the vehicle is off may deplete the vehicle battery. Depletion occurs regardless of whether the computer is turned on or off.



Resolving a Low Battery Condition by Replacing the Battery Pack



CAUTION: If you are removing the battery pack while the computer is on, you can prevent loss of information by initiating Suspend before removing the battery pack. Be sure to replace the discharged battery pack with a charged one within 10 minutes.

- 1 Stop working and save your work immediately.
- 2 Press the suspend button to initiate Suspend.
- 3 Remove the discharged battery pack.
- 4 Insert a fully charged battery pack.
- 5 Press the suspend button again to exit Suspend.
- 6 Continue your work.

Resolving a Low Battery Condition With No Power Sources Available

Use one of the following methods:

- Initiate Hibernation until a power source is available.
- Turn off the computer until a power source is available.

Replacing Battery Packs

Removing the Battery Pack from the Battery Bay



CAUTION: If you are removing the battery pack while the computer is on, you can prevent loss of information by initiating Suspend before removing the battery pack. Be sure to replace the discharged battery pack with a charged one within 10 minutes

- 1 Save your data.
- 2 If the computer is turned on, press the suspend button. If there is hard drive or diskette activity, Suspend may not occur instantly.

The computer screen clears, and the power/suspend light begins to flash when Suspend has been initiated.

- 3 Tilt the computer at an angle ❶ and slide the battery release latch ❷ to the right while pulling on the notch under the battery bay.

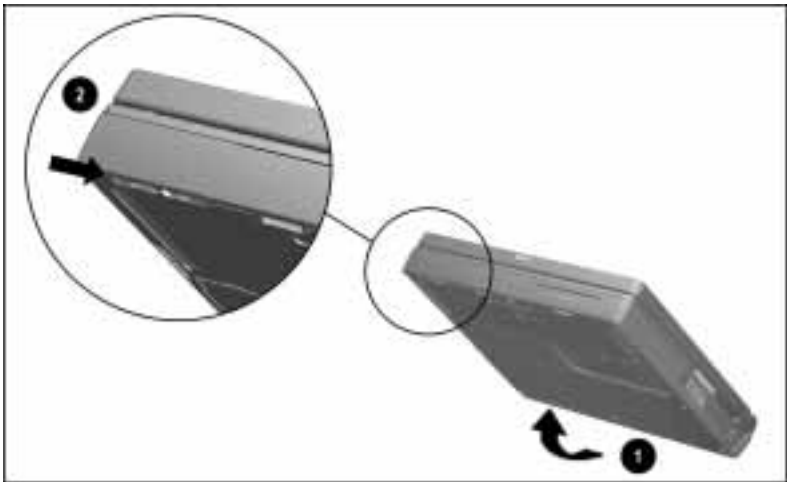

4 Remove the battery pack.



Inserting the Battery Pack in the Battery Bay



CAUTION: If you are removing the battery pack while the computer is on, you can prevent loss of information by initiating Suspend before removing the battery pack. Be sure to replace the discharged battery pack with a charged one within 10 minutes.

- 1 With the large label on the battery pack facing up and the battery contacts facing in, insert the battery pack into the battery compartment.



- 2 If the computer is in Suspend, press the suspend button to resume normal operation.

Removing the Battery Pack from the MultiBay



CAUTION: If you are removing the battery pack while the computer is on, you can prevent loss of information by initiating Suspend before removing the battery pack. Be sure to replace the discharged battery pack with a charged one within 10 minutes.

- 1 If the computer is turned on, press the suspend button. If there is hard drive or diskette activity, Suspend may not occur instantly.
- 2 Tilt the computer at an angle ❶ and slide the MultiBay release latch ❷ away from the MultiBay while pulling on the notch under the MultiBay.

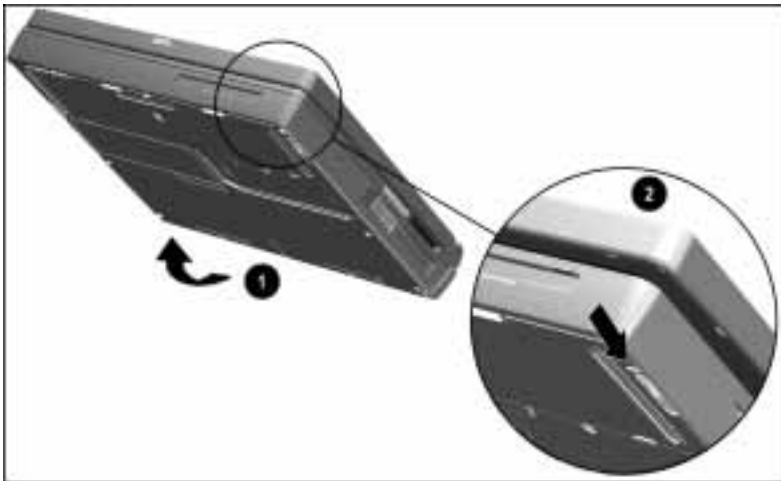

3 Remove the battery pack.



Inserting the Battery Pack in the MultiBay



CAUTION: If you are removing the battery pack while the computer is on, you can prevent loss of information by initiating Suspend before removing the battery pack. Be sure to replace the discharged battery pack with a charged one within 10 minutes.

- 1 With the large label on the battery pack facing up and the battery contacts facing in, insert the battery pack into the MultiBay.

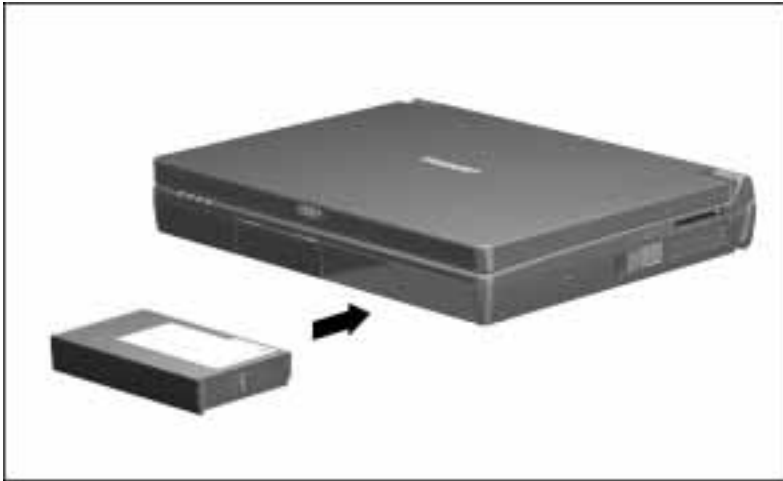

- 2 If the computer is in Suspend, press the suspend button to resume normal operation.

Storing Battery Packs

When storing the computer for more than two weeks, remove the battery packs and store them separately to reduce the discharge rate and increase battery life.

Battery packs self-discharge even when they are not being used. The rate of self-discharge is affected by temperature. To prolong battery charge, store them in a cool, dry place. High temperatures cause battery packs to lose their charge more quickly, thus reducing battery life.

The recommended storage temperature range is from -4°F to 86°F (-20°C to 30°C).



CAUTION: To prevent damage to a battery pack, do not expose it to high temperatures for extended periods of time.

Maximizing Battery Pack Life

Battery pack operating time varies depending on the system components, options, and applications being used. You can increase battery operating time by as much as 50 percent by controlling the energy required by the computer and the energy stored in the battery pack.

NOTE: The display, processor, CD-ROM drive, and hard drive components use the majority of battery power.

Maximize battery pack life using one or more of the following methods:

- Select the High level of power management.
- Initiate Suspend or Hibernation or turn the computer off when you are not using it.
- Reduce the display brightness and select a shorter screen save timeout.
- Avoid charging battery packs when it is not necessary. Unnecessary charging cycles reduce the life of the battery.
- Keep a battery pack in the computer when you're using the computer with external power.
- Disconnect external equipment that does not have its own power source. (External equipment connected to the computer drains the battery pack.)
- Exit modem programs when you are not using them.
- Remove a PC Card when you are not using it.
- When storing the computer for more than two weeks, remove battery pack(s) and store them separately to reduce the discharge rate and increase battery life.
- Storing the battery pack in a cool, dry place when it is not in use. The recommended storage temperature range for the battery pack is from -4°F to 86°F (-20°C to 30°C). High temperatures cause a battery pack to lose its charge more quickly and reduce battery pack life.
- Format diskettes while using external power when possible. (Formatting diskettes increases the drain on a battery pack.)

Beeps When Display is Closed and Computer is Turned On

The computer beeps three times every two seconds to notify you that the display is closed and the computer is still on.

To turn off the beeps without turning off the computer:

- 1 Open the computer.
- 2 Initiate Suspend by pressing the suspend button.

The beeps stop and the computer begins conserving battery power.

Recycling Used Battery Packs

To find out if the battery pack recycling program is available in your geographical location, check the worldwide telephone numbers in Appendix A. If a number for recycling is not listed for your area, contact your Compaq authorized dealer, reseller, or service provider.

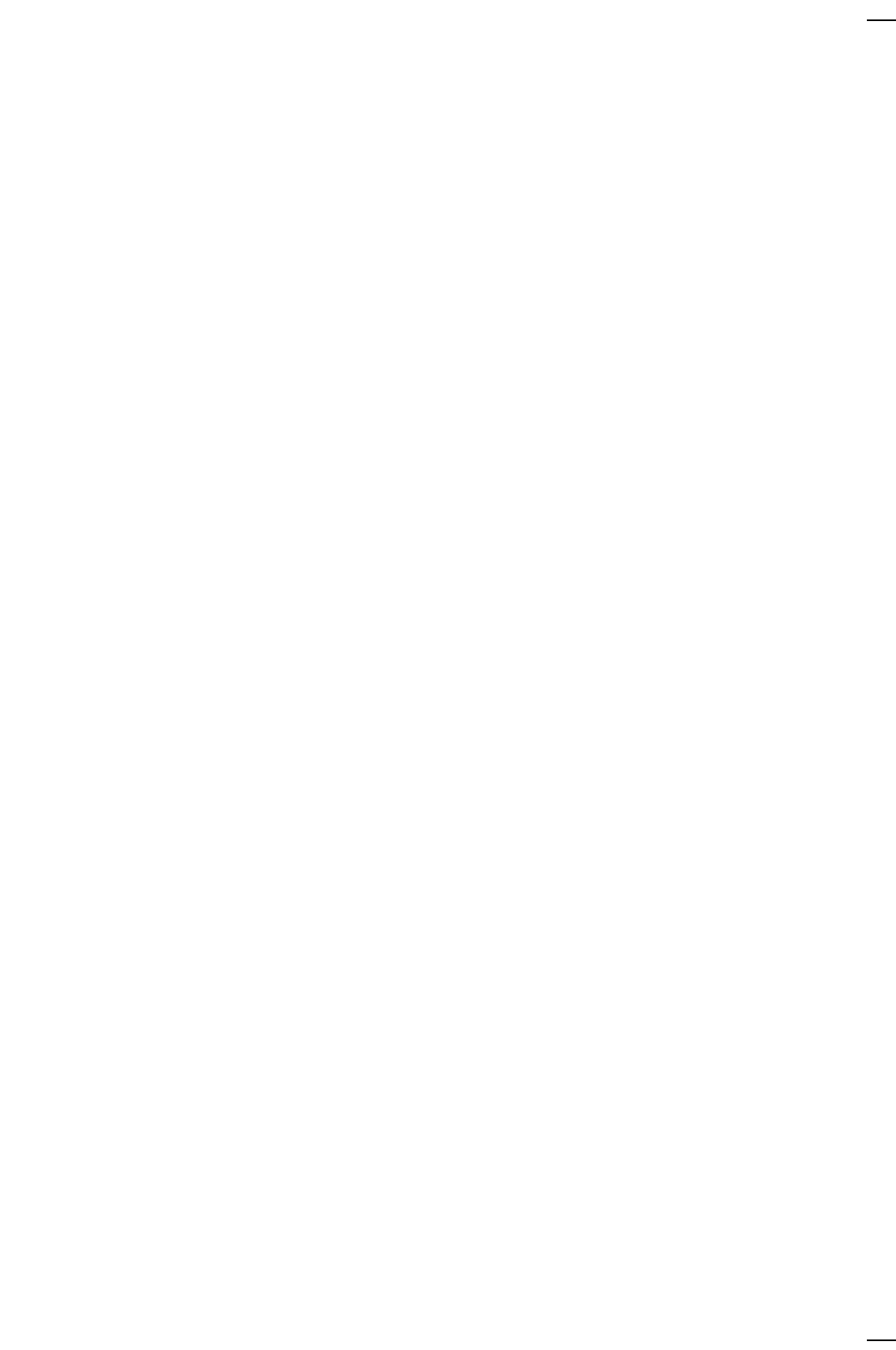

chapter 6

WORKING WITH REMOVABLE DRIVES

Removable Drive Bays

The computer has two bays for removable drives:

- A hard drive bay that supports only the primary hard drive.
- A MultiBay that supports a diskette drive, CD-ROM drive, secondary hard drive, or second battery pack.

The optional desktop expansion base has two bays:

- A MultiBay that supports a diskette drive, CD-ROM drive, second hard drive, or second battery pack.
- A half-height bay that supports standard half-height drives and can be converted to a MultiBay by installing a Half-Height MultiBay Adapter.

The optional convenience base has a MultiBay that supports the same devices as the computer MultiBay.

When the computer is docked in the expansion base or convenience base and you want to use an assortment of removable drives, certain drive configuration parameters apply.

An Armada 7000 Hard Drive MultiBay Adapter is required to use a hard drive in a MultiBay.

Caring for Removable Drives

Removable drives (hard drive, CD-ROM drive, diskette drive) are fragile computer components that must be handled with care.



CAUTION: To prevent damage to the computer or removable drive or loss of information, observe the following precautions.

- Back up the information on a hard drive before removing it. Failure to back up the hard drive can result in loss of information if the drive is handled improperly.
- If there is a diskette or CD in a drive, remove it prior to removing the drive from the computer.
- Do not remove a CD-ROM drive with the tray extended. Before removing the drive, push the drive tray into the drive.
- Turn off the computer before removing or inserting a hard drive.
- Ensure that you are discharged of static electricity before handling a removable drive. Electrostatic discharge can damage electronic components. When handling a removable drive, always grasp the outer case and avoid touching the connectors.
- Do not use force when inserting a drive into a bay. Excessive force may damage the connectors.
- Carefully handle the removable drive. **DO NOT DROP IT.**
- Avoid exposing a hard drive to products with magnetic fields such as video and audio tape erasure products, monitors, and speakers.
- Do not spray the drive with cleaners or expose it to liquids.
- Avoid exposing the drive to temperature extremes.

- After removing a hard drive, place it into the hard drive carrying case. After removing a CD-ROM drive or diskette drive, place it into the MultiBay device carrying case. Do not use the MultiBay device carrying case to store or transport a hard drive.
- If a drive must be mailed, ship it in its carrying case wrapped in a bubble pack mailer or another suitable form of protective packaging. Shipping the drive in standard packaging may not cushion it from destructive shock, vibration, temperature, or humidity. Place a mailing label with the wording “Fragile: Handle With Care” on the mailer.

MultiBay Weight Saver

When no device is needed in the computer MultiBay, you can insert the MultiBay weight saver to reduce computer weight and to cover the MultiBay opening.

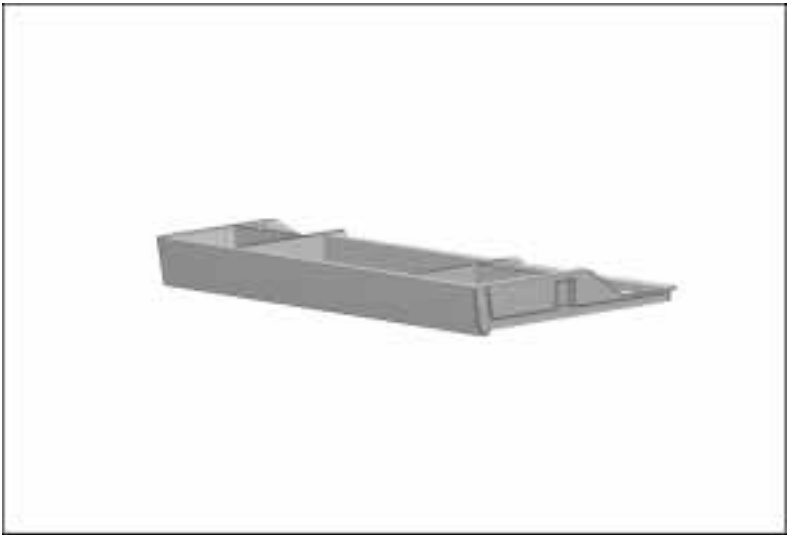

The MultiBay weight saver should not be used in the hard drive bay.

Hard Drives

Removing a Hard Drive from the Hard Drive Bay



CAUTION: To prevent damage to the computer and hard drive, and loss of information, turn off the computer before removing the hard drive from the hard drive bay. Do not remove the hard drive while the computer is turned on, in Suspend, or in Hibernation.

Electrostatic discharge can damage electronic components. Before touching the hard drive, ensure that you are discharged of static electricity by touching a grounded metal object.

- 1 Save your work, exit all applications, back up information on the hard drive, and shut down the computer.
- 2 Tilt the computer at an angle ❶ and slide the hard drive release latch ❷ on the bottom of the computer to the left while pulling on the notch under the hard drive.

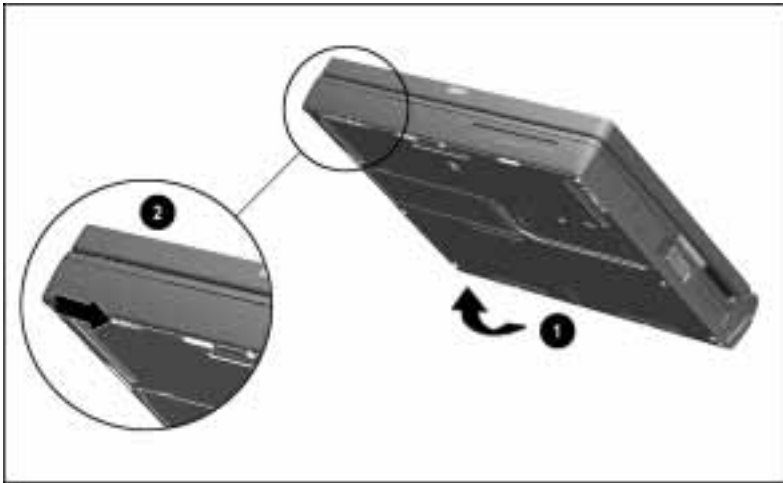

3 Remove the hard drive.



4 Grasp the drive by the metal edges and pull it out of the hard drive carrier.

5 Put the hard drive into the hard drive carrying case.

Inserting a Hard Drive into the Hard Drive Bay



CAUTION: To prevent damage to the computer and hard drive, and loss of information, turn off the computer before inserting the hard drive into the hard drive bay. Do not insert the hard drive while the computer is turned on, in Suspend, or in Hibernation.

Electrostatic discharge can damage electronic components. Before touching the hard drive, ensure that you are discharged of static electricity by touching a grounded metal object.

- 1 Turn off the computer.
- 2 Place the hard drive into the hard drive carrier. Be sure the tab is tucked under the hard drive.
- 3 Insert the hard drive, with the label facing up, into the hard drive bay until you hear a click.



Removing a Hard Drive from the MultiBay



CAUTION: To prevent damage to the computer and hard drive and loss of information, turn off the computer before removing a hard drive from the MultiBay. Do not remove the hard drive while the computer is turned on, in Suspend, or in Hibernation.

Electrostatic discharge can damage electronic components. Before touching the hard drive, ensure that you are discharged of static electricity by touching a grounded metal object.

- 1 Save your work, exit all applications, back up information on the hard drive, and shut down the computer.
- 2 Tilt the computer at an angle ❶ and slide the MultiBay release latch toward the rear of the computer to release the Hard Drive MultiBay Adapter ❷.

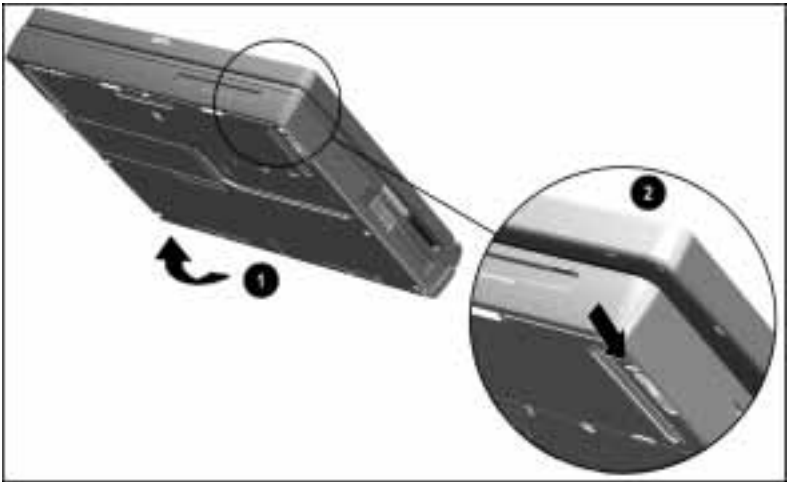

3 Remove the Hard Drive MultiBay Adapter.



4 Remove the hard drive from the Hard Drive MultiBay Adapter.

5 Put the hard drive into the hard drive carrying case.

Inserting a Hard Drive into the MultiBay



CAUTION: To prevent damage to the computer and hard drive and loss of information, turn off the computer before inserting a hard drive into the MultiBay. Do not insert the hard drive while the computer is turned on, in Suspend, or in Hibernation.

Electrostatic discharge can damage electronic components. Before touching the hard drive, ensure that you are discharged of static electricity by touching a grounded metal object.

- 1 Turn off the computer.
- 2 Insert the hard drive, with the label facing up, into the Hard Drive MultiBay Adapter.
- 3 Position the hard drive carrier against the left side of the MultiBay.
- 4 Slide the Hard Drive MultiBay Adapter into the MultiBay until it locks into place.



CD-ROM Drives

Removing a CD-ROM Drive from the MultiBay



CAUTION: To prevent damage to the computer and CD-ROM drive and loss of information, turn off the computer before removing a CD-ROM drive from the MultiBay. Do not remove the CD-ROM drive while the computer is turned on, in Suspend, or in Hibernation.

Electrostatic discharge can damage electronic components. Before touching the CD-ROM drive, ensure that you are discharged of static electricity by touching a grounded metal object.

- 1 Remove the compact disc from the CD-ROM drive.
- 2 Close the CD tray.
- 3 Turn off the computer.
- 4 Tilt the computer at an angle ❶ and slide the MultiBay release latch toward the rear of the computer to release the CD-ROM drive from the MultiBay ❷.

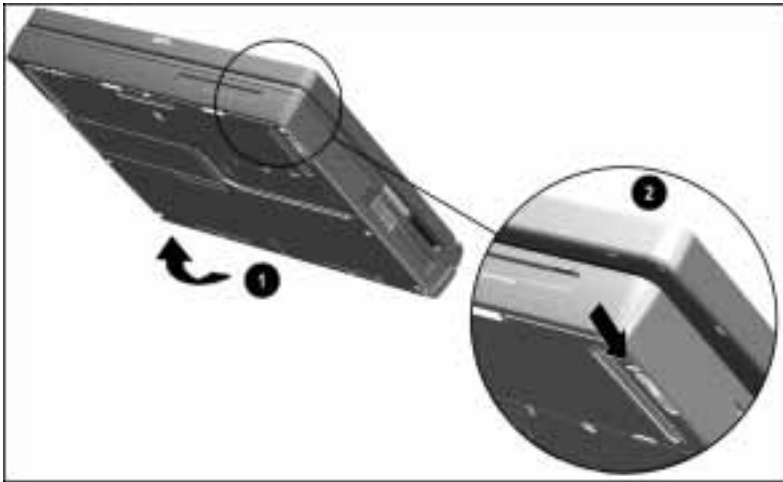

- 5 Pull out the CD-ROM drive and put it in the MultiBay device carrying case.



Inserting a CD-ROM Drive into the MultiBay



CAUTION: To prevent damage to the computer and CD-ROM drive and loss of information, turn off the computer before inserting a CD-ROM drive into the MultiBay. Do not insert the CD-ROM drive while the computer is turned on, in Suspend, or in Hibernation.

Electrostatic discharge can damage electronic components. Before touching the CD-ROM drive, ensure that you are discharged of static electricity by touching a grounded metal object.

- 1 Turn off the computer.
- 2 Position the CD-ROM drive, with the label facing up, against the left side of the MultiBay.
- 3 Slide the CD-ROM drive into the MultiBay until it locks into place.



Working with Compact Discs

Inserting a Compact Disc into the CD-ROM Drive

- 1 Turn on the computer.
- 2 Press the eject button on the bezel of the CD-ROM drive to release the CD loading tray.



- 3 Slowly pull out the CD loading tray until it is fully extended.
- 4 Remove the CD from its protective case and place it in the CD loading tray, label side up. Handle the CD by the edges, not by the flat surfaces.



5 Push lightly on the bezel of the CD loading tray to close it.

The light on the CD-ROM drive turns on while the CD is checked and the Table of Contents is being read. The light turns off when the CD-ROM drive is ready to receive commands.

Removing a Compact Disc from the CD-ROM Drive

- 1 Turn on the computer.
- 2 Press the eject button on the front panel to open the CD loading tray.



- 3 Slowly pull out the CD loading tray until it is fully extended.

- 4 Remove the CD from the tray. Handle the CD by the edges, not by the flat surfaces.



- 5 Place the CD in its protective case.
- 6 Push the front panel of the CD loading tray to close it.

Diskette Drives

Removing a Diskette Drive from the MultiBay



CAUTION: To prevent damage to the computer and diskette drive and loss of information, turn off the computer before removing a diskette drive from the MultiBay. Do not remove the diskette drive while the computer is turned on, in Suspend, or in Hibernation.

Electrostatic discharge can damage electronic components. Before touching the diskette drive, ensure that you are discharged of static electricity by touching a grounded metal object.

- 1 Remove the diskette from the diskette drive.
- 2 Turn off the computer.
- 3 Tilt the computer at an angle ❶ and slide the MultiBay release latch toward the rear of the computer to release the diskette drive from the MultiBay ❷.

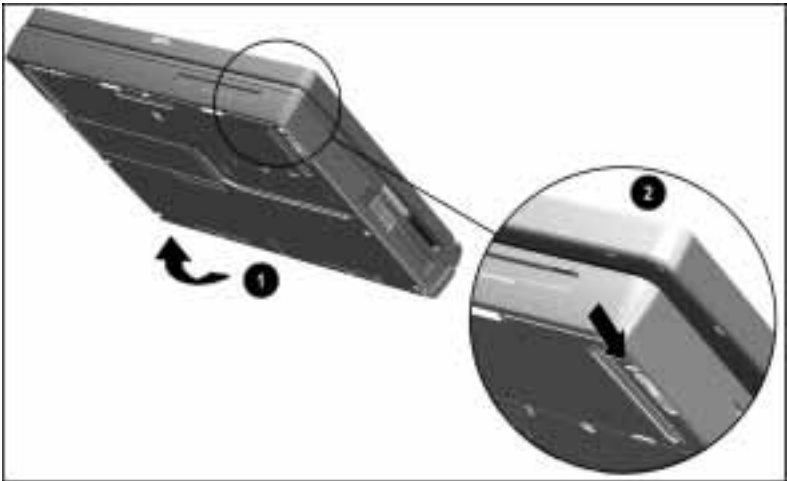

4 Pull out the diskette drive.



Inserting a Diskette Drive into the MultiBay



CAUTION: To prevent damage to the computer and diskette drive and loss of information, turn off the computer before inserting a diskette drive into the MultiBay. Do not insert the diskette drive while the computer is turned on, in Suspend, or in Hibernation.

Electrostatic discharge can damage electronic components. Before touching the diskette drive, ensure that you are discharged of static electricity by touching a grounded metal object.

- 1 Turn off the computer.
- 2 Position the diskette drive, label facing up, against the left side of the MultiBay.
- 3 Slide the diskette drive into the MultiBay until it locks into place.



Working with Diskettes

Selecting Diskettes

The diskette drive stores (writes) information to and reads information from a 3.5-inch diskette.

You can use the following diskette capacities: 1.44 megabytes, 720 kilobytes, 1.2 megabytes.

Diskette Capacity and Type	Storage Capacity in Text Pages
1.44-MB high-density (HD)	Approximately 250 full pages
1.2-MB high-density (HD) (Japan only)	Approximately 200 full pages
720-Kbyte double-density (DD)	Approximately 125 full pages

Inserting a Diskette into the Diskette Drive

Hold the diskette by the edge that contains the label. Insert the diskette, label facing up, into the diskette drive until it clicks into place.



If the diskette is inserted correctly, it drops into position in the diskette drive and the diskette drive button pops out.

Removing a Diskette from the Diskette Drive

- 1 Press the diskette drive button to eject the diskette.
- 2 Remove the diskette from the diskette drive.



Write-Protecting a Diskette

When a diskette is write-protected, the information stored on it can be read, but cannot be permanently changed.

Each 3.5-inch diskette has a sliding write-protect tab.

To write-protect a diskette, slide the tab on the corner of the diskette until the window is open.

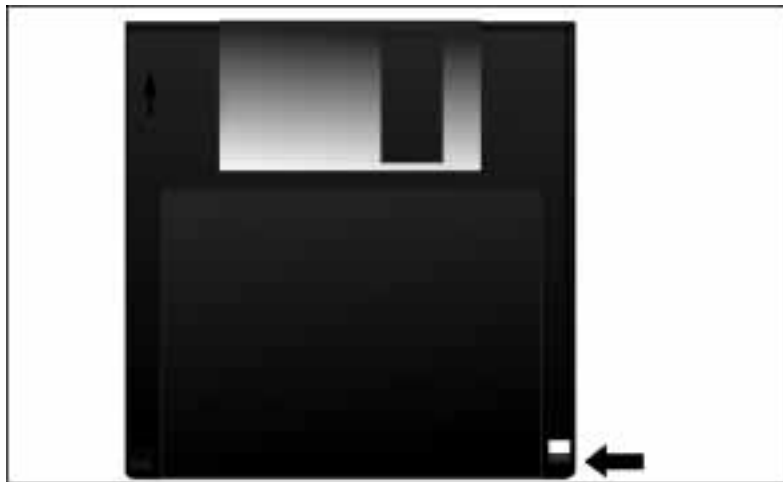

Before you use diskettes that come with a new software program, it is good practice to make backup copies and to write-protect the original diskettes.

Removing Write-Protection from a Diskette

To remove write-protection, slide the write-protect tab on the corner of the diskette to cover the hole.

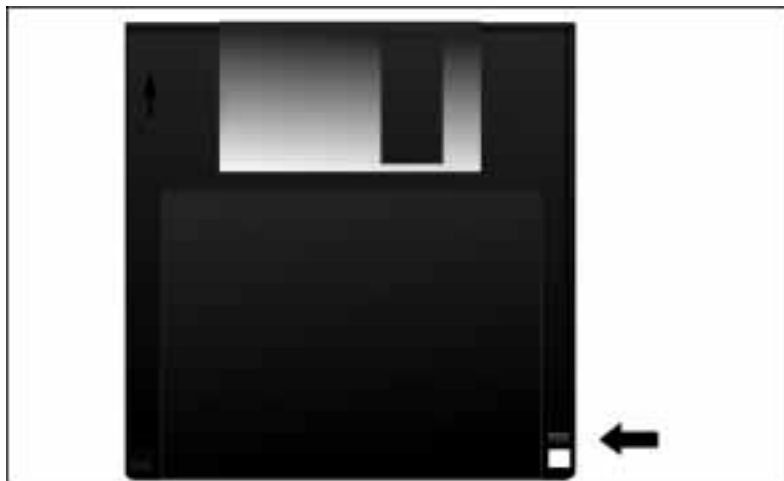

Removing write-protection from a diskette allows additional information to be stored (written) on the diskette.

chapter 7

USING THE INTERNAL MODEM

This chapter applies only to computers with internal modems.

Modem Basics

Understanding How a Modem Works

The modem serves two major functions:

- Data communications function—Sends information to and receives information from an online service, a host mainframe computer that provides electronic mail, and other personal computers.
- Facsimile (fax) communications function—Sends and receives text and images from facsimile (fax) machines and other computers.

After you set up your modem software, you are ready to start using your modem. You seldom need to use the AT command set if you are using communications and fax software because the modem will be controlled by the software. In the rare event that you do need to use the AT command set, you can access the information through the online *Reference Guide*. Go to the Commands menu at the top of any modem screen.

NOTE: The modem interfaces with Windows under Unimodem to provide data and fax capability to Windows-compatible applications. If you are running Windows 95, the modem also provides analog speakerphone functionality to TAPI-compliant applications.

Understanding Modem Software

Communications software operates the internal modem. This software issues commands to the modem such as the modem connection speed, the number of rings before answering the telephone, listening for a dial tone, or dialing a phone number.

You can use Windows HyperTerminal, communications software which comes with Windows 95 and Windows NT, to operate the modem in a variety of applications. For an explanation of how HyperTerminal works, refer to HyperTerminal's online help within the software.

To access Windows HyperTerminal, click Start → Programs → Accessories → HyperTerminal.

There is also a wide range of communications software available that can be used with this modem for tasks such as accessing your computer from a remote location. Contact your Compaq authorized dealer, reseller, or service provider for a complete list of communications software applications.

Editing and Executing a Command

If you make an error while typing a command, simply backspace over the mistake then retype. You cannot backspace over the AT prefix because it is interpreted immediately after it is typed.

To execute a command line, press the **Enter** key. (Pressing the **Enter** key processes the command line.)

Connecting the Modem

Connecting the Modem in North America, Latin America, Japan, or Hong Kong

The telephone connector (RJ-11) that came with your modem is intended for an analog line, the type found connected to a standard telephone wall jack. If you are in an office, the analog line is often the one connected to a fax machine or modem. To get an analog line in a hotel, request a room with a “data” line.

NOTE: The modem is equipped with Digital Line Guard, a feature that protects the modem if it is accidentally plugged into a digital PBX system with too much power on the line. If the modem is plugged into a digital line that might damage the modem, the following error message is displayed on the screen:

DIGITAL LINE NO DIALTONE

If the modem is plugged into a digital line that would not damage the modem, the modem times out and the following error message is displayed on the screen:

NO DIALTONE

NOTE: You do not have to turn the computer on or place it in Suspend to connect the modem.

To connect the modem to a standard telephone wall jack in North America, Latin America, Japan, or Hong Kong:

- 1 Connect the standard telephone cable into the RJ-11 jack on the rear panel of the computer.
- 2 Plug the opposite end of the telephone cable into a standard telephone wall jack.

Connecting the Modem in Europe, The Middle East, or Africa

IMPORTANT: The modem cable included with the computer is approved for a specific country. If you plan to travel with the computer, refer to “Using a Country-Specific Modem Cable,” the next section, for information about purchasing additional country-specific modem cables.

NOTE: If your computer was originally purchased in North America, Latin America, Japan, or Hong Kong, refer to “International Modem Adapter Requirements” later in this chapter.

NOTE: The modem is equipped with Digital Line Guard, a feature that protects the modem if it is accidentally plugged into a Digital PBX system with too much power on the line. If the modem is plugged into a digital line that might damage the modem, the following error message is displayed on the screen:

DIGITAL LINE NO DIALTONE

If the modem is plugged into a digital line that would not damage the modem, the modem times out and the following error message is displayed on the screen:

NO DIALTONE

NOTE: You do not have to turn the computer on or place it in Suspend to connect the modem.

To connect the modem to a standard telephone wall jack in Europe, the Middle East, or Africa:

- 1 Connect the country-specific modem to the 25-pin connector on the right side of the computer.
- 2 Connect the opposite end of the cable to a standard telephone wall jack.

Using a Country-Specific Modem Cable

When traveling, use the following international modem cables for approved connections in other countries.

NOTE: To ensure safe and reliable operation, use only UL LISTED modem cables.

Country	Part Number	Country	Part Number
Australia	234407-013	Luxembourg	234407-183
Austria	234407-343	Netherlands	234407-333
Belgium	234407-183	New Zealand	234407-AP3
Denmark	234407-083	Norway	234407-093
France	234407-053	Sweden	234407-103
Finland	234407-353	Switzerland	234407-113
Germany	234407-043	United Kingdom	234407-033
Japan	234407-293	United States	234407-003

International Modem Adapter Requirements

If you purchased the computer in North America, Latin America, Japan, or Hong Kong, the modem cable included with the computer can be used only in those locations.

For travel outside those locations, you need to purchase the International Modem Adapter, part number 248075-001, and the required country-specific modem cable (part numbers are listed earlier in this chapter).

The International Modem Adapter is not necessary for computers purchased outside of those locations.

For more information, contact your Compaq authorized dealer, reseller, or service provider.

NOTE: You do not need to turn the computer on or place it in Suspend to connect the modem.

- 1 Insert the International Modem Adapter into the 25-pin connector ❶.
- 2 Insert the modem connector end of the country-specific modem cable into the adapter ❷.

- 3 Plug the free end of the modem cable into the modem wall jack ③.

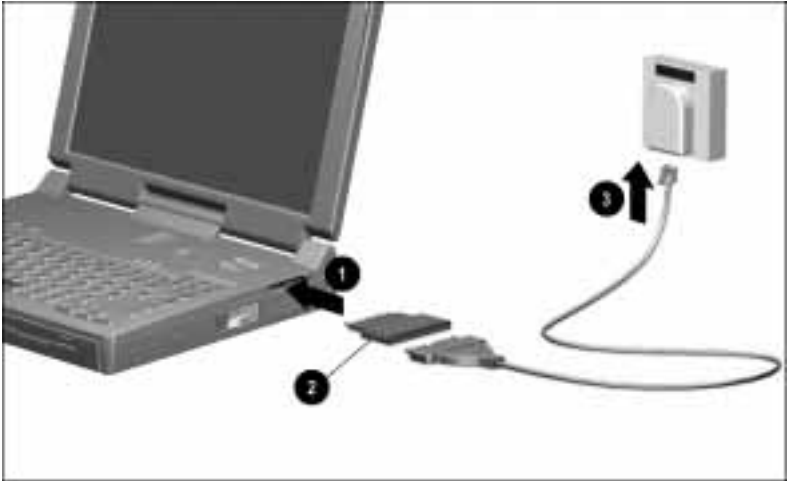

NOTE: The country-specific cable in this illustration is representative of this type cable. Connector size and wall jacks vary depending on country requirements.

Setting Modem Defaults

Some data and fax communications software prompts you for specific information about the modem model you are using. Select the Compaq Armada 7000 Series II Modem, or, if it is not available as a choice, select one of the following modems:

- Hayes Compatible
- COM2

NOTE: Choosing another modem will not affect the actual DCE speed of the modem.

If your software requires specific modem settings, the following information may be required when setting up the modem for operation:

COM port setting	COM2
DCE Speed	33.6 Kbps
DTE Speed	57.6 Kbps
Data Format	Databits - 8
Data Format	Parity - N
Data Format	Stopbits - 1
Dial Command	ATDT
AutoAnswer Command	ATS0 = 1
Sound	Enabled
Columns	80
Local Echo	Enabled

Setting S Register Default Values

The S register default values function reliably under most circumstances. However, these values may be modified if necessary.

For example, it may take an especially long time to get a dial tone in your office, so you may choose to reset S7 for a longer wait time.

Modifying an S Register

You can modify or change the value of an S register from command mode (terminal mode) or from a standard data or fax communication application. For example:

- Type **ATS11 = 70** then press **Enter**.

This sets S11 to a value of 70.

- If you then enter **AT = 95**, it resets S11 to a value of 95, since the modem remembered that S11 was the last register referenced.
- If you enter an **S =** command with no parameter (value), the register number defaults to zero and the modem changes the value of **S0**. Therefore, the following commands are equivalent: **ATS0 = 3** and **ATS = 3**.

Reading an S Register

To read the contents of a given S register in the terminal mode (command mode), type **ATSn?** (where n is the number of the register) then press **Enter**.

When modifying a register, the modem also remembers the location of the last inquiry. For example, the following sequence of commands display the contents of the S11 register.

ATS11? This command displays the value of S11.

AT? This command also displays the value of S11.

When you use an **S?** with no value, the register number defaults to zero and the modem responds with the value of S0 (for example **ATS?**).

Using Online Mode

In the online mode, the transmitting modem receives characters from the computer, converts the data to analog signals, then transmits these signals over the telephone line.

The process of altering a signal for transmission is called modulation. The receiving modem receives analog signals from the telephone when in the online mode and converts or demodulates the signal, returning it to the digital form that can be used by the computer.

NOTE: The word modem comes from the process of MODulation/DEMODulation.

Escaping from an Online Session to the Command Mode

Use the following steps to break out of a data transfer session (online mode) and return to command mode:

- 1 Press and hold the **Shift** key and type +++. An **OK** result code is displayed.

NOTE: The escape code sequence (+++) must be typed within one second, or as defined in the Escape Code Guard Time found in S12 register. You can access the S register set through the online *Reference Guide*. Access the Commands menu at the top of any modem screen.

- 2 Enter modem commands as needed.
- 3 Resume the online session by entering AT0 command or terminate the connection with the ATH0 command.

Creating a Command Mode Shortcut

An easy way to issue commands to the modem is via HyperTerminal, included with Windows 95 and Windows NT. You can create a shortcut for accessing HyperTerminal and sending commands to the modem. To create a command mode shortcut on the Windows desktop:

- 1 Create a Command Mode Icon.
- 2 From the HyperTerminal dialog box, click the Command icon.
- 3 Click File → Create Shortcut or click the right mouse button. A Command Mode Shortcut icon is displayed.
- 4 Click and drag the shortcut icon to the desktop.
- 5 To quit HyperTerminal, click File → Exit.

NOTE: To hang up the modem, type ATH0 and press **Enter**.

Creating a Command Mode Icon

To create a command mode icon using HyperTerminal:

- 1 Click Start → Programs → Accessories → HyperTerminal.
- 2 Double-click the Hypertrm.exe icon.
The Connection Description dialog box is displayed.
- 3 Type **Command** in the Name option.
- 4 Click OK.
The Phone Number dialog box is displayed.
- 5 Click Connect Using → Direct to Com 2.
- 6 Click OK.
The Modem Port Settings dialog box is displayed.
- 7 Click OK.

The command mode screen is displayed with a blinking cursor in the upper-left corner. Commands can now be sent to the modem, and the modem responds with a result code.

NOTE: To hang up the modem, type ATH0 and press **Enter**.

- 8 Click File, then Save to save the session.
- 9 Click File, then Exit to quit.
A command mode icon is displayed in the HyperTerminal dialog box.

Using the Modem with a Cellular Phone (United States Only)

Choosing Cellular Direct Components

You need to purchase the following items separately to make a cellular modem connection:

- One of the cellular phone models supported by this modem.
- Cellular phone connection cable.
(Contact your Compaq authorized reseller or service provider.)
- Cellular airtime.
(Contact a cellular carrier in your area.)

Connecting the Modem to a Cellular Phone



CAUTION: Using the wrong cellular phone cable could permanently damage the modem. Contact your Compaq authorized dealer, reseller, or service provider for information about purchasing a cable designed for this modem.

- 1 Turn off the computer.
- 2 Connect the 25-pin connector end of the cellular phone cable into the 25-pin connector ❶ on the right side of the computer.
- 3 Turn on the computer.
- 4 Insert the opposite end of the cellular phone cable into the connector of your cellular phone ❷. (Size and shape of connector varies depending on the cellular phone manufacturer.)



- 5 Turn on the cellular phone.

NOTE: The modem will not enter Suspend if it is registered with a data-ready cellular phone.

Registering the Phone with the Modem

NOTE: Use Windows HyperTerminal to enter command mode and register the phone with the modem.

If you want to use a cellular phone with the modem, use one of the following commands to register or set up the cellular phone with the modem.

- **\$M1** if you are using a Motorola, JVC, or Pioneer phone.
- **\$M2** if you are using a Nokia, Technophone, AT&T (selected models), or Tandy phone.

NOTE: **\$M3** is not supported by this modem

- **\$M4** if you are using a GE or Ericsson phone.

NOTE: You can also access the \$ command set through the *Online Reference Guide*. Select the Commands menu at the top of any modem screen.

This command needs to be issued only once; thereafter, the modem checks for the presence of the cellular phone. If a cellular phone is connected, the modem dials through the cellular phone; otherwise, it uses a standard (RJ-11) telephone connector.

NOTE: To modify this command, refer to “Using the &J Command (Telephone Interface Control)” later in this chapter.

Using PIN Dialing

Personal identification numbers (PIN) are issued by cellular airtime providers to protect customers against unauthorized calls.

From the data or fax communications application:

- 1 In the space provided for the phone number, type the 7-digit phone number **XXXXXXX** where **X** equals each digit of the phone number.
- 2 Type 3 commas (required delay to recognize PIN number) **,,,**
- 3 Type your 4-digit PIN number **XXXX** where **X** equals each digit of the PIN number.
- 4 Type an exclamation point dial modifier !
For example, **XXXXXXX,,,XXXX!**

PIN Dialing When Using a Stored Dial Suffix

You can use the stored dial suffix option in the data or fax communication application to automatically add your PIN number each time you make a call.

From the data or fax application:

- 1 In the space provided for the dial suffix, type 3 commas (required delay to recognize PIN number) **,,,**
- 2 Type your 4-digit PIN number **XXXX** where **X** equals each digit of the PIN number.
- 3 Type an exclamation point dial modifier !
For example **,,,XXXX!**

Modem Cellular Basics

To place data (sending information) calls, you can connect the modem to specific cellular phones with a cable. This makes the modem function exactly as it would if you were placing the call over a standard telephone line. For example, you can transfer information when you are mobile and a standard RJ-11 telephone jack is unavailable.

Since most modem software applications do not recognize that you are sending data from a cellular connection, you must use AT commands when transmitting or receiving data with a cellular phone. You can access the AT command set through the online *Reference Guide*. Use the Commands menu at the top of any modem screen.

Disabling Cellular Phone Recognition

NOTE: Use Windows HyperTerminal to enter command mode to disable cellular phone recognition.

You can disable cellular phone recognition by using the **\$M0** command. This command causes the modem to skip the process of detecting a cellular phone which occurs if **\$M1**, **\$M2**, or **\$M4** is entered.

Checking the Phone and Modem Connection

NOTE: Use Windows HyperTerminal to enter command mode to check the phone and modem connection.

Check the phone and modem connection by using the **AT\$** command.

After issuing the **AT\$** commands, you may see one of the following responses:

- If the connection is good, the modem displays the number of the cellular phone.
- If the connection is poor and you have previously registered the phone with the modem, the modem displays

PHONE DOES NOT RESPOND or **NO PHONE**

- If you have not previously registered the phone with the modem, the modem displays

NO PHONE NO PHONE

Checking Signal Strength

NOTE: Use Windows HyperTerminal to enter command mode and check the signal strength of the cellular phone connection.

You can use the **AT\$SI** command to check the cellular phone signal.

A cellular phone displays a standard Received Standard Signal Strength Index (RSSI) of between 80 and 255. If the RSSI falls below 80, make sure the phone is in an upright position and near a window. Do not place the phone down on a metal surface.

Using the &J Command (Telephone Interface Control)

After the **\$M1**, **\$M2**, or **\$M4** command has been issued, the modem checks for the presence of the cellular phone or noncellular connection depending on the setting of the **&J** command as follows:

&J0	This factory default setting performs autosense, whereby it detects the presence of a cellular phone or noncellular connection and dials accordingly. This process may take several seconds.
&J2	The modem will only dial over the noncellular connection, thus saving several seconds.
&J3	The modem will only dial over the cellular phone connection.

Power Management for a Cellular Connection

The modem will not enter Suspend if it is registered with a data-ready cellular phone.

How the Environment Affects Cellular Performance

Cellular data communications can be used from most locations where you are able to connect with a cellular phone. However, cellular networks were designed for voice communications and do not work as well for data communications. Due to the inherent nature of communication lines in a cellular environment, you must have different performance expectations for cellular data communications than for traditional noncellular communications.

Some characteristics encountered when sending data over cellular networks are:

- Noise
- Handoffs
- Dead spots and dropouts
- Bandwidth limitations
- Signal strength
- Network voice compression
- Low signal strength
- Unavailable channel
- Power-down requests
- Data bursts

Noise

Radio interference is common in metropolitan areas where cellular phones are prevalent. The interference includes other cellular users as well as electronic appliances and equipment.

Handoffs

As the mobile user changes cells, the signal strength on the channel drops, and the MTSO (Mobile Telephone Switching Office) may change (handoff) the user to a different cell and frequency where the signal is stronger. This handoff may interrupt the channel for 200 to 1200 milliseconds. A cell handoff may also occur even when stationary because of varying traffic loads.

Dead Spots and Dropouts

Dead spots are areas where cellular network radio signals cannot be received. Dropouts occur when the mobile user temporarily passes through an area (dead spot) where the radio signal is blocked or reduced.

Bandwidth Limitations

A large portion of the cellular voice channel is reserved for out-of-band signaling, therefore reducing the available bandwidth on the cellular network. Instead of having a flat response like the noncellular bandwidth, the cellular network processes the voice signal to improve quality. These bandwidth limitations can result in distortion and signal loss.

Signal Strength

Distance and obstacles can cause out-of-phase reflected signals that result in a loss of signal strength, resulting in the loss of an entire signal interval, or baud.

Network Voice Compression

On some networks, the link between the cell site and the MTSO (Mobile Telephone Switching Office) can employ compression techniques that work for voice, but can limit data transfer speed.

Low Signal Strength

Because of either distances or obstacles, the radio signal strength from a cell site may not be strong or stable enough to provide a reliable connection for either voice or data communications.

Unavailable Channel

No channel is available for use.

Power-Down Requests

To reduce interference between the variety of phones and to balance system traffic, the MTSO (Mobile Telephone Switching Office) may send a signal over the control channel commanding the phone to reduce its transmitting power. The modem may disconnect from the line due to this interruption of the link.

Data Bursts

The MTSO (Mobile Telephone Switching Office) may send messages to, or request information from, the phone on the voice channel while the audio link is established, resulting in a momentary disruption of data communications.

Using Windows or DSVD Application Software

NOTE: The following instructions apply when you are using modem drivers from Windows to communicate with the modem. If you are using a communications application other than Windows to initiate a DSVD call, refer to the software documentation for instructions on manually entering AT commands.

If you are running Windows:

- 1 Click Start → Settings → Control Panel → double-click Modems.
- 2 Click Properties from the General Tab.
- 3 Click Advanced from the Connection Tab.
- 4 In the Extra Settings option, type **AT-SSE=1-SSE-AC-SSE-FNS0=1**
- 5 Click OK → OK → Close to exit.

The command typed above has four parts:

- -SSE=1 enables DSVD operation.
- -SSE-AC tells the modem to automatically establish a DSVD session upon connection to another DSVD-enabled modem.
- -SSE-FN sets the modem to enable a full-duplex speakerphone operation after a DSVD connection occurs.
- SO=1 sets the modem to answer on the first incoming ring.

Using the Command Mode of Windows HyperTerminal

NOTE: To locate Windows HyperTerminal, click Start → Programs → Accessories → HyperTerminal.

Starting with a Voice Connection

From the command mode of Windows HyperTerminal, follow these instructions.

To initiate a voice call:

- 1 Type **AT-SSE=1** then press **Enter** to enable DSVD operation. The modem responds OK.
- 2 Type **AT+FCLASS=8;DTXXXXXXX** (where X = each digit of the phone number) then press **Enter**.
- 3 Type **ATD** then press **Enter** to enable DSVD mode.

NOTE: When -SSE=1 and speakerphone are active, the D command causes an automatic change from +FCLASS=8 to +FCLASS=0.

To answer a voice call:

- 1 Type **AT-SSE=1** then press **Enter** to enable DSVD operation. The modem responds OK.
- 2 If the modem is ringing, type **AT+FCLASS=8;+VLS** then press **Enter**. The modem is now in speakerphone mode and you can enter AT commands.
- 3 Type **ATD** then press **Enter** to enable DSVD mode.

NOTE: When -SSE=1 and speakerphone are active, the D command causes an automatic change from +FCLASS=8 to +FCLASS=0.

Starting with a Data Connection

From the command mode of Windows HyperTerminal, follow these instructions.

To initiate a data call:

- 1 Type **AT-SSE=1** then press **Enter** to enable DSVD operation. The modem responds OK.
- 2 Type **ATDTXXXXXXX** (where X = each digit of the phone number) then press **Enter**. The modem is now in data mode and you can enter AT commands.
- 3 Escape to Command Mode by typing **Shift+++** wait for OK.
- 4 Type **AT+VLS=7;O** then press **Enter** to enable DSVD mode.

NOTE: When -SSE=1 and speakerphone are active, the D command causes an automatic change from +FCLASS=8 to +FCLASS=0.

To answer a data call:

- 1 Type **AT-SSE=1** then press **Enter** to enable DSVD operation. The modem responds OK. The modem is now in data mode and you can enter AT commands.
- 2 If the modem is ringing, type **ATA** then press **Enter**. The modem is now in data mode and you can enter AT commands.
- 3 Escape to Command Mode by typing **Shift+++** then wait for OK.
- 4 Type **AT+VLS=7;O** then press **Enter** to enable DSVD mode.

NOTE: When -SSE=1 and speakerphone are active, the D command causes an automatic change from +FCLASS=8 to +FCLASS=0.

Changing from a DSVD Connection to a Data Connection

From the command mode of Windows HyperTerminal:

- 1 Escape to command mode by typing **Shift+++** then wait for OK.
- 2 Type **AT+VLS=0;O** then press **Enter**.
The modem responds OK and is now in data mode.

Changing from a DSVD Connection to a Speakerphone Connection

While in DSVD mode from Windows HyperTerminal:

- 1 Escape to command mode by typing **Shift+++** then wait for OK.
- 2 Type **AT+VNH=2;H** then press **Enter**.
The modem responds OK and is now in speakerphone mode.

NOTE: The H command automatically sets FCLASS=0.

chapter 8

USING THE INFRARED PORT

Infrared Connection Overview

Infrared-equipped computers are IrDA-compliant (4 Mbps standard). Infrared performance may vary depending on performance of infrared peripherals, distance between infrared devices, and applications used.

The infrared port allows wireless communication between your computer or a desktop expansion base and other infrared-equipped devices. Operating system support for infrared communication is currently available with Microsoft Windows 95. However, Microsoft Windows NT Workstation support for infrared communication is not available.

The infrared port produces an invisible beam of infrared light to communicate with another infrared-equipped device.

Establishing an Infrared Link

- Be sure the infrared ports on both computers are turned on and facing each other at a distance no greater than 1.5 feet (about 0.5 meter).
- Avoid moving the infrared ports away from each other during data transmission.
- Avoid interference from remote control units, such as wireless headphones or audio devices, pointed at the infrared ports.
- Avoid direct sunlight, fluorescent light, or flashing incandescent light close to the infrared ports.
- Keep the path between the infrared ports free of any objects that might interfere with data transmission.
- Do not point one of the ports more than 30 degrees (plus or minus 15 degrees off the center line) away from the infrared port of the device you are connecting with.



chapter 9

USING PC CARDS

Types of PC Cards

PC Cards are credit card-sized options designed to conform to the standard specifications of the Personal Computer Memory Card International Association (PCMCIA). Examples of PC Cards include memory expansion cards, diskette drive cards, fax/modem cards, and network interface cards. PC Cards are available in various types that indicate the thickness of the card. There are three PC Card types set by the PCMCIA:

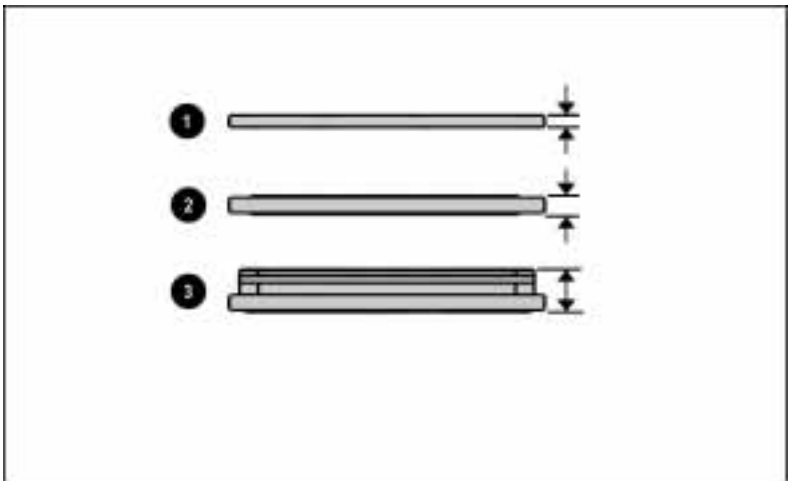

- ❶ Type I 3.3 mm
- ❷ Type II 5.0 mm
- ❸ Type III 10.5 mm

Type II and Type III PC Cards also come in extended PC Cards.

The computer supports the following 16-bit and CardBus (32-bit) PC Cards at the same time:

- Two Type I PC Cards
- Two Type II PC Cards
- One Type III PC Card
- One Type I and one Type II PC Card

The computer also supports several kinds of PC Cards, including network cards, hard drive cards, memory cards, and fax/modem cards. CardBus and 16-bit PC Cards can be used in either slot. Zoomed Video PC Cards can be used in the bottom slot.

NOTE: The computer can only interface with a network if a network PC Card is used or if it is docked in an optional desktop expansion base or convenience base.

Inserting a PC Card

- 1 If you are running Windows NT 4.0 without CardWare 5.0 from Compaq, turn off the computer.

NOTE: If you are running Windows 95, you do not need to turn off the computer or initiate Suspend before inserting a PC Card.

If you are running Windows NT and CardWare 5.0 from Compaq, insertion of the PC Card while the computer is on is supported for most PC Cards. Contact your PC Card vendor directly for information about the level of support they offer for “hot insertion” with CardWare 5.0.



CAUTION: To prevent damage to the connectors, use minimal pressure when inserting a PC Card into a PC Card slot.

- 2 With the label side up, insert the 68-pin connector side of the PC Card into the slot, pushing gently.

NOTE: The PC Card slot contains two guide rails. Until you become familiar with slot positions, look inside the PC Card slot before inserting the PC Card. When a PC Card is inserted correctly, you can feel it seat itself.

IMPORTANT: Before a new PC Card can be used, it may be necessary to perform an initial setup procedure. Follow the PC Card manufacturer’s instructions for installing the needed card-specific device drivers.



If you are running Windows 95 and your computer is on, the computer automatically configures a Plug and Play card and most other PC Cards. If the computer is turned off or in Suspend, a card is not configured until you turn on the computer or exit Suspend.

Windows NT is not Plug and Play. If you are running Windows NT, the computer configures a card only when it is in the PC Card slot when the computer is turned on. The computer only recognizes that a PC Card has been removed if the card is out of the slot when the computer is turned on.

For information about each PC Card you use, access its online PC Card help.

Removing a PC Card

- 1 If you are running Windows 95, stop the PC Card. You do not need to turn the computer off or initiate Suspend.



CAUTION: Failure to stop a PC Card before it is removed may damage the PC Card or computer.

If you are running Windows NT, turn off the computer.

- 2 Pull on the PC Card eject lever(s) ① .
- 3 Remove the PC Card ② .

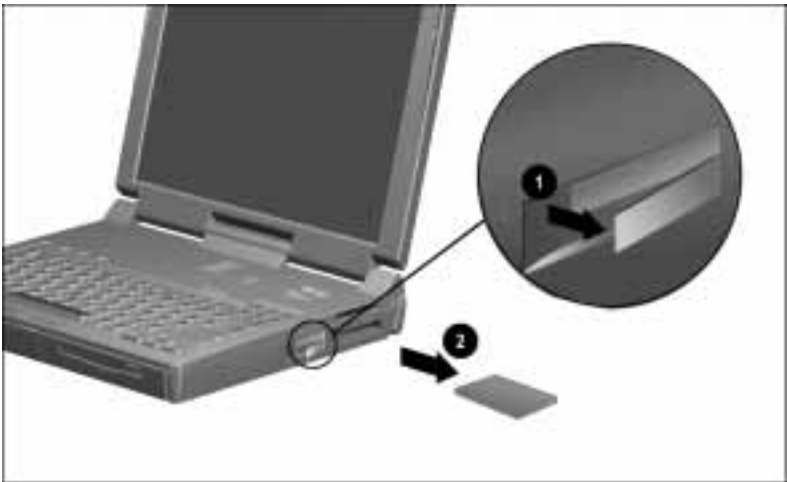

- 4 Push the PC Card eject lever(s) back into place.

NOTE: If you are running Windows 95, the computer beeps twice if it is turned on when the PC Card is removed.

Stopping a PC Card

If you are running Windows 95, you should always stop a PC Card before removing it from a PC Card slot. To stop a PC Card:

- 1 Click the PC Card icon in the notification area on the taskbar. A list of PC Cards in the system appears.
- 2 Click the PC Card that you want to stop.
IMPORTANT: Always stop a LAN, ATA, or SCSI card before removing.
- 3 Remove the PC Card when the message appears that it is safe to remove the card.

PC Card Device Drivers

Device drivers are programs or data files containing information needed to run a specific PC Card. Most of the device drivers you need are preinstalled on the computer.

NOTE: In order to save available memory, some device drivers are not enabled after being installed.

Some types of PC Cards, such as network cards, Global Positioning System (GPS) cards, SCSI cards, audio cards, and multifunction cards, require an additional PC Card-specific software device driver to function properly. This software device driver is provided on diskette by the PC Card manufacturer and should be installed according to the manufacturer's instructions. Do not install any other PC Card software on the computer such as Card and Socket Services, even if prompted to do so.



CAUTION: Compaq has tested the PC Card software preinstalled on the computer. If you install Card and Socket Services or enablers provided by other vendors over software preinstalled on the computer, the computer may no longer work properly with all of your PC Cards.

Zoomed Video

A Zoomed Video PC Card is a PC Card that creates a direct path from the system PC Card controller to the graphics controller in the computer. This allows multimedia devices to send and receive information without using the system bus. A Zoomed Video PC Card promotes higher overall system performance for MPEG playback.

The computer supports Zoomed Video PC Cards under Windows 95. Windows NT does not support Zoomed Video.

Always insert a Zoomed Video card into the bottom PC Card slot.



chapter 10

USING AUDIO FEATURES

Introducing the Audio Components

The computer provides both internal and external audio capabilities. You can record and play sound, enhance an interactive demonstration with high-quality stereo sound, and take advantage of business programs, presentations, and multimedia educational and entertainment software.

The internal microphone supports audio input for spoken comments. An external electret condenser microphone can also be used to record voice or sound.

The integrated stereo speakers support sound output for WAV file and MIDI playback, and audio from the CD-ROM drive. They also support external audio input devices such as a CD player, tape deck, or stereo tuner connected to the computer through the stereo line-in jack. Headphones or external speakers can be connected to the computer through the stereo speaker/headphone jack.

Using Internal and External Microphones

The internal microphone is accessible even when the display is closed.

The internal microphone is disabled when an electret condenser microphone with a 3.5-mm plug is plugged into the external mono microphone jack.



IMPORTANT: A mono electret condenser microphone in the mono microphone jack is acceptable, but the left channel will be recorded on both the left and right channels. A dynamic microphone will not achieve the recommended sensitivity.

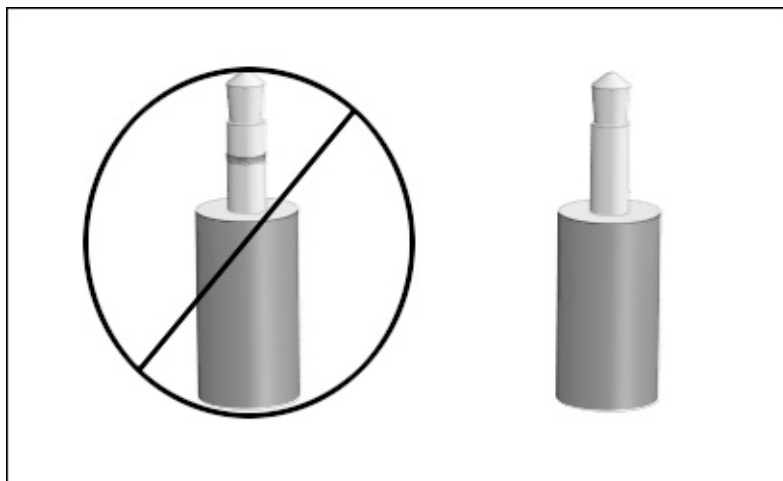

Using Internal and External Speakers

Internal Speakers

The internal stereo speakers are disabled when external speakers or headphones are connected to the stereo speaker/headphone jack



External Speakers

- Provide more separation for the left and right audio channels.
- Produce more volume with amplified speakers.
- Produce higher quality sound.



CAUTION: Use only a 3.5-mm stereo plug in the stereo speaker/headphone jack. A mono plug can result in damage to the computer.

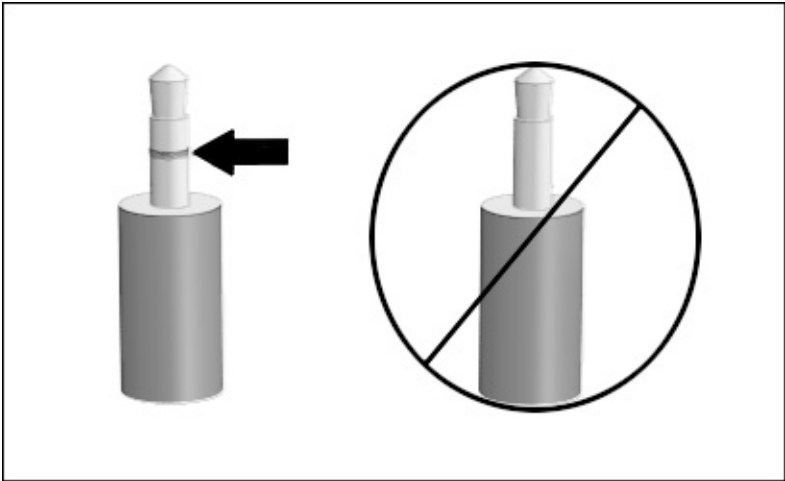

Identifying Audio Connections

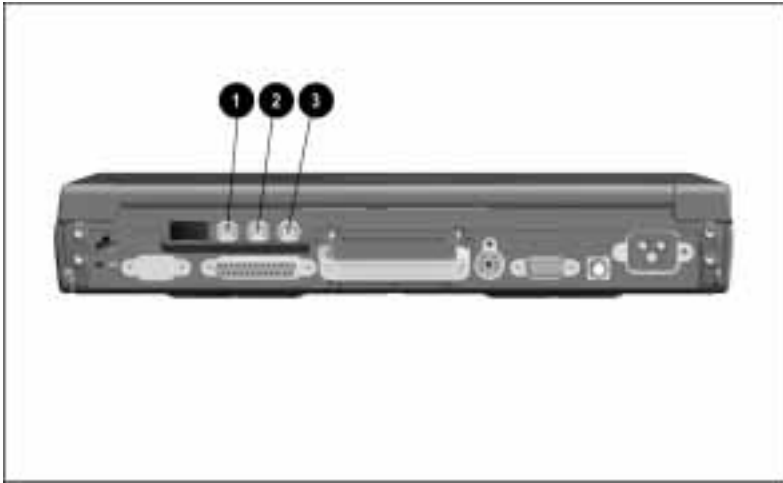

Audio Connections

Connection	Function
① Mono microphone jack	Connects an external monophonic microphone.
② Stereo speaker/headphone jack	Connects stereo headphones or external stereo speakers to the computer. This jack is driven by an amplifier and has volume control. The internal computer speakers are turned off when external speakers are plugged into this jack.
③ Stereo line-in jack	Connects a CD player, tuner, or tape deck to the computer.

IMPORTANT: A mono electret condenser microphone is recommended. Plugging a stereo microphone in the mono microphone jack is acceptable, but the left channel will be recorded on both the left and right channels. A dynamic microphone will not achieve the recommended sensitivity.



CAUTION: Use only a 3.5-mm stereo plug in the stereo speaker/headphone jack. A mono plug can result in damage to the computer.

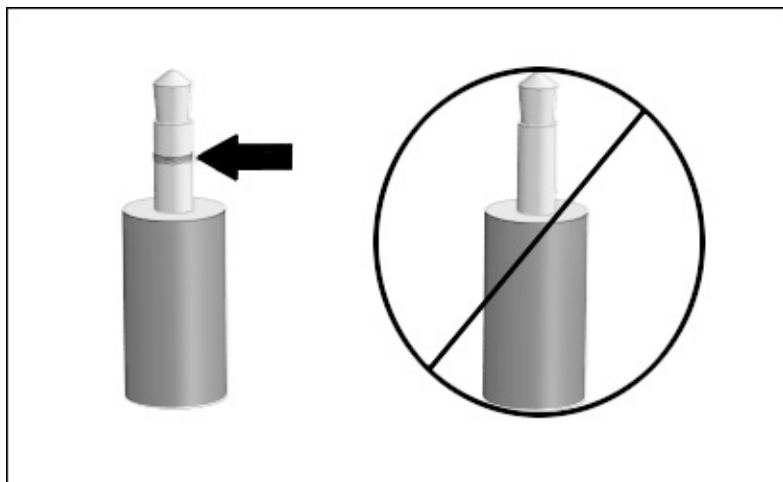

Controlling Audio Volume



WARNING: To reduce the risk of personal injury to hearing, check the volume level of software applications before you put on headphones.

Controlling the audio volume affects the stereo speakers and headphones or external speakers that are connected to the stereo speaker/headphone jack. Volume controls also affect the stereo speakers in the optional desktop expansion base.

There are three ways to control the audio volume:

- The volume control on the top right side of the computer. To mute sound completely, press both volume buttons simultaneously.
- The volume control features available from the Audio tab in MultiMedia Properties.
- The **Fn+F5** hotkeys (adjust the volume of system warning beeps).

Some software applications, such as game programs, include their own volume controls. You may need to adjust the volume controls to get the desired sound levels.

The volume control on the computer overrides all other volume controls in the software. That is, the volume from the integrated stereo speakers, external speakers, or headphones will never be louder than the sound level selected using the computer volume control.



chapter 11

UPGRADING RAM MEMORY

Increasing RAM

You can expand random access memory (RAM) by adding a memory expansion board and also by replacing a preinstalled memory expansion board. For example, you can expand RAM by installing two 64-megabyte memory expansion boards.

To view the amount of existing RAM in the computer, click Start → Settings → Control Panel → double-click the Compaq Diagnostics icon.



WARNING: The memory compartment is the only user-accessible internal compartment on the computer. All other areas that require a tool to access should be opened only by a Compaq authorized service provider.

IMPORTANT: When RAM is increased, the space on the hard disk reserved for the Hibernation file is also increased. If you experience problems with Hibernation after adding a memory expansion board, verify that your hard disk has enough free space for the larger Hibernation file.

To view the amount of free space on your hard disk, click Start → Settings → Control Panel → double-click the Power icon → Hibernation tab.

Obtaining an Optional Memory Expansion Board

For a list of the memory expansion boards available for the computer:

- Refer to the accessories flier that came with the computer.
- Refer to the online *Options Catalog* by clicking Start → Compaq Information Center → *Options Catalog*.
- Refer to “Worldwide Telephone Numbers” in Appendix A for the nearest Compaq authorized dealer, reseller, or service provider.

IMPORTANT: The computer only supports SDRAM (synchronous DRAM) memory expansion boards. If you install a different type of memory expansion board, you will receive the following message when you restart the computer:

This unit only supports SDRAM.

If you receive this message, turn the computer off and remove the memory expansion boards.

Removing a Memory Expansion Slot Cover

On a model that ships with a preinstalled memory expansion board, the memory expansion slot cover is secured with a tamper-resistant memory expansion slot cover security screw. Use the Torx T-10 screwdriver included with the computer to remove and reinsert this screw.

On a model that ships with an empty memory expansion compartment, the memory expansion slot cover is attached with a standard Torx T-8 screw. Use a standard Torx T-8 screwdriver to remove and reinsert this screw.

Two memory expansion slot cover security screws are included with the computer. The factory-installed Torx T-8 screw can be replaced with a security screw.

To remove the memory expansion slot cover:



CAUTION: Electrostatic discharge (ESD) can damage electronic components. Before beginning this procedure, ensure that you are properly grounded.

- 1 Save your work, exit all applications, and shut down the computer.

NOTE: If you are unsure whether the computer is off or in Hibernation, turn the computer on, then shut it down.



WARNING: Failure to unplug the power cord and remove the battery pack before installing a memory expansion board can damage the equipment and expose you to the risk of electrical shock.

- 2 Disconnect all external devices connected to the computer.
- 3 Disconnect the power cord.
- 4 Remove the battery pack(s) from the computer.
- 5 Turn the computer upside down on a flat surface with the rear panel facing you.

- 6 Remove the screw ❶ securing the memory expansion slot cover to the computer.
- 7 Slide right, then lift away the memory expansion slot cover ❷.

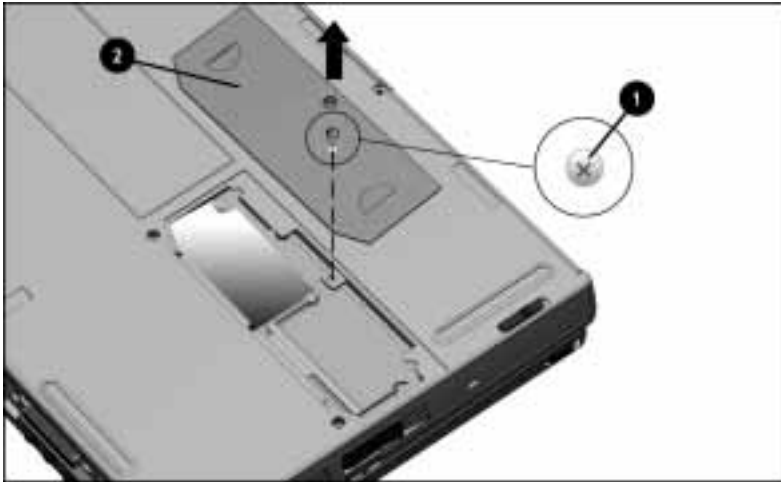

Removing a Memory Expansion Board

- 1 Lift and hold back the memory insulator ❶.
- 2 Pull away the plastic retention clips on each side of the memory expansion board to release it ❷. The memory expansion board tilts toward you.
- 3 Lift the edge of the memory expansion board and slide it gently out of the memory expansion slot at a 45-degree angle ❸.



- 4 Place the removed memory expansion board in an electrostatic-safe container.

Inserting a Memory Expansion Board

A memory expansion board is asymmetrically keyed (notched) to ensure correct positioning.

- 1 Insert the memory expansion board into an empty memory expansion slot at a 45-degree angle ❶. Then slide it gently into place until it is seated while tilted.
- 2 Push the memory expansion board down until the plastic retention clips ❷ snap back into place.

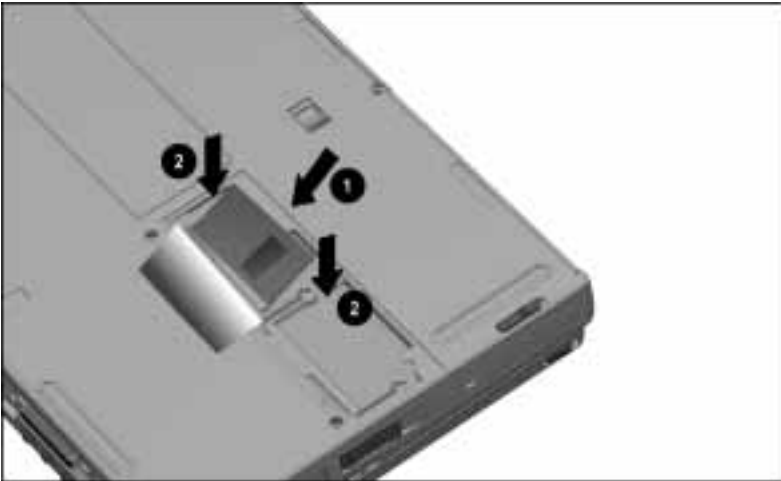

Replacing the Memory Expansion Slot Cover

- 1 Lay the memory insulator **1** over the installed memory expansion board(s), ensuring that all edges of the memory insulator are tucked inside the memory expansion compartment.
- 2 Replace the memory expansion slot cover **2** by placing it flush right over the memory expansion compartment, then sliding it left until it is seated.
- 3 Secure the memory expansion slot cover with a memory expansion slot cover security screw **3** or a standard Torx T-8 screw.

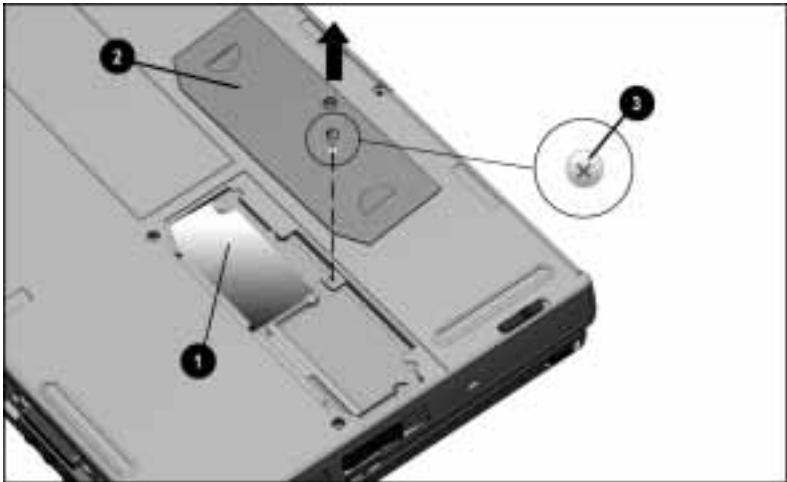



chapter 12

MAINTENANCE AND TRAVEL GUIDELINES

Caring for the Computer

Keep the computer in good condition and working properly by following these guidelines:

- Keep the computer away from excessive moisture and temperature extremes. Do not expose the computer to liquids or precipitation.
- Remove the battery pack from the computer if the computer will not be used for more than two weeks. Store the battery pack in a cool, dry place.
- To prevent possible damage to the display, do not place anything on top of the computer when it is closed.
- Occasionally wipe the exterior of the computer and the screen with a soft, damp cloth moistened only with water. Using soap or other cleaning products may discolor the finish and damage the screen.



WARNING: Do not spray liquid directly on the computer screen. Excess liquid may drip inside the computer and damage the components or result in electrical shock.

Replacing the Pointing Device Rubber Cap

- 1 Shut down the computer by clicking Start → Shut Down or exit all applications.
- 2 Gently pull off the rubber cap.
NOTE: If the plastic cap underneath the rubber cap comes off, gently push it back on.
- 3 Gently push on the new rubber cap.



Cleaning the Screen

Wipe the screen occasionally with a soft, damp cloth moistened only with water.



WARNING: Do not spray any type of cleaning fluid directly on the computer screen. Excess liquid may drip inside the computer and damage the components or result in electrical shock.

Operating Temperatures

The computer is designed to run demanding applications that require PC Cards, CD-ROM drives, and large amounts of RAM while maintaining full processor performance.

As a result of increased power consumption, it is normal for the computer to feel warm to hot when being used for extended periods.

The computer complies with international safety standards for temperatures of user accessible surfaces.

Traveling With the Computer

For safety and convenience when traveling, follow these guidelines:

- Safeguard your data before you leave on a trip by making a backup copy.
- Take an extra backup copy of the data with you.
- Remove a diskette from the diskette drive.
- Remove a CD from the CD-ROM drive.
- Disconnect external equipment from the computer.
- Hand-carry the computer in a briefcase. Do not check the computer with your luggage.

IMPORTANT: There are three types of airport security devices: X-ray machines (the conveyor belt device you set your bags on), magnetic detectors (the device you walk through), and security magnetic wands (the hand-held device used by security personnel). You can send your computer and diskettes through airport X-ray machines. However, Compaq recommends that you do not send your computer and diskettes through airport magnetic detectors or expose them to security magnetic wands.

- Check with the airline if you plan to use the computer on the plane. In-flight computer use is at the discretion of the airline.
- Before traveling internationally with the computer:
 - Check local customs regulations for restrictions and requirements on traveling with your computer.
 - Purchase (from a Compaq authorized dealer, reseller, or service provider) a power cord for the country where you will be using the computer. These power cords are designed to meet the voltage and frequency requirements of each country.



CAUTION: Do not use the converter kits sold for appliances to power the computer.

Shipping the Computer

Follow these steps when shipping the computer:

- 1 Back up your data. Do not expose your backups to electrical or magnetic impulses while stored or in transit.
- 2 If there is a diskette or compact disc in a drive, remove it.
- 3 Turn off the computer and external devices.
- 4 Close the computer.
- 5 Disconnect external equipment from the computer.
- 6 Close the connector cover and all exterior doors.
- 7 Pack the computer and external devices in their original packing boxes, or in similar packaging with sufficient packing material to protect them and prevent shifting or movement in transit.



chapter 13

SECURITY FEATURES

Types of Security

Numerous security features protect the computer and the information stored on it from unauthorized access.

- **Power-On Password**

Prevents unauthorized use of the computer when it is turned on, restarted, or resumed from Suspend or Hibernation.

- **Setup Password**

Prevents unauthorized users from changing your computer configuration through Computer Setup. May also be used by network administrators to protect and access the configuration of computers in a network.

- **QuickLock/QuickBlank**

Clears the screen and disables the keyboard and other input devices while the computer is running.

- **DriveLock**

Prevents unauthorized use of the hard drive when the computer is turned on, restarted, or resumed from Hibernation. Stops an unauthorized user from using your hard drive.

- **Login Password (Windows NT only)**

Used to log in to Windows NT. When combined with the security features above, prevents unauthorized users from accessing your hard drive. Windows NT has a multiple boot menu, which can allow users to boot up Windows 3.1 or Windows 95 and thereby bypass Windows NT security.

- **Disabling devices through Computer Setup**
Prevents unauthorized use of specified computer components.
- **Memory compartment cover security screw**
Helps prevent unauthorized removal of memory expansion boards.
- **Single-bay security screw**
Secures either the hard drive or the MultiBay.
- **Dual-bay security screw**
Secures both the hard drive and the MultiBay.
- **Cable lock provision**
Provides a way to secure the computer, optional desktop expansion base, or optional convenience base to a fixed object.

Power-On Password

Setting the Power-On Password Using Windows 95

The power-on password prevents unauthorized use of the computer when it is turned on or resumed from Suspend or Hibernation.

- 1 Click Start → Settings → Control Panel → double-click Passwords → Passwords Properties.

- 2 Click on the Computer Security tab.

- 3 Click the Set button.

NOTE: Type carefully because the password does not display as you type it.

- 4 Enter your password twice.

- 5 Click OK.

The password is not case sensitive. However, you must use the same keys each time you enter the password. For example, the numbers at the top of the keyboard are not recognized as being the same numbers in the embedded numeric keypad.

After you set the power-on password, you must enter it each time you turn on the computer or resume from Suspend or QuickLock/QuickBlank.

Setting the Power-On Password Using Windows NT

The power-on password prevents unauthorized use of the computer when it is turned on or resumed from Suspend or Hibernation.

- 1 Run Computer Setup.
- 2 Click the System Features icon → Security Management menu.
- 3 Under Power-On Password, click Set.
- 4 Enter your new power-on password. (You can use up to eight alphanumeric characters, and you can use the same password you are using for the setup password.)
- 5 Enter the password again to verify it.
- 6 If you want to require entry of a password whenever the computer is turned on, enter an **X** next to Enable Password to Power-On.
- 7 Click OK → Exit → Save.

Once the power-on password is set, you must enter it every time you turn on the computer or resume from Hibernation, Suspend, or QuickLock/QuickBlank.

Entering the Power-On Password

- 1 Turn on or restart the computer.
- 2 Type your power-on password at the password prompt.
- 3 Press **Enter**.

If you type the password incorrectly, you are prompted to reenter it up to three times.

Changing the Power-On Password

You can change the password using the computer keyboard. The syntax for changing the password varies according to the language of your keyboard. Refer to “Change/Delete Password Symbols” later in this chapter for the proper syntax.

- 1 Turn on or restart the computer.
- 2 Type your current password at the password prompt, then type the new password in the following format:

current password, keyboard password symbol, new password, keyboard password symbol, new password
- 3 Press **Enter**.

Deleting the Power-On Password

You can delete the password using the computer keyboard. The syntax for deleting the password varies according to the language of your keyboard. Refer to “Change/Delete Password Symbols” later in this chapter for the proper syntax.

- 1 Turn on or restart the computer.
- 2 Type your current password at the password prompt, then type the keyboard password symbol.
- 3 Press **Enter**.

If You Forget Your Password



CAUTION: If you forget your password, the computer must be disassembled, the memory cleared, and the computer reassembled.

Contact your Compaq authorized dealer, reseller, or service provider for assistance.

Setup Password

Setting the Setup Password

The setup password prevents unauthorized users from changing your computer configuration through Computer Setup.

Setup passwords can also be used by the network administrator to protect and access the configuration of computers in a network.

NOTE: After you establish the setup password, you must enter it each time you want to change the computer configuration.



CAUTION: You cannot change the computer configuration if you forget your setup password. Record the password and put it in a safe place.

- 1 Run Computer Setup.
- 2 Click the System Features icon → Security Management box.
- 3 Under the Setup Password section, Passwords tab, click Set.
- 4 Enter your new setup password. (You may use up to eight alphanumeric characters, and you may use the same password you are using for the power-on password.)

NOTE: Type carefully because the password does not display as you type it.

- 5 Enter the password again to verify it.
- 6 Click OK → Exit → Save.

You will be prompted to enter your setup password the next time you try to change the computer configuration using Computer Setup.

Entering the Setup Password

After you set the setup password, you must enter it each time you want to change the computer configuration.

- 1 Turn on or restart the computer.
- 2 When the cursor moves to the upper right corner of the screen, press **F10**.
- 3 Enter your setup password at the password prompt.
- 4 Press Enter.

NOTE: You can use the setup password for both setup and power-on passwords.

Changing the Setup Password



CAUTION: You cannot change the computer configuration if you forget your setup password. Record the password and put it in a safe place.

Once you create a setup password, you can only change the password after the computer has restarted and you are prompted to enter the current setup password.

To change your password, type in the old password, then enter the new password twice, typing the syntax for your computer keyboard between the passwords. Refer to “Change/Delete Password Symbols” later in this chapter for the correct syntax.

For example, if you have a Belgian keyboard, type the following:

current password=new password=new password

The new password takes effect the next time you turn on your computer.

Deleting the Setup Password

Press **F10** to get to Computer Setup and you are prompted to enter the current setup password.

You can delete the password using the computer keyboard. The syntax for deleting the password varies according to the language of your keyboard.

- 1 Turn on or restart the computer.
- 2 When the cursor moves to the upper right corner of the screen, press **F10**.
- 3 Type your setup password at the setup password prompt, then type the keyboard password symbol. Refer to “Change/Delete Password Symbols” later in this chapter for the correct password symbol.
- 4 Press **Enter**.

Change/Delete Password Symbols

Once you create a setup or power-on password, you can only delete that password after the computer has restarted and you are prompted to enter the current password.

Once you have entered the current setup or power-on password, you can change or delete that password using the computer keyboard. The syntax for changing or deleting the setup or power-on password varies according to the language of the keyboard purchased with the computer.

The following is the list of countries and keyboard symbols for changing or deleting the setup and power-on passwords.

Country Keyboard	Keyboard Symbol
Belgian	= (equals)
Danish, German, Italian, Latin American, Norwegian, Portuguese, Spanish, Swedish/Finnish, Swiss, Taiwanese	— (em dash)
French	! (exclamation)
French/Canadian	é (eacute)
Japanese	\ (backslash)
Korean, United Kingdom, United States	/ (slash)

Using the Quick Controls

The Quick Controls establish security measures on your computer when it is on but not in use. They are located in Passwords Properties.

To go to Passwords Properties, click Start → Settings → Control Panel → double-click Passwords → Passwords Properties.

- QuickLock disables your keyboard and pointing device while the computer is running. It leaves your information on the screen but prevents it from being accessed until a power-on password is entered to enable the keyboard.
- QuickBlank, used in conjunction with QuickLock, clears the screen when the keyboard and pointing device are disabled.
- QuickLock on Suspend automatically disables the keyboard and pointing device when the computer enters Suspend. It prevents your information from being accessed until a power-on password is entered. Entering the password allows the computer to exit Suspend and enables the keyboard and pointing device.

Enabling and Disabling QuickLock/QuickBlank Using Windows 95

QuickLock/QuickBlank must be enabled using Password Properties before you can initiate the QuickLock/QuickBlank feature with the Fn+F6 hotkeys. QuickLock/QuickBlank remains enabled until you disable it.

To enable or disable QuickLock/QuickBlank:

- 1 Access Passwords Properties.
- 2 Click on the Computer Security tab.
- 3 Under the Quick Controls section, click in the box to enable/disable QuickLock, QuickBlank, or QuickLock on Suspend. An **X** in the box indicates that QuickLock/QuickBlank is enabled.

Enabling and Disabling QuickLock/QuickBlank Using Windows NT

QuickLock/QuickBlank must be enabled using Computer Setup before you can initiate the QuickLock/QuickBlank feature with the **Fn+F6** hotkeys. QuickLock/QuickBlank remains enabled until you disable it.

- 1 Run Computer Setup.
- 2 Click the System Features icon → Security Management menu → Password Options tab → Enable QuickLock → OK → Exit → Save.

DriveLock Overview

DriveLock security prevents unauthorized access to hard drive applications and user data. DriveLock sets a user password and a master password for each removable hard drive in the computer. The correct user password must be entered when the computer is turned on before a protected hard drive can be accessed. Protected hard drives remain protected even if removed and inserted into another computer.

NOTE: DriveLock password protects or unlocks the computer hard drive(s) only when inserted into either the hard drive bay or the MultiBay. You cannot use DriveLock to protect a hard drive in the desktop expansion base or convenience base. If you place a protected hard drive into a desktop expansion base or convenience base MultiBay, it will remain locked and cannot be accessed.

After you enable DriveLock, you must enter the user password each time you turn on or restart the computer or resume from Hibernation.

When the DriveLock password prompt displays, enter your user password.

If you type the user password incorrectly, you are prompted to reenter it up to two times. After two unsuccessful attempts to unlock a protected hard drive, it will be necessary to restart the computer.

User and Master Passwords Overview

The user password is the password primarily used when turning on the computer. It prevents unauthorized users from gaining access to your removable hard drive. The owner of the user password should be the day-to-day user of the hard drive, not a system administrator.

NOTE: After you establish the user password, you must enter it each time you want to access your removable hard drive(s). This password will be required even if the hard drive is inserted into another computer. If the correct password is not entered, the hard drive will remain locked and inaccessible.

The master password is used to remove DriveLock protection and to gain access to the hard drive instead of the user password. The owner of the master password may be the system administrator.



CAUTION: Forgetting or losing both the user and master passwords will render the protected hard drive permanently unusable. Record your master password and keep it in a secure location physically separate from your computer. In the event you lose the user password, the master password can be used to unlock a protected hard drive and reset the user password.

NOTE: If you forget your user or master password, contact Compaq customer support for further instructions before proceeding.

Establishing DriveLock Protection



CAUTION: Forgetting or losing both the user and master passwords will render the protected hard drive permanently unusable. Record your master password and keep it in a secure location physically separate from your computer. In the event you lose the user password, the master password can be used to unlock a protected hard drive and reset the user password.

To establish DriveLock protection:

- 1 Run Computer Setup.
- 2 Click the System Features icon → Security Management box → DriveLock tab.
- 3 In the Current Drive section, select either Armada hard drive bay or Armada MultiBay.
- 4 In the Drive Protection section, click Set to establish DriveLock protection for the selected hard drive.
- 5 Read the warning message. If you wish to continue, click OK.
- 6 In the Set User Password section, enter your new user password. (You may use up to 32 alphanumeric characters, and you may use the same password you are using for the power-on password.)
NOTE: Type carefully because the password does not display as you type it.
- 7 Enter the user password again to verify it.
- 8 Click OK.
- 9 In the Set Master Password section, enter your new master password. (You may use up to 32 alphanumeric characters, and you may use the same password you are using for the power-on password.)
NOTE: Type carefully because the password does not display as you type it.
- 10 Enter the master password again to verify it.
- 11 Click OK.
- 12 Read the warning message. If you want to establish DriveLock, type “DriveLock” at the prompt.
- 13 Click OK.

The changes will take place when Computer Setup has been exited normally. You will be prompted to enter your user password the next time you boot your computer using that hard drive.

Changing the User Password

NOTE: If you forget your user password, you can access your removable hard drive with the master password. Make note of the user password. Record the master password and put it in a safe place physically separate from the computer.

Once you create a user password, you can only change the password after the computer has restarted and the protected hard drive has been unlocked.

To change your password, follow these instructions after you have restarted your computer and entered the current user password to unlock the drive:

- 1 Turn on or restart the computer and enter your current user password.
- 2 Run Computer Setup.
- 3 Click the System Features icon → Security Management box → DriveLock tab.
- 4 In the Current Drive section, select either Armada hard drive bay or Armada MultiBay.
- 5 In the User Password section, click on Change.
- 6 Type the old user password.
- 7 Enter your new user password. (You may use up to 32 alphanumeric characters, and you may use the same password you are using for the power-on password.)
NOTE: Type carefully because the password does not display as you type it.
8. Enter the password again to verify it.
- 9 Click OK.

Removing DriveLock Protection



CAUTION: Forgetting or losing both the user and master passwords will render the protected hard drive permanently unusable. Record your master password and keep it in a secure location physically separate from your computer. In the event you lose the user password, the master password can be used to unlock a protected hard drive and reset the user password.

Once you create a user password, you can only delete the passwords after the computer has restarted and the protected hard drive has been unlocked. Removing DriveLock protection deletes both the user password and the master password.

- 1 Turn on or restart the computer and enter your current user password.
- 2 Run Computer Setup.
- 3 Click the System Features icon → Security Management box → DriveLock tab.
- 4 In the Current Drive section, select either Armada hard drive bay or Armada MultiBay.
- 5 In the Drive Protection section, click on Remove.
- 6 Enter the master password.
- 7 Enter the master password again to verify it.
- 8 Click OK → Save and Exit.

The changes will take place when Computer Setup has been exited normally.

Changing the Master Password



CAUTION: Forgetting or losing both the user and master passwords will render the protected hard drive permanently unusable. Record your master password and keep it in a secure location physically separate from your computer. In the event you lose the user password, the master password can be used to unlock a protected hard drive and reset the user password.

Once you create a master password, you can only change the password after the computer has restarted and the protected hard drive has been unlocked.

To change your master password, follow these instructions after you have restarted your computer and entered the current user password:

- 1 Turn on or restart the computer and enter your current user password.
- 2 Run Computer Setup.
- 3 Click the System Features icon → Security Management box → DriveLock tab.
- 4 In the Current Drive section, select either Armada hard drive bay or Armada MultiBay.
- 5 In the Master Password section, click on Change.
- 6 Type the old master password.
- 7 Enter your new master password. (You may use up to 32 alphanumeric characters, and you may use the same password you are using for the power-on password.)
NOTE: Type carefully because the password does not display as you type it.
- 8 Enter the password again to verify it.
- 9 Click OK.

Disabling and Enabling Devices

Several devices can be disabled to prevent the unauthorized transfer of data using these devices:

- Diskette drive
- Diskette drive boot ability
- Serial port
- Infrared port
- Parallel port
- PC Card slots

To disable or enable a device:

- 1 Run Computer Setup.
- 2 Under the View menu, select either View by Type or View by Connection.
- 3 Click the icon for the device you want to disable.
- 4 Select the tab for the device you want to disable or enable. An **X** indicates that the selected device is disabled.
- 5 Click OK → Exit → Save.

Changes take effect when you restart the computer.

Using the Cable Lock

The security slot accommodates a cable lock so that the computer can be physically secured to a work area.

- 1 Loop the cable around a heavy, fixed object to which you want to secure the computer.
- 2 Insert the cable lock end of the cable through the loop end of the cable.
- 3 Insert the lock into the security slot.



- 4 Lock with the key.

NOTE: The cable lock can be purchased from Kensington Microware Limited or Compaq authorized dealers, resellers, and service providers worldwide. Ask for the Kensington MicroSaver Security System, Model 64068.

chapter 14

INTELLIGENT MANAGEABILITY

Intelligent Manageability Overview

Intelligent Manageability consists of preinstalled software tools for the computer and Compaq servers that assist in tracking, troubleshooting, protecting, and maintaining the computer. It provides the following functions:

- **Asset Management**—provides detailed configuration and diagnostic information.
- **Fault Management**—prevents, predicts, and alerts of impending hardware problems.
- **Security Management**—protects unauthorized access to data and components.
- **Integration Management**—uses industry-standard technologies such as DMI and SNMP to integrate with PC management software providers.
- **Configuration Management**—optimizes the computer by providing the latest drivers, utilities, and software, which are available on CD-ROM and the Compaq web site at www.compaq.com.

NOTE: For further help with Intelligent Manageability, refer to Intelligent Manageability Help. To access Intelligent Manageability Help, click Start → Compaq Information Center → double-click Intelligent Manageability.

Asset Management Overview

AssetControl enables the user to retrieve component information when on the road or connected to the network.

AssetControl also enables the network administrator to remotely retrieve information from any Compaq computer connected to the network. The information can be used to assist in tracking and maintaining the computer and its components. It provides the following information:

- **Inventory information**—The network administrator can retrieve information about the computer over the network by using Compaq Insight Manager or any PC management tool provided by Compaq Solution Partners. AssetControl information retrieved from the computer includes
 - Manufacturer, model, and serial number of Compaq computers, monitors, hard drives, battery packs, memory boards, processor speeds, and operating systems.
 - Asset tag
 - System board and ROM revision levels
 - BIOS settings
- **Diagnostic information**—Diagnostics for Windows includes the information on hard drives, ports, and video, sound, and other components. Compaq Diagnostics for Windows can be accessed by clicking Start → Programs → Compaq Utilities → Compaq Diagnostics.

All of the above information can be viewed, printed, or saved.

Changing the Asset Tag Number

- 1 Turn on or restart the computer.
- 2 Press **F10** when the cursor appears in the upper right corner of the screen.
- 3 Select Computer Setup → Intelligent Manageability.
- 4 Follow the instructions on the screen.

Fault Management Overview

The Fault Management features minimize downtime and data loss by monitoring system performance and generating the following alerts:

- **Hard drive alert**—warns you up to 72 hours in advance of impending hard drive problems and can automatically start optional backup software.
- **System temperature alert**—reports overheating. As the system temperature rises, this feature first adjusts fan speed and other cooling components, then displays an alert, then shuts down the system.
- **Battery pack alert**—reports charging problems and battery pack failure.
- **Monitor alert**—diagnoses and displays external monitor operational problems.
- **Memory alert**—reports memory board configuration changes when a memory board is removed, added, or reconfigured. It also provides the previous and current configurations for comparison.

The alerts work with or without network connection. Of course, if your computer is not connected to the network, your network administrator cannot receive alerts from your computer.

Fault Management Alerts Overview

Alerts can be enabled, disabled, and tested, and software can be set to back up information whenever a hard drive alert occurs.

- While the computer is connected to a network, alerts pop up on the computer display and are simultaneously reported to the network console.
NOTE: A battery charging problem alert is reported only on the computer display.
- When the computer is not connected to a network, the user will receive a local alert.

To set alerts, double-click the Intelligent Manageability icon in the system tray.

Security Management Overview

Security Management features customize system security.

- **Power-On and Setup Passwords**—prevent unauthorized access to your information and computer configuration.
- **DriveLock**—denies access to hard drives.
- **Device Disabling**—prevents unauthorized data transfer through modems, serial ports, parallel ports, and infrared ports on the computer and an optional docking station.
- **QuickLock/QuickBlank**—locks the keyboard and clears the screen.
- **Ownership Tag**—displays ownership information during system restart.

Configuration Management Overview

Configuration Management optimizes software upgrade and customer support procedures. Compaq provides you with support software to optimize the performance of your computer. This support software is accessible through a monthly CD-ROM which can be ordered. Support software can also be downloaded from the Compaq web site at www.compaq.com. Support software includes:

- **Locator Browser**—searches for the latest device drivers, utilities, ROM images, and other support software on a CD-ROM and at the Compaq web site at www.compaq.com.
- **Decision Support**—provides detailed information about drivers, utilities, and software available on the computer. The information includes descriptions, features, enhancements, dependencies, and necessary upgrades.
- **InfoMessenger**—provides notifications by email when support software for your computer becomes available.

chapter 15

COMPUTER SETUP AND DIAGNOSTICS UTILITIES

Computer Setup Overview

Computer Setup contains utilities that give you an overall picture of the computer hardware configuration and aid in troubleshooting. These utilities also allow you to set custom features, such as security options, power conservation levels, and startup preferences.

If you are running Windows 95, the computer automatically recognizes and configures the system for new devices. If you have a configuration problem or want to view or reset configuration settings, you can use Computer Setup.

NOTE: If you are running Windows 95, you should use Computer Setup only to adjust system features such as the power-on password or battery conservation level. Windows 95 may override other configuration changes.

If you are running Windows NT, the computer does not automatically recognize new devices added to the system. All devices ordered with your system have been configured for you. Use Computer Setup to view settings for a new device you have added or to reset configuration settings for preinstalled devices.

Computer Setup provides two methods of viewing the computer configuration—by type (factory setting) or connection.

Categories by type:

- System Features—security, power, boot management
- Communication—port, modem, and other communication devices
- Storage—storage-related devices such as hard drive, CD-ROM drive, diskette drive
- Input Devices—keyboard, mouse, and other input devices
- Network—network adapter or other network-related devices
- Audio—sound properties and audio device settings
- Video—monitor timeouts and video device resources
- Other—miscellaneous devices

Categories by connection:

- System Features—security, power, boot management
- System Devices—keyboard, mouse, parallel and serial ports
- ISA—ISA bus and related devices
- PCI—PCI bus and connected devices
- PC Card—PC Card devices

Running Computer Setup

- 1 Turn on or restart the computer by clicking Start → Shut Down → Restart the computer.
- 2 Press **F10** when the blinking cursor appears in the upper-right corner of the screen.
NOTE: If you enabled a setup password, it must be used to access Computer Setup.
- 3 Click a language and press **Enter**.
- 4 Click Computer Setup and press **Enter**.
- 5 When you are finished, click Exit. A series of Exit options appear.

Exiting Computer Setup

- 1 Click Exit.
- 2 Select one of the following Exit options:
 - Save
Saves the new settings and exits Computer Setup.
NOTE: Some settings may not take effect until the computer is restarted.
 - Ignore
Exits Computer Setup and restores previous settings.
 - Cancel
Returns to Computer Setup.

Using Compaq Utilities

Compaq Utilities contain several functions that

- Determine if various computer devices are recognized by the system and are operating properly.
- Provide information about the system once it is configured.

Compaq Utilities include the following programs:

- Computer Setup
- Computer Checkup (TEST)
- View System Information (INSPECT)

To access Compaq Utilities

- 1 Turn on or restart the computer by clicking Start → Shut Down → Restart the computer.
- 2 Press **F10** when the blinking cursor appears in the upper-right corner of the display.
- 3 Select a menu option.

Running Computer Checkup (TEST)

Computer Checkup (TEST) determines whether the various computer components and devices are recognized by the computer and are functioning properly. You can display, print, or save the information generated by Computer Checkup.

To run Computer Checkup

- 1 Plug the computer into an external power source.
(A low battery condition could interrupt the program.)
- 2 Connect a printer if you want to print a log of error messages.
- 3 Turn on the external devices that you want to test.
- 4 Turn on or restart the computer.
- 5 Access Compaq Utilities by pressing **F10** when the blinking cursor appears in the upper-right corner of the display.
- 6 Click Computer Checkup → View the Device List.
 - If the list of installed devices is correct, click OK.
 - If the list is incorrect, ensure that any new devices are installed properly.

NOTE: Compaq Utilities are intended for testing only Compaq-supplied components. Testing of non-Compaq components may be inconclusive. If there is a problem with a non-Compaq component, contact your Compaq authorized dealer, reseller, or service provider.

- 7 Select one of the following from the Test Option menu:
 - Quick Check Diagnostics
 - Automatic Diagnostics
 - Prompted Diagnostics
- 8 Follow the instructions on the screen as the devices are tested.
- 9 Click Exit Diagnostics → Exit from this utility.

Running View System Information (INSPECT)

The View System Information (INSPECT) utility provides information about the computer and installed or connected devices. You can display, print, or save the information.

To run INSPECT

- 1 Connect a printer if you want to print the INSPECT information.
- 2 Turn on or restart the computer.
- 3 Access Compaq Utilities by pressing **F10** when the blinking cursor appears in the upper-right corner of the display.
- 4 If prompted, select a language.
- 5 Click View System Information (INSPECT).
- 6 Click the item you want to view from the following list:
 - System
 - ROM
 - Keyboard
 - System ports
 - System storage
 - Graphics
 - Memory
 - Audio
 - Operating system
 - System files
 - Windows files
- 7 Follow the instructions on the screen to cycle through the screens, to return to the list and choose another item, or to print the information.

Running Compaq Diagnostics

Compaq Diagnostics provides computer component information when the operating system is working.

If you are running Windows 95, access Compaq Diagnostics for Windows by double-clicking My Computer → Control Panel → Compaq Diagnostics.

If you are running Windows NT, access Windows NT Diagnostics by clicking Start → Programs → Administrative Tools → Windows NT Diagnostics.

Boot Sequencing

- 1 Run Computer Setup.
- 2 Click the System Features icon → Boot Management box → MultiBoot tab.
- 3 Designate the hard drive boot (startup) sequence you want.
- 4 Click OK to accept the changes.

Factory Default Settings

Initialization

Enable POST Memory Test	Checked (enabled)
Keyboard Num Lock	Unchecked (Off)
Hard Drive Boot Sequence	
1	Hard drive in the computer hard drive bay
2	Hard drive in the computer MultiBay
3	Hard drive in the desktop expansion base or convenience base MultiBay
4	Hard drive in the desktop expansion base half-height bay (if converted to a MultiBay)
Boot Display	Auto
Language	Language of country

Ports

Serial/Infrared Ports	
Serial Port	3F8, IRQ4
Infrared Port	3F8, IRQ4
Parallel Port	3F8, IRQ7
Ethernet Port	300, IRQ9

Power

Low Battery Warning Beep	Checked (enabled)
External Energy Saving Monitor Connected	Unchecked (not connected)
Power Management	
Enabled	While operating power on battery
Conservation Level	Medium
Level Definition	
High	Suspend Time: 5 minutes
	Hibernation Timeout: Immediate
	Drive Timeout: 2 minutes
	Screen Timeout: 2 minutes
Medium	Suspend Time: 10 minutes
	Hibernation Timeout: 1 hour
	Drive Timeout: 6 minutes
	Screen Timeout: 4 minutes
Custom	Suspend Time: disabled
	Hibernation Timeout: low battery
	Drive Timeout: always on
	Screen Timeout: always on

Security

Enable QuickLock/QuickBlank	Unchecked (Disabled)
Enable Power-On Password	Unchecked (Disabled)
Disable Serial/Infrared Ports	Unchecked (Enabled)
Disable Parallel Port	Unchecked (Enabled)
Disable PC Card Slots	Unchecked (Enabled)
Setup Password	Password blank
Power-On Password	Password blank
Diskette Drives	
Disable Diskette Drives	Unchecked (Enabled)
Disable Diskette Boot	Unchecked (Enabled)

chapter 16

TROUBLESHOOTING

Checklist for Solving Problems

If you encounter a minor problem with the computer or software applications, go through the following checklist for possible solutions:

- Is the computer connected to an external power source or does it have a fully charged battery pack installed?
- Are all cables connected properly and securely?
- Did the diskette drive contain a nonbootable diskette when you turned on the computer?
- Have you installed all the needed device drivers? For example, if you are using a mouse, you may need to install a mouse device driver.
- Are printer drivers installed for each application?

While the computer is configured just for you, problems you encounter while working may not be unique. Eliminating the typical problems described in this Troubleshooting section may save you time and money. If the problem appears related to a software application, also check the documentation provided with the software. You may discover something you can resolve easily by yourself.

If the condition persists, contact your Compaq authorized dealer or service provider.

Solving Audio Problems

Computer does not beep after the Power-On Self-Test (POST)

Possible Cause

Speaker volume has been turned down.

Solution

Adjust the volume with the volume control buttons located at the top right corner of the computer.

Internal speaker does not produce sound when an external audio source is connected to the stereo line-in jack

Possible Cause

Volume may be turned off or set too low.

Solutions

- Adjust the volume control located at the top right corner of the computer.
- Use the volume control and mixing features available in Control Panel → Multimedia.
- Adjust the volume using the speaker icon on the taskbar.

Possible Cause

Line input may not be connected properly.

Solution

Check line input connection.

Possible Cause

Headphones or speakers are connected to the stereo speaker/headphone jack, which disables the internal speakers.

Solution

Disconnect the headphones or speakers to enable the internal speakers.

External microphone does not work

Possible Cause

You are using the wrong type of microphone or microphone plug for the computer.

Solution

Check to see if you are using a monophonic electret condenser microphone with a 3.5-mm plug.

Possible Cause

The microphone may not be connected properly.

Solution

Ensure that the microphone plug is properly connected to the mono microphone jack.

Possible Cause

Sound source is not selected.

Solution

Ensure that microphone is selected as the recording source in Control Panel → Multimedia and that the recording level is adjusted.

No sound from game program

Possible Cause

Audio settings are not set correctly.

Solution

Check the game program's audio settings.

Possible Cause

Computer volume control is turned down.

Solution

Adjust the volume with the volume control buttons located at the top right corner of the computer.

Possible Cause

Headphones are connected.

Solution

Use or disconnect the headphones.

No sound from headphones

Possible Cause

Volume or mixing controls set incorrectly.

Solutions

- Adjust the volume with the volume control buttons located at the top right corner of the computer.
- Use the volume control and mixing features available in Control Panel → Multimedia.

Possible Cause

Sound source not selected.

Solution

Verify that the sound source is selected in Control Panel → Multimedia.

Possible Cause

The headphones are connected to the wrong jack.

Solution

Check the connection.

Volume too low or too loud

Possible Cause

Volume or mixing controls set incorrectly.

Solutions

- Adjust the volume with the volume control buttons located at the top right corner of the computer.
- Check the volume and mixer controls in Control Panel → Multimedia.

Solving Battery Pack/Battery Gauge Problems

Computer is beeping and battery power light is blinking

Possible Cause

Battery pack charge is low.

Solutions

- Charge the battery pack.
- Replace the battery pack.
- Connect the computer to an external power source.
- Initiate Hibernation.

Computer battery power light blinks to indicate low battery condition, but computer does not beep

Possible Cause

Volume is turned down too low.

Solution

Turn up the volume using the volume control buttons located at the top right corner of the computer.

Battery pack will not charge

Possible Cause

If this is the computer's first use, battery pack is still in ship mode.

Solution

Take the battery pack out of the battery bay and reinsert it to take it out of ship mode.

Possible Cause

Battery pack was exposed to temperature extremes.

Solution

Allow time for the battery pack to return to room temperature.

Possible Cause

Battery pack is already charged.

Solution

No action required.

Possible Cause

Battery pack has exceeded its useful life cycle.

Solution

Use a different battery pack.

Computer shut down and memory was lost when replacing the battery pack

Possible Cause

When the computer is in Suspend, the battery pack must be replaced within 10 minutes to prevent loss of information.

Solution

Wait a few seconds until the computer initiates Suspend before removing the battery pack. Insert the battery pack within 10 minutes.

Every time computer is turned on, date and time must be set

Possible Cause

The auxiliary battery is not fully charged because the computer has not been used for a while.

Solutions

- Fully charge the battery pack. This also charges the auxiliary battery.

NOTE: The auxiliary battery may take up to 24 hours to fully charge if it is completely discharged.

- Have a Compaq authorized dealer, reseller, or service provider replace the auxiliary battery.

Battery charge does not last very long

Possible Cause

Battery pack is exposed to higher temperatures.

Solution

Put the computer in a cooler place and recharge the battery pack.

NOTE: The recommended operating temperature range for the battery pack is from 10°C to 40° C (50°F to 104°F). The recommended storage temperature range for the battery pack is from -20°C to 30°C (-4°F to 86°F).

Possible Cause

Battery pack is exposed to extremely cold temperatures.

Solution

Put the computer in a warmer place and recharge the battery pack.

NOTE: The recommended operating temperature range for the battery pack is from 10°C to 40°C (50°F to 104°F). The recommended storage temperature range for the battery pack is from -20°C to 30°C (-4°F to 86°F).

Possible Cause

Battery pack has partially self-discharged.

Solution

Recharge the battery.

Possible Cause

Battery conservation is disabled or set to drain.

Solution

Reset the battery conservation level.

Possible Cause

An external device is draining the battery pack.

Solution

Turn off or remove any external device when not using it.

Solving Compact Disc/CD-ROM Drive Problems

CD-ROM drive cannot read a compact disc

Possible Cause

Compact disc is not properly seated in the CD-ROM drive.

Solution

Open the CD loading tray, lay the compact disc on it, then close the tray.

Possible Cause

Compact disc is loaded in the CD loading tray upside down.

Solution

Open the CD loading tray, turn over the compact disc (label facing up), then close the tray.

Possible Cause

Compact disc has a scratch on its surface.

Solution

Insert a different compact disc.

CD-ROM drive is not recognized by the computer

Possible Cause

CD-ROM drive is not connected properly.

Solution

If you are running Windows 95, turn off the computer. Remove the CD-ROM drive from the MultiBay, then reinsert it.

If you are running Windows NT, turn off the computer or initiate Suspend. Remove the CD-ROM drive from the MultiBay, then reinsert it.

Solving Diskette/Diskette Drive Problems

Diskette drive cannot read a diskette

Possible Cause

Diskette media has a bad sector.

Solution

Copy remaining files to the hard drive or another formatted diskette. Reformat the diskette.

Possible Cause

Using the wrong diskette type for the diskette drive type.

Solution

Use the required diskette type.

Possible Cause

Diskette is not formatted.

Solution

Format the diskette.

If you are using Windows 95:

- 1 From the Windows 95 desktop, double-click My Computer.
- 2 Click 3 ½ Floppy (A) → File → Format.
- 3 Fill in the appropriate information, then click Start.

If you are using Windows NT, format the diskette by entering **format a:** at the system prompt.

Diskette drive cannot write to a diskette

Possible Cause

Diskette is not formatted.

Solution

Format the diskette.

If you are using Windows 95:

- 1 From the Windows 95 desktop, double-click My Computer.
- 2 Click 3 ½ Floppy (A) → File → Format.
- 3 Fill in the appropriate information, then click Start.

If you are using Windows NT, format the diskette by entering **format a:** at the system prompt.

Possible Cause

Diskette is write-protected.

Solution

Use another diskette that is not write-protected or disable the write-protect feature.

Possible Cause

Writing to the wrong drive.

Solution

Check the drive letter in your path statement.

Possible Cause

Not enough space is left on the diskette.

Solution

Save the information to another diskette.

Possible Cause

Diskette drive is disabled.

Solution

Enable the diskette drive through Device Manager.

Possible Cause

Disable diskette write ability is turned on.

Solution

Run Computer Setup. Click on the Storage icon. Make sure Disable diskette write ability is not checked.

Solving Hard Drive Problems

Accessing information on the hard drive is much slower than usual

Possible Cause

System entered Hibernation due to low-battery condition and is now exiting from it.

Solution

Wait for the system to restore the previously saved data to its state prior to initiating Hibernation.

Hard drive error occurs

Possible Cause

Hard drive has bad sectors or has failed.

Solutions

- If you are running Windows 95, access ScanDisk by clicking Start → Programs → Accessories → System Tools → ScanDisk, then check the Automatically fix errors box. Click Start to begin scanning.

If you are running Windows NT, go to the system prompt and type **chkdsk**. The computer will automatically scan for errors.



CAUTION: Reformatting the hard drive erases all of your files permanently; be sure to make backup diskettes of your information before reformatting the drive. Compaq also recommends that you order a backup of the preinstalled software before reformatting your hard drive.

- Reformat the hard drive.
 - Contact your Compaq authorized dealer, reseller, or service provider or Compaq customer support for assistance.
-

Hard drive does not work

Possible Cause

Hard drive is not seated properly.

Solution

Turn off and unplug the computer, remove the hard drive, and reinsert the hard drive.

Errors occur after starting from an additional hard drive

Possible Cause

Additional hard drive has not been prepared with required software.

Solution

Boot from the original hard drive or another hard drive that has been prepared with required software.

Solving Infrared Problems

Cannot communicate with another computer

Possible Cause

The required software is not running on both computers.

Solution

Install the required software on the second computer, start the second device and start the program on both computers.

Possible Cause

One computer does not have an IrDA-compliant infrared port.

Solution

Communication between infrared devices must use the same protocol.

Possible Cause

The pathway between the infrared ports is obstructed, one port is more than 30 degrees (plus or minus 15 degrees off the center line) from the other, or the ports are more than 1.5 feet (about 0.5 meter) apart.

Solution

Remove the obstruction, align the infrared ports to within 30 , and position computers within 1.5 feet (about 0.5 meter) of each other.

Possible Cause

There is an interrupt request (IRQ) conflict.

Solution

Check for IRQ conflicts in the Device Manager on or both computers. If Device Manager indicates an IRQ conflict, reassign the IRQ number for one of the conflicting devices

Possible Cause

There is a baud rate conflict.

Solution

Select the same baud rate for both computers.

Possible Cause

There is a conflict with the # bits.

Solution

Select the same “# bits” setting for both computers.

Possible Cause

There is a stop bit conflict.

Solution

Select the same stop bit for both computers.

Possible Cause

There is a parity conflict.

Solution

Select the same parity setting for both computers.

Cannot transmit data

Possible Cause

Direct sunlight, fluorescent light, or flashing incandescent light is close to the infrared connections.

Solution

Remove the interfering light source(s).

Possible Cause

There is interference from other wireless devices.

Solution

Keep remote control devices such as wireless headphones and other audio devices away from the infrared connections.

Possible Cause

A physical obstruction is in the way.

Solution

Do not place objects that will interfere with a line-of-sight data transmission between the two devices.

Possible Cause

One of the devices was moved during data transmission.

Solution

Do not move either device during data transmission.

Possible Cause

The orientation of the units is incorrect.

Solution

Adjust the devices so that they point directly at each other.

Possible Cause

The distance between the devices is too great.

Solution

Verify that devices are not more than 1.5 feet (0.5 meter) apart.

Infrared port does not work

Possible Cause

Direct sunlight, fluorescent light, or flashing incandescent light is close to the infrared connection.

Solution

Remove the interfering light source(s).

Possible Cause

There is interference from other wireless devices.

Solution

Keep remote control devices such as wireless headphones and other audio devices away from the infrared connections.

Solving Keyboard/Numeric Keypad Problems

Screen is blank and keyboard is working

Possible Cause

A screen timeout has been initiated.

Solution

Press any key to return information to the screen.

Possible Cause

QuickLock/QuickBlank has been initiated.

Solution

To reenable the keyboard and return your information to the screen, enter your power-on password.

Embedded numeric keypad on computer keyboard is disabled

Possible Cause

Num Lock function is not turned on.

Solution

Press **Fn+Num Lk** to enable the Num Lock function and embedded numeric keypad.

Possible Cause

There is an external keyboard attached to the computer through either the external keyboard connector or the USB connector.

Solution

Disconnect the external keyboard from the rear of the computer.

Solving PC Card Problems

Computer does not beep when a PC Card is inserted

Possible Cause

PC Card is not inserted properly.

Solution

Try reinserting the card. Ensure that the PC Card is inserted in the correct orientation. Insert the card gently to prevent damage to the pins.

Possible Cause

Speakers are turned off or volume is turned down.

Solution

Adjust the computer volume with the volume control buttons on the computer.

Possible Cause

PC Card slots are disabled.

Solution

- 1 Run Computer Setup.
 - 2 Click the System Features icon → Power Management box.
 - 3 Click the option to enable PC Card slots.
-

Possible Cause

PC Card or card driver is not PCMCIA compliant.

Solution

Contact your Compaq authorized dealer, reseller, or service provider for a list of PC Cards tested successfully with Compaq computers.

Computer beeps only once when a PC Card is inserted

Possible Cause

The computer beeps once to indicate that a PC Card is recognized but not properly configured.

Solution

Before a new PC Card can be used, it may be necessary to perform an initial setup procedure. Follow the PC Card manufacturer's instructions for formatting a hard drive card or installing PC Card-specific drivers for a network card.



CAUTION: Compaq has tested the PC Card software preinstalled on the computer. If you install card and socket services or enablers provided by other manufacturers over software preinstalled on the computer, your computer may no longer work properly with all of your PC Cards.

PC Card drivers fail with error messages during system restart

Possible Cause

PC Card slots are disabled.

Solution

Before a new PC Card can be used, it may be necessary to perform an initial setup procedure. Follow the PC Card manufacturer's instructions for formatting a hard drive card or installing PC Card-specific drivers for a network card. To enable the PC Card slots:

- 1 Run Computer Setup.
- 2 Click the System Features icon → Power Management box.
- 3 Click the option to enable PC Card slots.



CAUTION: Compaq has tested the PC Card software preinstalled on the computer. If you install card and socket services or enablers provided by other manufacturers over software preinstalled on the computer, your computer may no longer work properly with all of your PC Cards.

Network PC Card does not work

Possible Cause

Required drivers are not installed (turned on).

Solution

Refer to the instructions that came with the PC Card or contact the manufacturer for information on installing the correct drivers.



CAUTION: Compaq has tested the PC Card software preinstalled on the computer. If you install card and socket services or enablers provided by other manufacturers over software preinstalled on the computer, your computer may no longer work properly with all of your PC Cards.

Possible Cause

PC Card is not fully inserted or is upside down.

Solution

Ensure the PC Card is inserted correctly.

Possible Cause

Network PC Card or driver is not PCMCIA compliant.

Solution

Contact your Compaq authorized dealer, reseller, or service provider for a list of PC Cards tested successfully with Compaq computers.

Storage PC Card does not work

Possible Cause

SRAM and flash memory PC Cards require the memory card driver to be loaded.

Solution

Memory cards can only be accessed using DOS real mode drivers.

Possible Cause

You are trying to access the storage PC Card using the wrong drive letter.

Solution

If you are using Windows 95, change the drive letter assignment in Device Manager.

If you are using Windows NT, change the drive letter assignment through the Control Panel.

Possible Cause

The PC Card is not formatted.

Solution

For memory cards, run MCFORMAT in MS-DOS Mode to format the PC Card. For ATA cards, run ATAINIT, then run MCFORMAT in MS-DOS Mode to format the PC Card.

Possible Cause

The card is not supported.

Solution

Contact your Compaq authorized dealer, reseller, or service provider for a list of PC Cards tested successfully with Compaq computers.

Solving Power Problems

Computer will not turn on

Possible Cause

Battery pack is discharged and the computer is not connected to a power source.

Solutions

- Charge the battery pack.
- Replace the battery pack.
- Connect the computer to an external power source.

Possible Cause

Battery is discharged and cables to the external power source are unplugged.

Solution

Ensure that cables connecting the computer and the external power source are plugged in properly.

Computer turned off while it was left unattended

Possible Cause

The system initiated Hibernation because of a critical low battery condition.

Solutions

- Charge the battery pack.
- Replace the battery pack.
- Connect the computer to an external power source.

Possible Cause

The system initiated Hibernation after a user-defined timeout expired.

Solution

Turn on the computer.

Solving Screen Problems

Characters on computer display are dim

Possible Cause

Computer is in direct light.

Solution

Move the computer or adjust the screen.

Possible Cause

The brightness control is not set properly.

Solution

Adjust the brightness.

Screen is blank

Possible Cause

A screen saver or screen blanking utility may be installed.

Solution

Press any key to return information to the screen.

Possible Cause

The brightness control is not set properly.

Solution

Adjust the brightness control.

Possible Cause

Screen timeout was initiated.

Solution

Press any key to light the screen.

Possible Cause

System initiated Suspend after a user-defined timeout expired.

Solution

Press the suspend button to exit Suspend.

Possible Cause

Computer initiated a low battery Suspend or Hibernation.

Solutions

- Replace the battery pack and exit Suspend or Hibernation.
 - Connect the computer to an external power source and exit Suspend or Hibernation.
-

Possible Cause

Power Management, which controls Suspend and Hibernation, is disabled and the battery pack has discharged.

Solutions

- Replace the battery pack and turn on the computer.
 - Connect the computer to an external power source and turn on the computer.
-

Computer screen is blank and external monitor displays information

Possible Cause

Display was switched to the external monitor.

Solution

Press **Fn+F4** to display information on the computer screen; press **Fn+F4** again to display information simultaneously on both screens.

Possible Cause

Display switch is stuck.

Solution

Tap the switch.

Solving USB Problems

External device connected to a USB connector does not work

Possible Cause

The operating system limits external devices connected by USB to two tiers which can include no more than two hubs on the first tier and no more than one keyboard and one pointing device on the first or second tier.

Solution

Reduce the number of connected external USB devices to no more than two hubs on the first tier, and no more than one keyboard and one pointing device on the first or second tier.

External device connected to USB connector does not work during startup (before Windows 95 loads)

Possible Cause

During startup, only two tiers are supported by the USB connector. These tiers can include no more than two hubs on the first tier and no more than one keyboard and one pointing device on the first or second tier.

Solutions

- Use the external device only after Windows 95 has loaded.
- Reduce the number of connected external USB devices to no more than two hubs on the first tier, and no more than one keyboard and one pointing device on the first or second tier.

External devices in lower tiers do not work

Possible Cause

An unpowered hub is connected to another unpowered hub.

Solutions

- Use only powered hubs.
 - Make sure that all unpowered hubs are immediately preceded by powered hubs in the USB chain.
-

Solving Modem Problems

Modem loses connection

Possible Cause

The telephone cable connection between the telephone wall jack and the modem is loose.

Solution

Check to make sure the telephone cable is properly connected.

Possible Cause

Call Waiting has not been disabled.

Solution

Disable Call Waiting.

1. Click Start → Control Panel → double-click Modems.
 2. From the General tab of the Modems Properties page, click Dialing Properties.
 3. From the My Locations tab of the Dialing Properties page, check the box labeled **This location has call waiting**.
 4. Select *70, 70#, or 1170 from the drop-down list to disable call waiting for your dialing area.
-

Characters are garbled/transfer rates are slow

Possible Cause

There is noise in the telephone line.

Solutions

- Check your telephone and modem cable connections. If they are loose, they can cause noise on the line.
 - Check with your local telephone company for a phone line filter.
-

Phone line noise causes a disconnection

Possible Cause

Hang-Up Delay S Register (S10) set too low.

Solution

Change S10 default to 150.

- 1 Click Start → Programs → Accessories → HyperTerminal
- 2 Go to Command Mode.
- 3 Type **ATS10=150** and press **Enter**.

This command causes the modem to take longer to disconnect even if there is noise on the line.

No dial tone

Possible Cause

Phone service is not connected to the telephone wall jack.

Solution

Verify service from the local phone company:

- 1 Unplug the telephone cable from the telephone wall jack.
- 2 Connect a telephone to the jack, pick up the handset, and listen for a dial tone. If there is a dial tone, reconnect the modem to the telephone wall jack with the telephone cable and make sure all connections are secure.
- 3 If there is still no dial tone, contact your local phone company or building manager.

Possible Cause

The modem is plugged into a digital PBX line rather than an analog line.

Solution

Plug the modem into an analog line. If you are in an office, the analog line is often the one connected to a fax machine or modem. To get an analog line in a hotel, request a room with a “data” line.

Possible Cause

The modem is not responding to commands from the computer keyboard.

Solution

Verify the modem and computer are connected:

- 1 Click Start → Programs → Accessories → HyperTerminal
- 2 Go to Terminal Mode.
- 3 Type **AT** and press the **Enter** key.

If the modem displays OK, the modem and computer are working together. If the modem displays ERROR, or does not respond, restart the computer and repeat step 1.

- 1 Type **ATDT** and listen for a dial tone.
- 2 Type **ATH0** to hang up.

Cellular connection doesn't work (United States only)

Possible Cause

Environmental factors are interfering with the cellular connection.

Solution

Refer to How the Environment Affects Cellular Performance for more information.

Ten digit dialing does not work correctly under Windows 95

Possible Cause

Ten digit dialing doesn't work correctly under Windows 95, making it difficult to dial numbers in a different area code that are not long distance calls.

Solution

Since Windows 95 does not limit the number of digits you can enter in the Phone Number field, set the Area Code field to match your local area code. Then type the 10-digit telephone number in the Phone Number field.

Modem cable disables/interferes with other telephony devices (Germany, Austria, and Switzerland only)

Possible Cause

The modem cable does not provide the additional 4-wire connection required in Germany, Austria, and Switzerland to form the serial pass-through necessary so that other devices can work on the same phone line.

Solution

To use another telephony device on the same line in these countries, unplug the modem cable from the wall jack first.

Modem does not dial correctly under Windows 95 (Switzerland and Germany only)

Possible Cause

The “Wait for dial tone before dialing” check box is checked. This causes Windows 95 to issue an ATDT; command. A typical dial string would look like this:

ATDT;

ATDTnnn-nnnn

In Germany and Switzerland, the ‘;’ dial modifier is not permitted to be used in this fashion by regulatory agencies since ATDT; takes the modem off-hook without dialing. Therefore, the modem returns an error message when attempting to dial. The error message reads:

“The computer is not receiving a response from the modem. Check that the modem is plugged in, and if necessary, turn the modem off, and then turn it back on.”

Solution

- 1 Click Start → Settings → Control Panel.
- 2 Double-click the Modems icon.
- 3 Click the Properties button.
- 4 Select the Connection tab.
- 5 Click the “Wait for dial tone before dialing” check box to clear it.
- 6 Click OK → Close.

Modem does not identify modem cable correctly

Possible Cause

The internal modem identifies a non-U.S. modem cable as a U.S. model if the cable is defective, from an unsupported country, or if the path to the cable is defective (for example, the expansion base I/O board is defective).

Solution

- 1 Verify that the cable is for a supported country. Supported cables will have one of the following country abbreviations on the back of the connector: AUS, AUT, BEL, CHE, DEN, DEU, FIN, FRA, GBR, JAP, NLD, NOR, NZL, SWE, or USA.
 - 2 Verify that the cable is fully seated into the 25-pin connector on the right side of the computer.
 - 3 If the problem occurs while the computer is docked in an expansion base or convenience base, undock the computer and plug the cable into the computer to find out whether the problem is with the cable or the expansion base or convenience base.
 - 4 If the modem is still incorrectly identifying the cable, the cable may be defective and should be replaced.
-

appendix A

COMPAQ CUSTOMER SUPPORT

Preparing for a Technical Support Call

If you cannot solve a problem using the troubleshooting tips in Chapter 16 and the online Troubleshooting help, you may need to call technical support. To receive the fastest possible solution when you call, follow the instructions in Chapter 15 to run the Compaq diagnostics utilities and have the following available when you call:

- The computer
- Serial number on the bottom of the computer
- Purchase date on invoice
- Conditions under which the problem occurred
- Error messages that occurred
- Hardware configuration
- Type of printer connected
- Hardware and software you are using
- Product identification number (PIN), which you entered when you set up the computer. (Click Start → Settings → Control Panel → System → General tab. Your PIN number is below your name.)
- Printed error message log from Computer Checkup (TEST), or a list of the devices and error messages received
- Configuration settings in View System Information (INSPECT), including contents of the system files

NOTE: If you take your computer to a Compaq authorized reseller, dealer, or service provider for service, remember to provide the power-on and setup passwords, if they are set.

Worldwide Telephone Numbers

Locate your geographical area in the following table and use one of the telephone numbers for Compaq assistance.

General Information Numbers—Product information, technical assistance, and the location of your nearest Compaq authorized dealer, reseller, or service provider.

Technical Support Numbers—Hardware technical support in analyzing system configuration and diagnostic problems or troubleshooting.

Customer Support Numbers—Information on service and support programs including warranty, product catalogs, and white papers.

PaqFax Numbers—Automatic facsimile response system for technical and product-specific information that is transmitted to any fax machine. PaqFax is available 24 hours a day.

NOTE: Telephone numbers are subject to change without notice.

*Indicates toll-free domestic numbers.

Worldwide Telephone Numbers		
Location	Country Code	Telephone Number
Argentina		
General Information	+54	-1-796-1616
Technical Support	+54	-1-796-1717
Australia		
General Information		61-2-9911-1999
Technical Support		61-2-9911-1955
PaqFax		61-2-9911-1982
Austria		
General Information*		0222/8 78-16-16
Technical Support*		0222/8 78-16-16
Order Software Backup	+31	-55-38-43-39

Continued

Worldwide Telephone Numbers *Continued*

Location	Country Code	Telephone Number
Belgium / Luxembourg		
Compaq Care Center	Bel Lux	0903-99036 (45 BFr/min.) 089/89.232
General Fax	+32	(0)2/725 22 13
Infoline (resellers, brochures)	+32	(0)2/716 96 96
QuickLine (BBS)	+32	(0)2/716 95 92
Order Software Backup	+32	(0)2/716 96 78
Order Software Backup by Fax	+32	(0)2/716 96 79
Brazil		
General Information	+55	-11-246-7866
Canada		
General Information		1-905-707-1715
Technical Support*		1-800-OKCOMPAQ (1-800-652-6672)
Customer Support*		1-800-263-5868
Order Software Backup*		1-800-952-7689
Battery Pack Recycling*		1-800-263-5868
Caribbean		
General Information		1-281-514-4220
Technical Support		1-281-518-2200
Chile		
General Information	+56	-2-274-1911
Technical Support	+56	-2-274-3007
China		
General Information	+86	-10-6831-3399
Technical Support	+86	-10-6834-6721
Colombia		
General Information	+57	-1-312-0201
Technical Support	+57	-1-345-0266
Czech Republic		
General Information	+420	-2-232-8772
Technical Support	+420	-2-232-8772

Continued

Worldwide Telephone Numbers *Continued*

Location	Country Code	Telephone Number
Denmark		
General Information	+45	-45-90-45-90
Technical Support	+45	-45-90-45-45
Finland		
General Information	+358	-0-615 599
Technical Support*		0203-206 720
QuickLine (BBS)	+358	-0-6155 9870
France		
General Information	+33	-1-41-33-41-33
Technical Support	+33	-1-41-33-44-55
Germany		
		0,48 DM/min.
Hotline		0180/5 21 21 11
Hotline Fax		0180/5 21 21 17
Infoline		0180/3 22 12 21
Infoline Fax		0180/3 22 12 20
QuickLine		0180/5 21 21 18
FaxPaq		0180/5 21 21 19
Order Software Backup*		0130/81 10 81
Hong Kong		
General Information		852-28681382
Technical Support		852-90116633
PaqFax		852-28671648
Hungary		
General Information	+36	-1-457-3600
Technical Support	+36	-1-457-3682
India		
General Information		91-80-559-6023
PaqFax		91-80-559-8989
BBS		91-80-559-8900

Continued

Worldwide Telephone Numbers *Continued*

Location	Country Code	Telephone Number
Israel		
General Information	+972	-3-6363-444
Technical Support	+972	-3-6363-444
PaqFax	+972	-3-6396-601
Italy		
	09:00–18:00 cet	
Information		167-464911
Software Backup		167-859030
Technical Support		02-69633281
	24 Hours	
Fax Support		02-69633282
BBS Service		02-89200222
Japan		
General Information*		0120-101-589
Technical Support*		0120-101-589
Windows 95 Support*		0120-505-589
Order Software Backup *		0120-250-589
FaxStation		81-3-5402-0991
Korea		
Product Information		82-2-523-3575
Customer Support		82-080-902-7777
Malaysia		
General Information		603-717-1188
Technical Support		603-718-1636
Mexico		
General Information	+52	-5-229-7900
Technical Support	+52	-5-229-7910
PaqFax	+52	-5-229-7920

Continued

Worldwide Telephone Numbers *Continued*

Location	Country Code	Telephone Number
Netherlands		
General Information		0182-565805
Customer Support*		06-91681616 (Dfl. 0.75/min)
Fax*		06-8991116 (Dfl. 0.40/min)
QuickLine Bulletin Board		0182-572366
New Zealand		
General Information		64-9-307-3969
Norway		
General Information	+47	-22-07-20-00
Technical Support	+47	-22-07-20-20
Poland		
General Information	+48	-2-630-3535
Technical Support	+48	-2-630-3535
Portugal		
General Information	+351	-1-4128400
Technical Support	+351	-1-4128460
Russia		
General Information	+7	-095-967-1700
Technical Support	+7	-095-967-1700
PaqFax	+7	-095-967-1701
Singapore		
General Information		65-753-6688
Customer Support Center		65-750-3030
PaqFax		65-750-4514
South Africa		
General Information		27-11-728-6999
Technical Support		27-11-728-6999
Spain		
General Information	+34	-902.10.14.14
Technical Support	+34	-1-640-1302

Continued

Worldwide Telephone Numbers *Continued*

Location	Country Code	Telephone Number
Sweden		
General Information	+46	-8-703-5240
Technical Support	+46	-8-703-5240
PaqFax (hämtfax)	+46	-8-703-5225
QuickLine (BBS)	+46	-8-703-5220
Switzerland		
General Information		0844 844 111
Technical Support		01/838 22 22 (German) 01/838 22 23 (French)
QuickLine Bulletin Board		01/838-24 21
Order Software Backup		0800 556 206
Taiwan		
General Information		886-2-7351000
Technical Support		886-2-3761170
BBS		886-2-3761175
Thailand		
General Information		62-2-679-6222
United Arab Emirates (Dubai)		
General Information	+97	14 -818100
United Kingdom		
General Information		0990-134456
FaxPaq		0181-332-3550
QuickLine Bulletin Board		0181-332-9499
United States		
Product Information*		1-800-345-1518
Technical Support*		1-800-OKCOMPAQ (1-800-652-6672)
PaqFax*		1-800-345-1518, Option 1
Download Facility (modem access only)		1-281-518-1418
Order Software Backup*		1-800-952-7689
Battery Pack Recycling*		1-800-524-9859
Venezuela		
General Information	+58	-2-953-6944



appendix **B**

REGULATORY NOTICES

Throughout these regulatory notices, Compaq products are referred to by their regulatory agency series numbers.

Regulatory Agency Series Numbers

Regulatory agencies worldwide use agency series numbers for product identification. Each approved product displays the assigned agency series number. To ensure continued safe and reliable operation, the products listed below should be used only with the Compaq Armada 7800 series of computers.

Product	Agency Series Number
Battery charger	Series 2893
Battery pack	Series 2891
ArmadaStation	Series 2895
Armada MiniStation	Series 2896
Modem (Engines) Cables	Series 575, 576, 577
Auto/Aircraft Adapter	Series 2874

Federal Communications Commission Notice

This equipment has been tested and found to comply with the limits for a Class B digital device, pursuant to Part 15 of the FCC Rules. These limits are designed to provide reasonable protection against harmful interference in a residential installation. This equipment generates, uses, and can radiate radio frequency energy and, if not installed and used in accordance with the instructions, may cause harmful interference to radio communications. However, there is no guarantee that interference will not occur in a particular installation. If this equipment does cause harmful interference to radio or television reception, which can be determined by turning the equipment off and on, the user is encouraged to try to correct the interference by one or more of the following measures:

- Reorient or relocate the receiving antenna.
- Increase the separation between the equipment and receiver.
- Connect the equipment into an outlet on a circuit different from that to which the receiver is connected.
- Consult the dealer or an experienced radio or television technician for help.

Modifications

The FCC requires the user to be notified that any changes or modifications made to this device that are not expressly approved by Compaq Computer Corporation may void the user's authority to operate the equipment.

Cables

Connections to this device must be made with shielded cables with metallic RFI/EMI connector hoods to maintain compliance with FCC Rules and Regulations.

Declaration of Conformity for Products Marked with the FCC Logo (United States only)

This device complies with Part 15 of the FCC Rules. Operation is subject to the following two conditions: (1) this device may not cause harmful interference, and (2) this device must accept any interference received, including interference that may cause undesired operation.

For questions regarding this declaration, write

Compaq Computer Corporation
P. O. Box 692000, Mail Stop 510101
Houston TX 77269-2000
or call 281-514-3333

To identify your product, refer to the part, series, or model number found on the product.

If you have questions about your product that are *not* related to this declaration, please write

Compaq Computer Corporation
P. O. Box 692000, Mail Stop 530113
Houston TX 77269-2000

or call Compaq

Product Information Center	1-800-345-1518
Technical Support	1-800-OKCOMPAQ (1-800-652-6672).

Canadian Notice

This Class B digital apparatus meets all requirements of the Canadian Interference-Causing Equipment Regulations.

Avis Canadien

Cet appareil numérique de la classe B respecte toutes les exigences du Règlement sur le matériel brouilleur du Canada.

European Notice

Products with the CE Marking comply with both the EMC Directive (89/336/EEC) and the Low Voltage Directive (73/23/EEC) issued by the Commission of the European Community.

Compliance with these directives implies conformity to the following European Norms:

- EN55022 (CISPR 22)—Electromagnetic Interference
- EN50082-1 (IEC801-2, IEC801-3, IEC801-4)—Electromagnetic Immunity
- EN60950 (IEC950)—Product Safety

Japanese Notice

この装置は、情報処理装置等電波障害自主規制協議会（VCCI）の基準に基づくクラスB情報技術装置です。この装置は、家庭環境で使用することを目的としていますが、この装置がラジオやテレビジョン受信機に近接して使用されると、受信障害を引き起こすことがあります。

取扱説明書に従って正しい取り扱いをして下さい。

German Ergonomics Notice

The Compaq Armada 7800 series of computers meet the requirements of ZH 1/618 (German Safety Regulations for Display Work Places in the Office Sector) when used in conjunction with docking bases, keyboards, and monitors that bear the “GS” approval mark. The Compaq Armada 7800 series of computers in a stand-alone mode are not intended for continuous use in an office environment.

Airline Travel Notice

Use of electronic equipment aboard commercial aircraft is at the discretion of the airline.

Energy Star Compliance

The Compaq Armada 7800 series of computers are compliant with the U.S. Environmental Protection Agency (EPA) Energy Star Computers Program 2.0. The EPA Energy Star logo does not imply endorsement by the EPA. As an Energy Star Partner, Compaq Computer Corporation has determined the product meets the Energy Star guidelines for energy efficiency.

Battery Notice



WARNING: This computer contains an internal lithium auxiliary battery. There is a risk of explosion and injury if the battery is incorrectly replaced or improperly handled. Do not attempt to recharge, disassemble, immerse in water, or dispose of it in fire. Replacement should be done by a Compaq authorized service provider using the Compaq spare part for this computer.

This computer contains a lithium ion battery pack. There is a risk of fire and chemical burn if the battery pack is handled improperly. Do not disassemble, crush, puncture, short external contacts, dispose in water or fire, or expose it to temperatures higher than 60°C (140°F). Replace only with the Compaq battery pack for this computer.

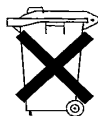

In North America, dispose of nickel metal hydride or lithium ion batteries by taking advantage of the Compaq battery recycling program. You will be provided with a postage-paid battery pack mailer preaddressed to a reclamation facility where the metals are recycled. Call the telephone number listed for your location in Appendix A for more information.

In Europe, do not dispose of batteries with general household waste. Dispose of or recycle them by using the public collection system or returning them to Compaq, your authorized Compaq partners, or their agents.

Power Cords

If you were not provided with a power cord for your computer or for an AC power accessory intended for use with your computer, you should purchase a power cord that is approved for use in your country.

The power cord must be rated for the product and for the voltage and current marked on the product's electrical ratings label. The voltage and current rating of the cord should be greater than the voltage and current rating marked on the product. In addition, the diameter of the wire must be a minimum of 0.75 mm²/18AWG, and the length of the cord must be between 5 feet (1.5 m) and 6½ feet (2 m). If you have questions about the type of power cord to use, contact your Compaq authorized service provider.

A power cord should be routed so that it is not likely to be walked on or pinched by items placed upon it or against it. Particular attention should be paid to the plug, electrical outlet, and the point where the cord exits from the product.

Laser Safety

All Compaq systems equipped with laser products comply with appropriate safety standards, including IEC 825. With specific regard to the laser, the equipment complies with laser product performance standards set by government agencies for Class 1 laser products. It does not emit hazardous light; the beam is totally enclosed during all modes of customer operation and maintenance.

CDRH Regulations

The Center for Devices and Radiological Health (CDRH) of the U.S. Food and Drug Administration implemented regulations for laser products on August 2, 1976. These regulations apply to laser products manufactured from August 1, 1976. Compliance is mandatory for products marketed in the United States.



WARNING: Use of controls or adjustments or performance of procedures other than those specified herein or in the laser product installation guide may result in hazardous radiation exposure.



This system is classified as a Class 1 laser product. This label appears on the laser product.

Laser Information

Laser Type:	Semiconductor GaAlAs
Wave Length:	780 ± 35 nm
Divergence Angle:	$53.5^\circ \pm 1.5^\circ$
Output Power:	Less than 0.2mW or $10,869 \text{ W} \cdot \text{m}^{-2} \cdot \text{sr}^{-1}$
Polarization:	Circular
Numerical Aperture:	0.45 ± 0.04

Only authorized technicians trained by Compaq should attempt to repair this equipment. All troubleshooting and repair procedures are detailed to allow only subassembly/module level repair. Because of the complexity of the individual boards and sub-assemblies, no one should attempt to make repairs at the component level or to make modifications to any printed wiring board. Improper repairs can create a safety hazard.

Safety Precautions for Modems

Always follow these basic safety precautions when using a modem or telephone that is not cordless.



WARNING: To reduce the risk of personal injury, electric shock, or fire:

- Never connect or use a modem or telephone during a lightning storm. There may be a remote risk of electric shock from lightning.
 - Never connect or use a modem or telephone in a wet location.
 - Never use a modem or telephone to report a gas leak in the vicinity of the leak.
 - Always disconnect the modem cable before opening the equipment enclosure or touching an uninsulated modem cable, jack, or internal components.
-

U.S. Regulations Governing the Use of Modems

This equipment complies with Part 68 of the FCC rules. Located on the bottom of the computer is a label that contains, among other information, the FCC Registration Number and Ringer Equivalence Number (REN) for this equipment. Upon request, you must provide this information to your telephone company.

The REN is useful to determine the quantity of devices you may connect to your telephone line and still have all of those devices ring when your telephone number is called. In most areas (but not all), the sum of the RENs of all devices connected to one line should not exceed five (5.0). To be certain of the number of devices you may connect to your telephone line, as determined by the REN, you should contact your local telephone company to determine the maximum REN for your calling area.

The REN for this device is 0.7B.

If your telephone equipment causes harm to the telephone network, the telephone company may discontinue your service temporarily. If possible, they will notify you in advance. But, if advance notice is not practical, you will be notified as soon as possible. You will also be informed of your right to file a complaint with the FCC.

Your telephone company may make changes in its facilities, equipment, operations, or procedures that could affect the proper functioning of your equipment. If they do, you will be notified in advance to give you an opportunity to maintain uninterrupted telephone service.

If you experience trouble with this telephone equipment, contact your local telephone company for information on obtaining service or repairs. The telephone company may ask that you disconnect this equipment from the network until the problem has been corrected or until you are sure that the equipment is not malfunctioning.

This equipment may not be used on coin service provided by the telephone company. Connection to party lines is subject to state tariffs.

For the Compaq Customer Support Center and your nearest Compaq Authorized reseller in North America, call 1-800-345-1518 or write:

Compaq Customer Support Center
P.O. Box 692000
Houston, Texas 77269-2000

Telephone Consumer Protection Act of 1991

The Telephone Consumer Protection Act of 1991 makes it unlawful for any person to use a computer or other electronic device to send any message via a telephone facsimile machine unless such message clearly contains, in a margin at the top or bottom of each transmitted page, or on the first page of the transmission, the date and time it is sent and an identification of the business, or entity, or individual sending the message and the telephone number of the sending machine or such business, or entity, or individual.

Canadian Regulations Governing the Use of Modems

NOTE: The Industry Canada label identifies certified equipment. This certification means that the equipment meets certain telecommunications network protective, operational, and safety requirements. The Department does not guarantee the equipment will operate to the user's satisfaction.

Before installing the equipment, users should ensure that it is permissible to be connected to the facilities of the local telecommunications company. The equipment must also be installed using an acceptable method of connection. In some cases, the company's inside wiring associated with a single line individual service may be extended by means of a certified connector assembly (telephone extension cord). The customer should be aware that compliance with the above conditions may not prevent degradation of service in some situations.

Repairs to certified equipment should be made by an authorized Canadian maintenance facility designated by the supplier. Any repairs or alterations made by the user to this equipment, or equipment malfunctions, may give the telecommunications company cause to request the user to disconnect the equipment.

Users should ensure for their own protection that the electrical ground connections of the power utility, telephone lines, and internal metallic water pipe system, if present, are connected together. This precaution may be particularly important in rural areas.



CAUTION: Users should not attempt to make such connections themselves, but should contact the appropriate electric inspection authority or an electrician.

The Load Number (LN) assigned to each terminal device denotes the percentage of the total load to be connected to a terminal loop which is used by the device to prevent overloading. The termination on a loop may consist of any combination of devices subject only to the requirement that the total of the Load Numbers of all devices does not exceed 100. An alphabetic suffix is also specified in the Load Number for the appropriate ringing type (A or B), if applicable. For example, LN = 20 A designates a Load Number of 20 and an “A” type ringer.

The Load Number for this device is 5B.

For the location of the authorized Canadian maintenance facility nearest you, call 1-800-263-5868 or contact:

Compaq Canada, Inc.
45 Vogell Road
Richmond Hill, Ontario LA5B 3P6

AUSTEL Requirements



CAUTION: Failure to set the modem, and any communications software used with the modem, to the values contained in the Telephone Answering Machine documentation will result in the modem being operated in a non-compliant manner. Consequently, there would be no permit in force for this equipment, and the Telecommunications Act 1991 prescribes a penalty of \$12,000 for the connection of non-permitted equipment.

Auto Dialing with the Modem

- 1 When entering telephone numbers, ensure that the number that appears on the screen is correct before beginning to dial.
- 2 Some parameters required for compliance with AUSTEL specifications are dependent on the Telecommunications apparatus provided with the Compaq Armada 7800 series of computers. The Compaq Armada 7000 Series II (Series 577) modem shall be set to operate within the following limits for compliance with AUSTEL Specifications.

When the user manually initiates a call via equipment connected to the Compaq personal computer, the equipment shall operate within the following restrictions:

- a Without call progress detection—a maximum of three calls (original plus two retries).
- b With call progress detection (which ensures the line will be released after detection of tones indicating the call will not be successful)—a maximum of ten calls (original plus nine retries).
- c If the series of calls noted in a or b are unsuccessful, no further attempts shall be made to obtain the required number within the next 30 minutes (unless manually initiated).

NOTE: Failure to meet the above requirements may negate user rights under the AUSTEL Terms of Service.

U.K. BABT User Information

Safety

The Compaq Armada 7000 Series II (Series 577) modem is intended for use in the Compaq Armada 7800 series of computers. For the purposes of BABT approval, the Compaq Armada 7000 Series II modem is classified as a host-independent product.

The following information characterizes the requirements of the host system in order to maintain the reliable use of the Compaq Armada 7000 Series II (Series 577) modem:

- The fax/voice modem requires a power supply voltage of 5VDC \pm 5%, 12VDC \pm 5%, or -12VDC \pm 5%.
- The host computer must provide a maximum of 950 mW (U.K.) from the +5VDC power supply, and a maximum of 50 mW from the -12VDC power supply and the +12VDC power supply.
- The host apparatus must provide adequate power for the modem and any other auxiliary apparatus drawing power from it.
- Failure to provide modem user's instructions with the host computer will INVALIDATE modem approval.
- The modem is approved only for installation in a host and with host attachments that are either type approved for such apparatus or, if supplied after 1st March 1989, are marked with or supplied with a statement that the host is supplied under General Approval Number NS/G/1234/J/100003.
- Connections to and from the modem card are made via the following port: DTE port (SELV) 80-pin edge connector on modem PCB.
- Ports for SELV circuitry should only be connected to like SELV circuitry ports.

Telephone Network Connection

- The modem is suitable for connection to the Public Switched Telephone Network (PSTN) direct exchange lines and relevant branch systems (PBXs).
- A ringer equivalent number (REN) is a value given to all apparatus to be connected to the PSTN. Its value can be taken and used to calculate the maximum number of equipment items that can be connected in parallel without impairing the performance of the standard bell circuit.

- $REN = 3/n$ where n is the maximum number of units that may be used in parallel.
- The maximum REN of a line is 4; therefore, the total REN of all apparatus connected to the line (obtained by summing the individual REN values) should not exceed 4. This value includes any BT-provided instrument, each of which is assumed to have REN value of 1.0 unless otherwise stated. Exceeding the $REN = 4$ value may cause your telephone(s) to ring weakly or not ring at all.
- Only one modem should be connected to a telephone line. Connecting a modem in parallel with one or more telephone instruments is not allowed.
- The REN for this piece of equipment is 1.0.
- The exchange should provide facilities for either loop disconnect (pulse) dialing or multifrequency (tone) dialing. The modem can be configured to operate with either system.
- During dialing, this apparatus may tinkle the bells of other telephones using the same line. This is not a fault, and we advise you not to call the Fault Repair Service.
- The Compaq Armada 7000 Series II (Series 577) modem specified in this guide is for the Compaq Armada 7800 series of computers.
- This apparatus has been approved for the following facilities:
 - Simple modem
 - Facsimile
 - Telephone answering machine functions
 - Speakerphone functions
 - Automatic call initiation
 - Detection of initial proceed indication
 - Automatic dialing
 - Tone detection of busy tone, dial tone, or number unobtainable tone
 - Auto clear from the call origination end
 - Loop disconnect (pulse) dialing
 - Multifrequency (tone) dialing

Any other usage will invalidate the approval of the apparatus if, as a result, it ceases to conform to the standards against which approval was granted.

All apparatus connected to this modem and, thereby, connected directly or indirectly to the British Telecom Public Switched Telephone Network, must be approved apparatus as defined in Section 16 of the British Telecommunications Act of 1981.

Although this equipment can use either loop disconnect or DTMF signaling, only the performance of the DTMF signaling is subject to regulatory requirements for correct operation. It is therefore strongly recommended that the equipment be set to use DTMF signaling for access to public or private emergency services. DTMF signaling also provides faster call setup.



CAUTION: The Compaq Armada 7000 Series II (Series 577) modem may not be used on extension wiring that makes use of plug pins 1 & 6. If in doubt, advice must be obtained from a competent telecommunications engineer.

Difficulties may occasionally be experienced from other apparatus connected to the BT PSTN via the Compaq Armada 7000 Series II modem apparatus. Such difficulties may include the following:

- Difficulty in making calls
- Problems in telephone conversion being experienced by both parties to the call



CAUTION: Initially, normal operation will be possible. However, changes to or modernization of the network may result in the apparatus being connected to a network service with which it was not designed to be compatible. Failure of the apparatus to work under these circumstances may not be the responsibility of the network operator.

If the above mentioned difficulties are experienced, please contact your product supplier or your authorized Compaq reseller in the United Kingdom.

This device is intended for auto-answering of incoming calls. Under normal conditions callers will be accustomed to calls being answered within 10 seconds, and a majority of callers will abandon calls that are not answered within 45 seconds.

There are several options available for auto-answering operation. The default setting is for two incoming rings. This is the recommended setting for normal operation by most computer users.

Auto Dialing with the Modem

When entering telephone numbers, ensure that the number that appears on the screen is correct before beginning to dial.

Approval Statements

The following lists the modem approval statements:

- This (Series 577) modem is approved as a host independent product. This approval number is a general approval number.
- APPROVED for connection to the telecommunications systems specified in the instructions for use, subject to the conditions set out in them.
- DGT No. NS/5141/3/V/607050.

appendix C

ELECTROSTATIC DISCHARGE

A discharge of static electricity from fingers or other electrostatic conductors may damage electronic components. Before handling electrostatic-sensitive components, discharge static electricity by one of the methods described in this appendix.

Preventing Electrostatic Discharge

When Handling Removable Drives

To prevent electrostatic damage to removable drives, observe these precautions:

- Before handling a removable drive, discharge static electricity by touching the unpainted metal surface or lug nuts on the connectors on the back of the computer.
- Avoid touching connector pins on the computer and on the removable drive.
- Keep a removable drive in its carrying case until you are ready to insert it into a drive bay.

When Installing Internal Components

To prevent electrostatic damage when installing internal components, observe these precautions:

- Keep components in their electrostatic-safe containers until you are ready to install them.
- Have everything needed for the installation within reach so that you do not have to leave the area after beginning installation.

- Use nonmagnetic tools.
- Before touching an electronic component, discharge static electricity by one of the grounding methods described later in this appendix. If you must leave the area during installation, remember to reground yourself before resuming installation.
- Avoid touching pins, leads, and circuitry. Handle electronic components as little as possible.
- If you remove a component, place it in an electrostatic-safe container.

Grounding Methods

There are several methods for grounding. Use one or more of the following grounding methods when installing components in the computer or expansion base.

- Touch the unpainted metal surface or lug nuts on the connectors on the back of the computer or expansion base. Avoid touching connector pins. If installation instructions direct you to unplug the computer or expansion base, unplug it after being properly grounded and before removing the cover.
- Touch an exterior unpainted metal surface of equipment that is connected to an electrical outlet by a grounding plug.
- Use a wrist strap connected by a ground cord to the computer chassis. Wrist straps are flexible grounding straps with a minimum of 1 megohm \pm 10 percent resistance in the ground cords. To provide proper ground, wear the strap snug against the skin.

NOTE: If you need more information about static electricity or assistance with product installation, contact your Compaq authorized dealer, reseller, or service provider.

appendix *D*

SPECIFICATIONS

The following guidelines provide a safe operating environment for your computer.

Operating Environment		
	U.S.	Metric
Temperature		
Operating	50 to 104°F	10 to 40°C
Nonoperating	-4 to 140°F	-20 to 60°C
Relative Humidity (noncondensing)		
Operating	10 to 90%	
Nonoperating	5 to 90%—38.7°C Maximum Wet Bulb	
Maximum Altitude (unpressurized)		
Operating	0-10,000 ft	3.05 km
Nonoperating	0-30,000 ft	9.14 km

Rated Input Power

Operating Voltage	100-120/220-240 VAC RMS
-------------------	-------------------------

Operating Current	1.2/0.6 A RMS
-------------------	---------------

Operating Frequency Range	50 to 60 Hz AC
---------------------------	----------------

NOTE: This product is designed for IT power systems in Norway with phase-to-phase voltage not exceeding 240 Vrms.

Computer Dimensions

Height	2.0 in	5.08 cm
--------	--------	---------

Width	17.75 in	45.09 cm
-------	----------	----------

Depth	10.25 in	26.04 cm
-------	----------	----------

INDEX

A

- AC Energy Saver, 4-12
- adjusting audio volume, 10-4
- analog signals, 7-10
- applications. *See* software
- audio
 - problems, 16-2, 16-3, 16-5
 - using speakers, 10-4
- audio, problems, 16-5
- Automobile Adapter, 5-7
- auxiliary battery, 16-8

B

- backup, 2-12
- battery, 16-8
- battery bay, 2-2
- battery components, 5-1
- battery gauge access, 3-10
- battery pack, 5-1
 - components, 2-2
- battery power light, 2-8, 16-6
- battery release latch, 2-9
- battery, problems, 16-6, 16-7, 16-8
- beeps, 5-4, 5-16, 5-17, 16-6
 - system, 3-7
- BIOS version number, 3-12
- blank screen, 16-28, 16-30
- blinking battery power light, 16-6
- boot, 15-6
- brightness control, 3-11

C

- caring for EasyPoint III pointing device, 12-2
- CD, 6-13, 6-14, 6-15, 6-16
- CD-ROM drive
 - problems, 16-10, 16-11
- cellular
 - airtime, 7-13
 - cable, 7-13
 - equipment, 7-13
 - software, 7-13

- cellular phone
 - problems, 16-35
- charging battery packs
 - problems, 16-6
- command mode, 7-11, 7-12
- Compaq Diagnostics, 15-5, A-1
- Compaq phone numbers, A-2
- Compaq Support, A-1
- Compaq Utilities, 15-3
- components, 2-2, 5-1
 - front, 2-2
 - keyboard, 3-3
 - top, 2-8
- computer
 - opening for first time, 1-7
 - serial number, A-1
 - turning on, 1-8
- Computer Checkup (TEST), 15-4
- Computer Setup, 15-1, 15-2, 15-3
- computer will not turn on, 16-26
- connecting three-to-two-prong plug adapter, 1-6
- connector, power, 1-6
- controlling brightness, 3-11
- critical low battery, 4-9
- cursor keys, 3-3
- customer support, A-2

D

- damage, preventing
 - from electrostatic discharge, C-1
 - internal components, C-1
 - removable drives, C-1
- date and time, 16-8
- diagnostics, 15-4, 15-5
- digital line, 7-3, 7-4
- dim characters, 16-28
- diskette
 - inserting into diskette drive, 6-21
- diskette drive
 - inserting diskette into, 6-21
 - problems, 16-12, 16-16
- display
 - problems, 16-21, 16-28, 16-30
- DOS. *See* MS-DOS
- drivers. *See* device drivers

E

EasyPoint III, 12-2
electrostatic discharge, C-1
embedded numeric keypad
 accessing, 3-13
 problems, 16-21
energy saving, 3-9
error, hard drive, 16-15
ESD. *See* electrostatic discharge
external microphone problems, 16-3
external monitor problems, 16-30
external speakers, using, 10-4

F

fan, 2-3
floppy disk drive. *See* diskette drive
Fn key, 3-3
front components, 2-2
function keys, 3-3

G

grounding methods, C-2

H

hard drive
 identifying, 2-2
 problems, 16-15, 16-16
hard drive bay, 2-2, 6-6
hard drive release latch, 2-9
hard drive, problems, 16-15, 16-16
headphone problems, 16-5
headphones, 10-4
hotkeys, 3-3, 3-4, 3-5, 3-7, 3-9, 3-12,
 3-13, 3-14
HyperTerminal, 7-12

I

I/O address. *See* input/output address
inactivity, 4-11
inaudible dial tone, 16-34
infrared, problems, 16-17, 16-18, 16-20
inserting
 diskette into diskette drive, 6-21
INSPECT, 15-5

Intelligent Manageability, 14-1
 Asset Management, 14-2
 asset tag, changing, 14-2
 Configuration Management, 14-4
 diagnostic information, 14-2
 Fault Management, 14-3
 inventory information, 14-2
 Security Management, 14-4
internal microphone, 10-2
internal speakers
 problems, 16-2
 using, 10-4
IRQ. *See* interrupt requests

K

keyboard, 2-8, 3-7
 components, 3-3
 problems, 16-21
keyboard/mouse connector, 2-5
keypad
 embedded numeric, 3-13
 problems, 16-21

L

left mouse button, 2-8
light, 2-8
locating components, 2-2, 2-8, 3-3
login password, 13-1
low battery, 16-6, 16-27

M

memory insulator, 11-5, 11-7
memory, problems, 16-7
microphone, 2-1, 10-3
microphone jack, 10-6, 10-7
modem cable, problems, 16-36
modem commands, editing, 7-2
modem, problems, 16-33, 16-34,
 16-35, 16-36, 16-37, 16-38
monitor, problems, 16-30
MPEG, 2-11
MultiBay, 2-2, 5-12, 6-7, 6-8, 6-9,
 6-10, 6-11, 6-12, 6-17, 6-19
MultiBay release latch, 2-9
MultiBay weight saver, 6-3

N

network PC Card problems, 16-24
new battery, 5-2
normal, 5-3
number, serial, A-1
numeric keypad, 3-3, 3-13
 problems, 16-21

P

PaqFax, A-2
parallel connector, 2-5
passwords, 13-3, 13-6, 13-13,
 13-15, 13-16
PC Card (PCMCIA)
 problems, 16-22, 16-23,
 16-24, 16-25
PCMCIA. *See* PC Cards
phone numbers, worldwide, A-2
plugging in computer
 in country where purchased, 1-6
 pointing device, 2-8, 3-2, 3-3, 12-2
 popup window location hotkey, 3-5
POST. *See* Power-on Self-Test
power
 conservation, 3-9
 light, 2-8
 management, 3-9
 problems, 16-26, 16-27
 switch, 2-8
power connector, 1-6
power cord
 connecting, 1-6
 safety precautions, 1-6
Power-On Self-Test, problem, 16-2
problem solving. *See* troubleshooting
product identification number
 (PIN), A-1
Programmable Keys, 3-15, 3-16,
 3-17, 3-18

Q

quick controls, 13-10
QuickLock/QuickBlank, 13-10, 13-11

R

RAM, 11-1. *See* random access
 memory
receiving calls, 7-19
removable drives, C-1
replacing pointing device cap, 12-2
restarting computer, 16-15
right mouse button, 2-8
RJ-11 jack, 7-3
ROM. *See* read only memory

S

S registers
 changing, 7-9
 defaults, 7-9
 modifying, 7-9
saving energy, 3-9
screen
 control keys, 3-3
 problems, 16-21, 16-28, 16-30
SDRAM, 11-2
security, 13-1, 13-2, 13-3, 13-4, 13-6,
 13-10, 13-11, 13-13, 13-14,
 13-15, 13-16, 13-18
serial connector, 2-5
serial number, 2-9
serial number, computer, A-1
setup password, 13-6, 13-7, 13-8
short battery charge, 16-8
signal strength, 7-18
software drivers. *See* device drivers
software, backup, 2-12
solving problems. *See* troubleshooting
sound, problems, 16-2, 16-3, 16-5
speakers, 2-2
 location, 2-2
 problems, 16-2
 using, 10-4
static electricity. *See* electrostatic
 discharge
stereo, 10-4, 10-5
stereo line-in jack, 2-4, 10-6
storage PC Card problems, 16-25
support, Compaq, A-1
Suspend, 7-19
suspend button, 2-7
switch, power, 2-8
system information, 15-5

T

telephone numbers, worldwide, A-2
telephony, problems, 16-36
TEST, 15-4. *See also* Computer
 Checkup (TEST)
text stretch, 3-14
three-to-two-prong plug adapter, 1-6
time and date, 16-8
timeout, 4-9, 4-11
top components, 2-8
turning on computer for first time, 1-8
twenty five-pin connector, 2-6, 7-4

U

Universal Serial Bus (USB), 2-11
USB, problems, 16-31, 16-32
user password, 13-12

V

volume, problems, 16-2, 16-3, 16-5

W

Windows 95, problems, 16-35, 16-37
worldwide phone numbers, A-2

Z

Zoomed Video, 9-7