

---

# Notice

The information in this guide is subject to change without notice.

COMPAQ COMPUTER CORPORATION SHALL NOT BE LIABLE FOR TECHNICAL OR EDITORIAL ERRORS OR OMISSIONS CONTAINED HEREIN; NOR FOR INCIDENTAL OR CONSEQUENTIAL DAMAGES RESULTING FROM THE FURNISHING, PERFORMANCE, OR USE OF THIS MATERIAL.

This guide contains information protected by copyright. No part of this guide may be photocopied or reproduced in any form without prior written consent from Compaq Computer Corporation.

© 1998 Compaq Computer Corporation.  
All rights reserved. Printed in the U.S.A.

COMPAQ, ARMADA, and LTE are registered in the U. S. Patent and Trademark Office.

Microsoft, MS-DOS, Windows, and Windows NT are registered trademarks of Microsoft Corporation.

The software described in this guide is furnished under a license agreement or nondisclosure agreement. The software may be used or copied only in accordance with the terms of the agreement.

Product names mentioned herein may be trademarks and/or registered trademarks of their respective companies.

## ***Maintenance and Service Guide***

### **Compaq Armada 6500 Family of Personal Computers**

First Edition October 1998  
Documentation Part Number 388103-001  
Compaq Spare Part Number 358999-001  
DEC Spare Part Number ER-PM1CC-SR.A01

**Compaq Computer Corporation**

---

.....

# Contents

## *Preface*

Symbols.....	ix
Technician Notes .....	ix
Serial Number .....	x
Locating Additional Information.....	x

## *Chapter 1* **Overview**

1.1 System Overview .....	1-1
CPU .....	1-1
Chip Set .....	1-2
Memory .....	1-2
BIOS .....	1-3
PCI Bus Devices .....	1-3
CardBus Controller .....	1-3
Video Controller Chip.....	1-4
ISA Bus Devices .....	1-4
Audio .....	1-4
BIOS .....	1-5
System Command Processor.....	1-5
Super I/O .....	1-6
UMI Controller .....	1-6
1.2 Docking Options .....	1-7
Mobile 6500 Expansion Unit.....	1-7
Armada 6500 Convenience Base .....	1-7
1.3 Components, Controls, and Indicators .....	1-8
Front and Right Side Components.....	1-8
T .....	1-10
Rear Components .....	1-12
Bottom Components .....	1-13
1.4 Controlling Power.....	1-14
1.5 LCD Status Display .....	1-15
1.6 Keyboard Hot Keys .....	1-16
1.7 Related Information .....	1-18
Documentation .....	1-18
World Wide Web .....	1-18

.....

## *Chapter 2* **System BIOS**

2.1	Running System Setup .....	2-1
	System Setup Utility .....	2-1
2.2	Updating the Computer's Configuration .....	2-2
	Helpful Hints.....	2-3
	Launching Submenus.....	2-3
2.3	Main Menu.....	2-4
2.4	Advanced Menu.....	2-5
	I/O Device Configuration Submenu .....	2-6
2.5	Security Menu.....	2-7
	Security .....	2-8
2.6	Power Menu.....	2-11
2.7	Boot Menu .....	2-12
2.8	Exit Menu .....	2-13
2.9	Restoring the Flash BIOS—Place Holder.....	2-13

## *Chapter 3* **Troubleshooting**

3.1	Troubleshooting Tips.....	3-1
	System Start Failure.....	3-2
	Power Supply Failure.....	3-3
	Boot-up Failure .....	3-4
	POST Failure .....	3-4
	Cardbus Failure.....	3-4
	LCD Panel Failure .....	3-5
	CRT Failure .....	3-5
	Computer Keyboard Failure .....	3-6
	External Keyboard or PS/2 Mouse Failure.....	3-6
	Hard Drive Failure .....	3-6
	Diskette Drive Failure.....	3-7
	CD-ROM Failure .....	3-7
	Battery Failure .....	3-8
	Touchpad Failure .....	3-8
	Internal Modem/Network (UMI) Failure .....	3-8
	External Audio Failure.....	3-9
3.2	Check Points and Error Messages .....	3-9
	Phoenix BIOS Test Points .....	3-9
	Warning Messages .....	3-14

.....

*Chapter 4*  
**FRU Replacement**

4.1 Introduction.....	4-1
4.2 Required Tools.....	4-1
4.3 Service Options.....	4-1
4.4 Preparing the Computer for Disassembly.....	4-7
Removing the Main Battery.....	4-7
Removing MultiBay Devices.....	4-9
Removing Memory.....	4-11
Removing the Internal Modem/Ethernet Combo Card.....	4-13
4.5 Removing the Keyboard.....	4-16
4.6 Removing the Hard Drive Assembly.....	4-19
4.7 Removing the LCD Assembly.....	4-20
4.8 CPU Base Enclosure with System Board Replacement.....	4-22
Disassembly Instruction.....	4-22
Customer System Reconfiguration.....	4-24

*Appendix A*  
**Specifications**

System Specifications.....	A-1
Hardware Specifications.....	A-1
Physical Specifications.....	A-2
Environment.....	A-2

*Appendix B*  
**Device Mapping**

Memory Map.....	B-1
DMA Channel Assignments.....	B-1
Notebook Computer Interrupt Levels.....	B-2
I/O Address Map.....	B-3

---

## Preface

This maintenance and service guide is a troubleshooting reference that can be used when servicing the Compaq Armada 6500 Family of Personal Computers.

Compaq Computer Corporation reserves the right to make changes to the Compaq Armada 6500 Family of Personal Computers without notice.

Additional information is available on the *Compaq Armada 6500 Family of Personal Computers Illustrated Parts Map*.

## Symbols

The following words and symbols mark special messages throughout this guide:



**WARNING:** Text set off in this manner indicates that failure to follow directions in the warning could result in bodily harm or loss of life.



**CAUTION:** Text set off in this manner indicates that failure to follow directions in the caution could result in damage to equipment or loss of information.

---

**IMPORTANT:** Text set off in this manner presents clarifying information or specific instructions.

**NOTE:** Text set off in this manner presents commentary, sidelights, or interesting points of information.

## Technician Notes



**WARNING:** Only authorized technicians trained by Compaq should repair this equipment. All troubleshooting and repair procedures are detailed to allow only subassembly/module level repair. Because of the complexity of the individual boards and subassemblies, no one should attempt to make repairs at the component level or to make modifications to any printed wiring board. Improper repairs can create a safety hazard. Any indication of component replacement or printed wiring board modifications may void any warranty or exchange allowances.



**WARNING:** The computer is designed to be electrically grounded. To ensure proper operation, plug the AC power cord into a properly grounded electrical outlet only.



**CAUTION:** To properly ventilate the system, you must provide at least 3 inches (7.62 cm) of clearance on the left and right sides of the computer.

---

---

## Serial Number

When requesting information or ordering spare parts, provide the computer serial number. The serial number is on the bottom of the computer.

## Locating Additional Information

In addition to this guide, the following documentation provides information for the computer:

- Compaq Armada 6500 Family of Personal Computers documentation set
- Microsoft *Windows 95/Windows NT 4.0 User's Guide*
- Compaq Service Training Guides
- Compaq Service Advisories and Bulletins
- *Compaq QuickFind*
- *Compaq Service Quick Reference Guide*
- *Compaq Armada 6500 Family of Personal Computers Illustrated Parts Map*
- Compaq Internet site at <http://www.Compaq.com>

# Overview

This chapter introduces the Compaq Armada 6500 notebook computer. It provides a computer system overview and describes the controls, indicators, and hot keys.

## 1.1 System Overview

The computer is a high-performance portable computer designed for the mobile professional.

### CPU

The computer supports the Intel Mobile 300-MHz Pentium II processor. The following is a list of the general features of this processor:

- Dynamic Execution micro architecture.
- Multiprocessing System Bus technology.
- Multiple low-power states (AutoHALT, Stop Grant, Sleep and Deep Sleep) to conserve power during idle times.
- 32-bit address bus.
- 64-bit data bus.
- 32KB internal write-back cache.
- Capable of executing two instructions per clock cycle using two pipelined integer units.
- Multimedia extension (MMX) register set.

.....

## Chip Set

The Intel 440BX AGPset is used to implement the core functions of the system. The 440BX AGPset includes the Intel 82443BX and the Intel PIIX4.

- The Intel 82443BX chip provides the core system functions.
  - Processor/host bus support: Optimized for Pentium II processor at 100MHz; support for 66MHz.
  - 3.3V core and mixed 3.3V and GTL I/O.
  - Integrated DRAM controller.
  - PCI bus interface.
  - AGP interface.
  - Advanced Power Management.
  - Supporting I/O Bridge.
- The Intel PIIX4 provides the PCI to ISA bridge interface.
  - Multifunction PCI-to-ISA bridge.
  - Power Management Logic.
  - Integrated PCI IDE Controller
  - Enhanced DMA Controller.
  - Interrupt Controller Based on two 82C59.
  - Timers based on 82C54.
  - USB
  - Real-Time Clock

## Memory

The system comes with 64MB of on-board SDRAM for system memory and 512KB of L2 cache memory.

System memory can be upgraded to a total of 192MB or greater. The upgrade is performed by installing 32MB or 64MB SDRAM SO-DIMMs. There are two slots for additional memory. Memory can be upgraded one module at a time. Either slot can be populated first.



---

## **BIOS**

The system has an Intel 28F004BV-T 4MBIT Boot block Flash ROM for system BIOS. BIOS provides support for the following:

- Suspend to RAM.
- Save to Disk.
- APM 1.2, DMI2.0 and ACPI compliant.
- Password protection (System and Docking options).
- Auto-configured with docking options.
- Windows 95 ready with PnP.
- Various hot-keys for system control.

## **PCI Bus Devices**

The internal PCI bus and PCI components operate at 3.3V.

## **CardBus Controller**

CardBus support is provided by the TI PCI1221 PC CARD controller. This chip provides the following functions:

- Support for Zoomed Video.
- Support for two PC Card/CardBus slots with hot removal/insertion.
- Uses burst transfers to maximize data throughput on the PCI/CardBus bus.
- Supports Parallel PCI Interrupts, Parallel ISA IRQ and Parallel PCI Interrupts, Serial ISA IRQ with Parallel PCI Interrupts, and Serial ISA IRQ and PCI Interrupts.
- ACPI Compliant.
- Supports Ring Indicate, Suspend, PCI CLKRUN and CCLKRUN.

.....

## Video Controller Chip

Video support is provided by the ATI Rage LT Pro-AGP Controller Chip. This chip provides the following functions:

- Comprehensive support for Accelerated Graphics Port including 1X or 2X mode with sidebands.
- TFT panel interface support for up to 1280 × 1024 resolutions.
- 64-bit memory interface.
- 4MB 3.3V Video SGRAM.
- Support for Zoomed Video.
- DDC1 and DDC2B+ support for PnP monitors.
- Advanced power management features minimize power consumption during:
  - Normal operation
  - Standby mode
  - Panel-off

## ISA Bus Devices

The ISA bus interface is provided by the Intel PIIX4 chip.

## Audio

Audio support is provided by the ESS Maestro-2+ audio accelerator. This chip provides the following functions:

- 500-MIPS-equivalent dual-engine PCI audio accelerator.
- 64-Voice wavetable synthesis.
- I<sup>2</sup>S Zoomed Video interface.
- DVD AC-3 (S/P DIF) audio decoding and AC-3 speaker virtualization.
- Docking solution backward compatible with ES978 mixer.

.....

## BIOS

The system BIOS is implemented using the Intel 28F004BV-T 4MBIT Boot block Flash ROM.

## System Command Processor

The System Command Processor is implemented using the Hitachi H8/3434 processor. This processor provides the following functions:

- Simultaneous support of two external PS/2 ports and the internal Touch pad.
- I<sup>2</sup>C bus master for communication to:
  - Status LCD
  - EEPROM
  - Docking interface components
- Hot Key interface.
- Secure password protection.
- System power plane control and power sequencing.
- Battery management interface for charging and the Smart battery information.
- Status LCD and device monitoring interface.
- Active thermal interface for CPU thermal management.
- Internal keyboard scanning.

.....

## **Super I/O**

I/O support is provided by the National Semiconductor PC97338 chip. This chip supports the following functions:

- Floppy disk controller with Japanese floppy support.
- IEEE 1284 compliant bi-directional parallel port.
- Serial infrared support – IrDa 1.1 (115Kbps and 4Mbps).
- 16550A and 16450 UARTs.
- Full Plug-and-Play support.

## **UMI Controller**

The computer has an internal type II PCMCIA slot that is available as an UMI slot. This feature provides a flexible method for the support of an internal modem/Ethernet Combo card. This slot supports only Compaq approved ISA 16-bit cards. The UMI interface is provided by the TI PCI1221 controller. This chip provides the following features and functions:

- PCI Power Management, ACPI 1.0 and 1995 PC Card Standard compliant.
- Advanced Submicron, Low-Power CMOS Technology.
- Pipelined architecture provides greater than 130-MB/s throughput.
- Five PCI memory windows and two I/O windows.

---

## 1.2 Docking Options

The computer supports the docking options described below.

### Mobile 6500 Expansion Unit

The Mobile 6500 Expansion Unit has the following features:

- Three speakers: two tweeters and one sub-woofer.
- Line-in and speaker out support.
- MIDI/Joystick port.
- Dolby Digital Surround Sound (S/P DIF).
- 17mm MultiBay supporting CD-ROM, DVD-ROM, hard drive, LS-120, ZIP, and diskette drives.
- Video output (NTSC/PAL selectable).
  - Composite video using RCA jack
  - S-Video
- Hardware Volume Control

### Armada 6500 Convenience Base

The Armada 6500 Convenience Base has the following features:

- Battery charger
- Parallel port
- Serial port
- VGA/CRT port
- Two PS/2 connections for keyboard and mouse
- USB port
- RJ45 10/100BaseT Network Interface

---

## 1.3 Components, Controls, and Indicators

This section shows the locations and provides a description of the different components on the computer.

### Front and Right Side Components

Item	Component	Description
1	Power LED Battery Charging LED	The green Power LED (lower) lights when the computer is on. The amber Battery Charging LED (upper) lights when the battery is charging.
2	Lid Release	One of two lid releases. Push in both releases at the same time to open the LCD panel.
3	Speaker	Right stereo speaker used to hear sound files and system sounds.
4	MultiBay	Supports CD-ROM, diskette, and optional drives (DVD-ROM, LS-120, and hard drive).
5	Microphone In	Input connection for external microphone.
6	Audio Out	Connection for headphones or external speakers.
7	Suspend/Power Button	Turns the computer On, and Suspends or Resumes the system. Refer to the "Controlling Power" section of this chapter for detailed instructions on using the Suspend/Power button.
8	Internal Microphone	Used to record voice, music, and sound files.
9	Status Display	Provides system operating status.

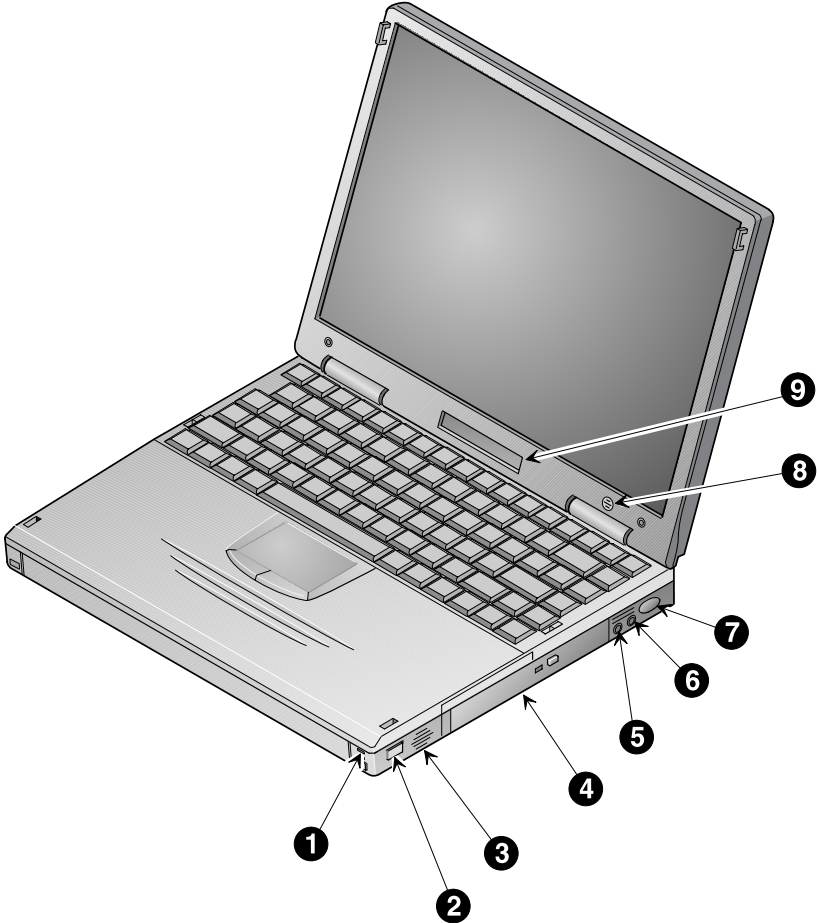

**Figure 1-1** Front and Right Side View

DEC01547-2

---

## Top and Left Side Components

Item	Component	Description
1	Lid Release	One of two lid releases. Push in both releases at the same time to open the LCD panel.
2	Speaker	Left stereo speaker used to hear sound files and system sounds.
3	PC Card Ejectors	Ejects a PC Card. Top button releases a PC Card from the top slot; the bottom button releases a PC Card from the bottom slot.
4	PC Card Slots	Supports two Type I or Type II cards or one Type III card. Zoomed Video cards are supported in the bottom slot only.
5	Keyboard Releases	These latches release the keyboard to allow access to the removable hard drive.
6	Removable Hard Drive	Located under the keyboard, the hard drive is easily removable and upgradeable. See Chapter 5, System Upgrades for removal instructions.
7	Security Lock	Attach a security locking device , such as a Kensington lock, to this port.



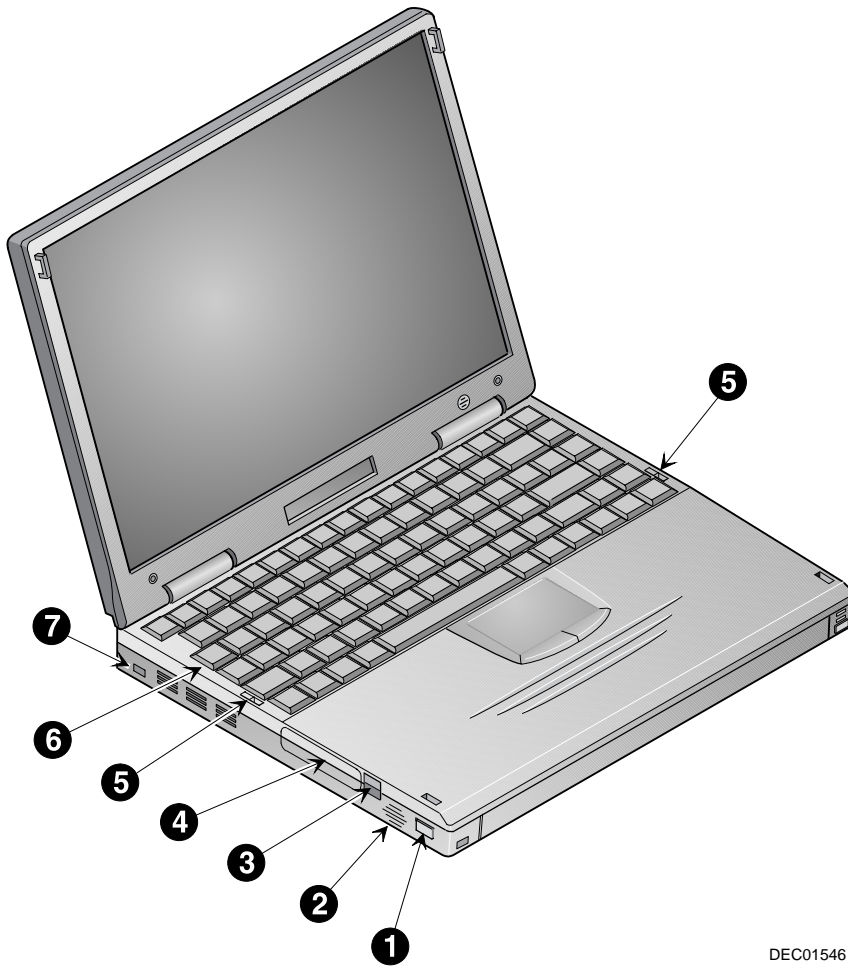

DEC01546

**Figure 1-2** Top and Left Side View

## Rear Components

Item	Component	Description
1	External Power In	Input connection for Universal AC adapter.
2	Universal Serial Bus (USB) Port	A USB device, such as a mouse, keyboard, or digital camera connects to this port.
3	RJ45 Ethernet Network Port	A 10 or 100BaseT Ethernet line connects to this port.
4	RJ11 Modem Port	An analog telephone line connects to this port.
5	Serial Port	A serial device, such as a mouse, graphics tablet or scanner connects to this port.
6	Parallel Port	A parallel device, such as a printer, connects to this port.
7	Video Port	An external monitor connects to this port.
8	I/O Connector Cover and Notebook Support	Covers I/O connectors. It can be flipped down to support the computer to create a comfortable typing angle (Figure 2-6, step 4).
9	Fast IR Port	Fast IR interface allows wireless data transfer between the computer and another device with an IR interface.
10	Reset Button	Resets the computer. <b>All unsaved data will be lost.</b>
11	External Keyboard/ Mouse Port	An external keyboard or PS/2 mouse connects to this port.

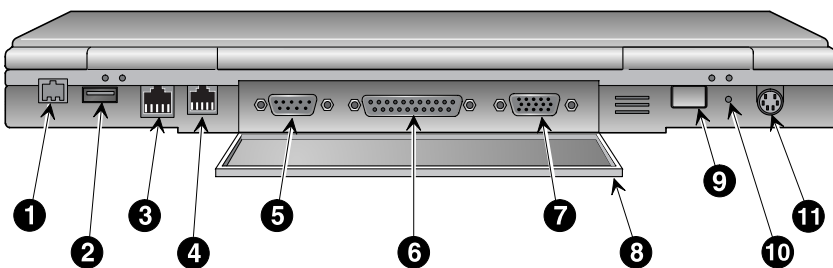

DEC01600

Figure 1-3 Rear View

---

## Bottom Components

Item	Component	Description
1	Battery Release	Releases the Lilon battery from the computer.
2	Lilon Battery	Provides power to the computer.
3	MultiBay Release	Releases the drive installed in the MultiBay.
4	Memory Door	Provides access to computer's memory.
5	Docking Connector Door	Provides access to the computer's docking connector. This connector is used when connecting the computer to the Compaq Mobile 6500 Expansion Unit or the Compaq Armada 6500 Convenience Base.

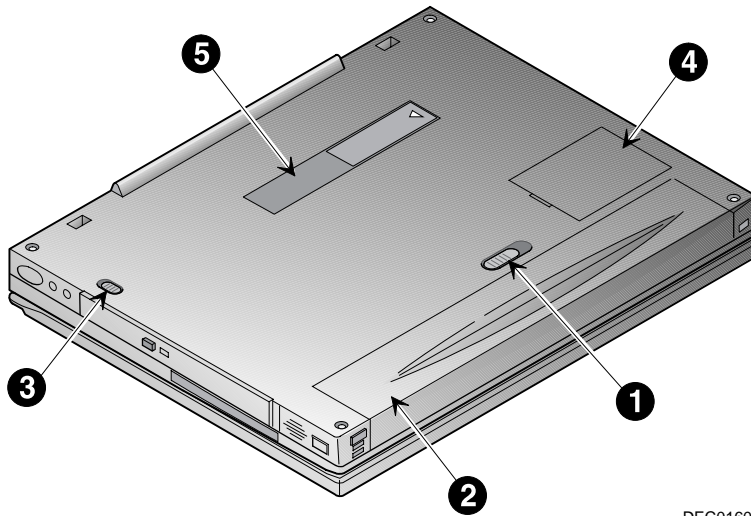







DEC01601

**Figure 1-4** Bottom View









## 1.4 Controlling Power

The Suspend/Power button turns the computer on and off and accesses the built-in power saving features.

Goal	Action
On/Resume 	Press this button to turn the system On or resume normal operation from the Suspend mode.
Suspend 	Press this button to place the system in Suspend mode.
Lid Switch	Close the LCD panel to place the system into Suspend mode. If the Lid Switch option in System Setup is set to Desktop/CRT, closing the LCD panel will turn off the LCD screen and prevent the computer from entering Suspend mode. This allows the computer to function as a desktop computer (computer LCD panel closed) using an external display, keyboard, and mouse.
Off (Windows 95 and Windows NT)  + 	Press <b>Fn +</b> the Suspend/Power key combination to completely shut off the computer from any state. If Windows is up and running, it is recommended that the computer always be turned off as outlined in the Introducing Microsoft Windows user's guide which was packaged with the computer.
Off (Windows 98)  + 	Press <b>Fn +</b> Suspend/Power key combination to initiate an Off request and allow Windows 98 to shut off the computer.
Power Button Override 	Press and hold the Suspend/Power button <b>for four seconds</b> to completely shut Off the computer from any state. If Windows is up and running, it is recommended that the computer always be turned off as outlined in the Introducing Microsoft Windows user's guide which was packaged with the computer.

---

## 1.5 LCD Status Display

Indicator	Shows...
	External power – The computer is connected to and operating from its external AC power supply.
	Standby – The computer is in Standby Mode. Any system activity such as, pressing a key on the keyboard, touch pad, mouse, or other system activity resumes normal operation.
	Hard drive/MultiBay activity – The hard drive or the drive installed in the MultiBay is being accessed.
	Caps lock – The Caps Lock function is enabled.
 Blinking	Keyboard/mouse lock – When the caps lock icon is blinking, it indicates that the keyboard/mouse lock is enabled. To resume keyboard/mouse activity, enter the User password defined in the System Setup Program.
	NUM lock – The NUM Lock function is enabled.
	Video port enabled – The external monitor port is enabled.
	Scroll lock – The Scroll Lock function is enabled.
	Embedded numeric key pad lock – The keyboard's embedded key pad is enabled.

## 1.6 Keyboard Hot Keys

The hot keys are used to set up and control the computer. These keys are activated by holding down the **Fn** key and pressing the desired function key. The following table shows each hot key sequence and describes its function:

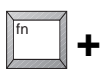

+

### Function



Places the computer in Standby Mode.



Sets the computer's operating mode to maximize battery life. A single beep is emitted when the computer switches to this operating mode. If the computer is restarted, the system returns to the settings contained in the System Setup Program.



Sets the computer's operating mode to maximize performance. Two beeps are emitted when the computer switches to this operating mode. If the computer is restarted, the system returns to the settings contained in the System Setup Program.



Used during Power Up Self-Test (POST) to enter the System Setup Program.



Enables and disables the computers external display port and the LCD display. There are three display modes:

LCD Display

LCD Display and External Monitor (simulscan)

External Display

Each time this hot key combination is pressed, the computer changes to the next display setting.



Reserved for future use.



Enables the Keyboard/Mouse Lock. To use this feature, a user password must be set. When Keyboard/Mouse Lock is enabled, the Enter Password prompt will appear on the screen and the Caps Lock icon found on the LCD Status Display will blink. Enter the user password to disable the Keyboard/Mouse Lock.



Toggles the system sound between mute and on.



Enables and disables the keyboard's embedded key pad.

*continued*



**Keyboard Hotkeys** *(continued)*

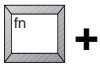

+

**Function**



Toggles NUM Lock on and off. The computer offers two numeric input methods:

**On-the-fly Numeric Input:**

While Num Lock is enabled, press the **Fn** key to activate the embedded key pad for numeric input. Release the **Fn** key to disable the embedded key pad and return the keyboard to normal operation.

**Intensive Numeric Input:**

When **Fn + F9** is used in conjunction with **Fn + F8**, the embedded key pad is locked for intensive numeric input. Disable the embedded keypad to return the keyboard to normal operation.



Toggles Scroll Lock On and Off. The Scroll Lock feature is application dependent; consult the software user's guide for more information on using Scroll Lock.



Increases the audio volume.



Decreases the audio volume.



Decreases the LCD screen brightness.



Increases the LCD screen brightness.

.....

## 1.7 Related Information

### Documentation

Compaq Armada 6500 Family Reference Guide      ER-PM1CC-UA

*Quick Setup Guide*      ER-PM1CC-IM

### World Wide Web

Information such as drivers, BIOS updates, and on-line documentation is available from Compaq's World Wide Web Site. The URL for the site is:

[HTTP://WWW.COMPAQ.COM/](http://WWW.COMPAQ.COM/)



# System BIOS

This chapter provides information on how to configure the computer and its security features using the System Setup Program. The computer is configured with default settings selected for typical use.

If you are familiar with System Setup programs, refer to the appropriate sections in this chapter for information on configuring or updating the computer. Otherwise, carefully read this chapter before attempting to modify the computer's configuration and security settings.

Here are some instances when you might want to change the computer's System Setup. You might need to:

- Change the date and time
- Change the computer's security level
- Enable/disable and configure power management
- Enable the infrared port or other devices
- Enable boot device options

## 2.1 Running System Setup

The System Setup Program enables you to select and store information about the computer's hardware configuration, boot sequence, security, and power management features. This information is stored in the computer's battery backed-up CMOS RAM.

### System Setup Utility

To run System Setup:

1. Turn on or reboot the computer.
2. During system boot, press **Fn + F3** when the Compaq logo appears. When the logo appears you have approximately 4 seconds to enter System Setup.

---

## 2.2 Updating the Computer's Configuration

There are a number of hardware features that can be configured on the computer.

<b>Menu</b>	<b>Configurable Features</b>
Main	System Time System Date Lid Switch Mode Primary Master Primary Slave Secondary Master
Advanced	Secured Setup Configurations I/O Device Configuration Reset Configuration Data Large Disk Access Mode SMART Device Monitoring TV Mode
Security	Set Supervisor Password Set User Password Password on boot Password on undock Password on resume
Power	Power Savings Idle Mode Standby Timeout Auto Suspend Timeout Suspend Mode Hard Disk Timeout Video Timeout Cooling Mode Resume On Time Resume Time Resume Date
Boot	Summary Screen Diskette Drive Check Boot Device Priority
Exit	Exit Saving Changes Exit Discarding Changes Load Setup Defaults Discard Changes Save Custom Defaults Load Custom Defaults Save Changes

---

## Helpful Hints

There are several keyboard keys assigned to help you select menus and sub-menus, options, and to change option values.

Legend Key	Alternate Key	Function
F1	Alt + H	Displays the General Help window.
ESC	Alt + X	Exits the current menu and returns you to the previous screen.
← or →		Selects a different menu bar item.
↑ or ↓		Moves the cursor up and down between fields.
F5	- (minus key)	Scrolls backwards through the values of the highlighted field.
F6	+ (plus key) <space bar>	Scrolls forward through the values of the highlighted field.
F9		Sets the fields for the active menu to their default values.
F10		Saves the new configuration and exits the System Setup.
Press Enter		Executes commands, selects submenus, selects fields, or displays available options.

## Launching Submenus

Notice that a pointer symbol appears next to selected fields in the menu screens. For example, see the I/O Device Configuration option in the Advanced menu. The symbol indicates the existence of a submenu that can be launched for more advanced configuration options. To launch a submenu:

1. Move the highlighted cell to the desired Menu Bar item and press **Enter**.
2. Use the legend keys to navigate around the screen and make the needed configuration changes.
3. When you finish, press the **Esc** key to exit the submenu and return to the main screen.

---

## 2.3 Main Menu

Feature	Settings	Comments
System Time	Enter current time: hour, minute, second format.	Sets the system to specified time.
System Date	Enter current date: month, day, year format.	Sets the system to specified date.
Diskette	Display only field	Indicates the computer is configured to support a 1.44/1.25MB 3 1/2 " diskette drive.
Lid Switch	Suspend/Resume* Desktop/CRT	This option allows you to configure the way the computer responds when opening and closing the LCD display panel. When Suspend/Resume is selected, the system enters Suspend Mode when the lid is closed and Resumes operation when the lid is opened. When Desktop/CRT mode is selected, the external video port is enabled when the lid is closed.
Primary Master	Display only field	Description of hard drive.
Primary Slave	Display only field	Description of IDE device installed in the computer's MultiBay.
Secondary Master	Display only field	Description of IDE device installed in Compaq Mobile 6500 Expansion Unit.
System Memory	Display only field	Indicates the amount of conventional memory used by the system.
Extended Memory	Display only field	Indicates the amount of RAM, minus conventional memory (640KB) and high memory (360KB), installed in the system.
System BIOS version	Display only field	Indicates the current System BIOS version.
Keyboard BIOS version	Display only field	Indicates the current Keyboard BIOS version.

\*Factory default setting

---

## 2.4 Advanced Menu

Field	Settings	Comments
Secured Setup Configurations	No* Yes	Select Yes to prevent a Plug and Play Operating System from changing system settings.
I/O Device Configuration	Submenu	Peripheral Device Configuration: Refer to I/O Device Configuration Submenu for a description of the available settings.
Reset Configuration Data	No* Yes	Select Yes to clear all Plug and Play configuration information stored in Extended System Configuration Data non-volatile RAM.
Large Disk Access Mode	Other DOS*	Select Other if a non-Microsoft operating system is installed on the system. If you install new o/s software and the drive fails, change this selection and try again. Different operating systems require different representations of drive geometries.
SMART Device Monitoring	Disabled Enabled*	Enables/Disables IDE Failure Prediction.
TV Mode	Selected Formats	This option allows you to specify the video output format supported by your country when using the video ports provided on the Mobile 6500 Expansion Unit.

\*Factory default setting

## I/O Device Configuration Submenu

Field	Settings	Comments
Serial Port	Disabled	Disables the onboard Serial Port.
	Enabled	Enables and allows you to manually configure the I/O address and Interrupt Request (IRQ) line for the Serial Port.
	Auto*	Enables and automatically configures the Serial Port.
Infrared Port	Disabled*	Disables the onboard Infrared Port.
	Enabled	Enables and allows you to manually configure the operating mode, I/O address and Interrupt Request (IRQ) line, and DMA channel for the Infrared Port.
	Auto	Enables and automatically configures the Infrared Port. You must manually configure the operating mode.
Parallel Port	Disabled	Disables the onboard Parallel Port.
	Enabled	Enables and allows you to manually configure I/O address, Interrupt Request (IRQ) line and DMA channel (if ECP is selected for Parallel Port Mode) for the Infrared Port.
	Auto*	Enables and automatically configures the Parallel Port.
Parallel Port Mode	Output only	Select the mode supported by the printer. See the printer's User Guide for details.
	Bi-directional*	
	ECP (Extended Capabilities Port)	
	EPP (Enhanced Parallel Port)	

\*Factory default setting

**NOTE:** It is highly recommended that you use the Auto configure setting. If you need to manually configure a device, it is recommended that you use the “System” application located in the Windows “Control Panel.”

## 2.5 Security Menu

Feature	Settings	Comments
Supervisor Password Is	Display only field.	When set to Clear, a Supervisor Password has not been set.
User Password Is	Display only field.	When set to Clear, a User Password has not been set.
Set Supervisor Password	Enter a password of up to eight alphanumeric characters. Password is not case sensitive.	This option allows you to set a Supervisor Password that will be required to enter the System Setup. This password can be used in place of the User Password. <b>IMPORTANT:</b> Be sure to write the password down and store it in a safe place.
Set User Password	Enter a password of up to eight alphanumeric characters. Password is not case sensitive.	This option allows you to set a User Password that will be required during: System Setup access and System Boot, Resume, and Undock operations if enabled. <b>IMPORTANT:</b> Be sure to write the password down and store it in a safe place.
Password on Boot	Disabled* Enabled	When set to Enabled, you will be prompted for a password on each system boot. A User Password must be set in order to access this feature.
Password on Resume	Disabled* Enabled	When set to Enabled, you will be prompted for a password each time the system resumes operation from Suspend Mode. A User Password must be set in order to access this feature.
Password on Undock	Disabled* Enabled	This option allows you to enable a password to prevent unauthorized undocking of the computer from the Armada 6500 Convenience Base or Mobile 6500 Expansion Unit. When a User Password is set and this option is set to Enabled, the computer cannot be undocked unless the system is powered on and the User or Supervisor Password is supplied.

\*Factory default setting

.....

## Security

The computer provides the following levels of protection:

- User Password – Used to prevent unauthorized access to the computer and prevent unauthorized removal of the computer from a docking option. The User Password also allows access to a subset of the System Setup options.
- Supervisor Password – Used to prevent unauthorized access to the computer's System Setup.
- Password on Undock – Used to prevent unauthorized undocking of the computer from the Armada 6500 Convenience Base or Mobile 6500 Expansion Unit. Requires a User Password be set.

### Setting/Changing a Supervisor Password

If you set a Supervisor Password, you need to enter it each time you want to access the System Setup. Perform the following steps to set or change the Supervisor Password:

**NOTE:** The Supervisor Password can be used in place of the User Password.

1. Turn on the computer.
2. During system boot, press **Fn + F3** when the Compaq logo appears to enter System Setup.
3. If a Supervisor Password is set, enter the Supervisor Password when prompted.

The System Setup main menu will appear on the screen.

4. Highlight the Security menu option.
5. Highlight the Set Supervisor Password field and press **Enter**.
6. Type in the password and press **Enter**. The password can be up to eight alphanumeric characters and is not case sensitive. Symbols and other keys are ignored.

To confirm, type in the Supervisor Password a second time and press **Enter**.

**NOTE:** If a password already exists, you will be prompted to enter the old password before a new one can be set.



- .....
7. When the Notice dialog box appears notifying you that changes have been saved, press **Enter**.
  8. Select the Exit menu and choose Exit Saving Changes to save the new settings and exit System Setup.

When you access System Setup, you will be prompted for the Supervisor Password.

**NOTE:** Passwords take effect immediately upon confirmation. The password will remain in effect if you exit the System Setup Program without saving the new configuration settings.

### **Setting/Changing a User Password**

The User Password prevents unauthorized access to the computer and unauthorized removal of the computer from a docking option. It also allows access to a subset of the System Setup option. Perform the following steps to set or change the User Password:

1. Turn on the computer.
2. During system boot, press **Fn + F3** when the Compaq logo appears to enter System Setup.
3. If a User Password is set, enter the User Password when prompted.
4. Highlight the Security menu.
5. Highlight the Set User Password field and press **Enter**.
6. Type in the password and press **Enter**. The password can be up to eight alphanumeric characters and is not case sensitive. Symbols and other keys are ignored.

To confirm, type in the User Password a second time and press **Enter**.

**NOTE:** If a password already exists, you will be prompted to enter the *old password* before a new one can be set.

7. When the Notice dialog box appears notifying you that changes have been saved, press **Enter**.
8. Select the Exit menu and choose Exit Saving Changes to save the new settings and exit System Setup.

**NOTE:** Passwords take effect immediately upon confirmation. The password will remain in effect if you exit the System Setup Program without saving the new configuration settings.

.....

## **Deleting a Supervisor or User Password**

To delete a Supervisor or User Password:

1. Turn on the computer.
2. During system boot, press **Fn + F3** when the Compaq logo appears to enter System Setup.
3. When prompted, enter the password to be deleted.
4. Highlight the Security menu.
5. If deleting the Supervisor Password, highlight the Set Supervisor Password field and press **Enter**. If deleting the User Password, highlight the Set User Password field and press **Enter**.
6. When prompted enter the old password.
7. With the cursor in the “Enter new password” field, press **Enter**.
8. The cursor will move to the “Re-enter new password” field. Press **Enter**.
9. When the Notice dialog box appears notifying you that changes have been saved, press **Enter**.
10. Select the Exit menu and choose Exit Saving Changes to save the new settings and exit System Setup.

## **Password on Undock**

Setting a User Password and enabling Password on Undock prevents unauthorized undocking of the computer from the Compaq Mobile 6500 Expansion Unit and/or the Compaq Armada 6500 Convenience Base. When a request is made to undock the computer, you will be prompted for a password. Enter either the Supervisor or User Password to complete the undock request and undock the computer.

## 2.6 Power Menu

The computer is factory-configured with preset power management values. If you are not an advanced user, start by using the default (factory-configured) power management settings. If you find that the factory settings do not fit your specific needs, enter the System Setup Program and make the needed changes.

Feature	Settings	Comments
Power Savings	Disabled	Disables all power management features.
	Customized*	Allows you to customize the power management features.
	Maximum Power Savings	Use Maximum Power Savings when you want to maximize the time between battery charges.
	Maximum Performance	Use Maximum Performance when you want to maximize the performance of the computer while retaining some power savings for extending the life of the battery.
Standby Timeout	Off	This option allows you to specify a period of time the system must be inactive before the system is placed in Standby mode.  Standby mode shuts down power to the LCD and backlight, hard drive, diskette drive, and external devices.  <b>NOTE:</b> The selected period for inactivity is measured from the last monitored system activity. A keystroke, mouse movement, or hard disk activity, for example, will reset the timer.
	Selected times	
Auto Suspend Timeout	Off	This option allows you to specify a period of time the system is in Standby before entering Suspend.  Suspend is similar to Standby except all devices are powered down (with the exception of system memory, if Suspend Mode is set to Suspend to RAM). To resume operation, press the Suspend/Power button.
	Selected times	
Suspend Mode	Suspend to RAM*	This option allows you select the type of Suspend Mode the system will enter when the Auto Suspend Timeout timer expires. If you choose Save to Disk, the system will save all application settings, data and memory to the hard drive, then completely power off the system. If you choose Suspend to RAM, the system will save all application settings and data to system memory, then power off all other devices (except system memory).
	Save to Disk	
Hard Disk Timeout	Disabled Selected times	This option allows you to specify a period of time the hard disk drive must be inactive before it spins down.
Video Timeout	Disabled Selected times	This option allows you to specify a period of time the system must be inactive before the LCD backlight is turned off.
Cooling Mode	Passive → Active* Active → Passive	This option determines the order in which the cooling systems are triggered as the system temperature increases. Passive → Active throttles down the CPU first, then turns on the cooling fan. Active → Passive turns on the cooling fan first, then throttles down the CPU.

*continued*

.....

### Power Menu (continued)

Feature	Settings	Comments
Resume On Time	Off* On	When this option is set to On and Suspend Mode is set to Suspend to RAM, the system wakes up at the time defined in Resume Time. <b>Resume on Time will not work when the Suspend Mode is set to Save to Disk.</b>
Resume Time	Enter resume time: hour, minute, second format.	This option sets the time that the system will wake up from Suspend. Resume On Time must be set to On in order for the system to wake at the defined time.
Resume Date	Enter resume date: month, day, year format.	This option sets the date that the system will wake up from Suspend. Resume On Time must be set to On in order for the system to wake on the defined date.

\*Factory default setting

## 2.7 Boot Menu

Enter the Boot Menu to change the order in which devices will be searched for an operating system.

Feature	Settings	Comments
Summary Screen	Disabled* Enabled	This option allows you to view a system configuration screen during bootup.
QuickBoot Mode	Disabled Enabled*	When set to Enabled, this option reduces the time required to complete POST by allowing the system to test only the major system components.
Boot Device Priority	Submenu	This option allows you to define the drive boot sequence. To change the order, move the highlighted cell to the field to be moved. Press <b>F5</b> to move the field to a lower priority. Press <b>F6</b> to move the field to a higher priority.  Default priority: 1. [diskette drive] 2. [removable devices] 3. [hard drive] 4. [ATAPI CD-ROM drive] (or DVD-ROM drive)

\*Factory default setting

---

## 2.8 Exit Menu

Enter the Exit Menu to save changes, set factory defaults or exit the System Setup Program.

Feature	Action	Comments
Exit Saving Changes	Press <b>Enter</b> .	Exit System Setup and save your changes to CMOS.
Exit Discarding Changes	Press <b>Enter</b> .	Exit System Setup without saving data to CMOS.
Load Setup Defaults	Press <b>Enter</b> .	Load default values for all System Setup items.
Discard Changes	Press <b>Enter</b> .	Load previous values from CMOS for all Setup items.
Save Custom Defaults	Press <b>Enter</b> .	Save current settings as custom defaults.
Load Custom Defaults	Press <b>Enter</b> .	Load previously saved values to CMOS.
Save Changes	Press <b>Enter</b> .	Save Setup data to CMOS, but not exit.

## 2.9 Restoring the Flash BIOS

To restore a corrupted Flash BIOS a Crisis Recovery diskette is required.

To restore the Flash BIOS:

1. Turn the computer off by pressing **Fn + Standby/Resume** button.
2. Make sure the diskette drive is installed in the computer MultiBay.
3. Enable Crisis Recovery mode by placing a jumper across resistor R744. This resistor is located in the expansion memory compartment on the bottom of the unit. To locate the resistor:
  - a) Place the unit in front of you with the bottom up and the battery closest to you.
  - b) Remove the cover on the memory compartment.
  - c) The resistor is located in the lower left corner of the memory compartment.
4. Place the Crisis Recovery disk in the drive.
5. Turn On the system. When the BIOS is restored, turn off the system by pressing **Fn + Suspend/Power** button.

Remove the jumper across resistor R744.

# Troubleshooting

This chapter provides a systematic method of isolating problems with the Compaq Armada 6500 notebook computer. A basic understanding of DOS-based computer systems as well as a knowledge of standard troubleshooting procedures is assumed. This manual is written under the assumption the problems are related to the computer. Improper use of the system and application software problems are excluded in this chapter.

The system BIOS power on self-tests (POST) are integral to the system and detect certain errors with the system board. They use a series of beep codes to identify certain system board problems.

The troubleshooting procedures, when followed step by step, can help isolate system problems.

## 3.1 Troubleshooting Tips

In general, troubleshooting involves an organized system of approach to problem solving. Try to isolate the problem and identify the defective device (hardware) or improper setting (software). When a problem is encountered, perform a thorough visual inspection of the computer.

- If none of the indicators are lit and the hard drive cannot be heard spinning, the computer is probably not receiving power.
- Make sure the power cord is plugged in, and the AC adapter is securely connected. The LEDs on the AC adapter and the system should be on when connected to a working AC source.
- If a power strip or surge protector is being used, make sure these devices are turned on.
- When powering the system by battery, make sure the battery is charged.

Often problems are caused by improperly connected cables.

- If a mouse or keyboard is being used, make sure they are properly connected to their respective ports. Make sure none of the connector pins are bent or broken.
- Check all cables connected to the computer. If any are cut, frayed, or damaged in any way, replace them right away. Never use a damaged cable. A damaged cable is not only a fire hazard, it may also cause a short circuit, resulting in irreparable damage to the computer.
- Check all internal connections to ensure they are secure. Problems often occur because a connection is loose or backwards.

.....

Verify all test equipment works before using it to test a malfunctioning component.

Verify a component is the only malfunctioning part of the computer by replacing the malfunctioning component with a properly functioning one, and then try to run the system. For example, if a diskette drive has been tested in a test computer and has been found to be bad, test a working diskette drive in the malfunctioning diskette drive's computer to be sure another component (such as the diskette drive controller) is not bad as well.

As with assembly and disassembly, make sure to have adequate lighting, the right tools, and a stable clean working environment.

The following examples provide useful tips and information that will help isolate and solve some of the more common problems that may be encountered.

## **System Start Failure**

When the computer is turned on, the system hangs before completing or starting the POST (power on self-test). A power supply failure, POST failure, or boot-up failure can result in a system start failure. Reset the system by pressing the reset button located on the rear of the computer next to the PS/2 connector (Figure 1-3) and restart the system.

---

## Power Supply Failure

Problem	Troubleshooting Procedure
<p>The computer is turned on using the power switch and the following conditions apply:</p> <ul style="list-style-type: none"><li>• There is no panel display</li><li>• There is no noise coming from the HARD DRIVE</li><li>• The power indicator light is off (AC operation).</li></ul>	<p>If the computer is running on the battery:</p> <ul style="list-style-type: none"><li>• The system could be in suspend. Press the Suspend/Power button.</li><li>• The battery connection is loose. Remove and reinstall the battery.</li><li>• The battery power is depleted. Plug in the AC adapter, or replace the battery.</li><li>• The system could be experiencing a hang. Press the reset button located on the rear of the computer next to the PS/2 connector.</li></ul> <p>If the computer is running on the AC adapter:</p> <ul style="list-style-type: none"><li>• Make sure the AC adapter is plugged into an operational power supply.</li><li>• Make sure the AC adapter is connected securely to the computer's AC adapter socket.</li><li>• Check to see if the Power LED on the computer is lit. If not lit, then the AC adapter may be bad. Replace the AC adapter, and test the computer again.</li><li>• Press the Suspend/Power button.</li><li>• Press the reset button located on the rear of the computer next to the PS/2 connector (Figure 1-3).</li></ul> <p>If the above items do not solve the problem, replace the DC-to-DC Converter.</p>



---

## Boot-up Failure

<b>Problem</b>	<b>Troubleshooting Procedure</b>
<p>The computer is turned on and the following conditions apply:</p> <ul style="list-style-type: none"><li>• The computer's power is on. (green power LED is lit.)</li><li>• There is no screen display.</li></ul>	<ul style="list-style-type: none"><li>• System in Suspend Mode. Press the Suspend/Power button.</li><li>• System possibly hung after using a screen saver. Press the Reset button located on the rear of the computer next to the PS/2 connector (Figure1-3).</li><li>• Check the DRAM connections to be sure they are secure.</li><li>• Check the LCD connections.</li><li>• Check the system board power circuit.</li></ul>

## POST Failure

<b>Problem</b>	<b>Troubleshooting Procedure</b>
<p>The computer is turned on and the following happens:</p> <ul style="list-style-type: none"><li>• There is power to the system and the hard drive seems to be spinning.</li><li>• The computer emits a series of beeps.</li></ul>	<ul style="list-style-type: none"><li>• A POST failure usually indicates a memory, BIOS, or hard drive failure. Refer to the table at the end of this chapter for a list of Beep Codes.</li></ul>

## Cardbus Failure

<b>Problem</b>	<b>Troubleshooting Procedure</b>
<p>The Cardbus slots do not work.</p>	<ul style="list-style-type: none"><li>• Reseat the Cardbus assembly cable.</li><li>• Replace the Cardbus Assembly.</li><li>• Replace the Motherboard.</li></ul>

---

## LCD Panel Failure

Problem	Troubleshooting Procedure
<p>The computer is turned on and one of the following conditions apply:</p> <ul style="list-style-type: none"><li>• The system is working, but there is no LCD panel display.</li><li>• The system is working, but the LCD panel displays vertical or horizontal lines.</li><li>• The backlight comes on, but there is no display.</li><li>• There is a display, but there are unwanted lines on the screen.</li></ul>	<ul style="list-style-type: none"><li>• If using the AC Adapter, make sure the green power indicator is on.</li><li>• Verify video operation by connecting an external monitor to the system. Press <b>Fn + F4</b> to enable the external VGA port.</li><li>• Make sure the LCD cables are properly seated and securely connected to the Motherboard and LCD Interface board.</li><li>• Make sure the LCD cable is securely connected to the inverter. The INV/MIC/Status LCD cable may be bad. Change the INV/MIC/Status LCD cable.</li><li>• Replace the DC/AC inverter board.</li><li>• Replace the LCD Interface board.</li><li>• Replace the Motherboard. Possible bad VGA chip.</li><li>• Replace the LCD panel.</li></ul>

## CRT Failure

Problem	Troubleshooting Procedure
<p>The computer has power, the computer's LCD panel is working and one of the following conditions apply:</p> <ul style="list-style-type: none"><li>• The computer's LCD panel is working.</li><li>• There is no display on the CRT.</li><li>• The color of the CRT display is wrong.</li><li>• There is a display, but the display is not stable.</li></ul>	<ul style="list-style-type: none"><li>• Make sure the CRT output is enabled. Press <b>Fn + F4</b> to enable/disable the external video port.</li><li>• Make sure the CRT's power is on and the power cables are securely connected.</li><li>• Make sure the CRT to computer cable connection is secure. Check the CRT port on the computer to make sure the connection is secure, and there are no damaged pins or connectors.</li><li>• Make sure the settings in the operating system's Control Panel Display icon are supported by the monitor.</li><li>• If the CRT still does not work, change to a different CRT and try again.</li><li>• If the color is bad, adjust the monitor's color controls (if any).</li></ul>

---

## Computer Keyboard Failure

<b>Problem</b>	<b>Troubleshooting Procedure</b>
<p>The computer is powered-on. However, when pressing any of the keys on the keyboard, one of the following events occurs:</p> <ul style="list-style-type: none"><li>• Pressing on the key does not have any effect.</li><li>• Incorrect characters are displayed on the screen.</li><li>• One stroke of a key produces too many characters on the screen.</li></ul>	<ul style="list-style-type: none"><li>• Make sure the keyboard cables are securely connected.</li><li>• Replace the keyboard and check again.</li><li>• Press the Reset button located on the rear of the computer next to the PS/2 connector (Figure 1-3).</li><li>• Make sure the correct language variant of the keyboard is being used.</li><li>• Replace the system board.</li></ul>

## External Keyboard or PS/2 Mouse Failure

<b>Problem</b>	<b>Troubleshooting Procedure</b>
<p>The computer's power is on, and the keyboard is working. One of the following conditions occur:</p> <ul style="list-style-type: none"><li>• Pressing keys on the external keyboard has no effect.</li><li>• Pressing keys on the external keyboard gives incorrect characters.</li><li>• The mouse cursor on the screen does not move in conjunction with the external mouse.</li></ul>	<ul style="list-style-type: none"><li>• Make sure the external mouse or keyboard's connection to the computer's PS/2 mini-DIN connector is secure.</li><li>• Make sure the mouse trackball and position sensors are clean and free of dust.</li><li>• Replace the external mouse or keyboard and try again.</li><li>• If the system still does not work, reseal the PS2/Reset/IR cable on the Motherboard.</li></ul>

## Hard Drive Failure

<b>Problem</b>	<b>Troubleshooting Procedure</b>
<p>When an attempt is made to to access the hard drive, one of the following conditions occur:</p> <ul style="list-style-type: none"><li>• There is a message indicating the hard drive does not exist.</li><li>• The hard drive cannot be read from.</li><li>• The hard drive cannot be written to.</li></ul>	<ul style="list-style-type: none"><li>• Make sure the hard drive connection is secure.</li><li>• Try a working hard drive.</li><li>• Install the hard drive into another Armada 6500 computer to test it.</li><li>• If the hard drive works in a test computer, the hard drive controller on the Motherboard is probably bad. Test the Motherboard.</li></ul>

---

## Diskette Drive Failure

<b>Problem</b>	<b>Troubleshooting Procedure</b>
<p>The computer's power is on. The hard drive is functioning correctly. When an attempt is made to access the diskette drive, one of the following conditions occurs:</p> <ul style="list-style-type: none"><li>• The diskette drive cannot be read from.</li><li>• The diskette drive cannot be written to.</li><li>• The diskette drive motor cannot be heard spinning, and the LED indicator light is not on.</li></ul>	<ul style="list-style-type: none"><li>• Check the BIOS settings for the diskette drive. Refer to Chapter 2.</li><li>• Make sure the CD-ROM/diskette drive module is properly seated.</li><li>• Make sure only one diskette drive is installed in a system with a Mobile 6500 Expansion Unit attached. The system supports only one diskette drive.</li><li>• Try a different diskette in the drive. Make sure the diskette is not write protected.</li><li>• Clean the diskette drive's heads.</li><li>• Change the diskette drive module and test again.</li><li>• If the drive still does not work, replace the main board.</li></ul>

## CD-ROM Failure

<b>Problem</b>	<b>Troubleshooting Procedure</b>
<p>The computer's power is on. The hard drive is functioning correctly. When an attempt is made to access the CD-ROM drive, one of the following conditions occurs:</p> <ul style="list-style-type: none"><li>• The CD-ROM drive cannot be read from.</li><li>• The CD-ROM drive motor cannot be heard spinning, and the LED indicator light is not on.</li></ul>	<ul style="list-style-type: none"><li>• Check the BIOS settings for the CD-ROM drive. Refer to Chapter 2.</li><li>• Make sure the CD-ROM drive is properly seated.</li><li>• Make sure only one CD-ROM drive is installed in a system with a Mobile 6500 Expansion Unit attached.</li><li>• Switch to a different CD-ROM drive and try again.</li><li>• Clean the CD-ROM's lens.</li><li>• Change the CD-ROM drive and test again.</li><li>• If the CD-ROM drive still does not work, replace the Motherboard.</li></ul>

---

## Battery Failure

Problem	Troubleshooting Procedure
The computer's AC power works. When trying to use battery power, the computer does not operate. However, when the AC Adapter is connected, the battery charge indicator flashes.	<ul style="list-style-type: none"><li>• Make sure the battery contacts are in good condition.</li><li>• Make sure the battery terminals are clean. If necessary, clean the terminals with contact cleaner.</li><li>• Change the battery and try again.</li><li>• Make sure the AC power supply (the AC adapter and AC adapter cord) are working. If they are not supplying the correct voltage, it could damage the system.</li></ul>

## Touchpad Failure

Problem	Troubleshooting Procedure
The touchpad does not work.	<ul style="list-style-type: none"><li>• Check the touchpad settings in the operating system's control panel.</li><li>• Make sure the UMI cable connection to the Motherboard is properly seated. This connector is located under the keyboard deck behind the touchpad. <b>NOTE:</b> If both the touchpad and modem/network do not work, this cable is most likely not connected.</li><li>• Make sure the UMI cable is properly connected to the Touchpad connector.</li></ul>

## Internal Modem/Network (UMI) Failure

Problem	Troubleshooting Procedure
The internal modem/network (if installed) does not work.	<ul style="list-style-type: none"><li>• Make sure the Modem/Ethernet Combo Card, UMI adapter are properly seated.</li><li>• Make sure the modem/network software is properly configured.</li><li>• Verify the modem/network port is enabled. This is done using the System icon in the Control Panel of the operating system.</li><li>• Make sure the UMI cable is properly connected to the Motherboard. This connector is located under the Keyboard Deck behind the Touchpad. <b>NOTE:</b> If both the Touchpad and modem/network do not work, this cable is most likely not connected.</li></ul>

---

## External Audio Failure

Problem	Troubleshooting Procedure
No sound from external speakers connected to external audio port.	<ul style="list-style-type: none"><li>• Make sure the connections are properly seated.</li><li>• Make sure power is applied to the speakers (if necessary).</li><li>• Replace the DC/DC Converter board.</li></ul>

## 3.2 Check Points and Error Messages

At the beginning of each POST routine, the BIOS outputs the test point error code to I/O address 80h. Use this code during troubleshooting to establish at what point the system failed and what routine was being performed.

If the BIOS detects a terminal error condition, it halts POST after:

- Issuing a terminal error beep code and
- Attempting to display the error code on upper left corner of the screen and on the port 80h LED display

If the system hangs before the BIOS can process the error, the code displayed at port 80h is that of the last test performed. In this case, the screen does not display the error code.

## Phoenix BIOS Test Points

The following is a list of the checkpoint codes written at the start of each test and the beep codes issued for terminal errors:

Code	Beeps	POST Routine Description
02h		Verify Real Mode.
03h		Disable Non-Maskable Interrupt (NMI).
04h		Get CPU type.
06h		Initialize system hardware.
08h		Initialize chipset with Initial POST Values.
09h		Set IN POST flag.
0Ah		Initialize CPU registers
0Bh		Enable CPU cache.
0Ch		Initialize caches to initial POST values.
0Eh		Initialize I/O component.
0Fh		Enable the local bus IDE.

*continued*

.....

**Phoenix BIOS Test Point Beep Codes** *(continued)*

<b>Code</b>	<b>Beeps</b>	<b>POST Routine Description</b>
10h		Initialize Power Management.
11h		Load alternate registers with initial POST values.
12h		Restore CPU control word during warm boot.
13h		Initialize PCI Bus Mastering devices.
14h		Initialize keyboard controller.
16h	1-2-2-3	BIOS ROM checksum.
17h		Initialize cache before memory autosize.
18h		8254 timer initialization.
1Ah		8237 DMA controller initialization.
1Ch		Reset Programmable Interrupt Controller.
20h	1-3-1-1	Test DRAM refresh.
22h	1-3-1-3	Test 8742 Keyboard Controller.
24h		Set ES segment register to 4 GB
26h		Enable A20 line.
28h		Autosize DRAM.
29h		Initialize POST Memory Manager.
2Ah		Clear 512KB base RAM.
2Ch	1-3-4-1	RAM failure on address line XXXX*.
2Eh	1-3-4-3	RAM failure on data bits XXXX* of low byte of memory bus.
2Fh		Enable cache before system BIOS shadow.
30h	1-4-1-1	RAM failure on data bits XXXX* of high byte of memory bus.
32h		Test CPU bus-clock frequency.
33h		Initialize Phoenix Dispatch Manager.
36h		Warm start shut down.
38h		Shadow system BIOS ROM.
3Ah		Autosize cache.
3Ch		Advanced configuration of chipset registers.
3Dh		Load alternate registers with CMOS values.
42h		Initialize interrupt vectors.
45h		POST device initialization.

*continued*

Phoenix BIOS Test Point Beep Codes *(continued)*

<b>Code</b>	<b>Beeps</b>	<b>POST Routine Description</b>
46h	2-1-2-3	Check ROM copyright notice.
48h		Check video configuration against CMOS.
49h		Initialize PCI bus and devices.
4Ah		Initialize all video adapters in system.
4Bh		QuietBoot start (optional).
4Ch		Shadow video BIOS ROM.
4Eh		Display copyright notice.
50h		Display CPU type and speed.
51h		Initialize EISA board.
52h		Test keyboard.
54h		Set key click if enabled.
58h	2-2-3-1	Test for unexpected interrupts.
59h		Initialize POST display service.
5Ah		Display prompt "Press F2 to enter SETUP".
5Bh		Disable CPU cache.
5Ch		Test RAM between 512K and 640K.
60h		Test extended memory.
62h		Test extended memory address lines.
64h		Jump to UserPatch1.
66h		Configure advanced cache registers.
67h		Initialize Multi Processor APIC
68h		Enable external and CPU caches.
69h		Setup System Management Mode (SMM) area.
6Ah		Display external L2 cache size.
6Bh		Load custom defaults (optional).
6Ch		Display shadow-area message.
6Eh		Display possible high address for UMB recovery.
70h		Display error messages.
72h		Check for configuration errors.
76h		Check for keyboard errors.

*continued*



.....

**Phoenix BIOS Test Point Beep Codes** *(continued)*

<b>Code</b>	<b>Beeps</b>	<b>POST Routine Description</b>
7Ch		Set up hardware interrupt vectors.
7Eh		Initialize coprocessor if present.
80h		Disable onboard Super I/O ports and IRQs.
81h		Late POST device initialization.
82h		Detect and install external RS232 ports.
83h		Configure non-MCD IDE controllers.
84h		Detect and install external parallel ports.
85h		Initialize PC-compatible PnP ISA devices.
86h		Re-initialize onboard I/O ports.
87h		Configure Motherboard Configurable Devices (optional).
88h		Initialize BIOS Data Area.
89h		Enable Non-Maskable Interrupts (NMIs).
8Ah		Initialize Extended BIOS Data Area.
8Bh		Test and initialize PS/2 mouse.
8Ch		Initialize diskette drive controller.
8Fh		Determine number of ATA drives (optional).
90h		Initialize hard-disk controllers.
91h		Initialize local-bus hard-disk controllers.
92h		Jump to UserPatch2.
93h		Build MPTABLE for multi-processor boards.
95h		Install CD ROM for boot.
96h		Clear huge ES segment register.
97h		Fixup Multi Processor table.
98h	1-2	Search for option ROMs. One long, two short beeps on checksum failure.
99h		Check for SMART Drive (optional).
9Ah		Shadow option ROMs.
9Ch		Set up Power Management.
9Dh		Initialize Security Engine (optional).
9Eh		Enable hardware interrupts.
9Fh		Determine number of ATA and SCSI drives.

*continued*

Phoenix BIOS Test Point Beep Codes *(continued)*

Code	Beeps	POST Routine Description
A0h		Set time of day.
A2h		Check key lock.
A4h		Initialize typematic rate.
A8h		Erase F2 prompt.
AAh		Scan for F2 key stroke.
ACh		Enter SETUP.
A Eh		Clear Boot flag..
B0h		Check for errors.
B2h		POST done - prepare to boot operating system.
B4h	1	One short beep before boot.
B5h		Terminate QuickBoot (optional).
B6h		Check password (optional).
B9h		Prepare Boot.
BAh		Initialize DMI parameters.
BBh		Initialize PnP Option ROMs.
BCh		Clear parity checkers.
BDh		Display Multi-Boot menu.
BEh		Clear screen (optional).
BFh		Check virus and backup reminders.
C0h		Try to boot with INT 19.
C1h		Initialize the Post Error Manager (PEM).
C2h		Initialize error logging.
C3h		Initialize error display function.
C4h		Initialize system error handler.
C5h		PnP dual CMOS (optional).
C6h		Initialize computer docking (optional).
C7h		Initialize computer docking late.
C8h		Force check (optional).
C9h		Extended Checksum (optional).
D2h		Unknown interrupt

\* If the BIOS detects error 2C, 2E, or 30 (base 512K RAM error), it displays an additional word-bitmap (XXXX) indicating the address line or bits that failed. For example, "2C 0002" means data bits 12 and 5 (bits 12 and 5 set) have failed in the lower 16 bits. The BIOS also sends the bitmap to the port-80 LED display. It first displays the check point code, followed by a delay, the high-order byte, another delay, and then the low-order byte of the error. It repeats this sequence continuously.

---

## Warning Messages

The following is an alphabetic list of error and status messages which the Phoenix BIOS can generate and an explanation of each message. Many of the messages below refer to the built-in Setup program.

Message	Description
nnnn Cache SRAM Passed	nnnn is the amount of system cache in kilobytes successfully tested.
Diskette drive A error	Drive A: is present but fails the BIOS POST diskette tests. Make sure the drive is defined with the proper diskette type in Setup and the diskette drive is attached properly.
Entering SETUP	Starting Setup program.
Extended RAM Failed at offset: nnnn	Extended memory not working or not configured properly.
nnnn Extended RAM Passed	nnnn is the amount of RAM in kilobytes successfully tested.
Failing Bits: nnnn	The hex number nnnn is a map of the bits at the RAM address (in System, Extended, or Shadow memory) which failed the memory test. Each 1 (one) in the map indicates a failed bit.
Fixed Disk 0 Failure or Fixed Disk 1 Failure or Fixed Disk Controller Failure	Fixed disk is not working or not configured properly. Check to see if fixed disk is attached properly. Run Setup to ensure the fixed disk type is correctly identified.
Incorrect Drive A type run SETUP	Type of diskette drive A: not correctly identified in SETUP.
Invalid NVRAM media type	Problem with NVRAM access.
Keyboard controller error	The keyboard controller failed test. Replace keyboard or controller.
Keyboard error	Keyboard not working.
Keyboard error nn	BIOS discovered a stuck key and displays the scan code for the stuck key.
Keyboard locked Unlock key switch	Unlock the system to proceed.
Monitor type does not match CMOS	Run SETUP Monitor type not correctly identified in Setup.

*continued*

.....

### Warning Messages *(continued)*

Message	Description
Operating System not found	Operating system cannot be located on either drive A: or drive C:. Enter Setup and see if fixed disk and drive A: are properly identified.
Parity Check 1 nnnn Parity error found in the system bus	BIOS attempts to locate the address but failed and displays it on the screen.
Parity Check 2 nnnn Parity error found in the I/O bus	BIOS attempts to locate the address but failed and displays it on the screen.
Press <F1> to resume, <F2> to Setup	Display after any recoverable error message: Press <F1> to start the boot process or <F2> to enter Setup and change any settings. <F2> Press <F2> to enter Setup Optional message displayed during POST.
Previous boot incomplete.	Default configuration used.
Previous POST did not complete successfully	POST loads default values and offers to run Setup. If the failure was caused by incorrect values and they are not corrected, the next boot will likely fail.
Real time clock error	Real time clock fails BIOS test. May require board repair.
Shadow RAM Failed at offset: nnnn	Shadow RAM failed at offset nnnn of the 64k block at which the error was detected.
nnnn Shadow RAM Passed	Where nnnn is the amount of shadow RAM in kilobytes successfully tested.
System battery is dead - Replace and run SETUP	The CMOS clock battery indicator shows the battery is dead. Replace the battery and run Setup to reconfigure the system.
System cache error	Cache disable RAM cache failed the BIOS test. BIOS disabled the cache.
System CMOS checksum bad - run SETUP	System CMOS has been corrupted or modified incorrectly, perhaps by an application program that changes data stored in CMOS. Run Setup and reconfigure the system.
System RAM Failed at offset: nnnn	System RAM failed at offset nnnn of the 64k block at which the error was detected.
nnnn System RAM Passed	nnnn is the amount of system RAM in kilobytes successfully tested.
System timer error	The timer test failed. Requires repair of system board.
UMB upper limit segment address: nnnn	Displays the address of the upper limit of Upper Memory Blocks, indicating released segments of the BIOS which may be reclaimed by a virtual memory manager.
Video BIOS shadowed	Video BIOS successfully copied to shadow RAM.

# FRU Replacement

## 4.1 Introduction

This chapter provides detailed procedures for replacing the Compaq Armada 6500 notebook computer Field Replaceable Units (FRUs). Unless otherwise noted the replacement procedures for the FRUs are the reverse of the removal procedures.



**WARNING:** Static electricity collects on non-conductors such as paper, cloth, or plastic. A static discharge can be damaging even though it is not seen or felt. To prevent damage to circuit boards and/or components:

- Before touching any circuit board or component, touch the metal frame of the workstation to discharge any static electricity
- Keep circuit boards and components away from non-conductors.

## 4.2 Required Tools

The following tools are required to remove and replace the computer FRUs:

- #0 and #1 Phillips-head Screwdrivers
- 3/16 inch Nut Driver
- Tweezers

## 4.3 Service Options

This section contains a list of service options with part numbers available for the computer.

<b>Display Assembly</b>				
<i>Item</i>	<i>Compaq Spare Part Number</i>	<i>DEC FRU Part Number</i>	<i>Vendor</i>	<i>Description</i>
1	358948-001	22-15176-01	6305B00037A	SPS-Panel display 14.1-inch, LG/XGA display assembly Left & right hinge covers Front & rear hinge screws (4 each)

---

---

### *Li-Ion Battery*

---

<i>Item</i>	<i>Compaq Spare Part Number</i>	<i>DEC FRU Part Number</i>	<i>Vendor</i>	<i>Description</i>
2	358977-001	30-50400-01	6911B00004D	Li-Ion Battery, Sony 12 cell

---

### *Optional Drives*

---

<i>Item</i>	<i>Compaq Spare Part Number</i>	<i>DEC FRU Part Number</i>	<i>Vendor</i>	<i>Description</i>
3	358949-001	30-50370-01	3111BZ9008C	Diskette drive
4	358956-001	30-50372-02	4981BZ9001B	CD ROM drive, 24X
*	358989-001	30-50458-01	2185B00240A	DVD Bay/Dock, Toshiba
*	359007-001	30-50459-01	2185B00243A	LS120 Bay/Dock
*	358946-001	30-50460-01	2185B00242A	Zip Drive, lomega

---

\* not illustrated

---

---

### *Keyboards*

---

<i>Item</i>	<i>Compaq Spare Part Number</i>	<i>DEC FRU Part Number</i>	<i>Vendor</i>	<i>Description</i>
5	358937-001	30-50378-01	3823B30030B	Keyboard, US/American
	358937-031	30-50379-01	3823B30031B	Keyboard, UK/British
	358937-292	30-50380-01	3823B30035B	Keyboard, Japanese
	358937-051	30-50381-01	3823B30032B	Keyboard, French
	358937-041	30-50382-01	3823B30033B	Keyboard, German
	358937-061	30-50383-01	3823B30036B	Keyboard, Italian
	358937-071	30-50384-01	3823B30034B	Keyboard, Spanish
	358937-101	30-50385-01	3823B30037B	Keyboard, Swed/Finn (Suomi)
	358937-111	30-50386-01	3823B30038B	Keyboard, Swiss
	358937-081	30-50387-01	3823B30040B	Keyboard, Danish
	358937-091	30-50388-01	3823B30041B	Keyboard, Norwegian
	358937-121	30-50389-01	3823B30039B	Keyboard, FR/Canadian
	358937-131	30-50394-01	3823B30042B	Keyboard, Portuguese
	358937-181	30-50395-01	3823B30042B	Keyboard, Belgian

---

---



---

<b>Memory</b>		
<i>Item</i>	<i>Compaq Spare Part Number</i>	<i>Description</i>
6	313911-001	32-MB Memory Module, SODIMM
	313918-001	64-MB Memory Module, SODIMM
	310345-001	128-MB Memory Module, SODIMM

---

<b>Hard Drives</b>				
<i>Item</i>	<i>Compaq Spare Part Number</i>	<i>DEC FRU Part Number</i>	<i>Vendor</i>	<i>Description</i>
7	358957-001	30-50398-01		6-GB removable hard drive
	358958-001	30-50399-01	2185B00244A	6-GB MultiBay hard drive

---

<b>CPU Base Enclosure with System Board</b>				
<i>Item</i>	<i>Compaq Spare Part Number</i>	<i>DEC FRU Part Number</i>	<i>Vendor</i>	<i>Description</i>
8	358988-001	30-50481-01	2185B00231A	Replacement Shell without Processor: DC/DC Converter Board Top & Bottom Cover Plastics RTC & Auxiliary Batteries System Board

---

<b>Combo Card—Modem/Ethernet *</b>				
<i>Compaq Spare Part Number</i>	<i>DEC FRU Part Number</i>	<i>Vendor</i>	<i>Description</i>	
358978-001	22-15177-01	6871B9976A1	SPS-Card Combo, NA/Asia Pacific UMI Adapter Connector/Xircom UMI & PC Card doors Combo, Modem/Ethernet, Xircom, NA/Asia	
358978-002	22-15178-01	6871B9976A2	SPS-Card Combo, NA/Asia Pacific UMI Adapter Connector/Xircom UMI & PC Card doors Combo, Modem/Ethernet, Xircom, NA/Europe	

---

\* not illustrated

---

---

### 300-MHz CPU Kit \*

---

<i>Compaq Spare Part Number</i>	<i>DEC FRU Part Number</i>	<i>Vendor</i>	<i>Description</i>
359009-001	22-15181-01	6871B9976A3	SPS-BD System Mod. W/300MHz
	30-50352-01	011N805233A	CPU PenII-300-MHz Mini Cartridge
	30-50353-01	3301BZ9014A	Assy, CPU Cover w/screws (4)
	90-11497-01	1SZBZ3002B	Screw, CPU/Main (4)

\* not illustrated

---

---

### Power Adapters & Power Cords \*

---

<i>Compaq Spare Part Number</i>	<i>DEC FRU Part Number</i>	<i>Vendor</i>	<i>Description</i>
358976-001	30-50408-01	6708BA0001A	AC Adapter, without Power Cord
358936-001	17-04105-01	6410BC11004	Power Cord, US/American
358936-021	17-04105-02		Power Cord, Central European
358936-031	17-04105-03		Power Cord, UK/British
358936-292	17-04105-06	6410BE10701	Power Cord, Japanese
358936-011	17-04105-07	6410BK20301	Power Cord, Australian/New Zealand
358936-AF1	17-04105-09		Power Cord, Singapore

\* not illustrated

---

---

### Docking Options \*

---

<i>Compaq Spare Part Number</i>	<i>DEC FRU Part Number</i>	<i>Vendor</i>	<i>Description</i>
358997-001	30-50414-01	2185B00301A	Expansion Unit

\* not illustrated





---

**Miscellaneous Screw Kit \***

---

<i>Compaq Spare Part Number</i>	<i>DEC FRU Part Number</i>	<i>Vendor</i>	<i>Description</i>
358979-001	22-15179-01	4001B00019A	SPS-Screw Kit Misc Screw, CPU/Main (4) Screw, CPU/Main (4) Screw, LCD Rear Hinge (4) Screw, LCD Front Hinge (4)

*\* not illustrated*

---

**Miscellaneous Plastics Kit \***

---

<i>Compaq Spare Part Number</i>	<i>DEC FRU Part Number</i>	<i>Vendor</i>	<i>Description</i>
358986-001	22-15180-01	3111BZ9025A	SPS-Plastic Kit Misc Left and right hinge covers Front rubber foot Cap, rubber, front 14.1 " XGA Memory door UMI door PC Card door

*\* not illustrated*



---

## 4.4 Preparing the Computer for Disassembly

To prepare the computer for disassembly:

1. Power off the computer and disconnect external power.
2. Remove the main battery (Figures 4-2 and 4-3).
3. Remove any devices installed in the MultiBay (Figures 4-4 and 4-5).

### Removing the Main Battery

To remove the main battery:

1. Turn off the computer and disconnect external power.
2. Turn the computer over so the bottom of the unit is facing up.
3. While depressing the battery near the latch **1**, slide the battery latch to the unlock position **2** (Figure 4-2).

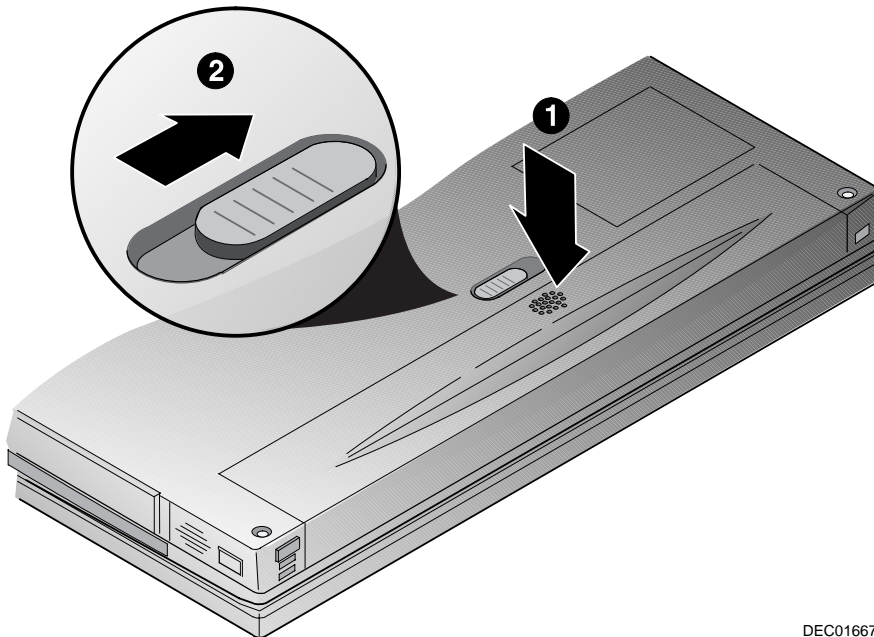
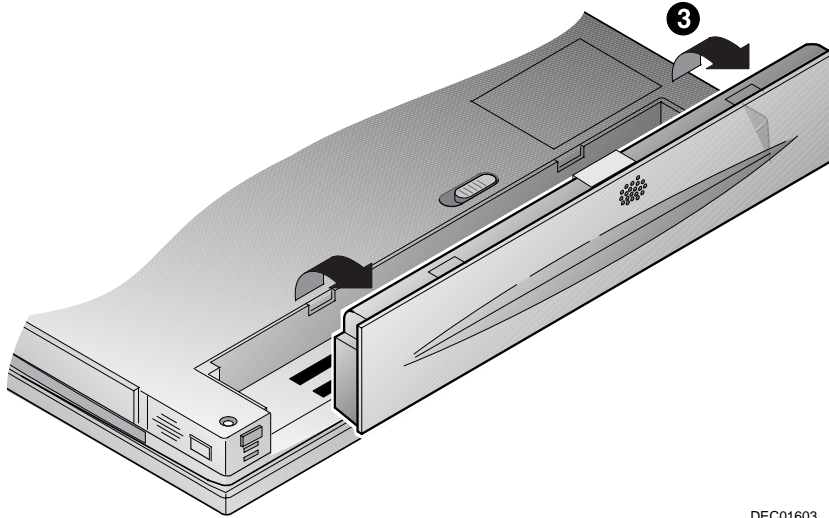

Figure 4-2. Releasing Main Battery

DEC01667

- .....
4. Lift the battery up and out of the computer ③ (Figure 4-3).



**Figure 4-3.** *Removing Battery*

DEC01603

.....

## Removing MultiBay Devices

To remove MultiBay devices:

1. Turn the computer over so the bottom of the unit is facing up.
2. Slide the release latch located on the bottom of the computer to the unlocked position (Figure 4-4).

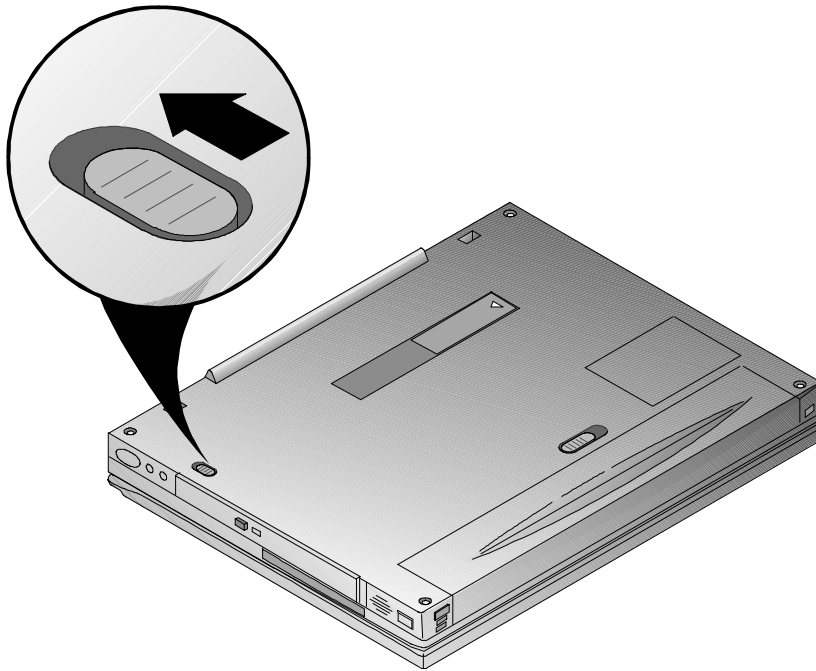

DEC01801-4

**Figure 4-4.** *Releasing MultiBay Devices*

- .....
3. Pull the MultiBay device out of the computer (Figure 4-5).

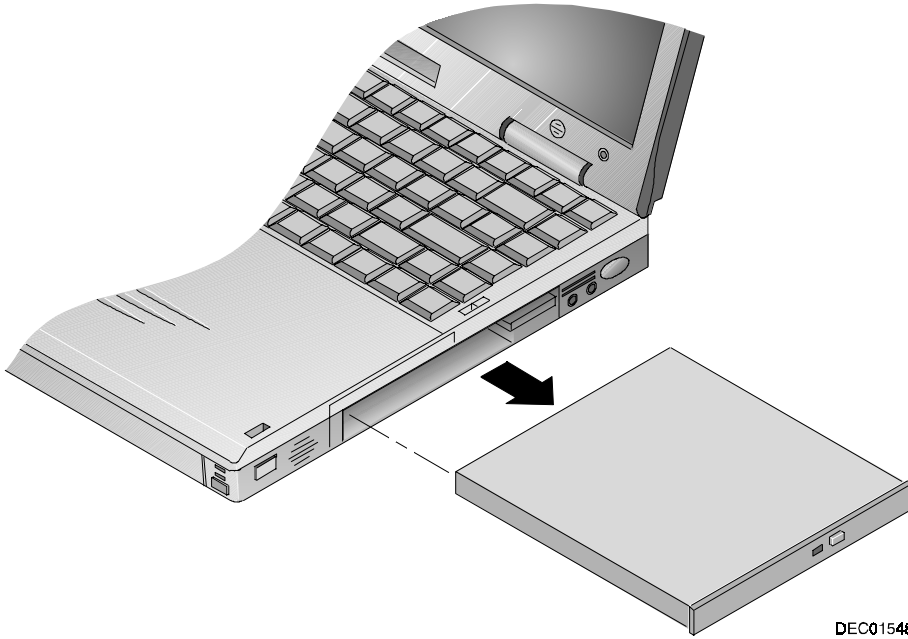

**Figure 4-5.** *Removing MultiBay Devices*

DEC01548-2

.....

## Removing Memory

To remove memory:

1. Save all data and shutdown any running applications.
2. Turn off the computer. Ensure the computer is not in suspend mode.
3. Turn the unit over so the bottom is facing up.
4. Remove the memory compartment cover using a fingernail (Figure 4-6).

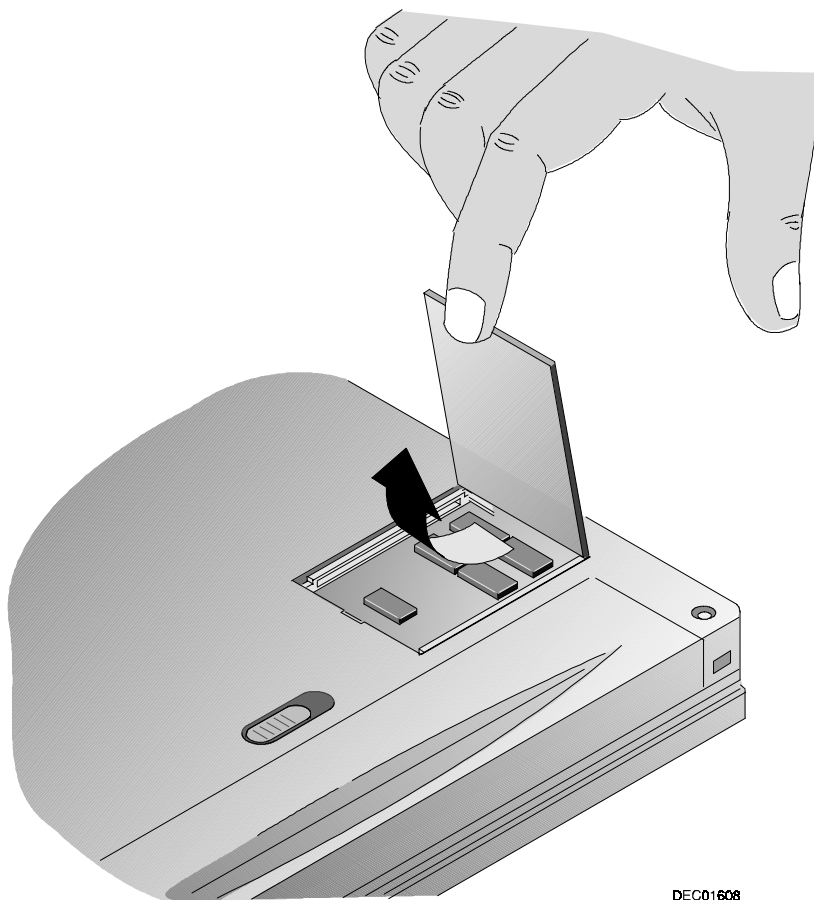

DEC01608

**Figure 4-6.** *Removing the Memory Compartment Cover*

- .....
5. Push the tabs away from the edge of the memory module to be removed ❶. The memory module will pop up at an angle of approximately 45 degrees when released (Figure 4-7).
  6. Lift the memory module out of the slot ❷.
  7. Replace the memory compartment cover and press around the edges to make sure it is properly seated.

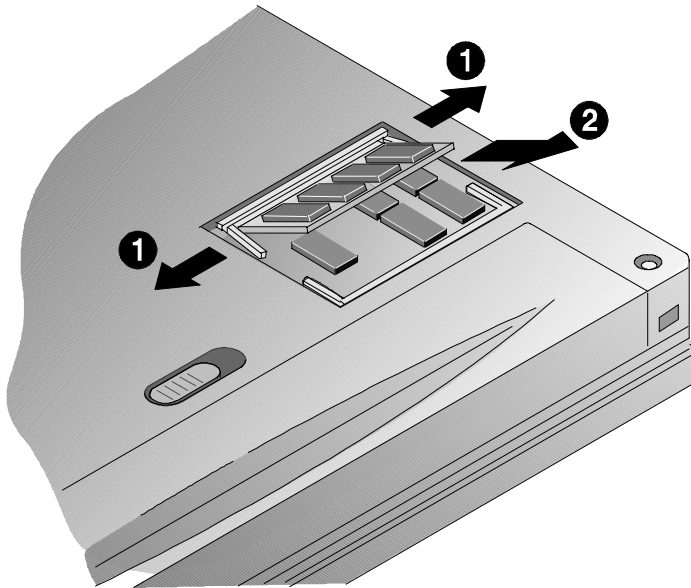

DEC01630

**Figure 4-7.** *Removing Memory Modules*



.....

## *Removing the Internal Modem/Ethernet Combo Card*

To remove the internal modem/Ethernet combo card:

1. Prepare the computer for disassembly.
2. Remove the plastic UMI slot cover (Figure 4-8).

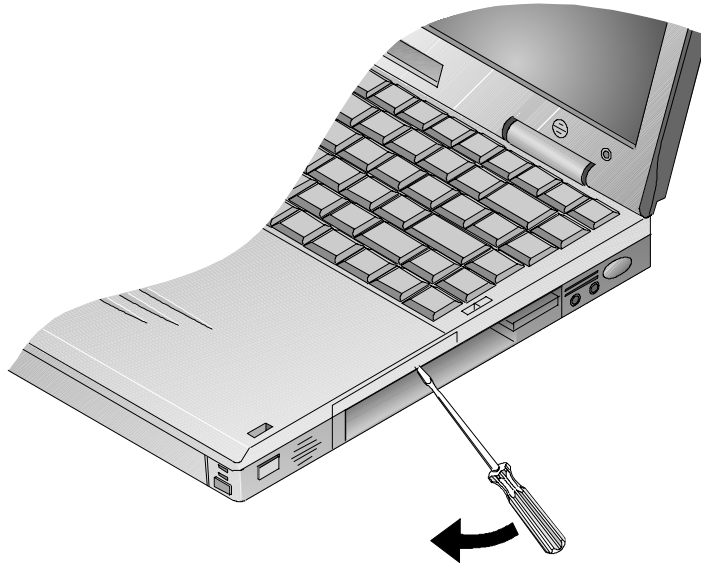

**Figure 4-8.** *Removing the UMI Slot Cover*

- .....
3. Remove the UMI connector (Figure 4-9).



**Figure 4-9.** *Removing the UMI Connector*

- .....
4. Remove the internal Modem/Ethernet Combo Card. Press the eject button using the screw driver or similar device (Figure 4-10, step 1), the internal card will eject (Figure 4-10, step 2).
  5. Remove the Modem/Ethernet Combo Card.



**Figure 4-10.** *Removing the Internal Modem/Ethernet Combo Card*

---

## 4.5 Removing the Keyboard

To remove the keyboard:

1. Prepare the computer for disassembly.
2. Open the display and unlatch the keyboard by sliding the keyboard latches toward the LCD display (Figure 4-11).



**CAUTION:** Opening the display with the battery and MultiBay device removed may cause the computer to flip over.

---

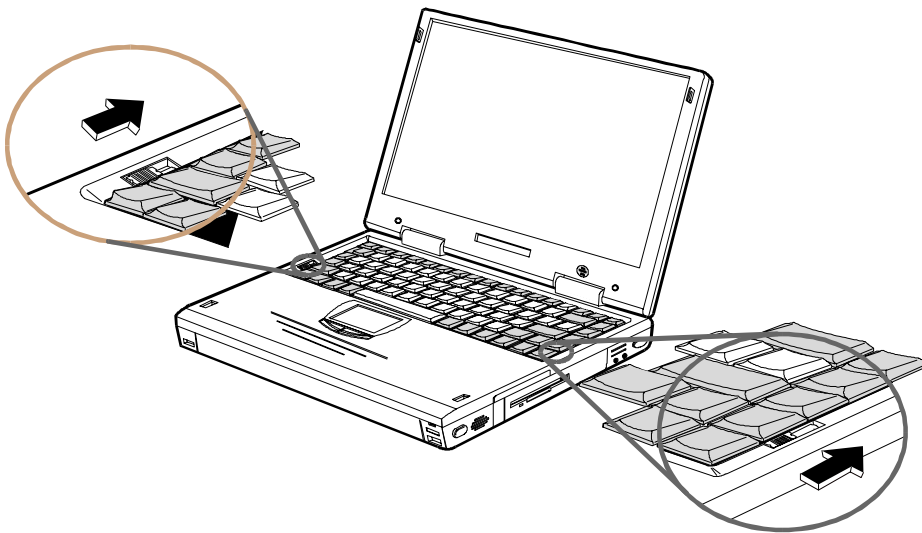

**Figure 4-11.** Releasing the Keyboard Latches

3. Carefully lift the keyboard up and rotate it towards the LCD display (Figure 4-12).



**CAUTION:** Be careful not to damage the flat cables that connect the keyboard to the computer.

---

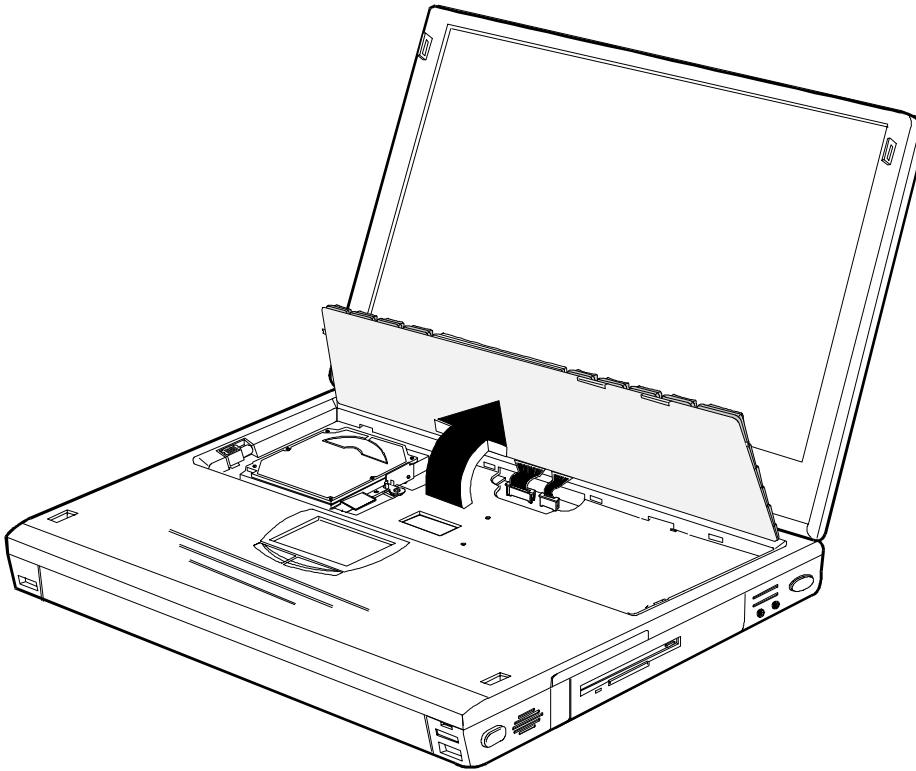

**Figure 4-12.** *Lifting the Keyboard*

- .....
4. Release the keyboard cables from the connectors and slide the cables out of the connectors (Figure 4-13).
  5. Remove the keyboard.

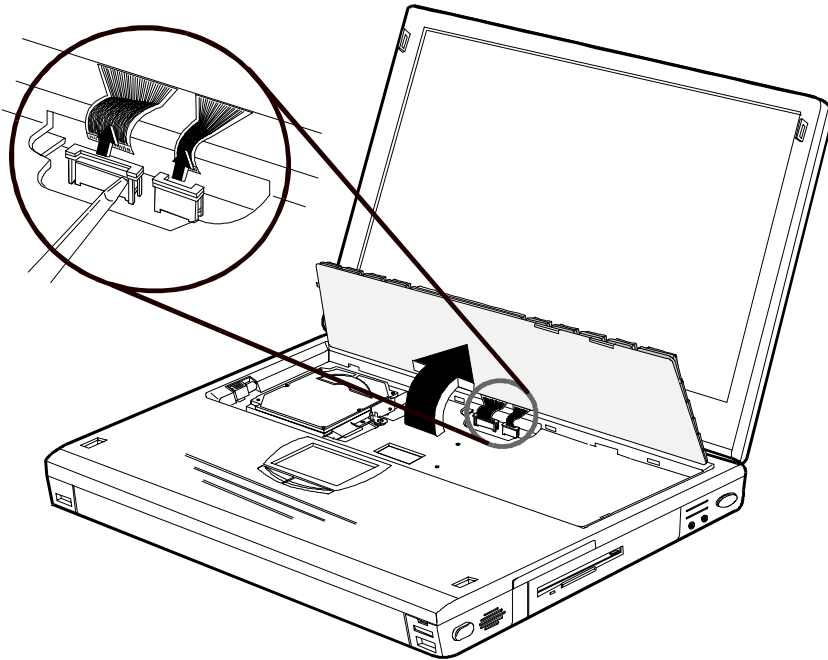

**Figure 4-13.** *Disconnecting the Keyboard Cables*

.....

## 4.6 Removing the Hard Drive Assembly

To remove the hard drive:

1. Prepare the computer for disassembly.
2. Remove the keyboard (Figures 4-11 through 4-13).
3. Slide the latch that holds the hard drive in place to the unlocked position (Figure 4-14, step 1).
4. Pull up on the attached ribbon loop to disconnect the drive (Figure 4-14, step 2).
5. Remove the drive from the system.



**Figure 4-14.** Removing the Hard Drive

.....

## 4.7 Removing the LCD Assembly

To remove the LCD assembly:

1. Prepare the computer for disassembly.
2. Close the LCD Display and remove the two hinge covers. To remove the hinge covers:
  - a) Use a small pointed tool such as a pair of tweezers to release the inside edge of the hinge cover.
  - b) Release the rest of the hinge cover and wiggle it to remove the hinge cover. The left and right hinge covers are different.
3. Remove the four Philips-head hinge screws located below the hinge position (Figure 4-15).

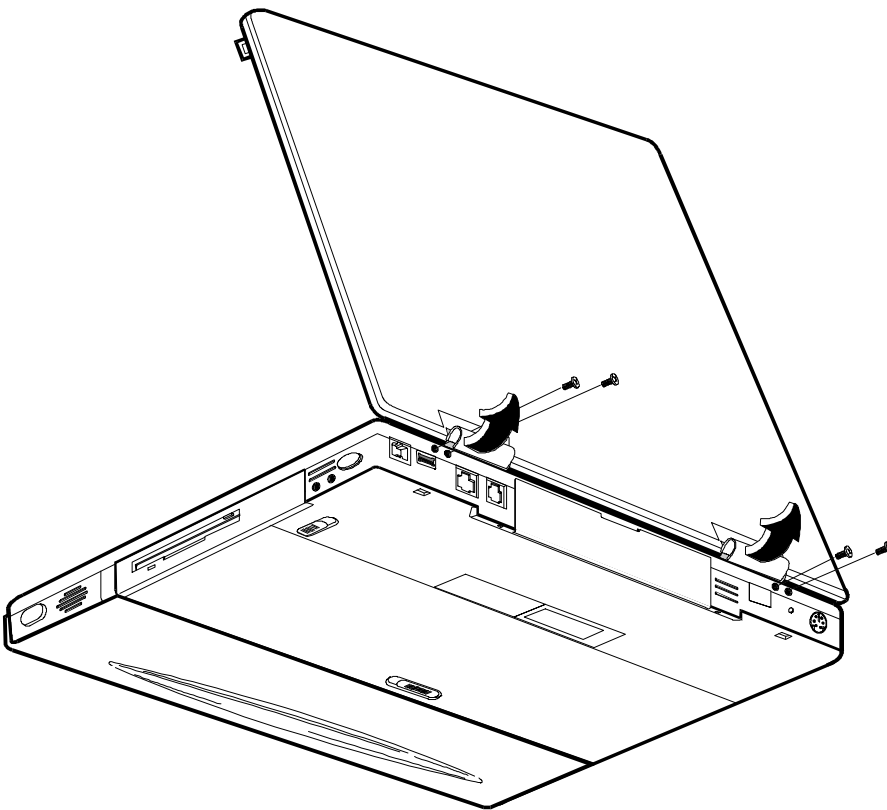
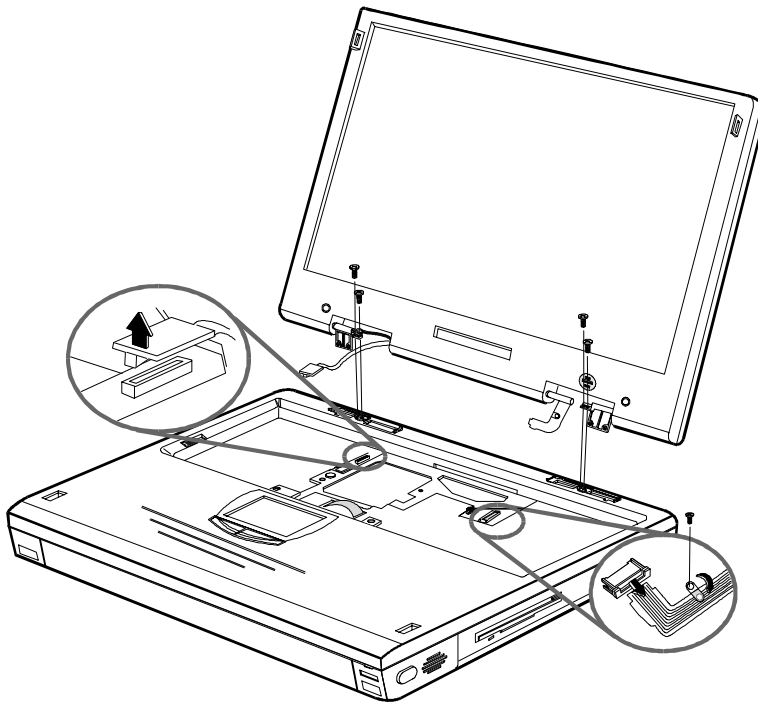

**Figure 4-15.** Removing LCD Hinge Cover and Rear Hinge Screws

4. Open the LCD Display.



- .....
5. Remove the four Philips-head hinge screws located on the top of the hinges (Figure 4-16).
  6. Disconnect the IR/Reset cable to allow easy access to the power cable connector.
  7. Disconnect the panel power cable from its main board connector.
  8. Disconnect the panel signal cable by removing the screw securing the cable to the thermal plate and sliding the cable out of its connector.



**Figure 4-16.** *Removing the LCD Assembly*

9. Lift the panel away from the base just enough to free the hinges and allow the panel to lay behind the computer. It may be helpful to place the battery under the panel to reduce stress on the cables.
10. Carefully route the free end of the power cable through the housing until it is free.
11. Carefully route the free end of the signal cable through the housing until it is free.

---

## 4.8 CPU Base Enclosure with System Board Replacement

The Armada 6500 series computer CPU Base Enclosure with System Board is supplied for field replacement by an Authorized Service Provider. This spare part assembly minimizes field repair time for a customer's unit when symptoms are diagnosed to the system board or other components inside. Refer to the Armada 6500 Maintenance and Service Guide for complete service information.

**NOTE:** Sufficient ESD protection, a clean work surface, a small flat head screw driver, a plastic wedge hand tool, and a #1 Phillips head screw driver are needed. There are several different screw sizes and shapes encountered during this disassembly; make sure to label and separate them for correct reinstallation.

1. There should be a paper label supplied on the bottom of the replacement CPU Base Enclosure with System Board. Enter all appropriate information from the unit. This information is necessary for warranty, service, and tracking purposes.
2. Perform the level of disassembly of the customer unit according to the enclosed instructions.
3. Attach a failure tag or note, to the defective CPU Base Enclosure with System Board, identifying the failure mode and return it as directed, complete and packaged well.

### Disassembly Instruction



**CAUTION:** It is not recommended to disassemble a failed unit until the replacement "CPU Base Enclosure with System Board" is received and available for immediate use. Part removal and installation should be performed in a single operation to ensure all the correct size and shapes of the various screws are used.

---

The following parts, along with all hold down screws, will be removed and retained for use on the replacement enclosure.

- Primary battery
- Diskette, CD-ROM, or DVD-ROM drive, which ever is installed
- Keyboard
- Hard disk drive
- Entire display assembly with hinges
- CPU heat sink/cover plate
- CPU card
- UMI cover
- UMI adapter
- Modem/ENet card
- Memory daughter cards
- PC Cards
- Plastic hinge covers

.....

The enclosure that is returned must contain have all the other parts not removed in this section. Failure to comply may result in the enclosure being returned with an additional charge for shipping. Please follow these directions to minimize customer unit downtime and maximize customer satisfaction.

1. Make sure the unit is fully powered down. Remove the primary battery.
2. Remove the diskette drive, DVD-ROM drive, or CDROM drive assembly, whichever is installed.
3. Slide the keyboard latches. Raise the keyboard toward the display.
4. Disconnect the keyboard cables by unlocking the connectors on the system board and carefully pulling the cables out of the connectors.
5. Remove the keyboard.
6. Slide the hard drive assembly latch handle to the unlocked position. Pull the ribbon handle to remove the hard drive from the base.
7. With the unit closed, remove the two display hinge covers carefully with a plastic wedge shaped tool.
8. From the back of the unit, remove the 4 screws attaching the display hinges to the base. Open the unit and remove 4 more screws connecting the display hinges to the base.
9. Remove the small grounding screw inside the right side of the unit that holds down the display cable. Disconnect the other display cables from the system board. Remove the display assembly. Carefully bend (but do not damage) and slide the cables through the openings in the chassis.
10. Remove the screws securing the CPU heat sink plate. Remove the screws securing the CPU assembly. Lift the CPU assembly straight up by prying up with a plastic tool from the cutout on the right side. Protect the CPU connector pins until it is installed in the replacement enclosure.
11. Remove the "L" shaped UMI cover located on the right side of the unit with the plastic tool.
12. Unplug the "L" shaped UMI adapter connecting the Modem/ENet card to the base unit.
13. Press the eject button to remove the UMI PC card. Check for cards in the two other PC Card slots and for memory daughter cards on the system board. Remove any that are installed.

.....

## Customer System Reconfiguration

1. Install the parts removed from the defective computer onto the replacement CPU Base Enclosure with System Board.
2. Enter all required information on the service tag attached to the bottom of the replacement CPU Base Enclosure with System Board. Obtain all original information from the service tag on the unit being repaired. Figure 4-17 shows a service tag.
3. Remove the protective paper from the clear covering of the service tag and seal the tag.

**COMPAQ**

This part was exchanged by a Compaq Authorized Service Provider per the information filled in below.

Original Serial No.:

Original Model No.:

Call log # / Part Order #  Date:

36-49198-02

**Figure 4-17.** CPU Base Enclosure with System Board Identification Label (36-49198-02)

# Specifications

## System Specifications

<i>System Feature</i>	<i>Model</i>
	<b>G7X6300MD - 6GB - 14.1"</b>
CPU Intel Pentium II	300 MHz MMX
LCD	14.1" XGA TFT
HDD	6 GB
Upgradeable HDD	Yes
L2 Cache	512KB
Base RAM	64MB – SDRAM 3.3v
Maximum RAM	192MB or greater
RAM Expansion	Dual 144 pin SO–DIMM 3.3v self-refresh

## Hardware Specifications

<i>Feature</i>	<i>Model</i>
	<b>G7X6300MD - 6GB - 14.1"</b>
Battery	Lilon – 12 cell 54Whrs
Audio	Yes
CardBus/Zoomed Video	Supported
Fast IR (4 Mbps)	Yes
Integrated CD-ROM	24X
Integrated 56K Modem and 10/100BaseT Ethernet (standard on selected models)	Yes
Pointing Device	Touch pad
Armada 6500 Convenience Base	Optional
Mobile 6500 Expansion Unit	Optional

---

## Physical Specifications

<i>Feature</i>	<i>Model</i> <b>GTX6300MD - 6GB - 14.1"</b>
Size	9.7" x 12" x 1.4"
Weight (no FDD or CD-ROM in bay)	5.96 lbs. (approximate)
Weight (FDD in bay)	6.27 lbs. (approximate)
Weight (CD-ROM in bay)	6.46 lbs. (approximate)
Operating System	Windows 95, Windows 98 or Windows NT 4.0
Warranty	3 years

## Environment

<i>Parameter</i>	<i>Value</i>
Temperature	
Operating	32 to 95 degrees F (0 to 35 degrees C)
Non-operating	32 to 95 degrees F (0 to 35 degrees C)
Relative humidity	
Operating	20% to 80%, non-condensing
Non-operating	20% to 80%, non-condensing
Altitude	
Operating	Sea level to 8,000 ft (3,040m)
Non-operating	Sea level to 40,000 ft (12,160m)
Shock	
Operating	10G for 11 ms half sine
Non-operating	100G for 11 ms half sine

# Device Mapping

## Memory Map

Range	Name	Function
0h to 9FFFFh	640KB System Memory	System Memory Space
A0000h to BFFFFh	128K Video Memory	Graphics Display Memory Buffer
C0000h to CAFFFh	44KB Video BIOS ROM	Shadow BIOS of VGA
CC000h to CD7FFh	6K CD Boot ROM	CD Boot
CD800h to CDFFFh	2K EPP Bios	Enhance Parallel Port
E8000h to FFFFFh	96KB PCI, PnP, and System ROM	BIOS of System
100000h to 8FFFFFFFh	Additional Memory Space	Extended Memory Space, Size from 8MB up to 144MB

## DMA Channel Assignments

Channel	Controller	Function
0	1	Parallel Port ECP (if enabled)
1	1	Sound
2	1	Diskette controller
3	1	Serial IR (if enabled)
4	2	Cascade DMA
5	2	Not used
6	2	Not used
7	2	Not used

---

## Notebook Computer Interrupt Levels

<b>IRQ</b>	<b>Normal Assignments (FIS)</b>
0	System Timer
1	Keyboard
2	Cascade
3	UMI/IrDA defaults to COM2, but is disabled
4	Serial Port COM1
5	Audio
6	Floppy Disk Controller
7	Parallel Port LPT1
8	Real Time Clock
9	ACPI
10	PCI CardBus Controller
11	USB and Video
12	Track Pad, PS/2 Mouse
13	Numeric Data Processor
14	Primary IDE-Hard Disk Controller
15	Secondary IDE-Mobile 6500 Expansion Unit



---

## I/O Address Map

<b>Range (hexadecimal)</b>	<b>Function</b>
000 - 00F	DMA controller A
020 - 021	Master interrupt controller
024	Index register - system board
026	Data register - system board
040 - 043	Interval timer
060 - 06F	Keyboard controller
070 - 07F	Real-time clock (RTC), NMI
080 - 08F	DMA page register
0A0 - 0A1	Slave interrupt controller
0C0 - 0CF	DMA controller B
0F0	Clear math coprocessor
0F1	Reset math coprocessor
0F8 - 0FF	Math coprocessor
150 - 157	ESS 1878 control interface
170 - 177	Secondary IDE controller
1F0 - 1F7	IDE controller
201	MIDI/Joystick
220-22F	On-board Audio (ESS 1878)
278 - 27F	LPT2
2E8 - 2EF	COM4
2F8 - 2FF	COM2
330-331	MPU 401 Audio
378 - 37F	LPT1
388 -38B	FM synthesizer Audio
3B0 - 3BB	Mono VGA registers
3BC - 3BE	LPT3
3C0 - 3CF	VGA registers
3D0 - 3DF	Color VGA registers
3E0 - 3E1	PCMCIA controller
3E8 - 3EF	COM 3
3F0 - 3F7	Diskette controller
3F6 - 3F7	IDE controller (alt status, device address)
3F8 - 3FF	COM1
CF8 - CFF	Cardbus PCI port interface

\*Enabled and disabled using the Setup Utility or Windows 95

---

# Index

## A

- Addresses, I/O Address Map, B-3
- Audio, 1-4
  - stereo audio output jack, 1-8
- Audio Failure, 3-9
- Audio Out
  - description, 1-8

## B

- Battery, 3-3, 3-8
  - charge indicator, 1-8
  - maximizing battery life (key), 1-16
  - removing, 4-7
- Battery release
  - description, 1-13
- Beep Codes, 3-9
- BIOS, 1-3, 1-5, 2-1, 3-9
  - Restoring, 2-13
- BIOS Test Points, 3-9

## C

- Caps lock, 1-15
- Cardbus Controller, 1-3
- CD-ROM drive, 3-7
- Chip Set, 1-2
- computer
  - configuring, 2-1
- configuring your computer, 2-1
- Controlling Power
  - In Windows 95, Windows 98 and Windows NT, 1-14
- Controls and indicators, 1-8
- CPU, 1-1

## D

- Device mapping
  - DMA channel assignments, B-1
  - I/O address, B-3
  - interrupt levels, B-2
  - memory map, B-1
- disk, 3-6, 3-7
- diskette drive, 3-7
- Docking Connector
  - description, 1-13
- Docking Options, 1-7
- Docking Security
  - password on undock, 2-10
- Docks
  - Armada 6500 Convenience Base, 1-7
  - Mobile 6500 Expansion Unit, 1-7
- Documentation, 1-18

## E

- Embedded numeric keypad
  - LCD status display, 1-15
- Environment, A-2
- Error Messages, 3-9
- Ethernet Network Port
  - description, 1-12
- Expansion Bay, 1-8
  - description, 1-8
- Expansion Bay Module Release
  - description, 1-13
- External display port
  - enabling/disabling (key), 1-16
- External Power In
  - description, 1-12

## F

- Fast IR port
  - description, 1-12
- Field Replacable Units. *See* FRU
- FRU, 4-1
- FRU replacement, 4-1
- Functional Description
  - Audio, 1-4
  - BIOS, 1-3, 1-5
  - Cardbus Controller, 1-3
  - ISA Bus Devices, 1-4
  - Memory, 1-2
  - System Command Processor, 1-5
  - UMI Controller, 1-6
  - Video, 1-4
- Functionl Description
  - Chip Set, 1-2
  - CPU, 1-1
  - I/O Ports, 1-6
  - PCI Bus Devices, 1-3

## H

- Hard disk drive
  - LCD status display, 1-15
  - timer parameters, 2-11
- hard drive, 3-6
  - removing, 4-19
- Hardware Specifications, A-1
- Headphones
  - stereo audio output jack, 1-8
- Hot Keys. *See* Keyboard Keys

I/O Ports, 1-6  
Indicators  
    control and indicators, 1-8  
    LCD status display, 1-15  
Infrared  
    transmitter/receiver port,  
    1-8  
Internal Microphone  
    description, 1-8  
Internal Modem/Ethernet  
    Combo Card  
    removing, 4-13  
Internal Modem/Network,  
    3-8  
Interrupts  
    levels, B-2  
ISA Bus Devices, 1-4

## K

Keyboard, 3-6  
    external keyboard  
    connector, 1-8  
    removing, 4-16  
Keyboard keys  
    controlling LCD display  
    brightness, 1-16  
    enabling/disabling display  
    port/LCD display, 1-16  
    enabling/disabling speakers,  
    1-16  
    escape key, 1-16  
    function keys, 1-16  
    hot keys, 1-16  
    maximizing battery life,  
    1-16  
    maximizing performance,  
    1-16  
    placing computer in setup  
    mode, 1-16  
    placing computer in  
    standby mode, 1-16  
    toggling on and off NUM  
    lock, 1-16

Keyboard Releases  
    description, 1-10  
Keyboard/Mouse port  
    description, 1-12  
Keypad  
    LCD status display, 1-15

## L

LCD Assembly  
    removing, 4-20  
LCD display  
    AC power, 1-15  
    Battery Power, 1-15  
    Caps lock, 1-15  
    displaying operating status,  
    1-8  
    Embedded numeric keypad,  
    1-15  
    enabling/disabling (key),  
    1-16  
    Hard Drive/System  
    Expansion Bay Activity,  
    1-15  
    Monitor, 1-15  
    NUM lock, 1-15  
    Scroll lock, 1-15  
    Standby mode, 1-15  
    status display, 1-15  
LCD display brightness  
    controlling, 1-16  
LCD Panel, 3-5  
Lid release, 1-8  
    description, 1-8, 1-10  
lid switch  
    controlling power, 1-14

## M

Mapping  
    device memory mapping,  
    B-1  
    I/O address map, B-3  
Memory, 1-2  
    removing, 4-11  
Memory door  
    description, 1-13  
Memory mapping  
    device memory mapping,  
    B-1

Messages, 3-9  
    warning, 3-14  
Microphone In  
    description, 1-8  
Modem Port  
    description, 1-12  
Modules, 1-7  
Monitor  
    LCD status display, 1-15  
Mouse  
    external mouse connector,  
    1-8  
Mouse port  
    description, 1-12  
Mouse/Keyboard port  
    description, 1-12  
MultiBay devices  
    removing, 4-9  
Multimedia, 1-7

## N

NUM lock  
    LCD status display, 1-15  
    toggling on and off, 1-16  
Numeric, embedded keypad  
    LCD status display, 1-15

## O

On-Line Information, 1-18  
Options, 1-7  
overview, 1-1

## P

Parallel Port  
    description, 1-12  
Passwords, 2-8  
PC Card ejectors  
    description, 1-10  
PC Card slots  
    description, 1-10  
PC Cards Slots, 1-8  
PCI Bus Devices, 1-3  
Performance  
    maximizing performance  
    (key), 1-16  
Physical Specifications, A-2  
Port 80h, 3-9

- Ports
  - Ethernet Network, 1-12
  - External Power In
    - description, 1-12
  - Fast IR port description, 1-12
  - Infrared transmitter/receiver port, 1-8
  - Keyboard/Mouse port
    - description, 1-12
  - Modem port, 1-12
  - Mouse port description, 1-12
  - Mouse/Keyboard port, 1-12
  - Parallel port, 1-12
  - security lock description, 1-10
  - Serial port description, 1-12
  - Video port description, 1-12
- POST, 3-9
- Power
  - AC power status, 1-15
  - external power connector, 1-8
- Power Supply Failure, 3-3
- Power/Charging LEDs
  - description, 1-8

## R

- Removable Hard Drive
  - description, 1-10
- removal and replacement preliminaries, A-1, B-1
- removing memory modules, 4-11
- removing MultiBay devices, 4-9
- Removing the battery, 4-7
- removing the hard drive, 4-19
- Removing the Internal Modem/Ethernet Combo Card, 4-13
- Removing the Keyboard, 4-16
- Removing the LCD Assembly, 4-20
- Reset button, 1-12

- description, 1-8
- location, 1-8
- Restoring the Flash BIOS, 2-13
- Running Setup
  - help hints, 2-3
  - launching submenus, 2-3

## S

- Scroll lock
  - LCD status display, 1-15
- security, 2-8
  - password on undock, 2-10
  - supervisor password, 2-8, 2-10
  - user password, 2-9, 2-10
- Security lock
  - description, 1-10
- serial number, x
- Serial Port
  - description, 1-12
- Service Options, 4-1
- Setup menus
  - Advanced Menu, 2-5
  - Boot Menu, 2-12
  - Exit Menu, 2-13
  - Main Menu, 2-4
  - Power Menu, 2-11
  - Security Menu, 2-7
- Setup mode, entering (key), 1-16
- Speakers
  - description, 1-8, 1-10
  - enabling/disabling speakers, 1-16
  - stereo audio output jack, 1-8
- Specifications, A-1, A-2
  - Environment, A-2
- Standby mode
  - escape key, 1-16
  - LCD status display, 1-15
- Status
  - displaying operating status, 1-8
- Status Display. *See* LCD Display
  - description, 1-8
- Supervisor password, 2-8

- deleting, 2-10
- Suspend, 1-14
  - suspend/power, 1-14
- Suspend/Power Button
  - controlling power, 1-14
  - description, 1-8
  - location, 1-8
- System BIOS, 2-1
- System Command Processor, 1-5
- System Setup, 2-1
  - configurable features, 2-2
  - Defaults, 2-13
  - running, 2-1
- System Setup Program, 2-11
- System Specifications, A-1, A-2
- System Start Failure, 3-2

## T

- technician notes, ix
- Test Points, 3-9
- Touchpad, 3-8
- Troubleshooting
  - Touchpad Failure, 3-8
- Troubleshooting, 3-1
  - Audio Failure, 3-9
  - Battery, 3-8
  - Boot Failure, 3-4
  - Cardbus Failure, 3-4
  - CD-ROM, 3-7
  - disk, 3-6
  - diskette drive, 3-7
  - External Keyboard/Mouse, 3-6
  - Internal Modem/Network, UMI, 3-8
  - Keyboard, 3-6
  - LCD Panel, 3-5
  - Monitor, 3-5
  - Post Failure, 3-4
  - Power Supply, 3-3
  - System Start Failure, 3-2
  - Tips, 3-1
- turning off the computer, 1-14
- turning on the computer, 1-14



U

- UMI, 3-8
- UMI Controller, 1-6
- User password, 2-9
  - deleting, 2-10

V

- Video, 1-4
- Video port
  - description, 1-12

W

- warning messages, 3-14